

FieldFox C-Series RF Handheld Analyzers

4/6.5/10/14 GHz

N9912C

N9913C

N9933C

N9914C

N9934C

N9915C

N9935C

Introduction

The Keysight's new C-Series RF FieldFox handheld analyzers, led by the N9912C, offers the software-defined configuration to cover frequency of 3 kHz up to 4, 6.5, and 10 GHz. This data sheet summarizes their performance, as a vector network analyzer, a cable antenna analyzer, and/or a spectrum analyzer.



dataTec

Ihr Ansprechpartner /
Your Partner:

dataTec AG
E-Mail: info@datatec.eu
>>> www.datatec.eu

 **KEYSIGHT**
Authorized Premium
Distributor

Table of Contents

Definitions.....	3
Cable and Antenna Analyzer (CAT) and Vector Network Analyzer (VNA)	4
Corrected Measurement Uncertainty	13
TDR Cable Measurements (Option 215)	18
VNA Time Domain (Option 010)	19
Mixed-Mode S-Parameters (Option 212)	19
Vector Voltmeter (VVM) (Option 308)	20
Spectrum Analyzer (Option SAx on N9912C or Option 233 on Combination Analyzers)	21
I/Q Analyzer (IQA) (Option 351).....	36
Spectrum Analyzer IF Output.....	45
Preamplifier (Option 235).....	45
Interference Analyzer and Spectrogram (Option 236)	46
Channel Scanner (Option 312)	46
Over-the-Air (OTA) LTE FDD/TDD (Option 370/371)	48
Over-the-Air (OTA) 5G NR (Option 378).....	50
EMF Measurements (Option 358).....	54
AM/FM Analog demodulation, Tune and Listen (Option 355).....	55
Spectrum Analyzer Time Gating (Option 238)	56
Reflection Measurements (RL, VSWR) (Option 320, applicable to SA only models).....	56
Extended Range Transmission Analysis (ERTA) (Option 209)	57
Built-in Power Meter (Option 310).....	59
External USB Power Sensor Support (Option 302)	60
Pulse Measurements (Option 330)	60
USB Power Sensor Measurements versus Frequency (Option 208)	61
Built-In GNSS (GPS+) Receiver (Option 307)	63
DC Bias Variable-Voltage Source (Option 309).....	63
Remote Control Capability (Option 030)	64
General Information	67
FieldFox Physical Dimensions	71
Confidently Covered by Keysight Services	72

This data sheet provides the specified and typical performance of the FieldFox family of portable analyzers. This data sheet should be used in conjunction with the technical overviews and configuration guide, for a complete description of the analyzers.

The specifications and measurement capabilities listed in this document require certain options on the FieldFox analyzer. Refer to the FieldFox Configuration Guide to obtain option information. The configuration guide is the main resource for option/measurement capability information (<https://www.keysight.com/us/en/assets/7018-06515/configuration-guides/5992-3701.pdf>).

Definitions

Specification (spec)

Specifications include guard bands to account for the expected statistical performance distribution, measurement uncertainties, and changes in performance due to environmental conditions. Specifications are warranted performance. FieldFox must be within its calibration cycle. No warm-up required for the specifications listed on pages 21 through 64.

Typical

Describes additional product performance information not covered by the product warranty. It is performance beyond specifications that 80% of the units exhibit with a 90% confidence level over the temperature range 23 ± 5 °C, unless otherwise noted. Typical performance does not include measurement uncertainty. FieldFox must be within its calibration cycle.

Nominal

A general, descriptive term or design parameter. It is not tested, and not covered by the product warranty. FieldFox must be within its calibration cycle.

Cable and Antenna Analyzer (CAT) and Vector Network Analyzer (VNA)

The performance listed in this section applies to the cable and antenna analyzer (referred to as CAT) and vector network analyzer (VNA) capabilities available in the following models:

Description	Model number
FieldFox RF & microwave (combination) analyzers	N9912C, N9913C, N9914C, N9915C

NOTE: Combination analyzers = Cable and antenna tester (CAT) + Vector network analyzer (VNA) + Spectrum analyzer (SA)

See [FieldFox Configuration Guide](#) for option information. Many capabilities listed in this Data Sheet require options.

Frequency specifications

	Models	Frequency range
N991xC	N9912C	3 kHz to 4/6.5/10 GHz
	N9913C	3 kHz to 4 GHz
	N9914C	3 kHz to 6.5 GHz
	N9915C	3 kHz to 10 GHz

Frequency reference, -10 to 55 °C

Accuracy	± 0.9 ppm (spec) + aging ± 0.5 ppm (typical) + aging
Accuracy, when locked to GPS	± 0.010 ppm (spec)
Accuracy, when GPS antenna is disconnected	± 0.4 ppm (nominal) ¹
Aging Rate	± 1 ppm/yr for 20 years (spec), will not exceed ± 3.5 ppm
Frequency resolution	Specification
3 kHz to 1.49961 GHz	0.34 Hz
> 1.49961 to 2.99961 GHz	0.67 Hz
> 2.99961 GHz to 5.99961 GHz	1.34 Hz
> 5.99961 GHz to 10 GHz	2.68 Hz

Data points or resolution

101, 201, 401, 601, 801, 1001, 1601, 4001, 10,001
Arbitrary number of points settable through front panel and SCPI

IF bandwidth²

3 Hz, 10 Hz, 30 Hz, 100 Hz, 300 Hz, 1 kHz, 3 kHz, 10 kHz, 30 kHz, 100 kHz

System impedance

50 Ω (nominal), 75 Ω with appropriate adapter and calibration kit

¹ The maximum drift expected in the frequency reference applicable when the ambient temperature changes ±5°C from the temperature when the GPS signal was last connected.

² VNA mode only. Recommend using averaging in CAT mode.

Test port output specifications

High power in the N991xC refers to the analyzer's target output power level when the Power Setting is High. An example:

- N991xC: For a 58.4 MHz to 10 GHz frequency sweep, the analyzer achieves an 8 dBm power level across the band.

Low power level for N991xC analyzers flattens at -50 dBm across the entire frequency band and is the analyzer's output when the Power Setting is Low.

Max leveled power in the N991xC refers to the maximum leveled (flattened) power achieved across the designated frequency range. An example:

- N991xC: For a 58.4 MHz to 10 GHz frequency sweep with the analyzer configured to measure all four S-parameters, needing both ports 1 and 2, the maximum power the analyzer can be set to is 7 dBm.

Test port output power (dBm), high power	Typical	
N991xC	Port 1 or Port 2	
3 kHz to 50 kHz	-12	
> 50 kHz to 150 kHz	-6	
> 150 kHz to 300 kHz	-2	
> 300 kHz to 800 kHz	0	
> 800 kHz to 3.45 MHz	2	
> 3.45 MHz to 58.4 MHz	5	
> 58.4 MHz to 10 GHz	8	
Test port output power (dBm), low power	Typical	
N991xC	Port 1 or Port 2	
3 kHz to 10 GHz	-50 dBm (flattened) ± 0.5 dB	
Max leveled output power (dBm)	Nominal	Nominal
N991xC	Port 1	Port 2
> 3.45 MHz to 58.4 MHz	5	5
> 58.4 MHz to 10 GHz	8	7

Output power range

CAT	High, low, and manual. Default (preset) power is manual, -15 dBm. Manual power is flattened.
VNA	High, low, and manual. Default (preset) power is manual, -15 dBm. Manual power is flattened.

Power step size

Power settable in 1 dB steps across power range. Flat power, in 1 dB steps, is available across the whole frequency span, nominal.

Power level accuracy ¹	Typical
N991xC	Port 1 or Port 2 at -20 dBm
3 kHz to 300 kHz	± 0.6 dB
> 300 kHz to 10 GHz	± 0.5 dB
Power level linearity	Nominal
N991xC	Port 1 or Port 2, -50 dBm ≤ P < max leveled power
> 10 MHz to 10 GHz	± 0.45 dB

System performance specifications

System dynamic range^{2,3} (dB), high power, 300 Hz IFBW, 100-point average, Port 1 or Port 2 (-10 to 55°C)

Frequency	S12 Spec	S12 Typical	S21 Spec	S21 Typical
3 kHz to 30 kHz	-	86	-	87
> 30 kHz to 1 MHz	-	110	-	115
> 1 MHz to 10 MHz	102	117	101	116
> 10 MHz to 4 GHz	106	118	103	118
> 4 GHz to 6.5 GHz	104	117	104	120
> 6.5 GHz to 10 GHz	104	116	102	117

Measurement stability over temperature

N991xC	Frequency	Nominal	
		Magnitude (dB/°C)	Phase (deg/°C)
	3 kHz to 100 kHz	± 0.6	± 2.9
	> 100 kHz to 10 GHz	± 0.011	± 0.4

Measurement speed (Sweep time)

CAT	N991xC
Return loss, 3 kHz to 10 GHz, 1-port cal, 1001 points	461 μs/pt
Distance-to-fault, 100-meter cable, 1-port cal, 1001 points	512 μs/pt
VNA	N991xC
S11 and S21, 30 kHz to 10 GHz, enhanced response cal, 100 kHz IF bandwidth, 1001 points	200 μs/pt

¹ Power levels are calibrated based on PNA-X tuned receiver for the entire frequency range.

² System dynamic range is measured in the factory with loads on the test ports after a thru normalization.

³ For CAT mode, "Insertion loss (2-port)", decrease listed dynamic range specifications by 20 dB, as CAT mode IFBW is fixed at 10 kHz. Can obtain full dynamic range by using S21 measurement in VNA mode with 100 Hz IFBW.

Trace noise, high power, 300 Hz IFBW, Port 1 or Port 2

Specifications (-10 to 55°C)

N991xC	Frequency	Magnitude (dB rms)	Phase (deg rms)
	3 kHz to 50 kHz	0.0052 ¹	0.072 ¹
	> 50 kHz to 5 GHz ²	0.0011	0.011
	> 5 GHz to 10 GHz	0.0015	0.015

Receiver compression		Typical
N991xC	Frequency	Port 1 or Port 2
	250 kHz to 1.25 GHz	+8 dBm, 0.20 dB compression
	> 1.25 GHz to 5 GHz	+8 dBm, 0.15 dB compression
	> 5 GHz to 10 GHz	+8 dBm, 0.10 dB compression

Maximum input level		Port 1 or Port 2
N991xC	Average CW power	DC
	+25 dBm, 0.3 watts	±40 VDC

Immunity to interfering signals		
N991xC		Nominal
On carrier frequency		+7 dBm
Offset from carrier frequency	> 1 MHz	+7 dBm
	> 10 MHz	+10 dBm

¹ Typical values, 10 Hz IFBW.

² Excludes frequency range between 5 MHz and 25 MHz.

CAT and VNA measurements

CAT mode	
CAT measurements	Distance-to-fault (dB), Distance-to-fault (Lin) Return loss (dB) Return loss & DTF (dB) VSWR Distance-to-fault (VSWR) Cable loss (1-port) Insertion loss (2-port) (requires option 211) TDR (Lin rho) (requires option 215), TDR (ohm) (requires option 215) TDR & DTF (requires option 215)
Distance-to-Fault (DTF) settings	
Frequency/distance	Start distance, stop distance
Sweep time	Units: meters or feet (Can also be set as Preferences)
Frequency mode	Bandpass, lowpass
CAT mode averaging	Set sweep time in seconds
Distance-to-fault	Available in CAT mode. Standard on N991xC analyzers. Range = velocity factor x speed of light x (# of points -1) / freq. span x 2; # of points auto coupled according to start and stop distance entered. Resolution = range / (# of points -1) Transform modes: Bandpass, low-pass Window types: Maximum, medium, and minimum Alias free range indicator: On/Off Dispersion compensation for waveguide: Yes
Return loss, log magnitude	-500 to 500 dB
Log magnitude resolution	0.01 dB
VSWR	1.01 to 1000
VSWR resolution	0.01
VNA mode	
VNA Transmission/Reflection (T/R)	S11, S21 magnitude and phase (requires option 210)
VNA S-parameters	S11, S21, S22, S12 magnitude and phase (N9912C requires option NAX, other N991xC requires options 210 and 211)
Number of traces	Four traces available: Tr1, Tr2, Tr3, Tr4
Display formats	Single-trace Dual-trace split (each trace on separate graticule) Dual-trace overlay (both traces on one graticule) Three-trace split (each trace on separate graticule) Three-trace overlay (all three traces on one graticule) Quad-trace split (each trace on separate graticule) Quad-trace overlay (all four traces on one graticule)
VNA trace formats	Log magnitude, linear magnitude, VSWR, phase, Smith chart, polar, group delay, unwrapped phase, real impedance, imaginary impedance, Z magnitude
Frequency settings	Start, stop, center, span
Frequency sweep type	Linear
Sweep type trigger	Continuous, single
Sweep trigger source	Internal, external, point (point trigger applies to 1-port cal only)
Sweep trigger slope	Positive, negative

Sweep trigger delay	0 to 10 seconds
Averaging	Sweep: 2 to 1000; Point: 2 to 500
Smoothing	Computes the moving average of adjacent data points. Smoothing aperture defines the trace width (number of points) to be averaged. Minimum aperture: 0.05% of frequency span Maximum aperture: 25% of frequency span
Scale	Autoscale, scale, reference level, reference position Autoscale: Automatically selects scale resolution and reference value to center the trace. Autoscale all: Scales all visible traces.
S11, log magnitude	-500 to 500 dB
Log magnitude resolution	0.01 dB
VSWR	1.01 to 1000
VSWR resolution	0.01
Phase	-180 to +180 degrees (unwrapped phase can show larger values)
Phase resolution	0.01 degrees
Phase offset	-360 to +360 degrees
Magnitude offset	-100 to +100 dB
Trace math	Vector division or subtraction of current linear measurement values and memory data
Port extension	For both port 1 and port 2, delay settings. Port extensions apply to all measurements.
Marker formats	Default marker format is the trace format. Other formats: R + jX; Z magnitude; Phase; Real; Imaginary Mag & Phase dB Angle
General CAT / VNA modes	
Marker functions	Peak, Next Peak, Peak Left, Peak Right, Mkr→Center, Mkr→Delay, Min Search, Peak Excursion, Peak Threshold, Target, Bandwidth (BW, Q, Loss), Tracking CAT mode only: Tracking 3 peaks (CAT mode), Marker→Start distance, Marker→Stop distance
Marker table	On/Off
Marker types	Normal, delta, data trace and memory trace markers
Marker coupling	On/Off (coupling between traces)
Frequency blanking	Security level: none, high. If high, all frequency information is blanked out. An instrument preset is required to re-enable the frequency information.
Display data	Display data, memory, data and memory, or data math
Trace math	One memory trace per data trace.

CAT and VNA mode calibrations

FieldFox analyzers offer three tiers of calibrations, thus providing users with different levels of calibration effort and accuracy.

CalReady

CalReady is the most basic calibration and is sufficient for a quick pass/fail or go/no go verification. Every FieldFox is calibrated at the factory, at test ports 1 and 2, at room temperature. CalReady can be applied either as an “enhanced response CalReady” or a “2-port CalReady.” The default setting is 2-port CalReady, so correction is applied to both ports. A user preference allows user to change the CalReady methodology to enhanced response CalReady.

A 30-minute warm-up period is recommended for a quick test. A 60-minute warm-up is necessary for more stringent test requirements.

If CalReady is the basis for most measurements, the annual cal cycle must be followed, as the CalReady calibration will be updated during the annual cal cycle.

Standard calibrations

Standard calibrations are the most accurate calibrations offered in FieldFox. FieldFox's calibration engine is based on Keysight's flagship PNA calibration engine, and as such, offers many of the standard calibrations. FieldFox supports both coaxial and waveguide calibrations. The table below lists the commonly used calibrations.

Keysight recommends a 30-minute warm-up period for standard calibrations. For ultimate in stability and accuracy, a 90-minute warm-up period is necessary.

Frequency response Open response Short response Thru response With and without isolation	Simultaneous magnitude and phase correction of frequency response errors for either reflection or transmission measurements. Isolation corrects for crosstalk errors.
1-port OSL (Port 1) 1-port OSL (Port 2)	Open, short, and load Traditional 1-port calibration for reflection measurements. Corrects for directivity, source match, and frequency response errors.
SSL (for waveguide)	For waveguide calibrations, depending on the calibration kit definition, this is presented as a short, offset short and load calibration.
Enhanced response (also known as one-path, two-port) Forward enhanced response Reverse enhanced response	Corrects for frequency response and source match. Partial correction for load match for low-loss reciprocal devices.
QSOLT (2-port)	QSOLT or Quick short-open-load-thru is FieldFox's default recommended calibration for insertable devices. Full 12-term error correction. Requires fewer connections, compared to traditional SOLT (4 compared to 7). Corrects for directivity, source match, reflection frequency response, load match, and transmission frequency response.
Full 2-port (unknown thru calibration)	FieldFox's default recommended calibration for non-insertable devices. Full 12-term error correction. Beneficial for characterizing non-insertable devices such as Type-N to 3.5 mm, or female-female devices. Corrects for directivity, source match, reflection frequency response, load match, and transmission frequency response.
TRL	TRL or thru-reflect-line compensates for directivity, reflection, and transmission frequency response in both the forward and reverse directions.

** Note: FieldFox does not offer the traditional SOLT calibration. Instead, it offers the more accurate Full 2-port (unknown thru), and also QSOLT.

ECal

FieldFox supports all Keysight USB ECal modules, both standard and value-line ECal's.

FieldFox's guided calibration wizard

FieldFox's calibration wizard recommends a calibration type and calibration kit based on selected parameters and connector types. Alternatively, users can select their own calibration type and calibration kit. FieldFox's calibration wizard ensures a valid calibration selection.

Interpolation error correction

With any type of accuracy enhancement applied, interpolated mode recalculates the error coefficients when the test frequencies are changed. The number of points can be increased or decreased, and the start/stop frequencies can be changed, but the resulting frequency span must be a subset of the original calibration frequency span.

Connectors

The FieldFox firmware supports the following connector types by default. Add other connector types with a calibration kit that contains the connector type.

Coaxial	Waveguide	
Type-N 50 ohm	WR-10	WR-90
Type-N 75 ohm	WR-15	WR-112
7/16	WR-19	WR-137
TNC	WR-22	WR-159
Type-F	WR-28	WR-187
7 mm	WR-34	WR-229
3.5 mm	WR-42	WR-284
2.92 mm	WR-51	WR-650
2.4 mm	WR-62	
1.85 mm	WR-75	

FieldFox S-parameter measurement uncertainties

The configurations listed below include measurement uncertainties based on ISO GUM methodology calculations.

FieldFox model	Calibration kit	Calibration type	DUT connector	Uncertainty
N991xC	85518A or 85519A	Full 2-port calibration	Type-N	Spec
N991xC	85054D	Full 2-port calibration	Type-N	Spec
N991xC	N7554A	Full 2-port calibration	Type-N	Spec
N991xC	N4690D	Full 2-port calibration	Type-N	Spec

Corrected Measurement Uncertainty

N9912/13/14/15C, 85518A or 85519A, Full 2-port Cal, DUT: Type-N, Spec

Corrected performance table calculated using uncertainties with a coverage factor of 2.

Corrected performance (dB)	0.003 to 500 MHz	0.5 to 2 GHz	2 to 8 GHz	8 to 10 GHz
Directivity	40	41	34	32
Source match	38	34	30	29
Load match ¹	39	36	28	28
Reflection tracking	±00011	±0.02	±0.036	±0.009
Transmission tracking ¹	±0.044	±0.087	±0.21	±0.21

Uncertainty plots: power level of -20 dBm, 10 Hz IF bandwidth, no averaging, battery saver off, and 60-minute warm-up time. Includes uncertainties due to drift, noise, compression, and dynamic accuracy. Coverage factor of 1 applied to uncertainties, for ease of comparison with other industry handheld analyzers.

Transmission uncertainty (S₂₁, S₁₂)

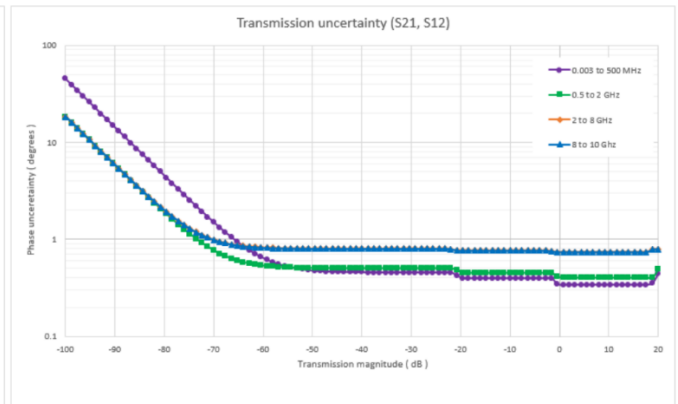
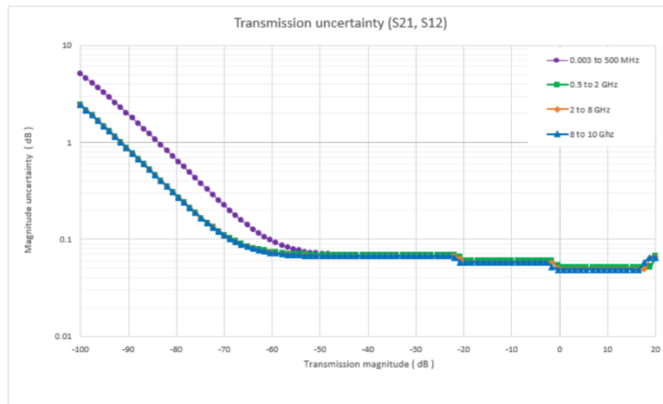

Reflection uncertainty (S₁₁, S₂₂)

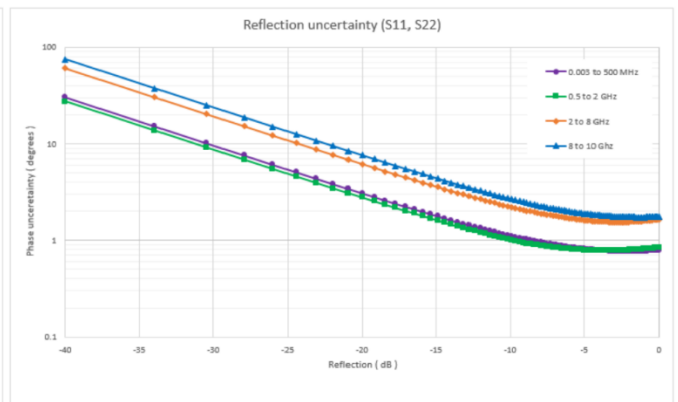
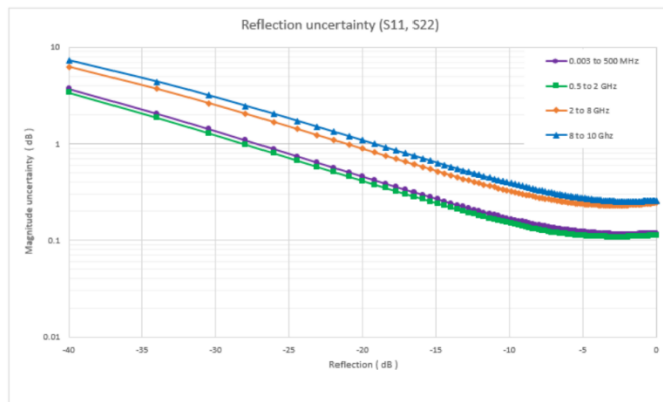

1. Load match and transmission tracking are typical values.

N9912/13/14/15C, 85054D, Full 2-port Cal, DUT: Type-N, Spec

Corrected performance table calculated using uncertainties with a coverage factor of 2.

Corrected performance (dB)	0.003 to 500 MHz	0.5 to 2 GHz	2 to 8 GHz	8 to 10 GHz
Directivity	37	37	33	31
Source match	37	37	33	31
Load match ¹	37	37	33	31
Reflection tracking	±0.00068	±0.0019	±0.0053	±0.0073
Transmission tracking ¹	±0.004	±0.012	±0.038	±0.042

Uncertainty plots: power level of -20 dBm, 10 Hz IF bandwidth, no averaging, battery saver off, and 60-minute warm-up time. Includes uncertainties due to drift, noise, compression, and dynamic accuracy. Coverage factor of 1 applied to uncertainties, for ease of comparison with other industry handheld analyzers.

Transmission uncertainty (S21, S12)

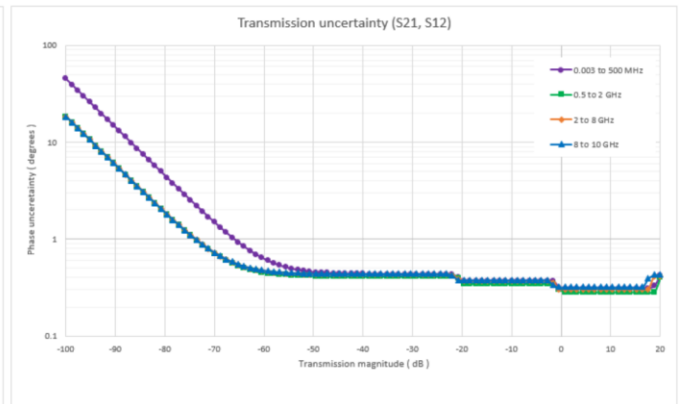
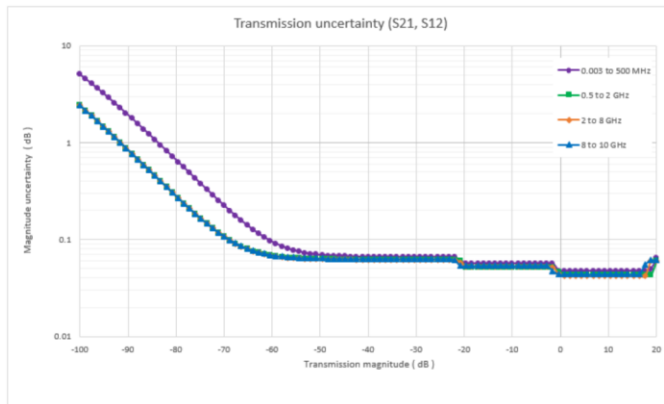

Reflection uncertainty (S11, S22)

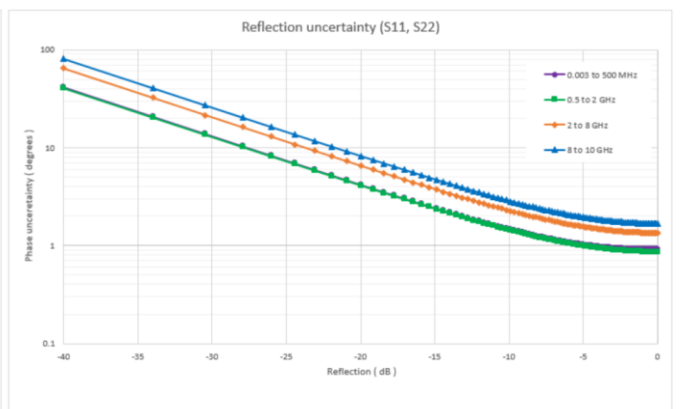

¹ Load match and transmission tracking are typical values.

N9912/13/14/15C, N7554A ECal, Full 2-port Cal, DUT: Type-N, Spec

Corrected performance table calculated using uncertainties with a coverage factor of 2.

Corrected performance (dB)	0.003 to 500 MHz	0.5 to 2 GHz	2 to 8 GHz	8 to 10 GHz
Directivity	44	44	42	40
Source match	36	32	28	28
Load match ¹	36	34	28	27
Reflection tracking	±0.0067	±0.0036	±0.054	±0.076
Transmission tracking ¹	±0.063	±0.086	±0.14	±0.16

Uncertainty plots: power level of -20 dBm, 10 Hz IF bandwidth, no averaging, battery saver off, and 60-minute warm-up time. Includes uncertainties due to drift, noise, compression, and dynamic accuracy. Coverage factor of 1 applied to uncertainties, for ease of comparison with other industry handheld analyzers.

Transmission uncertainty (S21, S12)

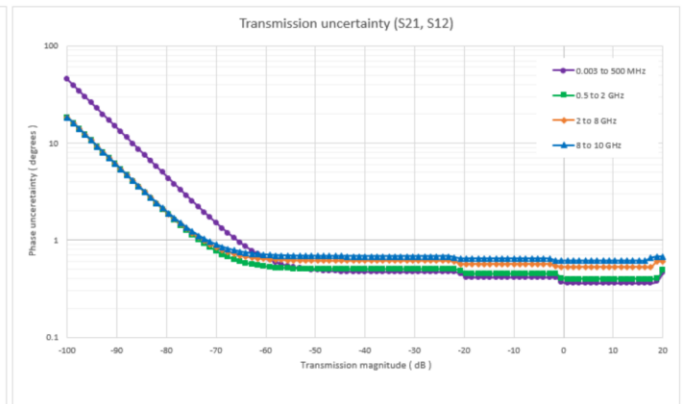
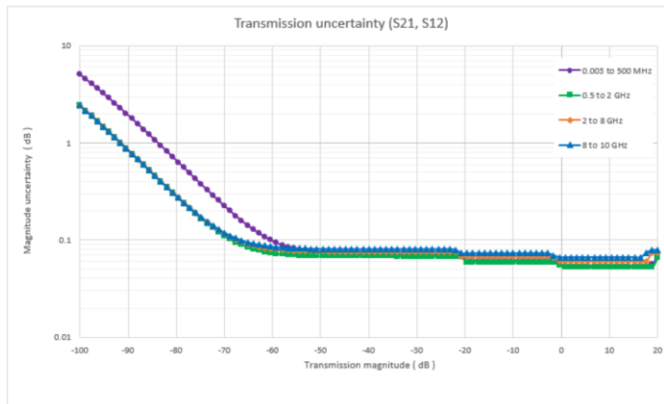

Reflection uncertainty (S11, S22)

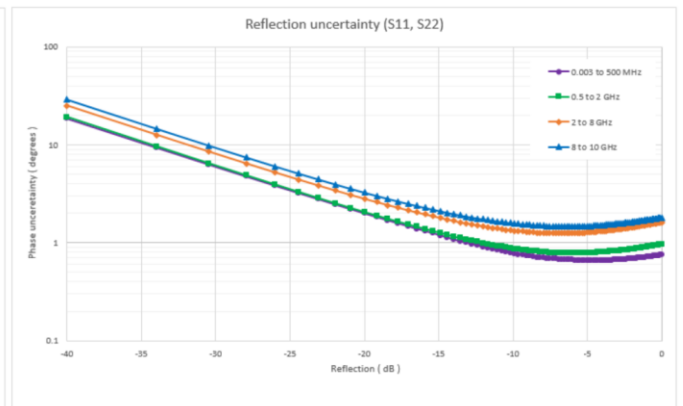
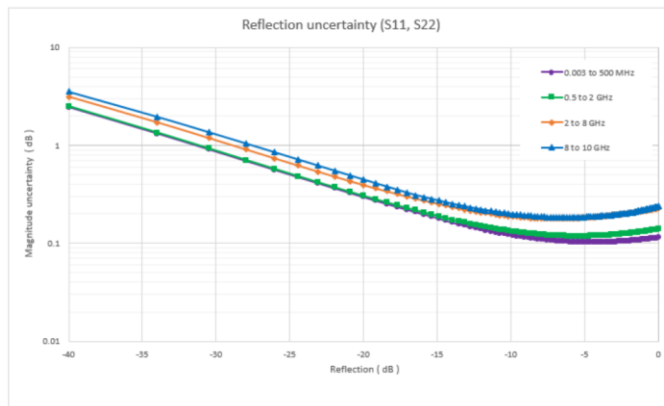

¹ Load match and transmission tracking are typical values.

N9912/13/14/15C, N4690D ECal Option 0DC, Full 2-port Cal, DUT: Type-N, Spec

Corrected performance table calculated using uncertainties with a coverage factor of 2.

Corrected performance (dB) ¹	0.003 to 500 MHz	0.5 to 2 GHz	2 to 8 GHz	8 to 10 GHz
Directivity	45	45	40	40
Source match	40	43	40	40
Load match ²	37	37	37	33
Reflection tracking	±0.05	±0.03	±0.03	±0.03
Transmission tracking ²	±0.064	±0.063	±0.063	±0.099

Uncertainty plots: power level of -20 dBm, 10 Hz IF bandwidth, no averaging, battery saver off, and 60-minute warm-up time. Includes uncertainties due to drift, noise, compression, and dynamic accuracy. Coverage factor of 1 applied to uncertainties, for ease of comparison with other industry handheld analyzers.

Transmission uncertainty (S₂₁, S₁₂)

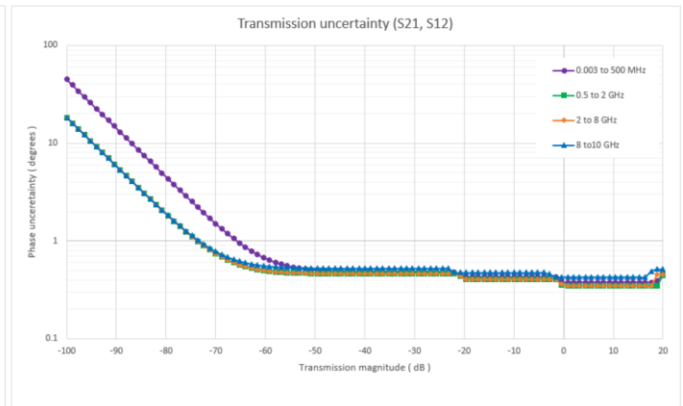
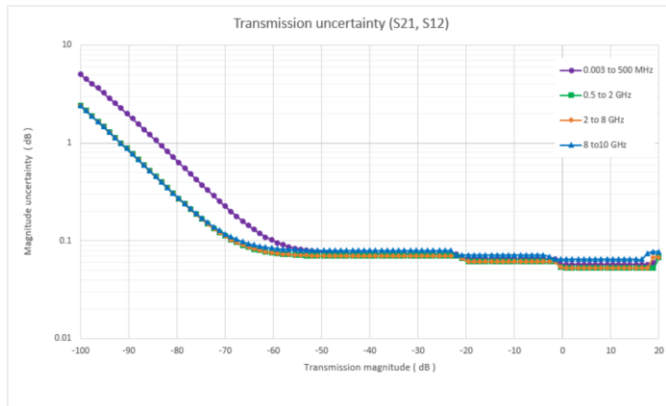

Reflection uncertainty (S₁₁, S₂₂)

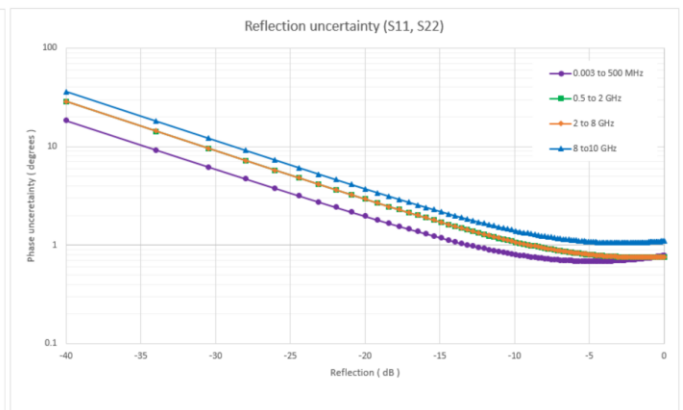
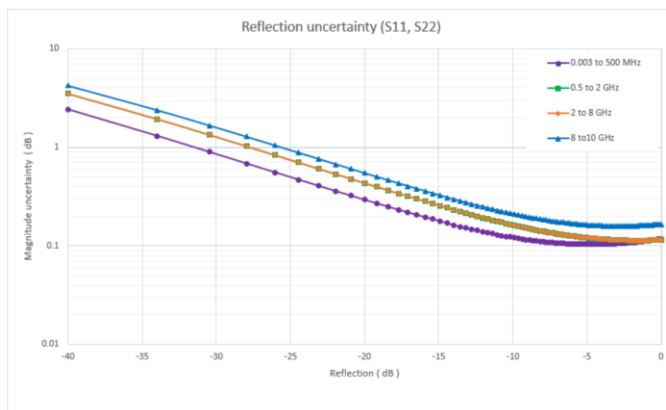

1. When applied power exceeds -5 dBm, calibration results will be degraded from the performance indicated in this table.
2. Load match and transmission tracking are typical values.

N9912/13/14/15C, N4690D ECal Option 003, Full 2-port Cal, DUT: Type-N, Spec

Corrected performance table calculated using uncertainties with a coverage factor of 2.

Corrected performance (dB) ¹	0.3 to 2 MHz	2 to 10 MHz	10 to 500 MHz	0.5 to 2 GHz	2 to 8 GHz	8 to 10 GHz
Directivity	30	40	45	45	40	40
Source match	28	35	40	43	40	40
Load match ²	28	35	40	37	37	33
Reflection tracking	±0.12	±0.07	±0.05	±0.03	±0.03	±0.03
Transmission tracking ²	±0.12	±0.07	±0.05	±0.063	±0.063	±0.098

Uncertainty plots: power level of -20 dBm, 10 Hz IF bandwidth, no averaging, battery saver off, and 60-minute warm-up time. Includes uncertainties due to drift, noise, compression, and dynamic accuracy. Coverage factor of 1 applied to uncertainties, for ease of comparison with other industry handheld analyzers.

Transmission uncertainty (S21, S12)

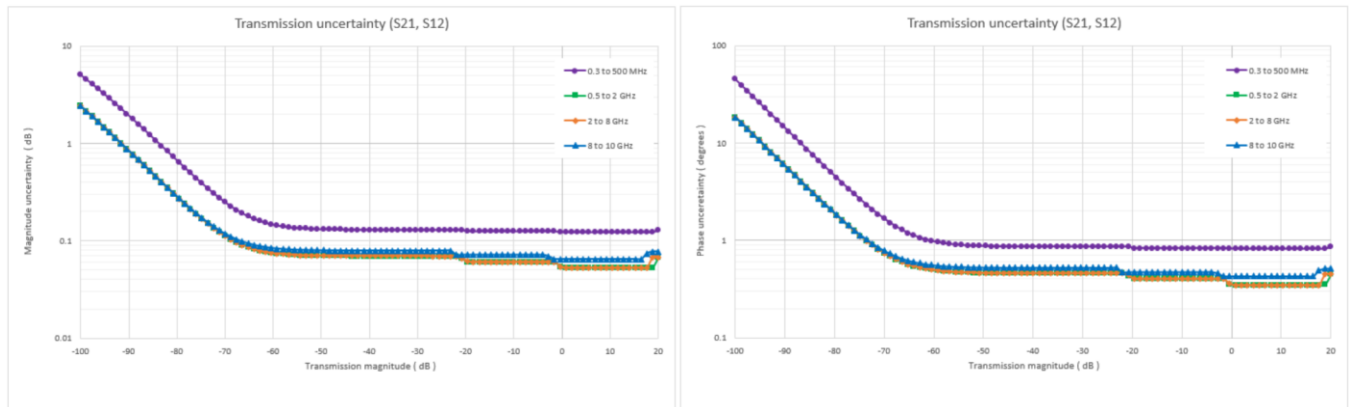

Reflection uncertainty (S11, S22)

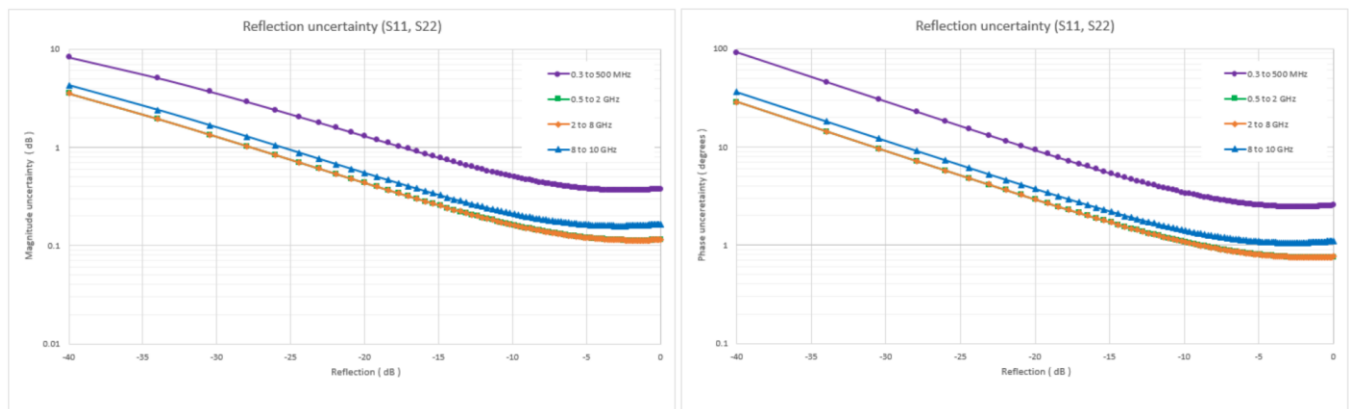

1. When applied power exceeds -5 dBm, calibration results will be degraded from the performance indicated in this table.
2. Load match and transmission tracking are typical values.

TDR Cable Measurements (Option 215)

The performance listed in TDR cable measurements, VNA time domain, mixed-mode S-parameters and vector voltmeter sections applies to the capabilities available in the following models:

Description	Model number
FieldFox RF & microwave (combination) analyzers	N9912C, N9913C, N9914C, N9915C

See [FieldFox Configuration Guide](#) for option information. Many capabilities listed in this Data Sheet require options.

The TDR cable option adds time domain reflectometry (TDR) measurements to FieldFox's CAT mode. FieldFox's TDR measurements are based on an inverse Fourier transform of the frequency-domain data. TDR measurements are useful in not only identifying the location of faults along cables, but also the nature of the fault. Resistive, inductive and capacitive faults will each have a different response. These differences help engineers and technicians' trouble-shoot line faults.

Measurements: TDR (linear rho), TDR (ohm), TDR & DTF

Y-axis: linear (rho) or impedance (ohm)

X-axis: distance (meters or feet)

VNA Time Domain (Option 010)

In time-domain mode, FieldFox computes the inverse Fourier transform of the frequency-domain data to display reflection or transmission coefficients versus time.

Setup parameters

Time	Start, stop, center, span
Gating	Start, stop, center, span, and on/off
Numbers of points, velocity vector, line loss, window shape, independent control for all four traces	

Time stimulus modes

Low-pass step	Low-pass step is similar to a traditional time domain reflectometer (TDR) stimulus waveform. It is used to measure low-pass devices. The frequency-domain data should extend from DC (extrapolated value) to a higher value.
Low-pass impulse	Low-pass impulse response is used to measure low-pass devices.
Bandpass impulse	The bandpass impulse simulates a pulsed RF signal and is used to measure the time domain response of band-limited devices.

Windows

The windowing function can be used to filter the frequency domain data and thereby reduce overshoot and ringing in the time domain response.

Windows	Minimum, medium and maximum, manual entry of Kaiser Beta and impulse width.
---------	---

Gating

The gating function can be used to selectively remove reflection or transmission time domain responses. In converting back to the frequency domain, the effects of the responses outside the gate are removed. The results can be viewed with gating on and off, using two traces.

Gate types	Notch, bandpass
Gate shapes	Maximum, wide, normal, minimum

Mixed-Mode S-Parameters (Option 212)

Mixed-mode S-parameters are also known as balanced measurements. Not available for N9912C.

Measurements

Scc11	Common mode reflection
Sdd11	Differential mode reflection
Scd11	Differential mode stimulus, common mode response
Sdc11	Common mode stimulus, differential mode response

FieldFox's mixed-mode S-parameter measurements require the use of the default factory calibration or a user 2-port calibration. So, the FieldFox analyzer must be equipped with 2-port measurement functionality to measure mixed-mode S-parameters. Mixed-mode S-parameters are an extension of the VNA capabilities.

Vector Voltmeter (VVM) (Option 308)

With vector voltmeter mode, you can characterize the difference between two measurements easily. The zeroing function allows you to create a reference signal and characterize the difference between two device measurements. The results are shown on a large display in digital format.

Model	Options	Frequency range
N9912C	NA4 and 308	3 kHz to 4 GHz
	NA6 and 308	3 kHz to 6.5 GHz
	NAX and 308	3 kHz to 10 GHz
N9913C	308	3 kHz to 4 GHz
N9914C	308	3 kHz to 6.5 GHz
N9915C	308	3 kHz to 10 GHz

Setup parameters

1-port cable trimming	Reflection (S11 or S22 measurement), magnitude and phase
2-port transmission	Transmission or S21 measurement, magnitude, and phase
A/B and B/A	Ratio of two receivers or channels, magnitude, and phase – Need an external signal generator for the A/B or B/A measurement
	Frequency (one CW frequency point)
	IF bandwidth: 10 Hz to 100 kHz or 3 Hz to 30 kHz
	Output power: Low, high, manual

Ratio accuracy (A/B and B/A)

Must zero before measuring DUT. Recommend using a high-quality power splitter or 6 dB attenuators to minimize uncertainty due to mismatch.

	Frequency	Nominal (dB)
N991xC	100 kHz to 2 GHz	± 0.2

Spectrum Analyzer (Option SAx on N9912C or Option 233 on Combination Analyzers)

The performance listed in this section applies to the spectrum analyzer capabilities available in the following models:

Description	Model number
FieldFox RF combination analyzers	N9912C, N9913C, N9914C, N9915C
FieldFox RF spectrum analyzers	N9933C, N9934C, N9935C

See [FieldFox Configuration Guide](#) for option information. Many capabilities listed in this Data Sheet require options.

Frequency and time specifications

Model	Option	Frequency range ¹
N9912C	SA4	3 kHz to 4 GHz
	SA6	3 kHz to 6.5 GHz
	SAX	3 kHz to 10 GHz
N9913C	233	3 kHz to 4 GHz
N9914C	233	3 kHz to 6.5 GHz
N9915C	233	3 kHz to 10 GHz
N9933C		3 kHz to 4 GHz
N9934C		3 kHz to 6.5 GHz
N9935C		3 kHz to 10 GHz

Frequency reference, -10 to 55 °C

Accuracy	±0.9 ppm (spec) + aging ±0.5 ppm (typical) + aging
Accuracy, when locked to GPS	±0.01 ppm (spec) ²
Accuracy, when GPS antenna is disconnected	±0.4 ppm (nominal) ³
Aging rate	±1 ppm/yr for 20 years (spec), will not exceed ±3.5 ppm

Frequency readout accuracy (start, stop, center, marker)

± (readout frequency x frequency reference accuracy + RBW centering + 0.5 x horizontal resolution)	Horizontal resolution = frequency span / (trace points – 1) RBW centering: 5% x RBW, FFT mode (nominal) 16% x RBW, step mode (nominal)
--	---

¹ The spectrum analyzer is tunable to 0 Hz or DC.

² This is a pass-through specification provided by the GPS vendor and is not verified by Keysight.

³ The maximum drift expected in the frequency reference applicable when the ambient temperature changes ± 5°C from the temperature when the GPS signal was last connected.

Marker frequency counter

Accuracy	\pm (marker frequency x frequency reference accuracy + counter resolution)
Resolution	0.1, 1, 10 Hz
Frequency span	Spec
Range	0 Hz (zero span), 10 Hz to maximum frequency range of instrument
Resolution	1 Hz
Accuracy	\pm (2 x RBW centering + horizontal resolution) for detector = Normal
Sweep time readout	Measured value of the time required to complete a sweep from start to finish, including time to tune receiver, acquire data, and process trace.
Trace update	Nominal
Span = 20 MHz, RBW, VBW = 3 kHz	9 updates per second
Span = 100 MHz, RBW, VBW autocoupled	25 updates per second
Span = 10 GHz, RBW = 1 MHz, VBW autocoupled	Approximately 2 updates per second
Center frequency tune and transfer¹	Nominal
101 points, zero span	80 ms
101 points, 1 MHz span	75 ms
101 points, 100 MHz span	75 ms
Sweep time, zero span	Nominal
Range	1 μ s to 6000 s
Resolution	100 ns
Readout	Entered value representing trace horizontal scale range
Trigger (for zero span and FFT sweeps)	
Trigger type	Free run, external, video, RF burst, periodic
Trigger slope	Positive edge, negative edge
Trigger delay	Range: -150 ms to 10 s Resolution: 100 s
Auto trigger	Forces a periodic acquisition in the absence of a trigger event Range: 0 (off) to 30 s
Trigger position (zero span)	Controls horizontal position of the pulse edge; use sweep time to zoom into pulse edge Range: 0 to 10, integer steps; 0 is left edge of graticule, 10 is right edge of graticule

¹ Within full frequency range of instrument, not band dependent.

RF burst trigger	Nominal
Dynamic range	40 dB
Bandwidth	20 MHz
Operating frequency range	20 MHz to maximum instrument frequency
Sweep (trace) point range	
All spans	101, 201, 401, 601, 801, 1001 (defaults to 401) Arbitrary 2 to 20,001 settable through soft key "# Points" or SCPI

Resolution bandwidth (RBW)	Nominal	
Range (-3 dB bandwidth)		
Zero span	10 Hz to 5 MHz	1, 3, 10 sequence
Non-zero span	1 Hz to 5 MHz (>5MHz) ²	1, 1.5, 2, 3, 5, 7.5, 10 sequence < 300 kHz, 300 kHz, 1 MHz, 3 MHz, 5 MHz (Other RBWs may be set depending on settings)
		Step keys change RBW in 1, 3, 10 sequence
Selectivity (-60 dB / -3 dB)	4:1	

Bandwidth accuracy	Nominal	
Zero span	10 Hz to 1 MHz	± 5%
	3 MHz	± 10%
	5 MHz	± 15%
Non-zero span	1 Hz to 100 kHz	± 1%
	300 kHz to 1 MHz	± 5%
	3 MHz	± 10%
	5 MHz	± 15%

Video bandwidth (VBW)		
	1 Hz to 5 MHz	1, 1.5, 2, 3, 5, 7.5, 10 sequence

Amplitude accuracy and range specifications

Amplitude range	Average CW power	
Measurement range	DANL to +20 dBm	
Input attenuator range	0 to 40 dB, in 5 dB steps	
Preamplifier	Nominal	
Frequency range	Full band (3 kHz to maximum frequency of instrument)	
Gain	+20 dB, 3 kHz to 10 GHz	
Maximum safe input level	Average CW power	DC
	+25 dBm, 0.3 watts	±40 VDC
Display range		
Log scale	10 divisions 0.01 to 100 dB/division in 0.01 dB steps	
Linear scale	10 divisions	
Scale units	dBm, dBmV, dBμV, dBmA, dBμA, W, V, A, dBμV/m, dBμA/m, dBG, dBT	

50 MHz absolute amplitude accuracy (dB)

10 dB attenuation, input signal -40 to -5 dBm, peak detector, preamplifier off¹, 300 Hz RBW, all settings auto-coupled. No warm-up required.

	Spec (-10 to 55 °C)	Typical (-10 to 55 °C)
N991xC/N993xC	±0.60	±0.20

Total absolute amplitude accuracy (dB) with preamp off

10 dB attenuation, input signal -15 to -5 dBm, peak detector, 300 Hz RBW, all settings auto-coupled, includes frequency response uncertainties. No warm-up required.

	Frequency	Spec (-10 to 55 °C)	Typical (-10 to 55 °C)
N991xC/N993xC with preamplifier off	3 kHz to 100 kHz	±1.00	±0.20
	≥ 100 kHz to 15 MHz	±0.80	±0.15
	≥ 15 MHz to 500 MHz	±0.80	±0.15
	≥ 500 MHz to 4.5 GHz	±1.00	±0.15
	≥ 4.5 GHz to 10 GHz	±1.00	±0.20

Total absolute amplitude accuracy (dB) with preamp on (Option 235 required and turned on)

20 dB attenuation, input signal -25 to -15 dBm, peak detector, 300 Hz RBW, all settings auto-coupled, includes frequency response uncertainties. No warm-up required.

	Frequency	Spec (-10 to 55 °C)	Typical (-10 to 55 °C)
N991xC/N993xC with preamplifier on	3 kHz to 100 kHz	±1.20	±0.25
	≥ 100 kHz to 15 MHz	±0.80	±0.25
	≥ 15 MHz to 500 MHz	±0.80	±0.15
	≥ 500 MHz to 4.5 GHz	±1.00	±0.15
	≥ 4.5 GHz to 10 GHz	±1.00	±0.15

¹ The spec and typical values, with preamp on, are identical to that with preamp off, but the input signal levels are -40 to -20 dBm.

Resolution bandwidth switching uncertainty	Nominal
RBW < 5 MHz	0.0 dB
For signals not at center frequency	0.7 dB peak-to-peak
RF input VSWR	Nominal
1 MHz to 2.7 GHz	1.9 :1
> 2.7 GHz to 7.5 GHz	1.8 :1
> 7.5 GHz to 10 GHz	1.9 :1
Reference level	
Range	-210 to +90 dBm
Traces	
Detectors	Normal, positive peak, negative peak, sample, average (RMS)
States	Clear/write, max hold, min hold, average, view, blank
	Number of averages: 1 to 10,001
Number	4: all four can be active simultaneously and in different states
Markers	
Number of markers	6
Type	Normal, delta, marker table
Marker functions	Noise, band power, frequency counter
Audio beep	Volume and tone change with signal strength
Marker table	Display 6 markers
Marker→	Peak, next peak, peak left, peak right, center frequency, reference level, minimum
	Tune frequency, for AM/FM tune and listen
Marker properties	Peak criteria: peak excursion, peak threshold
	Delta reference fixed: Off or On
	Time zero fixed: Off or On

Dynamic range specifications

Displayed average noise level (DANL) - (dBm)

Input terminated, RMS detection, log averaging, 0 dB input attenuation, reference level of -20 dBm, normalized to 1 Hz RBW, measured at non-zero frequency span

	Preamp Off		Preamp On	
	Spec (-10 to 55 °C)	Typical (-10 to 55 °C)	Spec (-10 to 55 °C)	Typical (-10 to 55 °C)
3 kHz to 100 kHz	-121	-134	-142	-156
≥ 100 kHz to 1 MHz	-121	-134	-148	-157
≥ 1 MHz to 15 MHz	-134	-141	-157	-162
≥ 15 MHz to 2.6 GHz	-139	-148	-158	-165
≥ 2.6 GHz to 4.5 GHz	-140	-147	-157	-163
≥ 4.5 GHz to 7.5 GHz	-138	-145	-156	-162
≥ 7.5 GHz to 10 GHz	-134	-143	-152	-160

Residual responses (dBm)

Nominal

Input terminated preamp off, 0 dB attenuation

9 kHz to 10 MHz	-93
≥ 10 MHz to 10 GHz ¹	-105

Input related responses (dBc)

Tuned frequency (f)	Excitation frequency	Spur frequency	Nominal
-30 dBm signal at mixer input			
f < 2.6 GHz, f ≥ 7.5 GHz to 10 GHz	f + 2 * 3.56625GHz, f + 3.56625GHz/2	f	-80
f ≥ 2.6 GHz to 7.5 GHz	f + 2 * 9.3375GHz, f + 9.3375GHz/2	f	-80
fOffset = frequency offset of excitation frequency from tuned frequency (f)			
f < 2.6 GHz, f ≥ 7.5 GHz to 10 GHz	f + fOffset	f - n * fOffset, (n=1,2, 3,...)	-75
	f + fOffset	f - 2 * (5.625MHz ± fOffset)	-70
f ≥ 2.6 GHz to 7.5 GHz	f + fOffset	f - n * fOffset, (n=1, 2, 3,...)	-75
	f + fOffset	f - 2 * (5.625MHz ± fOffset)	-70

Other spurious responses (dBc)

Nominal

LO related spurs	
3 kHz to 10 GHz	-75
Sideband	-80
Battery charging sideband	-70

¹ Excludes 3.3114375 GHz at -98 dBm.

1 dB gain compression point (P1dB) ¹ - (dBm)		Nominal
N991xC, N993xC	10 MHz to 100 MHz	0
	≥ 100 MHz to 500 MHz	+2
	≥ 500 MHz to 8 GHz	+4
	≥ 8 GHz to 10 GHz	+7.5

Second harmonic distortion		Nominal	
-30 dBm signal at mixer input	SHI (dBm)	Distortion (dBc)	
N991xC, N993xC	10 to 50 MHz	+45	-75
	≥ 50 MHz to 1.3 GHz	+50	-80
	≥ 1.3 to 3.75 GHz	+30	-60
	≥ 3.75 to 5 GHz	+50	-80

Third order intermodulation distortion (TOI)		Typical (dBm)
Two -15 dBm signals, 100 kHz spacing at mixer input (-10 to 55 °C)		
N991xC, N993xC	50 MHz to 500 MHz	+6.5 (+8 @ room temperature)
	≥ 500 MHz to 2.6 GHz	+10
	≥ 2.6 GHz to 7.5 GHz	+8.5
	≥ 7.5 GHz to 10 GHz	+10.5

Spur free dynamic range (dB) at 2.4 GHz 2/3 (TOI – DANL)		Nominal
N991xC, N993xC		>104

¹ Tested with two-tone signals: the first tone signal at –30 dBm mixer input and the second tone with 40 MHz spacing from the first tone at mixer input. Step up the power of the second tone until 1 dB compression has been achieved. 0 dB attenuation, span of 5 kHz, and 30 Hz RBW.

Distortion and noise limited (10 Hz RBW) dynamic range (nominal)

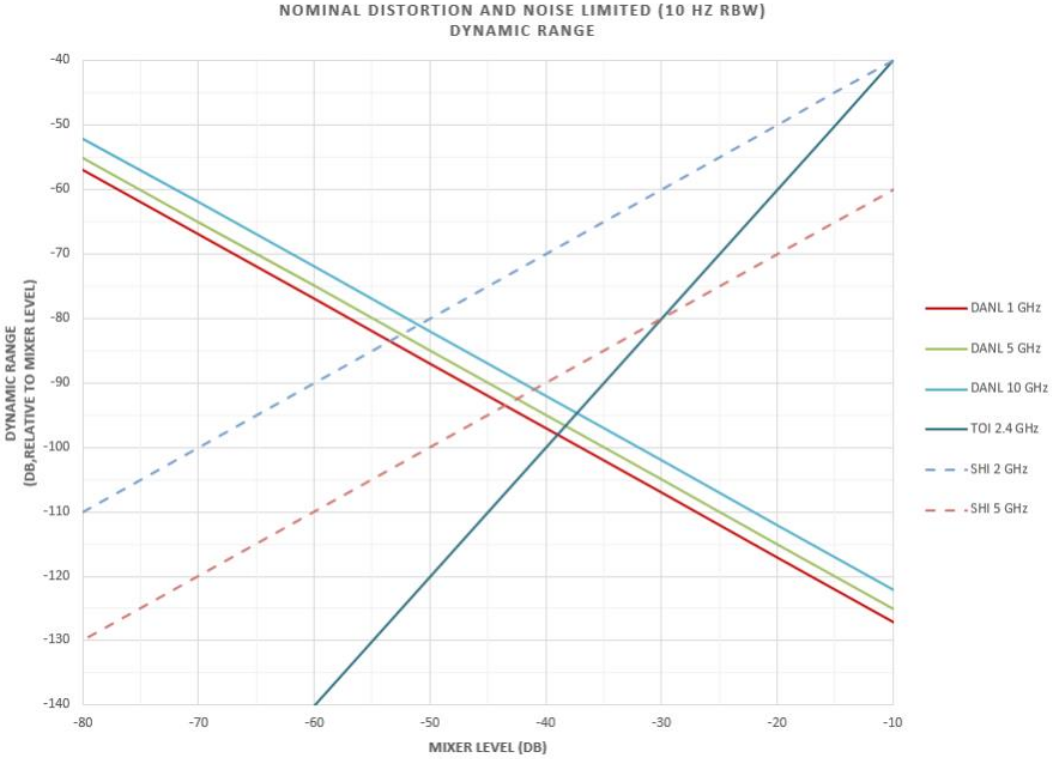

SSB phase noise at 1 GHz center frequency

Phase noise (dBc/Hz)

SSB phase noise at 1 GHz

Offset	Spec (-10 to 55 °C)	Typical (-10 to 55 °C)
10 kHz	-107	-112
30 kHz	-109	-113
100 kHz	-105	-110
1 MHz	-119	-124
3 MHz ¹	-123	-129
5 MHz	-124	-129

Phase noise at different center frequencies (nominal)

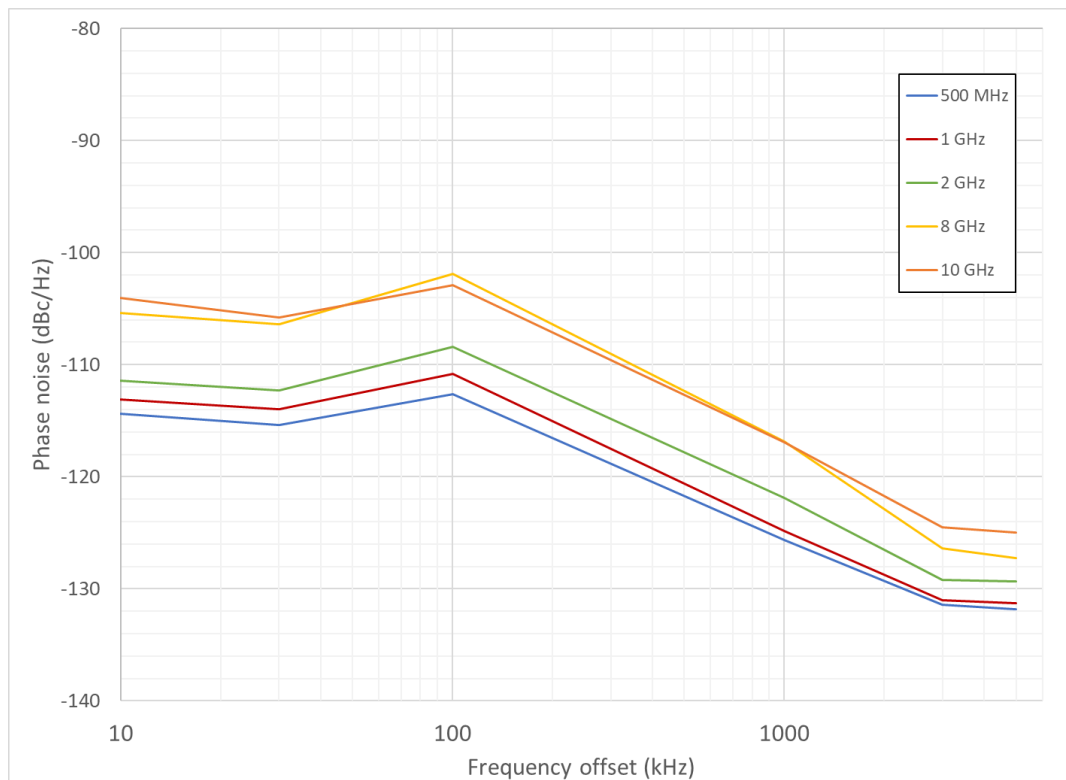

¹ Tested at 2.99 MHz.

Dynamic range versus offset frequency versus RBW (nominal)¹

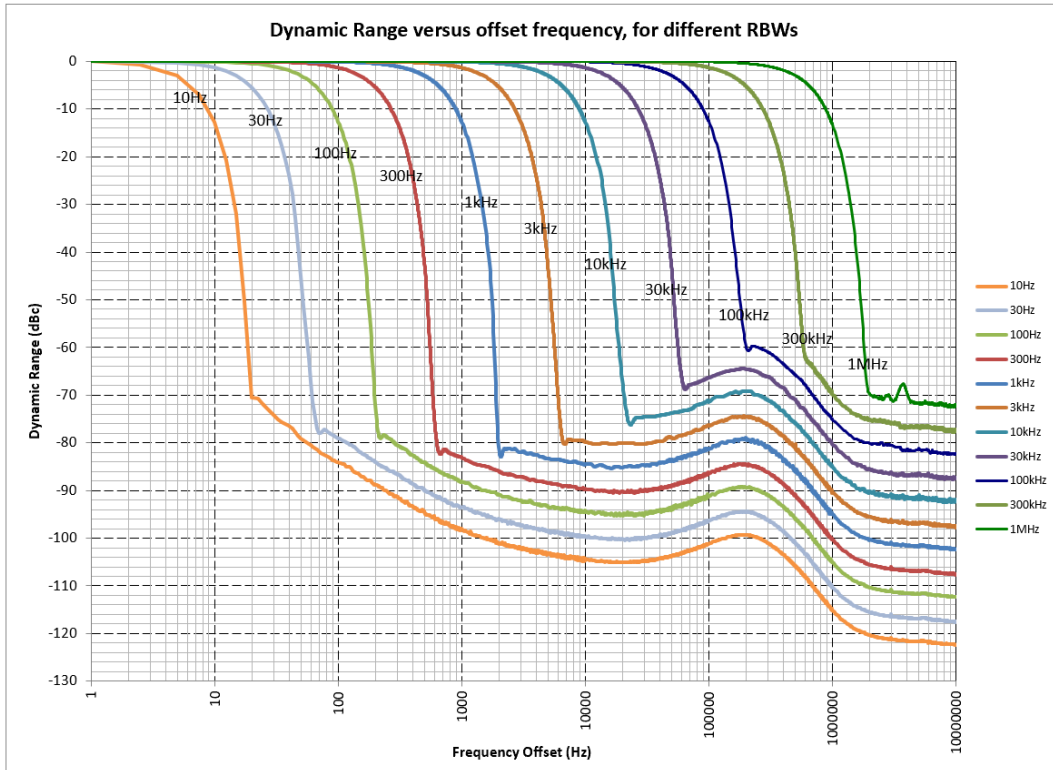

¹ For 1 MHz RBW, the sideband observed may degrade the dynamic range to -68 dBc

Baseband mode

The performance listed in this section applies to the signal path of “Baseband” for the spectrum/signal analyzer. Switch to the “Baseband” mode to optimize the analyzer’s performance if the input signal is below 6.5 MHz. Preamp is not applicable to the baseband signal path.

Frequency range for Baseband	Specifications
N991xC/N993xC	3 kHz to 6.5 MHz

Frequency span for Baseband	Specifications
Range	0 Hz (zero span), 10 Hz to maximum frequency range for baseband (6.5 MHz)

Resolution Bandwidth (RBW) for Baseband		
Range (-3 dB bandwidth)		Nominal
Zero span	10 Hz to 5 MHz	1, 3, 10 sequence
Non-zero span	1 Hz to 5 MHz	1, 1.5, 2, 3, 5, 7.5, 10 sequence for RBW < 300 kHz, 300 kHz, 1 MHz, 3 MHz, 5 MHz (Other RBWs may be set depending on settings)
		Step keys change RBW in 1, 3, 10 sequence

Amplitude range for baseband		
	Specs	
Measurement range	DANL to +20 dBm	
Input attenuator range	0 to 40 dB, in 5 dB steps	

Max safe input level for baseband		
	Average CW power	DC
	+25 dBm, 0.3 Watt	±40 VDC

Total absolute amplitude accuracy for baseband (dB)		
10 dB attenuation, input signal –12 dBm, peak detector, preamplifier off, 30 Hz RBW, all settings auto-coupled, includes frequency response uncertainties. No warm-up required.		
	Frequency range	Nominal
N991xC/N993xC	3 kHz to 100 kHz	± 1
	≥ 100 kHz to 500 kHz	± 0.6
	≥ 500 kHz to 6.5 MHz	± 0.9

Input VSWR for baseband	Nominal
20 kHz to 6.5 MHz	1.6 :1

Displayed Average Noise Level (DANL) for baseband (dBm)

Input terminated, RMS detection, log averaging, 0 dB input attenuation, reference level of -20 dBm, normalized to 1 Hz RBW, measured at non-zero frequency span.

Frequency range	Typical (-10 to 55 °C)
3 kHz to 20 kHz	-150
≥ 20 kHz to 100 kHz	-160
≥ 100 kHz to 2 MHz	-160
≥ 2 MHz to 6.5 MHz	-161

1 dB gain compression point (P1dB)1 for baseband (dBm)

Nominal

25 kHz to 5 MHz	-6.5
≥ 5 MHz to 6.5 MHz	-7

Second harmonic distortion for baseband

Nominal

-30 dBm signal at mixer input

Frequency	SHI (dBm)	Distortion (dBc)
3 kHz to 1 MHz	+35	-65
> 1 MHz to 3.25 MHz	+30	-60

Third order intermodulation distortion (TOI) for baseband (dBc)

Nominal

Two -28 dBm tones at input mixer, spaced by 100 kHz, 0 dB input attenuation

	Frequency	TOI
N991xC, N993xC	275 kHz to 6.5 MHz	-76

Residual responses for baseband (dBm)

Input terminated preamp off, 0 dB attenuation

Frequency

Nominal

N991xC/N993xC	3 kHz to 6.5 MHz	-130
---------------	------------------	------

Phase noise for baseband (dBc/Hz) SSB phase noise at 5 MHz center frequency

Offset	Nominal
10 kHz	-130
30 kHz	-133
100 kHz	-135
≥ 400 kHz	-136

Tracking Generator or Independent Source

The performance listed in this section applies to the tracking generator and independent source capabilities available in the following models:

Description	Model number
FieldFox RF (combination) analyzers	N9912C, N9913C, N9914C, N9915C
FieldFox RF spectrum analyzers	N9933C, N9934C, N9935C

See [FieldFox Configuration Guide](#) for option information. Many capabilities listed in this Data Sheet require options.

Note: Traditional tracking generators track the receiver frequency only. In FieldFox analyzers, the tracking generator frequency can be set to either track the receiver frequency, or act as an independent CW source.

Model	Options	Tracking generator or independent source frequency range
N9912C	SA4 w/ 220	3 kHz to 4 GHz
	SA6 w/ 220	3 kHz to 6.5 GHz
	SAX w/ 220	3 kHz to 10 GHz
N9913C	233 w/ 220	3 kHz to 4 GHz
N9914C	233 w/ 220	3 kHz to 6.5 GHz
N9915C	233 w/220	3 kHz to 10 GHz
N9933C	220	3 kHz to 4 GHz
N9934C	220	3 kHz to 6.5 GHz
N9935C	220	3 kHz to 10 GHz
Power step size		
		Power settable in 1 dB steps across power range
Functions		
Mode	Continuous wave (CW), CW coupled, tracking (swept frequency)	
Operations	Normalization, frequency offset, spectral reversal	

Tracking Generator or Independent Source

Output power (max)	Frequency	Typical	
N991xC, N993xC	300 kHz to 10 GHz	+10 dBm	
Power level accuracy ¹		Nominal	
		Port 1 at -20 dBm	
N991xC, N993xC	300 kHz to 10 GHz	± 0.5 dB	

Dynamic range (dB)	Frequency	Typical (-10 to 55 °C)		Nominal
		Preamp off	Preamp on	
N991xC, N993xC	300 kHz to 2 MHz	89	107	
	≥ 2 MHz to 2.6 GHz	99	115	
	≥ 2.6 to 7 GHz	98	113	
	≥ 7 to 7.5 GHz	97	113	
	≥ 7.5 to 10 GHz	95	110	

¹ N991xC power levels are calibrated based on PNA-X's tuned receiver, which means primarily the fundamental is included (for frequencies ≥ 10 MHz). For frequencies < 10 MHz, power levels are calibrated in the factory using a broadband power sensor.

Real-Time Spectrum Analyzer (RTSA) (Option 350)

The performance listed in this section applies to the real-time spectrum analyzer capabilities available in the following models:

Description	Model number
FieldFox RF (combination) analyzers	N9912C, N9913C, N9914C, N9915C
FieldFox RF spectrum analyzers	N9933C, N9934C, N9935C

See [FieldFox Configuration Guide](#) for option information. Many capabilities listed in this Data Sheet require options.

Model	Options	Real-time analysis frequency range ¹
N9912C	SA4 w/ 350	3 kHz to 4 GHz
	SA6 w/ 350	3 kHz to 6.5 GHz
	SAX w/ 350	3 kHz to 10 GHz
N9913C	233 w/ 350	3 kHz to 4 GHz
N9914C	233 w/ 350	3 kHz to 6.5 GHz
N9915C	233 w/350	3 kHz to 10 GHz
N9933C	350	3 kHz to 4 GHz
N9934C	350	3 kHz to 6.5 GHz
N9935C	350	3 kHz to 10 GHz

Real-time analysis

Measurements	Density Spectrum, Spectrogram, Real-time Spectrum		
Maximum real-time bandwidth	10 MHz (Standard)	40 MHz (Opt B04)	120 MHz (Opt B10) ²
Resolution bandwidth (Span dependent, $20 \leq \text{Span}/\text{RBW} \leq 280$)	1 Hz to 500 kHz	1 Hz to 2 MHz	1 Hz to 5 MHz
Minimum signal duration with 100% probability of intercept (POI) at full amplitude accuracy	9.13 μ s	6.13 μ s	5.52 μ s
Minimum detectable signal ³	11 ns	11 ns	47 ns
Min. acquisition time (Density Spectrum)	20 ms	20 ms	20 ms
Min. acquisition time (Spectrogram)	500 μ s/div	500 μ s/div	500 μ s/div
Max. acquisition time (Density Spectrum)	540 ms	337 ms	336 ms
Max. acquisition time (Spectrogram)	10 s/div	10 s/div	10 s/div
Spurious-free dynamic range	69 dB	65 dB	62 dB
IF flatness	0.1 dB (typical)	0.1 dB (typical)	0.1 dB (typical)
FFT rate	190,000 FFT/s	190,000 FFT/s	190,000 FFT/s
Number of display points	821	821	821

¹ Performance specified above 1 MHz. Usable down to 3 kHz.

² Option B10 is not available for the N9912C.

³ Minimum detectable pulse width is the shortest pulse width of a pulsed CW signal that will display a peak amplitude that is no worse than 60 dB below the peak amplitude of a CW signal of the same power level for a defined span and auto-coupled RBW.

RTSA (Option 350)

Traces	
Number of traces	4: all four can be active simultaneously and in different states
Detectors	Normal, positive peak, negative peak, sample, average (RMS)
States	Clear/write, max. hold, min. hold, average, view, blank
Markers	
Number of markers	6
Type	Normal, delta, peak
Marker →	Peak, next peak, center frequency, reference level
Trigger	
Trigger type	Free run, external, video, RF burst, periodic

I/Q Analyzer (IQA) (Option 351)

The specifications in this section apply to the I/Q analyzer capabilities available in the following models:

Description	Model number
FieldFox RF (combination) analyzers	N9913C, N9914C, N9915C (N9912C excluded)
FieldFox RF spectrum analyzers	N9933C, N9934C, N9935C

See [FieldFox Configuration Guide](#) for option information. Many capabilities listed in this Data Sheet require options.

	Model	I/Q analyzer frequency range ¹
N991xC and N993xC	N9913C, N9933C	1 MHz to 4 GHz
	N9914C, N9934C	1 MHz to 6.5 GHz
	N9915C, N9935C	1 MHz to 10 GHz

Measurements	
Spectrum (frequency domain)	Magnitude spectrum
Waveform (time domain)	RF envelope I/Q waveform (Dual simultaneous top and bottom windows: I vs. time and Q vs. time)

Display (multi-domain) user defined	
Set up and display up to 4 simultaneous and multi-domain measurements with any combination of the following:	
Frequency domain: Magnitude spectrum	
Time domain: RF envelope, Q vs. I (polar plot), Phase vs. time, Unwrapped phase vs. time, I vs. time, Q vs. time	
Time summary table showing I/Q capture settings: I/Q capture time, waveform start/stop, Spectrum FFT time	

¹ Performance specified above 1 MHz. Usable down to 3 kHz.

Measurement setup

I/Q capture parameters	Capture time, sample rate, sample period, capture samples		
I/Q streaming (requires Option 353, not for N9912C)	Provides continuous streaming of IQ data up to 1.25 M Sample data/sec (or maximum BW of 1 MHz) over the Ethernet port in either VITA49A or Decodio formats		
Bandwidth options	10 MHz (Standard)	40 MHz (Opt B04)	120 MHz (Opt B10)¹
Frequency span	10 Hz to 10 MHz	10 Hz to 40 MHz	10 Hz to 120 MHz
IF frequency responses			
Bandwidth options	10 MHz (Standard)	40 MHz (Opt B04)	120 MHz (Opt B10)¹
	Typical (-10 to 55 °C)	Typical (-10 to 55 °C)	Typical (-10 to 55 °C)
IF flatness			
Magnitude	±0.06 dB	±0.07 dB	±0.18 dB
Phase deviation from linearity ²	0.39° peak-to-peak 0.14° rms	1.3° peak-to-peak 0.6° rms	7.6° peak-to-peak 3° rms
Group delay flatness (peak-to-peak) ¹	1.19 ns	0.9 ns	2 ns
EVM accuracy			
Bandwidth options	10 MHz (Standard)	40 MHz (Opt B04)	120 MHz (Opt B10)¹
N991xC, N993xC	Nominal	Nominal³	Nominal³
EVM (at center frequency 1 GHz)			
5G NR 64 QAM	—	—	1.00%
LTE-A FDD TM3.1 (10 MHz)	0.50%	0.50%	0.50%
LTE-A FDD TM3.1 (20 MHz)	—	0.50%	0.50%
WCDMA TM4 (5 MHz)	0.60%	0.60%	0.60%
EVM (at center frequency 2.1 GHz)			
LTE-A FDD TM3.1 (10 MHz)	0.60%	0.60%	0.60%
LTE-A FDD TM3.1 (20 MHz)	—	0.65%	0.65%
WCDMA TM4 (5 MHz)	0.84%	0.84%	0.84%
EVM (at center frequency 3.5 GHz)			
5G NR 64 QAM	—	—	1.00%
LTE-A FDD TM3.1 (20 MHz)	—	0.95%	0.95%
EVM (at center frequency 5.8 GHz)			
5G NR 64 QAM	—	—	1.10%
Data acquisition			
Total capture memory	1024 MB		
Length single I/Q capture	8 bytes/sample		
Maximum length I/Q capture	128 MSa		
Sample rate (I/Q pairs)	1.25 x span		
ADC resolution	14 bits		

¹ Not available for the N9912C

² Not guaranteed below 50 MHz.

³ Applies when fast channel equalization (default) is OFF...

Maximum I/Q capture time

120 MHz span	0.89 s
100 MHz span	1 s
40 MHz span	2.6 s
10 MHz span	10.7 s
1 MHz span	107 s
100 kHz span	1073 s
10 kHz span	10737 s

Dynamic range specifications (wideband path)

Displayed average noise level (DANL) (dBm)

Input terminated, RMS detection, log averaging, 0 dB input attenuation, reference level of -20 dBm, normalized to 1 Hz RBW, measured at non-zero frequency span

N991xC (N9912C excluded), N993xC	Preamp OFF	Preamp ON
	Typical (-10 to 55 °C)	(-10 to 55 °C)
3 kHz to 1 MHz	-133	-157
≥ 1 MHz to 120 MHz	-148	-166
≥ 120 MHz to 2.6 GHz	-151	-166
≥ 2.6 GHz to 7.5 GHz	-150	-165
≥ 7.5 GHz to 10 GHz	-146	-161

Input related responses (dBc)

Nominal

Tuned frequency (f)	Excitation frequency	Spur frequency	Nominal
-30 dBm signal at mixer input			
f ≥ 3 kHz to 2.6 GHz, f ≥ 7.5 GHz to 10 GHz	f + 2 * 3.375 GHz, f + 3.375 GHz/2	f	-75
f ≥ 2.6 GHz to 7.5 GHz	f + 2 * 10.125 GHz, f + 10.125 GHz/2	f	-75
f < 2.6 GHz, f > 7.5 GHz to 10 GHz	f + fOffset	f - fOffset	-70
	f + fOffset	f - 2 * (37.5 MHz - fOffset)	-65
	f + fOffset	f + 2 * (112.5 MHz + fOffset)	-60
	f + fOffset, (fOffset > 0)	f - 6 * (37.5 MHz - fOffset)	-75
	f + fOffset, (fOffset > 0)	f - 6 * (112.5 MHz + fOffset)	-75
f > 2.6 GHz to 7.5 GHz	f + fOffset	f - fOffset	-70
	f + fOffset	f + 2 * (37.5 MHz - fOffset)	-65
	f + fOffset	f - 2 * (112.5 MHz + fOffset)	-65
	f + fOffset, (fOffset > 0)	f + 6 * (37.5 MHz - fOffset)	-75
	f + fOffset, (fOffset > 0)	f + 6 * (112.5 MHz + fOffset)	-75

Dynamic range specifications (wideband path)

Spur-free dynamic range (dB) at 2.4 GHz 2/3 (TOI - DANL)		Nominal
		> 105
Third order intermodulation distortion (TOI) (dBm)		Typical
Two -20 dBm signals, 100 kHz spacing at mixer input (-10 to 55 °C)		
N991xC and N993xC	50 MHz to 500 MHz	+7.0
	≥ 500 MHz to 2.6 GHz	+8.0
	≥ 2.6 GHz to 7.5 GHz	+6.5
	≥ 7.5 GHz to 10 GHz	+10.5
Traces		
Number of windows & layout	1, 2 (top & bottom), 3 (one top, two bottom), or 4 (quad display)	
Number of traces	4, all four traces can be active simultaneously in all windows	
States	Clear/write, max hold, min hold, average, view, blank	
Markers		
Number of markers	6 normal + delta pairs	
Type	Normal, delta, peak, marker table (up to 6 markers)	
Couple markers	On/off (couple markers between traces in different windows)	
Marker →	Peak, next peak, center frequency, reference level	
Trigger		
Trigger type	Free run, external, video, RF burst	
Trigger slope	Positive edge, negative edge	
Trigger delay	Range: -150 ms to 500 ms	
	Resolution: 100 ns	
Auto trigger	Forces a periodic acquisition in the absence of a trigger event	
	Range: 0 (off) to 30 s	
Data storage		
Data types	Trace, Trace+state, picture (PNG)	
I/Q capture data file types	CSV, text (TXT), SDF (compatible with 89600 VSA software), Matlab (MAT)	
I/Q data formats via SCPI	Raw binary interleaved I/Q data recording, REAL32 (ASCII is default)	

Noise Figure (NF) (Option 356)

The specifications in this section apply to the noise figure measurement capabilities available in the following models:

Description	Model number
FieldFox RF (combination) analyzers	N9913C, N9914C, N9915C
FieldFox RF spectrum analyzers	N9933C, N9934C, N9935C

See [FieldFox Configuration Guide](#) for option information. Many capabilities listed in this Data Sheet require options.

No warm-up is required for the instrument specifications.

	Models	Noise figure analysis frequency range
N991xC, N993xC	N9913C, N9933C	10 MHz to 4 GHz
	N9914C, N9934C	10 MHz to 6.5 GHz
	N9915C, N9935C	10 MHz to 10 GHz

Measurements	
Noise figure	Noise figure (F dB)
Noise factor	Noise figure as a ratio (F)
Gain	Gain (G dB)
Noise temperature	Noise temperature in Kelvin (K)
Y-factor	Y-factor (Y dB)

Setup parameters		Supplemental information	
Noise source		Load ENR value(s)	
DUT type	Amplifier, Downconverter, Upconverter, Multi-stage Converter	Built-in GUI wizard aids DUT measurement setup	
Integration	Mode	Auto	Auto Integration: optimizes gain to avoid compression, and measurement time to achieve jitter goal
		Fixed	Fixed Integration: the time per point over which the measurement is averaged is fixed
	Jitter goal	Sets measurement jitter performance target	
	Max time / point	Allows user to trade-off jitter vs. measurement time	
	Jitter warning	On: displays circles on trace data if jitter goal is exceeded Off (default): disables trace circle indicators	
Loss compensation	Before DUT, After DUT	User definable, compensates measurement for loss (dB) before and after DUT	

Measurement bandwidth (nominal)	
Range	5 MHz (default), 2 MHz, 1 MHz, 300 kHz

NF

Frequency reference

Noise figure uncertainty calculator			Supplemental information
			Refer to spectrum analyzer specifications
DUT			Built-in
			Based on data from measurement
DUT	Mode	Spot	Applies single values uniformly across frequency: Input $ \Gamma $ and Output $ \Gamma $ Γ specification style: Maximum, 95th percentile, 80th percentile, Median, Mean, Fixed Γ distribution: Rayleigh, Fixed, Uniform in Circle
		Table	Applies a table of values vs. frequency: Input $ \Gamma $ and Output $ \Gamma $ Γ specification style: Maximum, 95th percentile, 80th percentile, Median, Mean, Fixed Γ distribution: Rayleigh, Fixed, Uniform in Circle
Preamplifier	Mode	Spot	Applies single values uniformly across frequency Input $ \Gamma $ and Output $ \Gamma $ Γ specification style: Maximum, 95th percentile, 80th percentile, Median, Mean, Fixed Γ distribution: Rayleigh, Fixed, Uniform in Circle
		Table	Applies a table of values vs. frequency: Input $ \Gamma $ and Output $ \Gamma $ Γ specification style: Maximum, 95th percentile, 80th percentile, Median, Mean, Fixed Γ distribution: Rayleigh, Fixed, Uniform in Circle
Noise figure uncertainty calculator			Supplemental information
			Built-in
			Based on data from measurement
Noise source	ENR Mode	Spot	Applies single values uniformly across frequency: ENR (dB), ENR Uncertainty (dB), On $ \Gamma $, Off $ \Gamma $, ENR Uncertainty Confidence (SD) Γ specification style: Maximum, 95th percentile, 80th percentile, Median, Mean, Fixed Γ distribution: Rayleigh, Fixed, Uniform in Circle
		Table	Applies a table of values vs. frequency: ENR (dB), ENR Uncertainty (dB), On $ \Gamma $, Off $ \Gamma $, ENR Uncertainty Confidence (SD) Γ specification style: Maximum, 95th percentile, 80th percentile, Median, Mean, Fixed Γ distribution: Rayleigh, Fixed, Uniform in Circle
		Smart (Auto)	For U183x USB smart noise sources (SNS) only. When connected with a USB SNS, FieldFox automatically downloads the ENR table data from the SNS and applies a table of values vs. frequency: ENR (dB), ENR Uncertainty (dB), On $ \Gamma $, Off $ \Gamma $, ENR Uncertainty Confidence (SD) Γ specification style: Maximum, 95th percentile, 80th percentile, Median, Mean, Fixed Γ distribution: Rayleigh, Fixed, Uniform in Circle
Uncertainty contributions	Jitter		Random independent events (fluctuations) within the bandwidth occurring during the noise measurement
	ENR		Excess noise ratio of the hot noise source connected to the DUT during the measurement
	Mismatch		Errors resulting from reflections due to impedance differences between components

Noise figure uncertainty calculator		Supplemental information
	User calibration	Errors due to the optional user calibration which is performed with a defined noise standard (ENR source) connected to the input of an LNA, and fixturing/cables used in the DUT measurement, and port 2 of the FieldFox
Uncertainty coverage		User settable, uncertainty coverage can be set to 1σ (80%), 2σ (95% default), 3σ (99.5%)
Uncertainty bars		Displays vertical bars representing the calculated measurement uncertainty overlaid on the trace data
Loss compensation	Before DUT	User definable, single value, compensates measurement for insertion loss (dB) before DUT
	After DUT	User definable, single value, compensates measurement for loss (dB) after DUT
Instrument match		VSWR values are preloaded and automatically applied for instrument and U7227A/C/F or U7228A/C/F preamplifiers
Calibration options		
Receiver calibration		Uses noise source to calibrate FieldFox receiver gain bandwidth
User calibration with external U7227A/C/F or U7228A/C/F preamplifier		Optional calibration performs hot/cold measurement with external preamplifier; applies receiver and user calibrations

Noise figure¹

		Internal preamplifier ON (dB)	Internal preamplifier ON + U7227/8A (dB)	Internal preamplifier ON + U7227/8C (dB)
N991xC, N993xC	Frequency	(dB)	(dB)	(dB)
	10 to 15 MHz	16.5	6.7	—
	≥ 15 MHz to 100 MHz	12.5	6.0	—
	≥ 100 MHz to 2.6 GHz	12.5	5.4	6.4
	≥ 2.6 to 4 GHz	13.5	5.4	6.5
	≥ 4 to 4.5 GHz	13.5	—	5.5
	≥ 4.5 to 6 GHz	14.5	—	5.6
	≥ 6 to 7.5 GHz	14.5	—	4.7
≥ 7.5 to 10 GHz	17.5	—	5.3	

		Internal preamplifier ON (dB)	Internal preamplifier ON + U7227/8F ² (dB)
N991xC, N993xC	Frequency	(dB)	(dB)
	≥ 2.1 to 2.6 GHz	12.5	10.1
	≥ 2.6 to 4 GHz	13.5	10.2
	≥ 4 to 4.5 GHz	13.5	8.3
	≥ 4.5 to 6 GHz	14.5	8.3
	≥ 6 to 7.5 GHz	14.5	8.3
≥ 7.5 to 10 GHz	17.5	8.6	

External preamplifier specifications

	U7227/8A	U7227/8C	U7227/8F
Frequency	10 MHz to 4 GHz	100 MHz to 26.5 GHz	2 to 50 GHz
Noise figure (dB)	10 MHz to 100 MHz: < 5.5	100 MHz to 4 GHz: < 6	2 to 4 GHz: < 10
	100 MHz to 4 GHz: < 5	4 to 6 GHz: < 5	4 to 40 GHz: < 8
		6 to 18 GHz: < 4	40 to 44 GHz: < 9
		18 to 26.5 GHz: < 5	44 to 50 GHz: < 10
Gain (dB)	10 to 100 MHz: > 16	100 MHz to 26.5 GHz:	2 GHz to 50 GHz:
	100 MHz to 4 GHz: > 0.5F ³ + 17	> 16.1 + 0.26F	> 16.5 + 0.23F
RF connector	3.5 mm (m)	3.5 mm (m)	2.4 mm (m)

Noise source

Model	Frequency range	ENR
346A	10 MHz to 18 GHz	5 to 7 dB
346B	10 MHz to 18 GHz	14 to 16 dB
U1832A	10 MHz to 18 GHz	4.5 to 6.5 dB
U1833A	10 MHz to 18 GHz	14 to 16 dB

¹ Noise figure (NF) = DANL - (-173.98 - 2.51) dB

Nominal calculation is based on spectrum analyzer (SA) displayed average noise level (DANL) specification (dBm) stated as input terminated, RMS detection, log averaging, 0 dB input attenuation, reference level of -20 dBm, normalized to 1 Hz RBW.

Noise figure (NF) = D - (K - L), where D is the DANL (displayed average noise level) specification, K is kTB (-173.98 dBm in a 1 Hz bandwidth at 290 K), and L is 2.51 dB (the effect of log averaging used in DANL verifications).

² U7227/8F maximum frequency is 50 GHz; can be used with N991xC/3xC up to maximum frequency of 10 GHz.

³ F signifies frequency in GHz.

Noise source setup		Supplemental info
ENR mode	Spot	Single ENR value (not frequency dependent) (default: 15 dB)
	Table	Applies table of ENR values vs. frequency, Create, save, recall, edit ENR tables File type: .ENR
	Smart (Auto)	For U183x USB SNS only. When connected with a USB SNS, FieldFox updates the T cold value at beginning of every sweep, and automatically loads the ENR file from the USB SNS
T cold	Auto (default) or Manual	Noise temperature of cold noise standard connected to DUT during the measurement
Connector type	SMB (m)	DC bias requires accessory N9910X-713 BNC to SMB cable, for 346 noise sources only
	USB 3.0 (Type C)	For U183x USB SNS only
Control voltage drive level	28 ± 1 V	For 346 noise sources only, no need for U183x USB SNS
Operating temperature	0 to 55 °C	
Sweep		
Number of points	11 (default), 21, 51, 101, 201, 401, 601, 801, 1001	
Sweep mode	Continuous or single	
DUT profiles available (built-in GUI wizard aids DUT measurement setup)		
Amplifier	Includes any non-frequency-converting device	
Downconverter	Frequency context can be set to RF or IF; sideband can be set to LSB, USB, DSB	
Upconverter	Frequency context can be set to RF or IF; sideband can be set to LSB, USB, DSB	
Multi-stage converter	Frequency context can be set to RF or IF	
Display formats		
Number of traces	Two traces available	
Display formats	Single-trace	
	Dual-trace overlay (both traces on one graticule)	
	Dual-trace split (each trace on separate top and bottom graticules)	
Display data	Display data, memory, data and memory	
Trace memory	One memory trace per data trace, total of 2 memory traces	
Limit lines	Upper and lower for each trace	
Markers		
Number of markers	6	
Type	Normal, Delta, Marker Table	
Marker table	Display 6 markers	
Marker to →	Peak, Next Peak, Peak Left, Peak Right, Center Frequency, Reference Level, Minimum, Target	
Data storage		
Data types	Trace, Trace+State, Picture (PNG), CSV	

The performance listed in these sections below applies to the spectrum analyzer IF output, preamplifier, interference analyzer and spectrogram, channel scanner and 89600 VSA software capabilities available in the following models:

Description	Model number
FieldFox RF (combination) analyzers	N9912C, N9913C, N9914C, N9915C
FieldFox RF spectrum analyzers	N9933C, N9934C, N9935C

See [FieldFox Configuration Guide](#) for option information. Many capabilities listed in this Data Sheet require options.

Spectrum Analyzer IF Output

Sweep

Number of points	11 (default), 21, 51, 101, 201, 401, 601, 801, 1001
Sweep mode	Continuous or single

Spectrum analyzer mode, zero span, IF output settings¹

Bandwidth options	10 MHz (Standard)	40 MHz (Opt B04)	120 MHz (Opt B10) ²
IF output mode (Narrow)			
Center frequency	33.75 MHz	33.75 MHz	33.75 MHz
IF bandwidth	10 MHz	10 MHz	10 MHz
IF output mode (Wide)			
Center frequency	—	100 MHz	100 MHz
Conversion gain³			
	Center frequency	Narrowband path	Wideband path
N991xC, N993xC	< 120 MHz	9 dB to -1 dB	7 dB to 4 dB
	≥ 120 MHz to 2.6 GHz	9 dB to 2 dB	14 dB to 8 dB
	≥ 2.6 GHz to 7.5 GHz	9 dB to 2 dB	15 dB to 8 dB
	≥ 7.5 GHz to 10 GHz	5 dB to -1 dB	10 dB to 4 dB
Connector	SMB male		

Preamplifier (Option 235)

	Nominal
Frequency range	Full band (3 kHz to maximum frequency of instrument)
Gain	+20 dB, 3 kHz to 10 GHz

¹ Measurements are uncalibrated in IF output mode.

² Not available on N9912C

³ RF input to SA output with -20 dBm input power, 0 dB attenuation, and preamp off.

Interference Analyzer and Spectrogram (Option 236)

	Description
Spectrogram display	Overlay, full screen, top, or bottom with active trace
Waterfall angle	Moderate, steep, gradual, wide angle
Markers	Time, delta time
Trace playback and recording	<ul style="list-style-type: none">• Record all spectrum analyzer measurements• Playback recorded data using FieldFox• Frequency mask trigger allows recording to occur upon trigger• Store data internally or USB or SD card

Channel Scanner (Option 312)

	Description
Scan mode	Range or custom list
Display type	Bar chart vertical, bar chart horizontal, channel power, strip chart, chart overlay, scan & listen
Data logging mode	Time with geo tagging
Trace playback and recording	<ul style="list-style-type: none">• Record channel power measurement• Playback recorded data using FieldFox• Store data internally or USB or SD card in .csv or .kml format• Data in .kml format can be exported to Google Earth

89600 VSA Software

EVM accuracy

Bandwidth options	10 MHz (Standard) Nominal	40 MHz (Opt B04) Nominal ²	120 MHz (Opt B10) ¹ Nominal
5G NR 64 QAM			1.00%
LTE-A FDD TM3.1 (10 MHz)	0.50%	0.50%	0.50%
LTE-A FDD TM3.1 (20 MHz)	—	0.50%	0.50%
WCDMA TM4 (5 MHz)	0.84%	0.60%	0.60%
EVM (at center frequency 2.1 GHz)			
LTE-A FDD TM3.1 (10 MHz)	0.60%	0.60%	0.60%
LTE-A FDD TM3.1 (20 MHz)	—	0.65%	0.65%
WCDMA TM4 (5 MHz)	0.84%	0.84%	0.84%
EVM (at center frequency 3.5 GHz)			
5G NR 64 QAM	—	—	1.00%
LTE-A FDD TM3.1 (20 MHz)	—	0.95%	0.95%
EVM (at center frequency 5.8 GHz)			
5G NR 64 QAM	—	—	1.10%

¹ Not available for the N9912C

² Applies when fast channel equalization (default) is OFF.

Over-the-Air (OTA) LTE FDD/TDD (Option 370/371)

The performance listed in this section applies to the OTA analyzer capabilities available in the following models:

Description	Model number
FieldFox RF (combination) analyzers	N9912C, N9913C, N9914C, N9915C
FieldFox RF spectrum analyzers	N9933C, N9934C, N9935C

See [FieldFox Configuration Guide](#) for option information. Many capabilities listed in this Data Sheet require options.

Models	Options	OTA analysis frequency range ¹
N9912C	SA4 and 370/371	1 MHz to 4 GHz
	SA6 and 370/371	1 MHz to 6.5 GHz
	SAX and 370/371	1 MHz to 10 GHz
N9913C	233 and 370/371	1 MHz to 4 GHz
N9914C	233 and 370/371	1 MHz to 6.5 GHz
N9915C	233 and 370/371	1 MHz to 10 GHz
N9933C	370/371	1 MHz to 4 GHz
N9934C	370/371	1 MHz to 6.5 GHz
N9935C	370/371	1 MHz to 10 GHz

LTE FDD/TDD Over-the-Air (OTA) measurements²

Cell scan results	Frequency PCI (Physical Cell Identifier) (C/S/G) RSRP (Reference Signal Received Power) (dBm) RSRQ (Reference Signal Received Quality) (dB) RSSI (Reference Signal Strength Indicator) (dBm) PSS (Primary Synchronization Signal) (dBm) SSS (Secondary Synchronization Signal) (dBm) SINR (Signal to Interference & Noise Ratio) (dB) Freq Err (Frequency Error) (Hz)
-------------------	---

¹ Performance specified above 1 MHz. Usable down to 3 kHz.

² For center frequency signals above 1 GHz, the built-in GPS receiver (Option 307) is highly recommended or locking to any 10 MHz frequency reference. When locked to GPS as the frequency reference, this provides accuracy of ± 0.01 ppm (spec).

OTA LTE FDD/TDD (Option 370/371)

LTE FDD/TDD Over-the-Air (OTA) measurements¹

Data formats	User can set up and display 1, 2, 3 or 4 simultaneous measurements of key performance indicators (KPI's) for any component carrier (CC0 through CC4), up to 5 carriers, in any combination of the following:
Table	Cell scan numeric results (for up to 6 cell sites (ID's) including PCI (C/S/G), RSRP, RSRQ, RSSI, PSS, SSS, SINR, Freq Err)
Bar chart	Vertical power bar graph of selectable cell scan results for up to 6 cell sites with adjustable color "heat" amplitude scale
Spectrum	Magnitude spectrum frequency domain (fixed span)
Strip chart	Magnitude of selectable cell scan results graphed over time
Signal bandwidth	Up to 20 MHz

Setup parameters

Component carrier	CC0 to CC4
Channel table	Sets frequency based on band and channel
Favorites list	Save up to 6 favorite cellular bands/channels
Window configuration	Any combination of 1, 2, 3, or all 4 windows can be displayed simultaneously: 1, 2 (top & bottom), 3 (one top, two bottom), or 4 (quad display)

Trigger

Trigger type	Free run, external
--------------	--------------------

Record / Playback

Data logging	Record, recall and playback data for all component carrier(s)
Record settings	Meas Interval, Interval type (time or distance), time interval, distance interval
Supported file types	CSV, KML
Saving data	Save/recall recorded data logs to/from internal memory or external USB or SD card

¹ For center frequency signals above 1 GHz, the built-in GPS receiver (Option 307) is highly recommended or locking to any 10 MHz frequency reference. When locked to GPS as the frequency reference, this provides accuracy of ± 0.01 ppm (spec).

Over-the-Air (OTA) 5G NR (Option 378)

The performance listed in this section applies to the OTA 5G NR analyzer capabilities available in the following models:

Description	Model number
FieldFox RF (combination) analyzers	N9912C, N9913C, N9914C, N9915C
FieldFox RF spectrum analyzers	N9933C, N9934C, N9935C

See [FieldFox Configuration Guide](#) for option information. Many capabilities listed in this Data Sheet require options.

Model	Options	OTA analysis frequency range ¹
N9912C	SA4 and 378	1 MHz to 4 GHz
	SA6 and 378	1 MHz to 6.5 GHz
	SAX and 378	1 MHz to 10 GHz
N9913C	233 and 378	1 MHz to 4 GHz
N9914C	233 and 378	1 MHz to 6.5 GHz
N9915C	233 and 378	1 MHz to 10 GHz
N9933C	378	1 MHz to 4 GHz
N9934C	378	1 MHz to 6.5 GHz
N9935C	378	1 MHz to 10 GHz

¹ Performance specified above 1 MHz. Usable down to 3 kHz.

OTA 5G NR

5G NR measurements¹

5G NR Over-the-Air (OTA)

Cell scan results	Frequency PCI (Physical Cell Identifier) (C-S-G) (Cell ID-Sector ID-Group ID) SSB Index (Synchronization Signal Block Index) SS-RSRP (Synchronization Signal Reference Signal Received Power) (dBm) SS-RSRQ (Synchronization Signal Reference Signal Received Quality) (dB) RSSI (Received Signal Strength Indicator) (dBm) SS-SINR (Synchronization Signal Signal-to-Noise and Interference Ratio) (dB) PSS (Primary Synchronization Signal) (dBm) SSS (Secondary Synchronization Signal) (dBm) PBCH DMRS (Physical Broadcast Channel Demodulation Reference Signal) (dBm) Freq Err (Frequency Error) (Hz)
-------------------	---

5G NR EVM conducted

Cell scan results	Frequency PCI (Physical Cell Identifier) SSB Numerology (Synchronization Signal Block Numerology) SSB Case (Synchronization Signal Block Case) SSB Lmax (Maximum Number SSB's within SSB Set, Lmax = 4, 8 or 64) SSB Periodicity (ms) SSB RB Offset (Synchronization Signal Block Resource Block Offset) SSB SC Offset (Synchronization Signal Block Subcarrier Offset) SSB Delta Center (Synchronization Signal Block Delta Center) (kHz) ² Sync Corr (Synchronization Correlation) (%) Channel Power (dBm) Freq Err (Frequency Error) (Hz) Time Offset (ms) PSS EVM (Primary Synchronization Signal EVM) (%rms) SSS EVM (Secondary Synchronization Signal EVM) (%rms) PBCH EVM (Physical Broadcast Channel EVM) (%rms) PBCH DMRS EVM (Physical Broadcast Channel Demodulation Reference Signal EVM) (%rms) Composite EVM (%rms) SS-RSRP (Synchronization Signal Reference Signal Received Power) (dBm) SS-RSRQ (Synchronization Signal Reference Signal Received Quality) (dB) RSSI (Reference Signal Strength Indicator) (dBm) PSS Power (Primary Synchronization Signal Power) (dBm) SSS Power (Secondary Synchronization Signal Power) (dBm) PBCH Power (Physical Broadcast Channel Power) (dBm) PCBCH DMRS Power (Physical Broadcast Channel Demodulation Reference Signal Power) (dBm)
-------------------	--

¹ For center frequency signals above 1 GHz, the built-in GPS receiver (Option 307) is highly recommended or locking to any 10 MHz frequency reference. When locked to GPS as the frequency reference, this provides accuracy of ± 0.01 ppm (spec).

² Synchronization Signal Block Subcarrier Offset is the offset of the Synchronization Signal Block from the center of the channel.

5G NR measurements¹

Signal bandwidth	Up to 100 MHz (Requires Option B10)
Component carrier	CC0 to CC7 (5G NR over-the-air (OTA) measurements) CC0 to CC4 (5G NR conducted EVM measurements)
Data formats	User can set up and display 1, 2, 3 or 4 simultaneous measurements of key performance indicators (KPI's) for any component carrier, in any combination of the following ¹ :
Table	Cell scan numeric results (for up to 6 cell sites (ID's))
Bar chart	Vertical power bar graph of selectable cell scan results for up to 6 cell sites with adjustable color "heat" amplitude scale
Spectrum	Magnitude spectrum frequency domain (fixed span)
Strip chart	Magnitude of selectable cell scan results graphed over time
Window configuration	Any combination of 1, 2, 3, or all 4 windows can be displayed simultaneously: 1, 2 (top & bottom), 3 (one top, two bottom), or 4 (quad display)

Setup parameters

Frequency error threshold	0 Hz to 7.5 kHz ²
Subcarrier spacing	15 kHz, 30 kHz, 120 kHz, 240 kHz
SSB case	Auto, A, B, C, D, E
Lmax	Auto, 4, 8, 64
Capture length	4, 8, 16, 24, 32 or 40 frames
Drive speed	Low, medium, high
SS Meas DMRS	Off, On
Phase compensation	Off, On
EMF measurement	Off, On
EMF units	dB μ V/m, V/m
Cell ID	Auto, Manual
Bandwidth	FR1: 5, 10, 15, 20, 25, 30, 40, 50, 60, 70, 80, 90, 100 MHz FR2: 50, 100 MHz
Subcarrier spacing	15 kHz, 30 kHz, 120 kHz, 240 kHz
Export results	Exports SSB center frequency, SSB subcarrier spacing, SSB Case and SSB Lmax to 5G NR OTA setup

Trigger

Trigger type	Free run, external, periodic trigger
--------------	--------------------------------------

Record / Playback

Data logging	Record, recall and playback data for all component carrier(s)
Record settings	Meas Interval, Interval type (time or distance), time interval, distance interval
Supported file types	CSV, KML
Saving data	Save/recall recorded data logs to/from internal memory or external USB or SD card

¹ You can also display the results from multiple component carriers on the table, bar chart, and strip chart displays.

² The frequency error threshold is dependent on the SCS - freq err threshold = +/- 1/4 * SCS (e.g. for 15 kHz, freq err threshold = 3.75 kHz).

Indoor and Outdoor Mapping (Option 352)

The performance listed in this section applies to the indoor and outdoor mapping capabilities available in the following models:

Description	Model number
FieldFox RF (combination) analyzers	N9912C, N9913C, N9914C, N9915C
FieldFox RF spectrum analyzers	N9933C, N9934C, N9935C

See [FieldFox Configuration Guide](#) for option information. Many capabilities listed in this Data Sheet require options.

Option 352 adds indoor and outdoor mapping capability to FieldFox analyzers, so that FieldFox can import maps from OpenStreetMap (OSM) for data collection and data plotting to the map directly on the FieldFox instrument display. The FieldFox indoor and outdoor mapping feature resides at the System level and the mapping capability can be enabled within the following modes:

- Channel Scanner (Option 312)
- Phased Array Antenna Support (Option 360)
- Over-the-Air (OTA) LTE/TDD FDD (Option 370/371)
- Over-the-Air (OTA) 5G NR (Option 378)
- Indoor and outdoor mapping (Option 352) requirements:
- GPS receiver (Option 307), required for outdoor mapping

OSM maps can be saved to the FieldFox internal memory, SD card or USB drive. This can be done via a direct wired LAN connection or OSM maps can be downloaded and saved to FieldFox using the [FieldFox Map Support Tool](#).

	Description
Map coordinates	Latitude, longitude
Map zoom levels	4 to 17
Map icons	Flag, point, line
Map labels	On, Off
Map panorama	North, South, East, West
Data logging	Record, recall and playback
Indoor map file type	PNG

Using a direct wired LAN connection, FieldFox will automatically access OSM once location coordinates (latitude and longitude) and zoom levels are entered the Map Explorer menu. If using the FieldFox Map Support Tool, OSM map files can be downloaded to a .zip file and imported to FieldFox internal memory. If the FieldFox GPS receiver is enabled and OSM maps have been previously saved to FieldFox with those GPS coordinates, FieldFox can automatically load the corresponding map to match the GPS coordinates.

EMF Measurements (Option 358)

The performance listed in this section applies to the electromagnetic field (EMF) measurement capabilities available in the following models:

Description	Model number
FieldFox RF (combination) analyzers	N9912C, N9913C, N9914C, N9915C
FieldFox RF spectrum analyzers	N9933C, N9934C, N9935C

See [FieldFox Configuration Guide](#) for option information. Many capabilities listed in this Data Sheet require options.

	Description
Supported antenna	AGOS Advanced Technologies, Triaxial Isotropic Antenna Model: SDIA-6000 (or, 85572A-006 if ordered directly from Keysight) Frequency coverage: 30 MHz to 6 GHz Schwarzbeck, Triaxial antenna Model: FSH3D Frequency Range: 9kHz-200MHz
Supported operating modes	Spectrum analyzer: 4 traces (active, min, max and average) and standard (limit) Channel scanner: average table view: average, min, max, standard Over-the-Air (OTA) 5G NR, LTE 89601C VSA
Antenna axis	Average all (Isotropic), X-axis, Y-axis, Z-axis
Measurement	Field Strength, Power Flux Density, Spectrum View (spectrum analyzer mode) EMF total value EMF values reported As % of limit line (linear unit) EMF Table View (Segmented Spectrum Table) EMF values reported by segment (% of total) EMF values reported as % of reference channel (total band) Pass/Fail testing according to user defined limits
Units	Spectrum analyzer mode and channel scanner: dBV/m, dBmV/m, dBuV/m, dBm/m2, V/m, mV/m, Watt/cm2, W/m2, dBµA/m, dBG, dBpT, ratio (%) to user selected limit Over-the-Air (OTA) 5G NR mode: V/m, dBµV/m
Measurement time	Live Continuous User Defined Time Average User Defined Spatial Average
Channel and band configuration	Support for user defined band configuration (segmented spectrum) Start/Stop Frequency, RBW, Display Units Averaging Method: time, spatial (number of averages) Support for user defined limit lines All configuration files are stored internally or uploaded from external PC
Data logging	Record, recall and playback data, save trace and state, GPS
Limit line	Name, start/stop frequencies for each segment, upper and lower limits, unit (E field and H field), range in % (actual value to limit ratio at each frequency point or channel or band), limit line saved as csv format. Multiple limits (csv files) can be uploaded.
Average	Duration in time and spatial in number of average points / captures or manual incremental mode using single sweep
Supported file types	Spectrum analyzer mode: CSV Limit Lines: CSV Channel scanner and table view: CSV

Saving data

Save/recall recorded data logs to/from internal memory or external USB or SD card
 Upload/download logs, CSV, screen capture with [FieldFox DataLink Software](#)

AM/FM Analog demodulation, Tune and Listen (Option 355)

The performance listed in this section applies to the AM/FM analog demodulation, tune and listen capabilities available in the following models:

Description	Model number
FieldFox RF (combination) analyzers	N9912C, N9913C, N9914C, N9915C
FieldFox RF spectrum analyzers	N9933C, N9934C, N9935C

See [FieldFox Configuration Guide](#) for option information. Many capabilities listed in this Data Sheet require options.

	Description
Display type	RF spectrum view, demodulated waveform, including peak+ and peak- traces
Audio demodulation type	AM, FM narrow, FM wide, listen to the tones using FieldFox's built-in speaker or headphones
Audio bandwidth	16 kHz
Measurement type	RF carrier power (dBm), RF carrier frequency (Hz), modulation rate (Hz), SINAD (dB), THD (%)
Receiver bandwidth	Nominal
AM	35 kHz
FM narrow	12 kHz
FM wide	150 kHz
Listen time range	0 to 100 seconds
AM & FM metrics	
SINAD	2.5 dB to 65 dB
THD	0 to 75%
AM measurements	
Maximum modulation rate	5 kHz, demod sweep time: 50 μ s to 50 ms
Depth	(peak-to-peak/2) (%), \pm peak depth (%)
Depth accuracy	\pm 2%
Depth range	Modulation: 0.1 % to 99%
FM measurements	
Maximum FM deviation and maximum FM rate	FM deviation and FM rate must satisfy Carson's formula for the frequency span used: $2 * (\text{max FM deviation} + \text{max FM rate}) < \text{frequency span}$
Frequency deviation	(Hz), \pm peak deviation (Hz)

Radio standards

With a radio standard applied, pre-defined frequency bands, channel numbers or uplink / downlink selections can be used instead of manual frequency entry. The pre-defined FieldFox radio standards include bands such as W-CDMA, LTE, and GSM. Alternately, users can create custom standards and import them into FieldFox analyzers.

Spectrum Analyzer Time Gating (Option 238)

With time gating, you can measure the spectrum of a periodic signal during a specified time interval. Pulsed-RF signals are an example of a periodic signal that can be measured with time gating. For example, you can measure the pulse during the on period, not the transition or the off period. Or you can exclude interfering signals such as a periodic transient. Time gating allows you to view spectral components that would otherwise be hidden. FieldFox's time gating method is a Gated FFT.

	Description
Gate method	Gated FFT
Span range	Any span
RBW range	1 Hz to 300 kHz (derived from gate width)
Gate delay range	-150 ms to 10 s
Gate width (length) range	6 μ s to 1.8 s
Gate sources	External, RF burst, Video

Reflection Measurements (RL, VSWR) (Option 320, applicable to SA only models)

The performance listed in this section applies to the reflection measurements capabilities available in the following models:

Description	Model number
FieldFox RF spectrum analyzers	N9933C, N9934C, N9935C

See [FieldFox Configuration Guide](#) for option information. Many capabilities listed in this Data Sheet require options.

	Models	Reflection measurements
N993xC	N9933C	3 kHz to 4 GHz
	N9934C	3 kHz to 6.5 GHz
	N9935C	3 kHz to 10 GHz
Measurements		
Return loss, VSWR normalization using data/memory (requires Option 220 tracking generator)		

Extended Range Transmission Analysis (ERTA) (Option 209)

ERTA specifications apply to the following FieldFox models. The RF & microwave analyzers must be equipped with the spectrum analyzer option.

Description	Model number
FieldFox RF (combination) analyzers	N9913C, N9914C, N9915C (N9912C excluded)
FieldFox RF spectrum analyzers	N9933C, N9934C, N9935C

See [FieldFox Configuration Guide](#) for option information. Many capabilities listed in this Data Sheet require options.

System description

ERTA can be used to measure the scalar transmission gain or loss of an RF system. It is useful when measuring long lossy cables where the two ends cannot easily be brought together, such as those bolted in on ships or aircrafts. It is also useful in measuring the insertion loss of waveguide systems, or using the frequency-offset feature, devices such as mixers and converters.

ERTA measurements are based on two FieldFox units; one at each end of the measured DUT. One FieldFox is the source and reference receiver (R), while the other is the measurement receiver (B). The two FieldFox units are synchronized using hardware triggering. By taking advantage of FieldFox's InstAlign technique, ERTA can be used to make accurate gain or loss measurements.

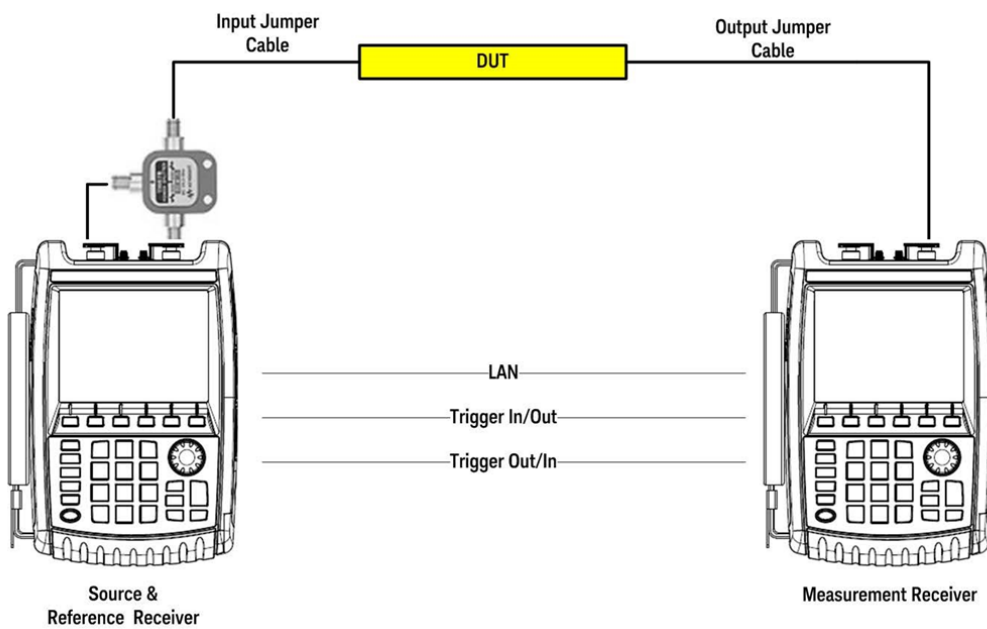

ERTA

Frequency specifications

The ERTA frequency range is limited by each individual analyzer's frequency range.

	Models	Source frequency range	Receiver frequency range
N991xC, N993xC	N9913C, N9933C	3 kHz to 4 GHz	3 kHz to 4 GHz
	N9914C, N9934C	3 kHz to 6.5 GHz	3 kHz to 6.5 GHz
	N9915C, N9935C	3 kHz to 10 GHz	3 kHz to 10 GHz

Frequency reference

Refer to the frequency accuracy specifications.

Source output power

Refer to the test port output power typical data.

Frequency setup parameters

Receiver frequency	Center/span or start/stop (standard spectrum analyzer settings) Reverse receiver sweep direction (default direction is forward, but can be set to reverse)
Source frequency [Remote]	[Tracking] – FieldFox source tracks the receiver by default. The frequencies are identical. [CW] – FieldFox's source can be set to a CW frequency independent of FieldFox's receiver frequency. FieldFox's source is at a single CW frequency; FieldFox's receiver is swept. [Coupled CW] – FieldFox's source CW frequency is auto-coupled to FieldFox's receiver [Center Frequency] setting.

Frequency-offset capability

This feature allows the FieldFox's source frequency to be offset from FieldFox's receiver frequency. The offset frequency can be negative, zero, or positive. The frequency-offset capability is useful when characterizing the scalar transmission response of devices such as mixers and converters.

Frequency-offset setup parameters

Receiver frequency	Center/span or start/stop (standard spectrum analyzer settings) Reverse receiver sweep direction (default direction is forward, but can be set to reverse)
Frequency tracking offset	On/Off Offset values: 0, > 0, < 0
Receiver sweep direction	Reversal: Off Default setting Both source and receiver sweep in the forward direction. Receiver stop frequency > Receiver start frequency Source frequency = Offset + Receiver frequency Reversal: On Source and receiver sweep in opposite directions. Source frequency = Offset – Receiver frequency Offset > receiver frequency

Built-in Power Meter (Option 310)

The performance listed in built-in power meter, external USB power sensor support, pulse measurements, USB power sensor measurements versus frequency sections applies to the capabilities available in the following models:

Description	Model number
FieldFox RF (combination) analyzers	N9912C, N9913C, N9914C, N9915C
FieldFox RF spectrum analyzers	N9933C, N9934C, N9935C

See [FieldFox Configuration Guide](#) for option information. Many capabilities listed in this Data Sheet require options.

Using the built-in power meter, FieldFox is able to make very accurate channel power measurements. The channel bandwidth can be set wide to simulate average power meter measurements. This measurement function provides the flexibility to make user definable channel power measurements.

Description		
Setup parameters	Center frequency, including selection of radio standards and channel selection, span or channel width	
Functions	Relative/absolute measurements, offsets, units of dBm or Watts, or dB or %, minimum and maximum limits	
Models	Options	Frequency range
N9912C	SA4 and 310	3 kHz to 4 GHz
	SA6 and 310	3 kHz to 6.5 GHz
	SAX and 310	3 kHz to 10 GHz
N9913C	233 and 310	3 kHz to 4 GHz
N9914C	233 and 310	3 kHz to 6.5 GHz
N9915C	233 and 310	3 kHz to 10 GHz
N9933C	310	3 kHz to 4 GHz
N9934C	310	3 kHz to 6.5 GHz
N9935C	310	3 kHz to 10 GHz

Total absolute amplitude accuracy (dB)

10 dB attenuation, input signal -15 to -5 dBm, peak detector, 300 Hz RBW, all settings auto-coupled, includes frequency response uncertainties. No warm-up required.

N991xC, N993xC	Frequency	Spec (-10 to 55 °C)	Typical (-10 to 55 °C)
	3 kHz to 100 kHz	±1.00	±0.20
	≥ 100 kHz to 15 MHz	±0.80	±0.15
	≥ 15 MHz to 500 MHz	±0.80	±0.15
	≥ 500 MHz to 4.5 GHz	±1.00	±0.15
	≥ 4.5 GHz to 10 GHz	±1.00	±0.20

External USB Power Sensor Support (Option 302)

The external USB power sensor option supports various Keysight USB power sensors. For an up-to-date listing of the supported power sensors, visit <http://www.keysight.com/find/fieldfoxsupport>

	Description
Setup parameters	Frequency
Functions	Relative/absolute measurements, offsets, units of dBm or Watts, or dB or %, minimum and maximum limits.
Internal source	FieldFox's internal source can be turned on in the USB power sensor mode. CW frequency and nominal power level control are available.

Pulse Measurements (Option 330)

FieldFox's pulse measurement option can be used to characterize RF pulses such as those used in radar and electronic warfare systems. Measurements are made using FieldFox and Keysight's USB peak power sensors.

Performance specifications such as frequency, dynamic range and minimum pulse width depend on the peak power sensor. Supported peak power sensors: <http://www.keysight.com/find/fieldfoxsupport>

	Description
Setup parameters	Frequency, time (center), time/division, gating, triggering, video bandwidth, averaging
Functions	Average power, peak power, and peak to average ratio
	Analog gauge display and digital display, dBm and Watts
	Relative/absolute measurements, offset, dB or %, minimum and maximum limits
	Trace graph for pulse profiling with gating
	Rise time, fall time, pulse width, pulse period, pulse repetition frequency

USB Power Sensor Measurements versus Frequency (Option 208)

This feature allows FieldFox's source frequency to be set independently from the power sensor (receiver) frequency. With frequency-offset using power sensor (FOPS), the frequency of both the source and receiver are swept, and the two track each other. The offset frequency can be negative, zero, or positive.

FOPS can be used to characterize the scalar transmission response of devices such as mixers and converters. This frequency-offset capability is necessary for conversion loss/gain measurements on frequency-translating devices, since by definition, the input and output frequencies of the DUT are different. The FieldFox source stimulates the DUT and the power sensor is used as the measurement receiver.

Since power sensors are inherently broadband devices (not frequency-selective), the user should ensure that only the signal of interest is present at the power sensor input and that all other signals are filtered appropriately.

Setup parameters

Source frequency	Center/span or start/stop
Receiver frequency	Range determined by power sensor range
Frequency offset	Positive offset or negative offset
Frequency step size	30 kHz minimum
Number of points	2 to 1601 (Combination of number of points and frequency step size limited by span.)
Dwell time/point	0 to 1.0 sec

Source frequency span must be equal to receiver frequency span.

Receiver sweep direction: forward (default setting) or reverse.

For some DUTs, the output frequency may sweep in a reverse direction, as compared to the source frequency. The basic relationships between the source, receiver and offset frequencies are shown in the table below. The FieldFox analyzer includes an offset calculator that ensures a fast measurement setup.

Source sweep direction	Receiver sweep direction	Frequency calculations
Forward $f_{2src} > f_{1src}$	Forward $f_{2rx} > f_{1rx}$	Receiver frequency = Source frequency \pm Offset
Forward $f_{2src} > f_{1src}$	Reverse $f_{2rx} > f_{1rx}$	Receiver frequency = Offset - Source Frequency Offset > Source frequency

	Description
Measurements	Source power, gain/loss and receiver (Rx) power Gain = Rx power / source power (memory). Source power (memory) is measured during setup.
Output power	Refer to the test port output power typical data on page 5.
Dynamic range	The dynamic range with FOPS is dependent on FieldFox's output power and the power sensor's dynamic range. Supported USB power sensors: www.keysight.com/find/fieldfoxsupport

The graph below shows a filter measurement using two different power sensors, the U2002A (- 60 to +20 dBm) and the U2021XA (- 45 to +20 dBm). While a filter is not commonly measured using FOPS, it is a useful device for demonstrating dynamic range.

For both measurements, the FieldFox source power was set to - 1 dBm, the maximum available in the selected frequency range of 7.25 to 13.25 GHz. An external amplifier was not used in this case, but one can be added to increase the source power and hence dynamic range.

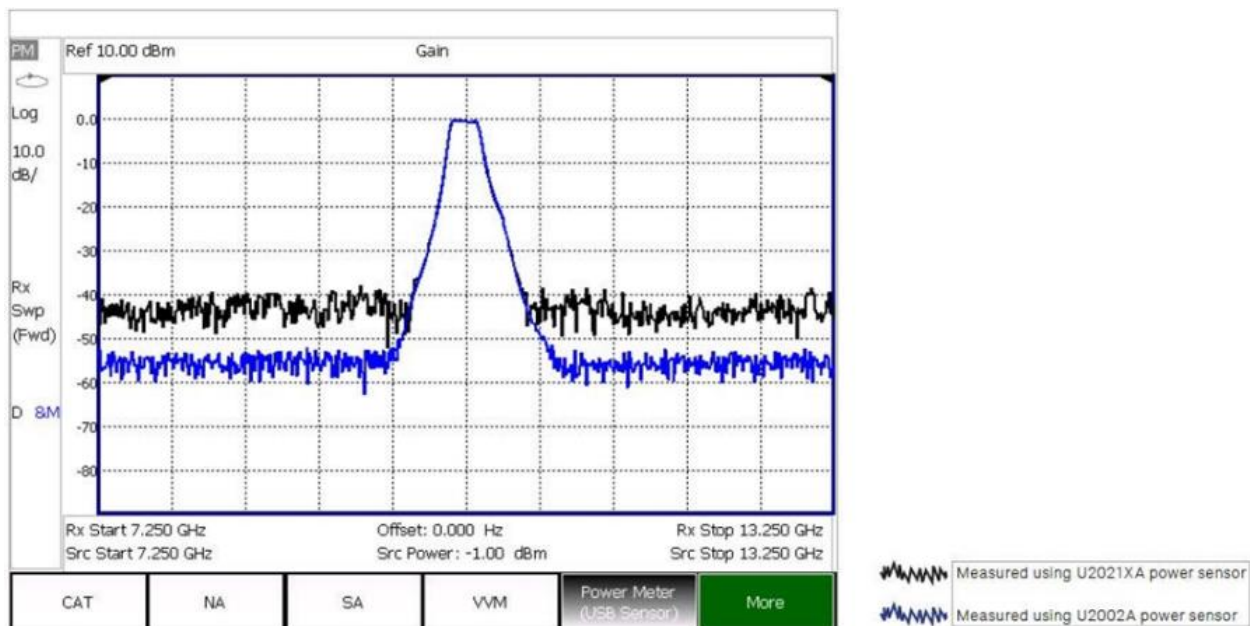

Example showing typical dynamic range of FOPS

Built-In GNSS (GPS+) Receiver (Option 307)

	Description
GNSS (GPS+) receiver	The internal GNSS/GPS receiver can be used as a frequency reference. ¹
Supported systems	GPS, GLONASS, BeiDou and Galileo
Modes	Off, internal, external
Sync clock	On, Off
Functionality	Geo-location: latitude, longitude, altitude (elevation), time, sync time/date
	Requires external GNSS/GPS antenna (can use N9910X-825, GPS active antenna)
Connector for antenna	SMA (f), 3.3 or 5 V
Maximum DC current	20 mA

DC Bias Variable-Voltage Source (Option 309)

	Description
	Nominal
Connector	SMB (m)
Voltage	+1 to +32 V
Resolution	0.1 V
Maximum current ²	0.65 A
DC current readout resolution	0.01 A
Maximum power ²	7 watts
Display read out	Voltage, current
Overload trip protection	Automatically engages when voltage source is on. The trip circuit can be reset from front panel without pre-setting or power cycling the analyzer.

¹ External GPS USB receivers can be used to provide geo-location data. However, they cannot be used for frequency reference locking.

² Battery life will be reduced when DC source is used. A trip function turns off the power supply when the rated current or power is exceeded.

Remote Control Capability (Option 030)

Option 030 adds remote control capability to FieldFox analyzers, so that FieldFox can be controlled via an iOS device, or an Android device. The FieldFox app, running on the iOS/Android device, combined with Option 030 on the FieldFox analyzer provides full control of the instrument from a remote location. The app emulates the front panel of FieldFox, so users can press the FieldFox hard keys or softkeys using their iPhone/iPad, or Android mobile device and make measurements remotely. For example, a tower climber can be on the tower with a FieldFox analyzer, while the technician controls and makes the measurements down below, using an iPhone. The iPhone and FieldFox communicate via a network connection.

iOS device requirements	Android device requirements
iPad, iPhone, or iPod Touch	Android phone or tablet
iOS of 6.1 or higher	Android OS of 9.0 or higher
A WiFi or cellular network connection	A WiFi or cellular network connection

The FieldFox app communicates with FieldFox via a network connection, so both the iOS/Android device and FieldFox need to be on a network where both devices can reach the other. For example, a company intranet or a site installation using a wireless router. FieldFox can directly be connected to a LAN cable, or if wired LAN is not available, a user supplied wireless router can be configured to work with FieldFox. FieldFox does not include a wireless router.

FieldFox app without Option 030

The FieldFox app can be installed on an iOS/Android device independent of the presence of Option 030 on the analyzer. Without Option 030, users can view the live display screen of their FieldFox remotely but cannot control the instrument. With 030 purchased and installed on their FieldFox, users can both view and control their FieldFox. Control refers to the ability to press hard keys, softkeys, make or change measurements, etc. Option 030 does not include the iOS or Android device itself. Users must supply their own iOS or Android device. Option 030 is a license on the FieldFox analyzer. Option 030 and the FieldFox app are not applicable to BlackBerry or Windows phone/tablet devices. FieldFox can be remote controlled via PC software using a wireless or wired LAN connection. FieldFox Data Link software provides a remote display tool with a virtual keypad that allows remote access to the FieldFox display (Option 030 not required).

EMI measurements (Option 361)

	Description
Frequency range	Same as spectrum analyzer frequency range
Number of traces	4, each trace can be configured with individual trace mode and detector type
Trace mode	Max hold, Min, Clear/Write, View and blank. (Average is implemented as EMI average detector)
Detector	Positive Peak, Quasi-Peak, EMI average
CISPR bandwidth	200 Hz, 9 kHz, 120 kHz, 1MHz
Measurements	Frequency scan, CISPR 16-1-1 Amplitude probability distribution (APD)

Pulse Generator (Option 357)

The performance listed in this section applies to the pulse generator capabilities available in the following models:

Description	Model numbers
FieldFox RF (combination) analyzers	N9913C, N9914C, N9915C (N9912C excluded)
FieldFox RF spectrum analyzers	N9933C, N9934C, N9935C

See [FieldFox Configuration Guide](#) for option information. Many capabilities listed in this Data Sheet require options.

Model	Options	Frequency range
N9913C	233 and 357	3 kHz to 4 GHz
N9914C	233 and 357	3 kHz to 6.5 GHz
N9915C	233 and 357	3 kHz to 10 GHz
N9933C	357	3 kHz to 4 GHz
N9934C	357	3 kHz to 6.5 GHz
N9935C	357	3 kHz to 10 GHz

Output signal formats

Continuous wave (CW)	AM: AM triangle, AM sine FM: Sawtooth, FM triangle, FM sine, FSK, BPSK
Pulse	Standard pulse, FM chirp, FM triangle, AM pulse, User-definable sequences

Minimum output frequency

Model	Output signal format	Minimum frequency
N991xC, N993xC	CW, AM triangle, AM sine, BPSK, standard pulse, AM pulse	3 kHz
	FM sawtooth, FM triangle, FM sine, FSK, FM chirp, FM triangle	1.87 MHz

Frequency resolution

Frequency range	Specification
3 kHz to 1.49961 GHz	0.67 Hz
> 1.49961 to 2.99961 GHz	1.34 Hz
> 2.99961 to 5.99961 GHz	1.34 Hz
> 5.99961 to 10 GHz	2.68 Hz

Frequency reference, -10 to +55°C

Accuracy	±0.9 ppm (spec) + aging ±0.5 ppm (typical) + aging
Accuracy, when locked to GPS	±0.01 ppm (spec)
Accuracy, when GPS antenna is disconnected	±0.4 ppm (nominal) ¹
Aging rate	±1 ppm/yr for 20 years (spec), will not exceed ±3.5 ppm

¹ The maximum drift expected in the frequency reference applicable when the ambient temperature changes ±5°C from the temperature when the GPS signal was last connected.

Maximum output power¹

Frequency range	3 kHz to 10 GHz		
	+10 dBm		
Output power range²	Nominal		
Output signal formats	Frequency range	Minimum power	Maximum power
CW, AM triangle, AM sine, BPSK, standard pulse, AM pulse	3 kHz to 1 MHz	-60 dBm	+10 dBm
	1 MHz up to 10 GHz	-110 dBm	+10 dBm
All other formats	For applicable frequencies	-110 dBm	+10 dBm
Output power tuning step	0.1 dB		
Output power accuracy³	Nominal		
	±1 dB		
Reference out/trigger out			
Connector	SMB (m), 50 Ω		
Output amplitude	≥ 0 dBm		
Frequency	10 MHz (1 + frequency reference accuracy)		
Reference in/trigger in			
Connector	SMA (f), 50 Ω		
Reference input	10 MHz, -5 to +10 dBm		
Trigger in	Reserved for future use		

¹ Output power at port 1 connector.

² Settable through UI.

³ Calibrate Pulse Generator prior to implementation using two resistor power splitter and load. Accuracy set by SA's total absolute amplitude accuracy for frequencies above 1 MHz.

General Information

Calibration cycle

1 year

Weight

3.34 kg or 7.35 lb. including battery (approx.) (without removable kickstand)

Dimensions: H x W x D

292 x 188 x 82 mm (11.5 in x 7.4 in x 3.2 in) (approx.) (without removable kickstand)

Environmental

Samples of this product have been type tested in accordance with the Keysight Environmental Test Manual and verified to be robust against the environmental stresses of Storage, Transportation and End-use; those stresses include but are not limited to temperature, humidity, shock, vibration, altitude and power line conditions. Test Methods are aligned with IEC 60068-2 and levels are similar to MIL-PRF-28800F Class 2.

Maximum humidity	Maximum relative humidity (non-condensing): 95% relative humidity up to 40 °C, decreases linearly to 45% relative humidity at 55 °C ¹
------------------	--

Altitude – operating	9,144 m or 30,000 ft (using battery)
----------------------	--------------------------------------

Altitude – Non-operating	15,240 m or 50,000 ft
--------------------------	-----------------------

Altitude – AC to DC adapter	3,000 m or 9,840 ft
-----------------------------	---------------------

Ingress protection

This product has been type tested to meet the requirements for ingress protection IP53 in accordance with IEC/EN 60529 (IP rating for instrument by itself, with no cover).

Temperature range

Operating, AC power, spec ²	-10 to 55 °C (14 to 131 °F) (-10 to 45 °C/14 to 113 °F in RTSA mode)
--	--

Operating, battery, spec	-10 to 50 °C (14 to 122 °F)
--------------------------	-----------------------------

Operating, battery, typical	-10 to 55 °C (14 to 131 °F)
-----------------------------	-----------------------------

Storage, spec ^{3,4}	-51 to 71 °C (-60 to 160 °F)
------------------------------	------------------------------

EMC: Complies with the essential requirements of the European Radio Equipment Directive as well as current editions of the following standards (dates and editions are cited in the Declaration of Conformity)

IEC/EN 61326-1

EN 301 489-1, EN 301 489-19

CISPR Pub 11 Group 1, Class B

AS/NZS CISPR 11

ICES/NMB-001(B)

This ISM device complies with Canadian ICES-001

Cet appareil ISM est conforme a la norme NMB-001 du Canada.

¹ From 40 °C to 55 °C, the maximum % relative humidity follows the line of constant dew point.

² Power supply: 0 to 40 °C at 90 W output rating, derate linearly at 3 watts per degree C, to 45 W at 55 °C, 30 W at -20°C.

³ The battery packs should be stored in an environment with low humidity. Extended exposure to temperature above 45 °C could degrade battery performance and life.

⁴ Power supply: -40 °C to 85 °C (-40 °F to 185 °F).

South Korean Class A EMC declaration

This equipment has been conformity assessed for use in business environments. In a residential environment this equipment may cause radio interference.

사용자 안내문
이 기기는 업무용 환경에서 사용할 목적으로 적합성평가를 받은 기기로서 가정용 환경에서 사용하는 경우 전파간섭의 우려가 있습니다.

※ 사용자 안내문은 "업무용 방송통신기자재"에만 적용한다.

Radio equipment (GNSS): Complies with the essential requirements of the European Radio Equipment Directive:

EN 303 413

Acoustic statement (European Machinery Directive):

Acoustic noise emission
LpA <70 dB
Operator position
Normal operation mode per ISO 7779

SAFETY: Complies with the essential requirements of the European Low Voltage Directive as well as current editions of the following standards (dates and editions are cited in the Declaration of Conformity):

IEC/EN 61010-1
Canada: CSA C22.2 No. 61010-1
USA: UL std no. 61010-1

To find a current Declaration of Conformity for a specific Keysight product, go to:

<http://www.keysight.com/go/conformity>

Explosive environment

This product has been type tested to meet the requirements for operation in explosive environments in accordance with MIL-STD-810G, Method 511.5, Procedure I.

Power supply

External DC input	15 to 19 VDC, 4 amps maximum when battery charging
External AC power adapter	Efficiency level VI
Input	100 to 240 VAC, 50 to 60 Hz, 1.5 to 0.75 A
Output	15 VDC, 6 A
Power consumption	16 to 30 watts (typical) Battery consumption depends on battery saver selection, measurement mode and temperature.

Battery

Lithium ion	10.8 V, 6.4 A-h, 70 Wh
Operating time	4 hours (typical), mode dependent
Charge time	A fully discharged battery takes about 1.5 hours to recharge to 80%. Four hours to 100%.
Discharge temperature limits	-10 to 60 °C, ≤ 85% RH
Charge temperature limits	0 to 45°C, ≤ 85% RH
Storage temperature limits	-20 to 50 °C, ≤ 85 % RH

The battery packs should be stored in an environment with low humidity. Extended exposure to temperatures above 45 °C could degrade battery performance and life.

Test port connectors

Type-N (f)

Display

6.5" transfective color LCD-LED backlit

Headphone jack connector

3.5 mm (1/8 inch) miniature audio jack

USB-A, 2-ports

Hi-speed USB 2.0

Mini USB, 1 port

Hi-speed USB 2.0; used for SCPI programming; USBTMC (USB IEEE488)

Keyboard

USB keyboards are supported (user must supply their own keyboard)

LAN

Connector	RJ-45
	Used for programming, data saving, remote control, and connection to DataLink software
	1000/100/10 base-T (auto switching)
	SCPI over LAN using sockets and VX11 (LAN IEEE488); HTTP

Programming

SCPI, using the built-in LAN interface, PathWave BenchVue

Languages

English, Spanish, German, Italian, French, Russian, Japanese, Chinese, Turkish, Korean, and Portuguese

Preset

User preset for both mode preset and complete system preset

Limit lines

The limit line capabilities listed in this section apply to the cable and antenna analyzer, network analyzer and spectrum analyzer modes in all FieldFox analyzers.

Limit lines can be a combination of horizontal lines, sloping lines, or discrete data points	Max limit line number of points: 10,001
Limit types: Fixed or relative	Beep: Beep off, Beep on fail, Beep on pass
Each trace can have its own limit line	Pass/fail warning: on/off
Limit lines can be built from a current trace	Offset and margin: An increase or decrease in the limit line
Limit segments > 100, limited by memory size	Save/recall limit lines

Data storage

Internal	Internal Minimum: 4 GB Minimum states and traces: 1000
External	Supports USB 2.0 compatible memory devices and SD/SDHC memory cards with FAT and exFAT format
Data types	Trace, trace+state, picture (png), data (csv), S1P, S2P

Secure operation

Frequency blanking	For protection of sensitive data all frequency information can be turned off.
Erase user data	All user data can be erased on a FieldFox analyzer. For more information visit: http://www.keysight.com/find/securefieldfox

Reference out/trigger out

Connector	SMB (m), 50 Ω
Output amplitude	≥ 0 dBm
Frequency	10 MHz (1 + frequency reference accuracy)
Trigger out	Reserved for future use; currently only used for ERTA 2-box handshaking and for pulse generator (Option 357)

Reference in/trigger in

Connector	SMA (f), 50 Ω
Reference input	10 MHz, -5 to +10 dBm
Trigger input	3.3 or 5 V TTL logic levels

FieldFox Physical Dimensions

FieldFox models with Type-N test port connectors

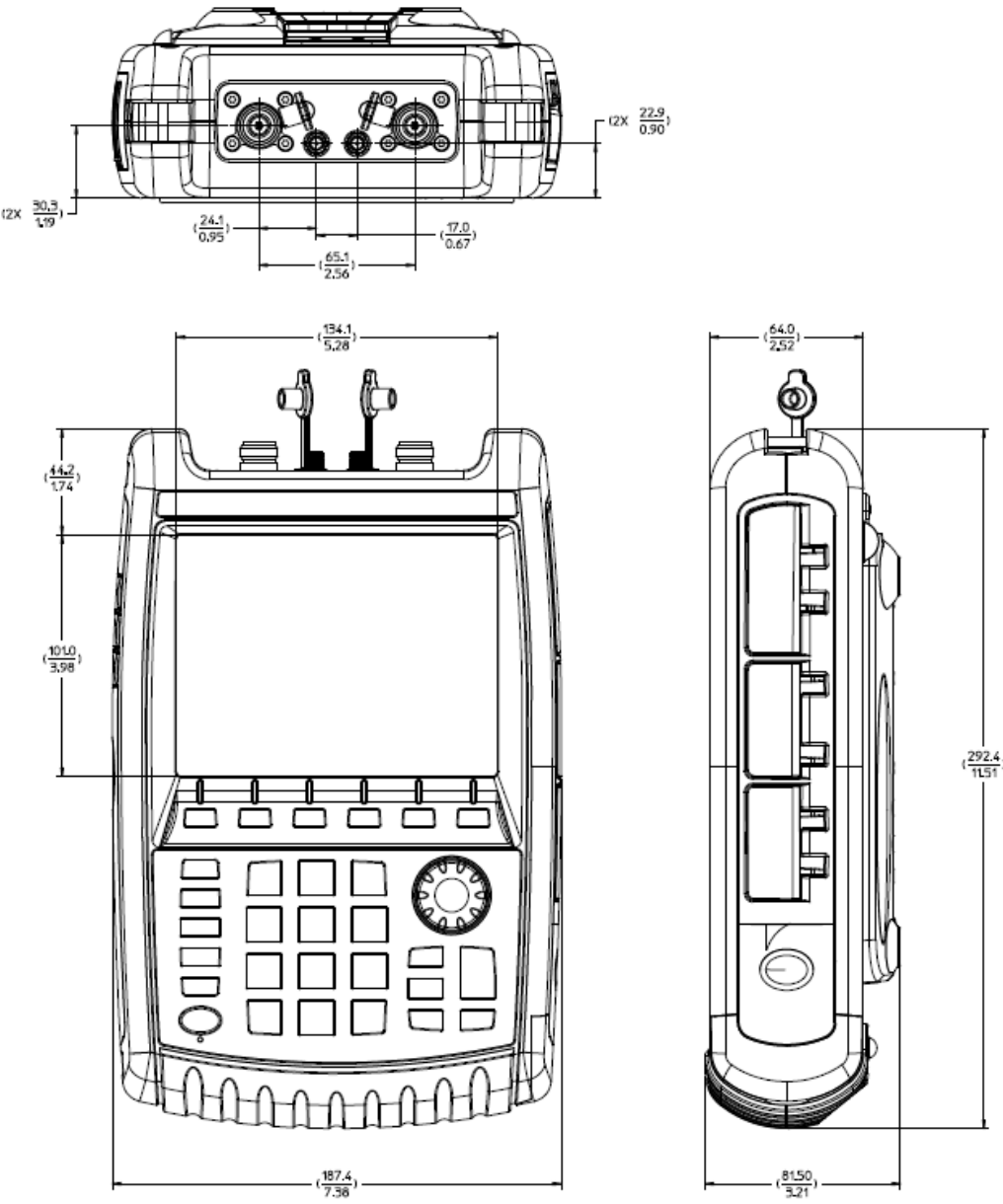

Confidently Covered by Keysight Services

Prevent delays caused by technical questions and reduce system downtime due to instrument maintenance and repairs with Keysight Services. Keysight Services are here to support your test needs with expert technical support, instrument repair and calibration, software support, training, alternative acquisition program options, and more.

A KeysightCare agreement provides dedicated, proactive support through a single point of contact for instruments, software, and solutions. KeysightCare covers an extensive group of instruments, application software, and solutions and ensures optimal uptime, faster response, faster access to experts, and faster resolution.

Keysight Services

Offering	Benefits
KeysightCare 	KeysightCare provides elevated support for Keysight instruments and software, with access to technical support experts who respond within a specified time and ensure committed repair and calibration turnaround times (TAT). KeysightCare offers multiple service agreement tiers, including KeysightCare Assured, Enhanced, and Application Software Support. See the KeysightCare data sheet for details.
KeysightCare Assured	KeysightCare Assured goes beyond basic warranty with repair services that include committed TAT and unlimited access to technical experts.
KeysightCare Enhanced	KeysightCare Enhanced includes all the benefits of KeysightCare Assured plus Keysight's accurate and reliable Calibration Services , accelerated, and committed TAT, and technical response.
Keysight Support Portal & Knowledge Center	All KeysightCare tiers include access to the Keysight Support Portal where you can manage support and service resources related to your assets such as service requests, and status, or browse the Knowledge Center.
Education Services	Build confidence and gain new skills to make accurate measurements, with flexible Education Services developed by Keysight experts. Including Start-up Assistance.
Alternative acquisition options	
KeysightAccess	Reduce budget challenges with a leased-based subscription service, that offers low monthly payments, enabling you to get the instruments, software, and technical support you want for your test needs.

Recommended services

Maximize your test system up-time by securing technical support, repair, and calibration services with committed response and turnaround times. 1-year KeysightCare Assured is included in every new instrument purchase. Obtain multi-year KeysightCare upfront to eliminate the need for lengthy and tedious paperwork and yearly requests for maintenance budget. Plus, you benefit from secured service for 2, 3, or 5 years.

Service	Function
KeysightCare Enhanced*	Includes tech support, warranty and calibration
R-55B-001-1	KeysightCare Enhanced – Upgrade 1 year
R-55B-001-2	KeysightCare Enhanced – Extend to 2 years
R-55B-001-3	KeysightCare Enhanced – Extend to 3 years (Recommended)
R-55B-001-5	KeysightCare Enhanced – Extend to 5 years (Recommended)
KeysightCare Assured*	Includes tech support and warranty
R-55A-001-2	KeysightCare Assured – Extend to 2 years
R-55A-001-3	KeysightCare Assured – Extend to 3 years
R-55A-001-5	KeysightCare Assured – Extend to 5 years
Start-Up Assistance	
PS-S40-01	Included – instrument fundamentals and operations starter
PS-S40-04	Recommended – instrument fundamentals and operations starter
PS-S40-02	Optional, technology & measurement science standard learning

* Available in select countries. For details, please view the [datasheet](#). R-55B-001-2/3/5 must be ordered with R-55B-001-1.

Carry Precision with You

Every piece of gear in your field kit had to prove its worth. Measuring up and earning a spot is the driving idea behind Keysight's FieldFox analyzers. They're equipped to handle routine maintenance, in-depth troubleshooting, and anything in between. Better yet, FieldFox delivers precise microwave measurements — wherever you need to go. Add FieldFox to your kit and carry precision with you.

Related literature	Publication number
FieldFox Handheld Analyzers, Configuration Guide	5992-3701EN
FieldFox Handheld Analyzers, Technical Overview	5992-3703EN



**Ihr Ansprechpartner /
Your Partner:**

dataTec AG
E-Mail: info@datatec.eu
>>> www.datatec.eu



Mess- und Prüftechnik. Die Experten.

Keysight enables innovators to push the boundaries of engineering by quickly solving design, emulation, and test challenges to create the best product experiences. Start your innovation journey at www.keysight.com.

This information is subject to change without notice. © Keysight Technologies, 2023 - 2024, Published in USA, December 20, 2024, 3123-1696.EN