

# HUBERT

amp up your process

## Datasheet

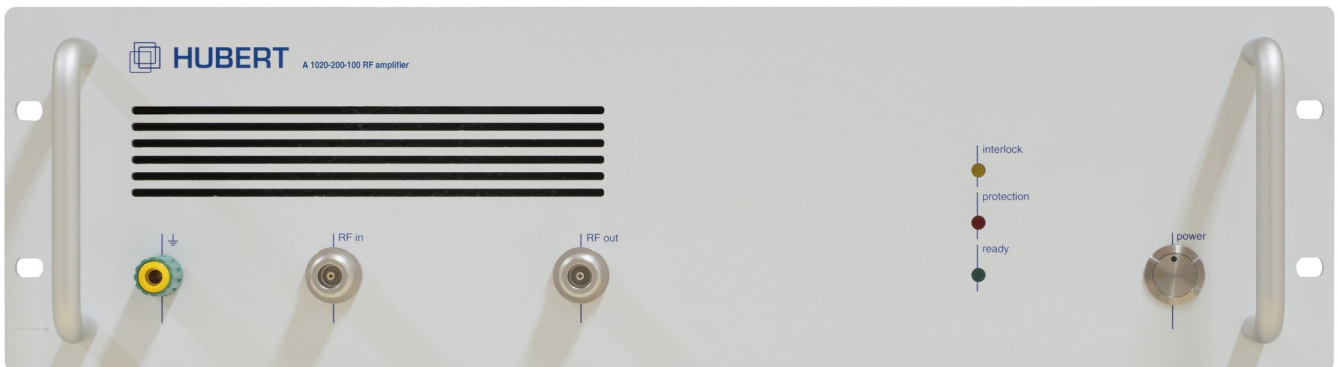

# A1020-200-100

**Linear RF power amplifier**

**100 kHz...100 MHz, min. 200 W**



Mess- und Prüftechnik. Die Experten.

**Ihr Ansprechpartner /  
Your Partner:**

**dataTec AG**  
E-Mail: [info@datatec.eu](mailto:info@datatec.eu)  
>>> [www.datatec.eu](http://www.datatec.eu)

MADE IN GERMANY

Revision 1.0

# 1 Product description

The A1020-200-100 is a broadband RF amplifier in the frequency range 100 kHz...100 MHz with a linear output power of at least 250 W up to 20 MHz and at least 200 W beyond that up to 100 MHz.

A commercially available RF signal generator is required for operation, which is terminated with 50  $\Omega$  when the output is switched off.

The amplifier output is designed for a nominal impedance of 50  $\Omega$ , as is usual with RF amplifiers. It is permitted to connect and operate a load that deviates from this, but the maximum output power cannot then be achieved. For low impedance loads (recommended < 25  $\Omega$ ), a 50  $\Omega$  - 12.5  $\Omega$  matching transformer can be connected between the amplifier and the load to enable better efficiency. The output voltage is halved, whereas the output current is doubled. The same applies to high-impedance loads (recommended > 100  $\Omega$ ) with a 50  $\Omega$  - 200  $\Omega$  matching transformer. With this, the voltage is doubled and the current halved. Both should be connected as close as possible to the load and extends the impedances that can be sensibly connected and thus the possibilities for use and testing.

The matching transformers are optimised for the highest possible bandwidth. On request, other transmission ratios can also be realised, but these can then usually be implemented in a much narrower bandwidth. Contact us with your special requirements. We will check what is feasible for you.

# 2 Features

- Universally applicable RF amplifier from 100 kHz...100 MHz
- Linear output power of up to 250 W from 100 kHz...20 MHz at 50  $\Omega$
- Linear output power of up to 200 W from 20 MHz...100 MHz at 50  $\Omega$
- Linear gain over frequency
- High stability of gain over temperature
- The amplifier can reproduce all known modulation forms of a sinusoidal signal, from amplitude modulation, frequency and phase modulation to pulse modulation and burst signals.
- For operation with all common HF generators.
- Nominal output impedance 50  $\Omega$ , output signal stable at all resistive and complex loads.
- Temperature-controlled fan and overtemperature shutdown
- Overload cut-off for safe operation
- Monitor output (-50 dB @ 50  $\Omega$ ) for interference-free monitoring of the output signal
- Interlock for safe shutdown during test set-ups



- Efficient wide-range power supply with a line factor close to 1
- Optional matching transformers available to 12.5  $\Omega$  or 200  $\Omega$  nominal impedance

### 3 Applications

- Universally applicable in research and development
- Direct supply of all loads with 50  $\Omega$  nominal impedance such as antennas, TEM cells, striplines, coupling networks, coupling clamps, etc.
- Measurements on components such as inductors, transformers, capacitors, etc.
- Piezo actuation
- Supply and measurement of ultrasonic transducers

### 4 Pictures

#### 4.1 A1020-200-100 Frontpanel

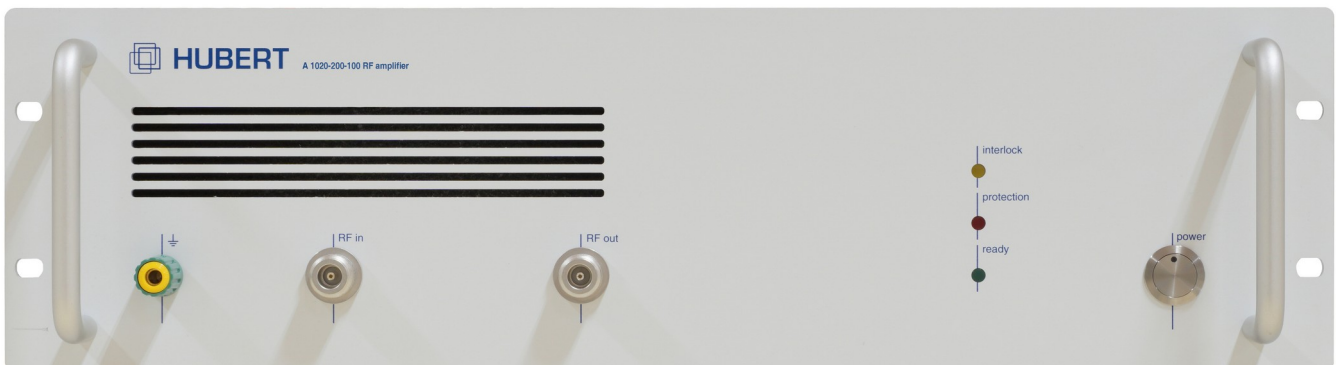

#### 4.2 A1020-200-100 Backpanel





### 4.3 Bidirectional matching transformer MT-2-200

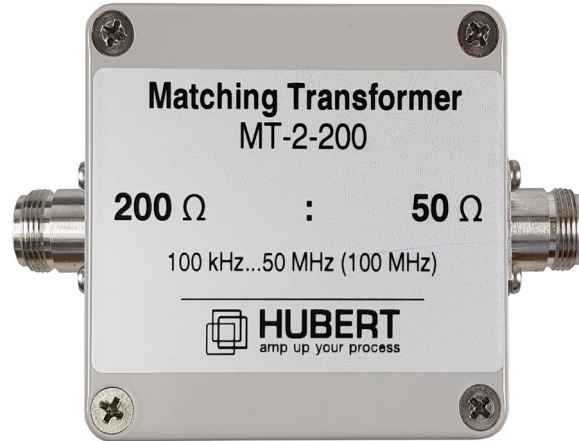

### 4.4 Bidirectional matching transformer MT-2-12.5

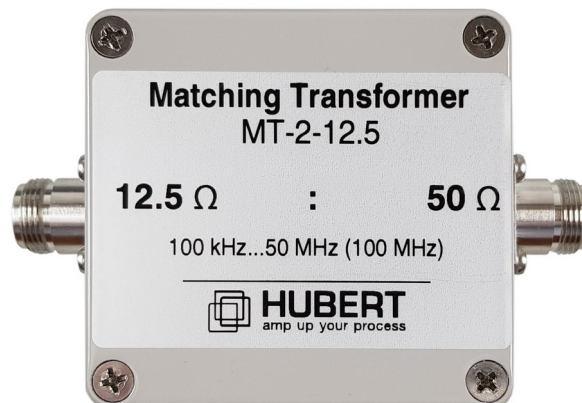



## 5 Specifications

### 5.1 Amplifier A1020-200-100

Parameter	Specifications	Conditions/Moments
		Mains voltage: 230 V 250 C Ambient temperature At least 30 min. warm-up time
Operating mode	Push Pull Class A	
Frequency range	100 kHz...100 MHz	
Signal input		50 $\Omega$ source, 50 $\Omega$ load
Connector	N Socket (50 $\Omega$ )	
Input Impedance	50 $\Omega$ nominal	
Input VSWR	1.3 : 1 max.	
Small signal amplification	+56.5 dB $\pm$ 1 dB	with -20 dBm input power
Input level for nominal power	0 dBm	
Max. Input level	10 dBm	Damage possible if exceeded!
Signal output		
Connector	N Socket (50 $\Omega$ )	
Linear output power		50 $\Omega$ Source, 50 $\Omega$ Load
10 kHz...20 MHz	54 dBm (250 W) min.	<1 dB Compression
20 MHz...100 MHz	53 dBm (200 W) min.	<1 dB Compression
Output signal		
Harmonic	$\leq$ 20 dBc typ.	50 dBm (100 W) Output power
Interference Signals (Spurious)	<100 dBc typ.	50 dBm (100 W) Output power
Noise		Input with 50 $\Omega$ termination, 50 $\Omega$ load
Broadband noise	-21.5 dBm	Measured with NRV-Z51 at NRVD
Monitor output		
Connector	BNC Socket (50 $\Omega$ )	
Amplification	-50 dB $\pm$ 1 dB from output signal	50 $\Omega$ Load
Protective circuit		
Overtemperature	Shutdown at 75 <sup>o</sup> C	Automatic restart at 50 <sup>o</sup> C
Overload at output	Shutdown if supply current is too high	Mains disconnection and reconnection necessary for normal operation!
Interlock		
Connector	BNC Socket (50 $\Omega$ )	



Function	Potential-free closing contact <10 k $\Omega$ necessary for normal operation	Amplifier is switched off, quiescent current drops to near zero
Mains voltage	90...264 V <sub>AC</sub> , 47...63 Hz	
Max. Mains input power	820 W	230 V <sub>AC</sub> Mains voltage
Physical Characteristics		
Operating temperature	10...40 <sup>0</sup> C	
Operating altitude	Max. 2000 m	
Humidity	80% or less at 40 <sup>0</sup> C	non condensing
Degree of pollution	2	
Overvoltage category	CAT II	
Cooling	Temperature controlled fan	Sufficient distance necessary
Dimensions (W x H x D)	448 x 153,6 x 546 mm	with feet and handles
Weight	ca. 14.5 kg	

## 5.2 Matching transformer MT-2-200 (Accessories)

Parameter	Specifications	Conditions/Moments
		25 <sup>0</sup> C Ambient temperature
Frequency range	100 kHz...50 MHz (100 MHz)	Above 50 MHz increased attenuation and mismatch possible
Input power	Max. 250 W	continuous
Operating mode	Unidirectional	
Upward transformation (1:4)	50 $\Omega$ :200 $\Omega$	
Connector	N Socket (50 $\Omega$ )	Both sides
Input impedance	50 $\Omega$ nominal	
Physical Characteristics		
Operating temperature	10...40 <sup>0</sup> C	
Operating altitude	Max. 2000 m	
Humidity	80% or less at 40 <sup>0</sup> C	non condensing
Dimensions (W x H x D)	115x75x60 mm	with connectors
Weight	ca. 0.4 kg	



### 5.3 Matching transformer MT-2-12.5 (Accessories)

Parameter	Specifications	Conditions/Moments
		25° C Ambient temperature
Frequency range	100 kHz...50 MHz (100 MHz)	Above 50 MHz increased attenuation and mismatch possible
Input power	Max. 250 W	continuous
Betriebsart	Unidirectional	
Downward transformation (1:4)	50 Ω :12.5 Ω	
Connector	N Socket (50 Ω)	Both sides
Input impedance	50 Ω nominal	
Physical Characteristics		
Operating temperature	10...40° C	
Operating altitude	Max. 2000 m	
Humidity	80% or less at 40° C	non condensing
Dimensions (W x H x D)	115x75x60 mm	with connectors
Weight	ca. 0.4 kg	



## 6 Block Diagram

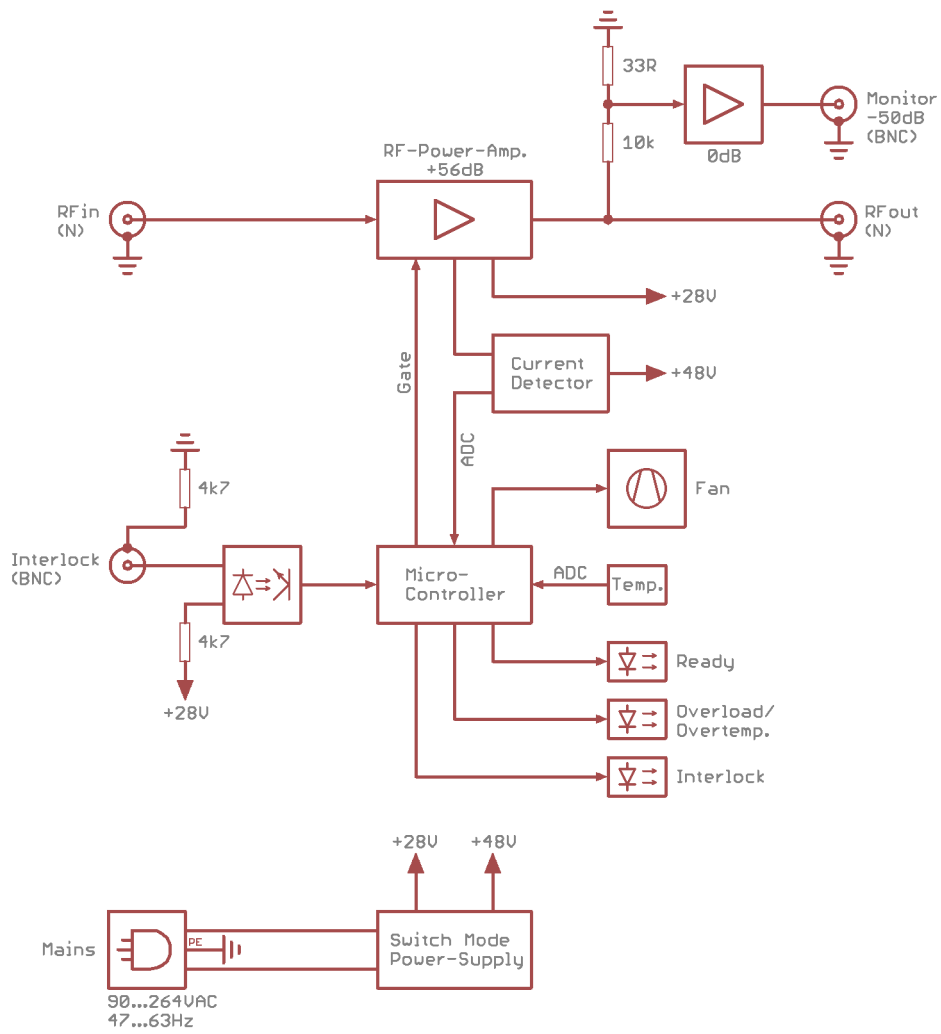





## 6.1 Diagrams A1020-200-100

### 6.1.1 Small signal gain

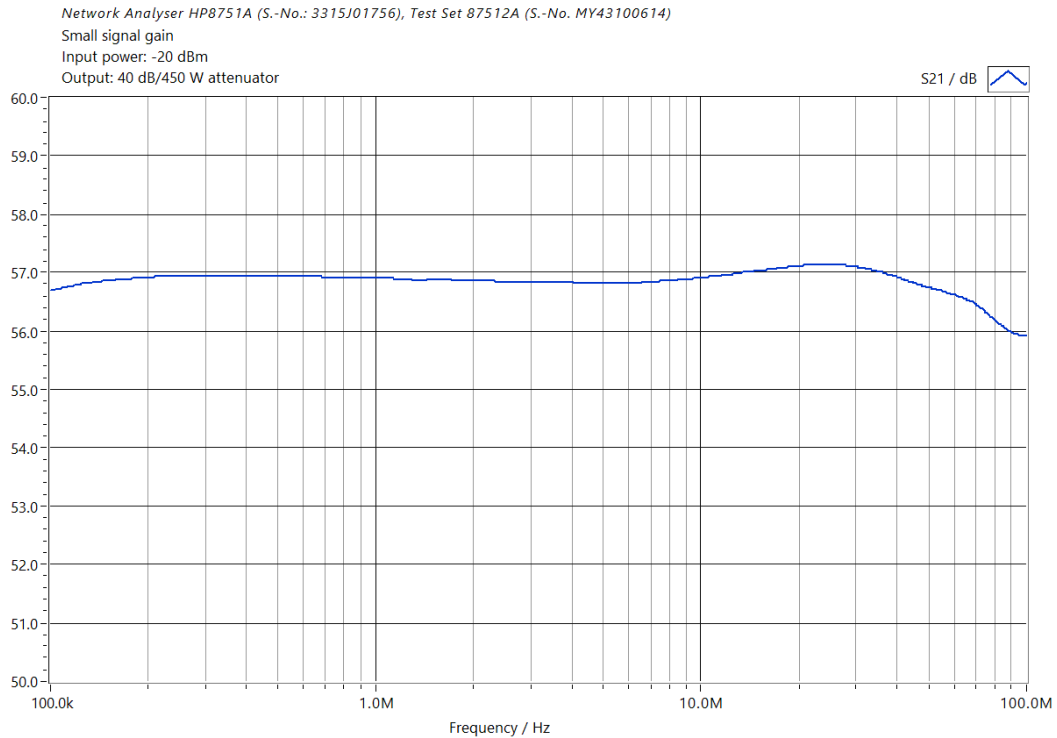

### 6.1.2 Output voltage 100 kHz at 50 $\Omega$

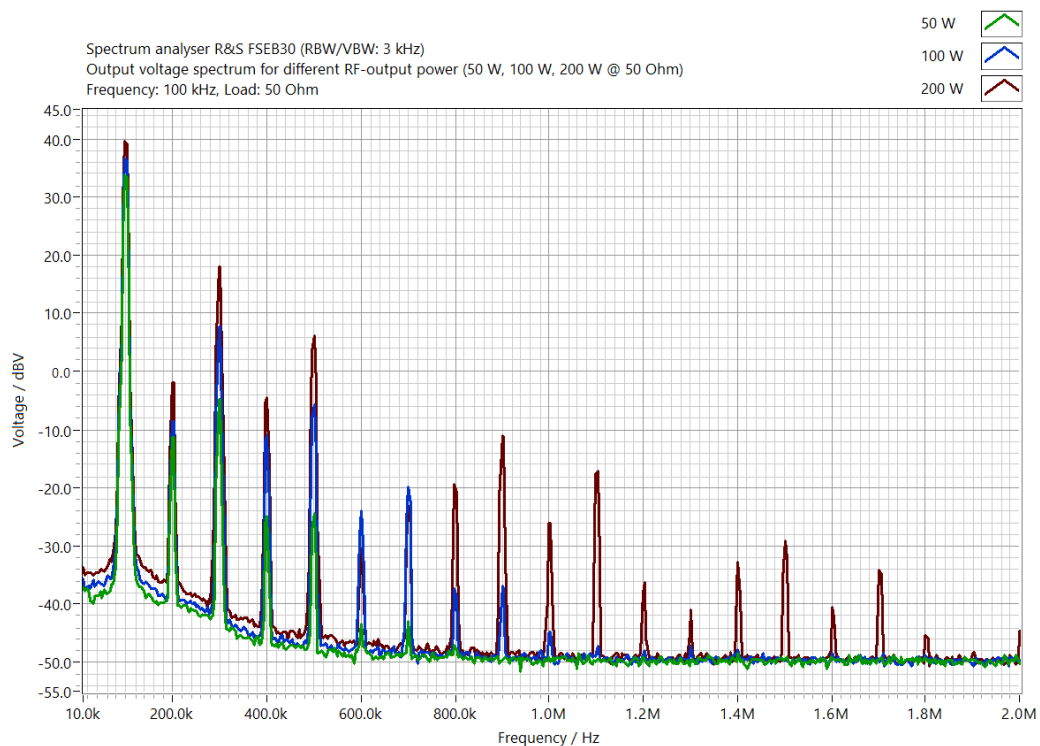



### 6.1.3 Output voltage 1 MHz at 50 Ω

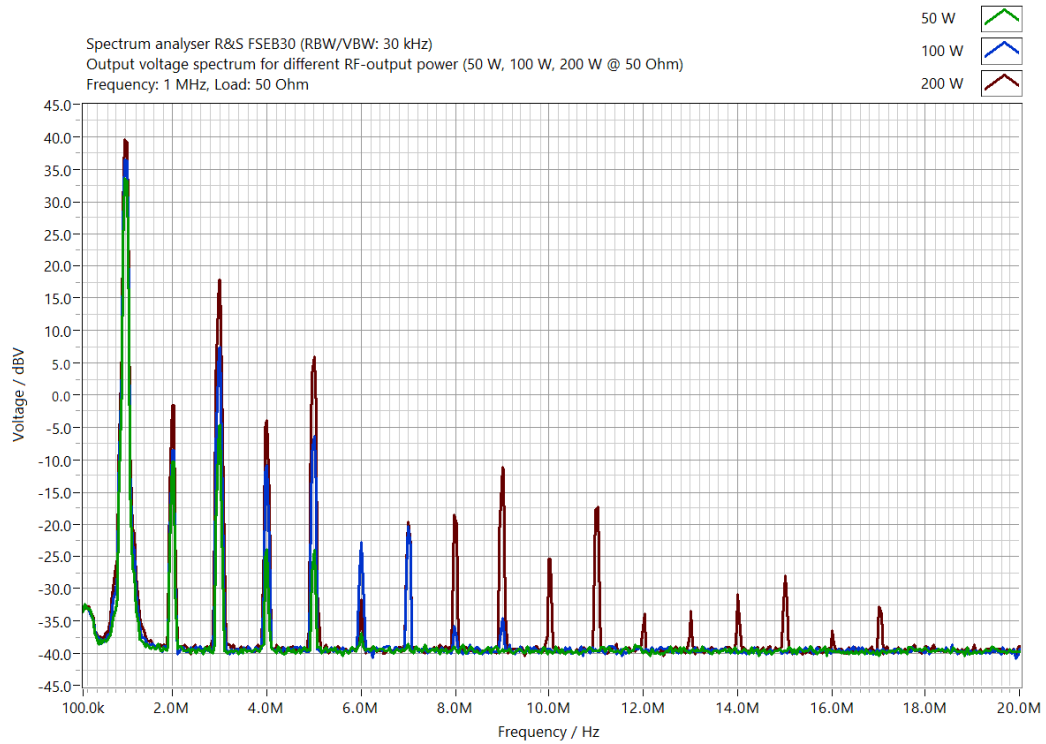

### 6.1.4 Output voltage 10 MHz at 50 Ω

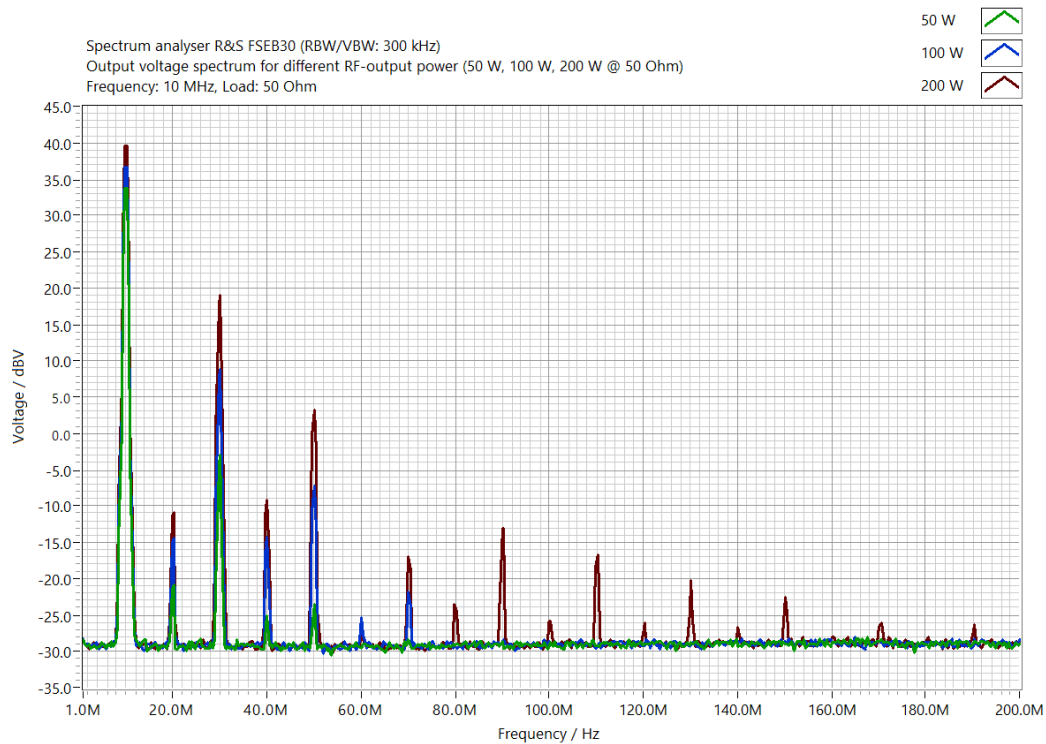



### 6.1.5 Output voltage 50 MHz at 50 $\Omega$

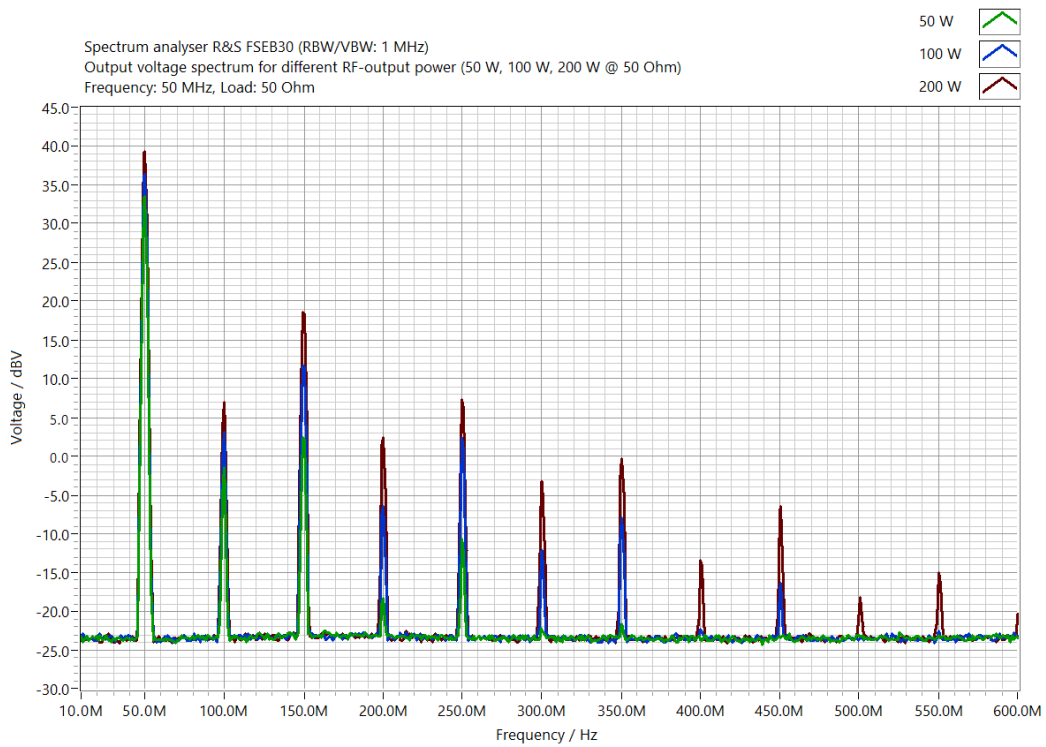

### 6.1.6 Output voltage 100 MHz at 50 $\Omega$

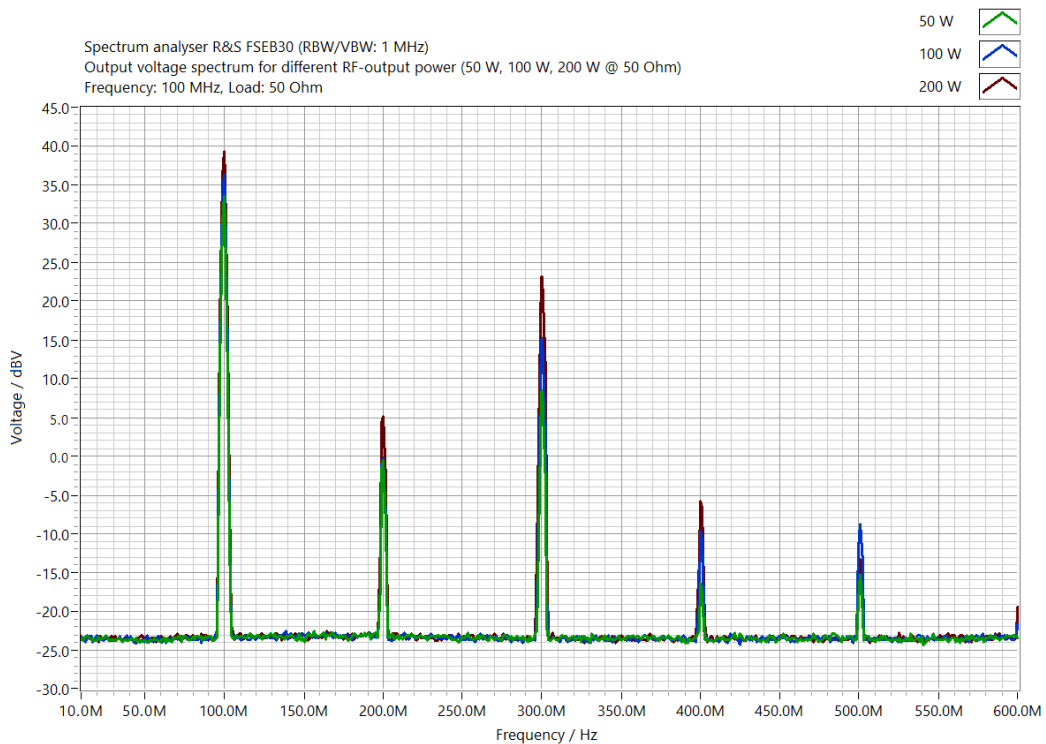



## 6.1.7 Noise at 50 $\Omega$ Load

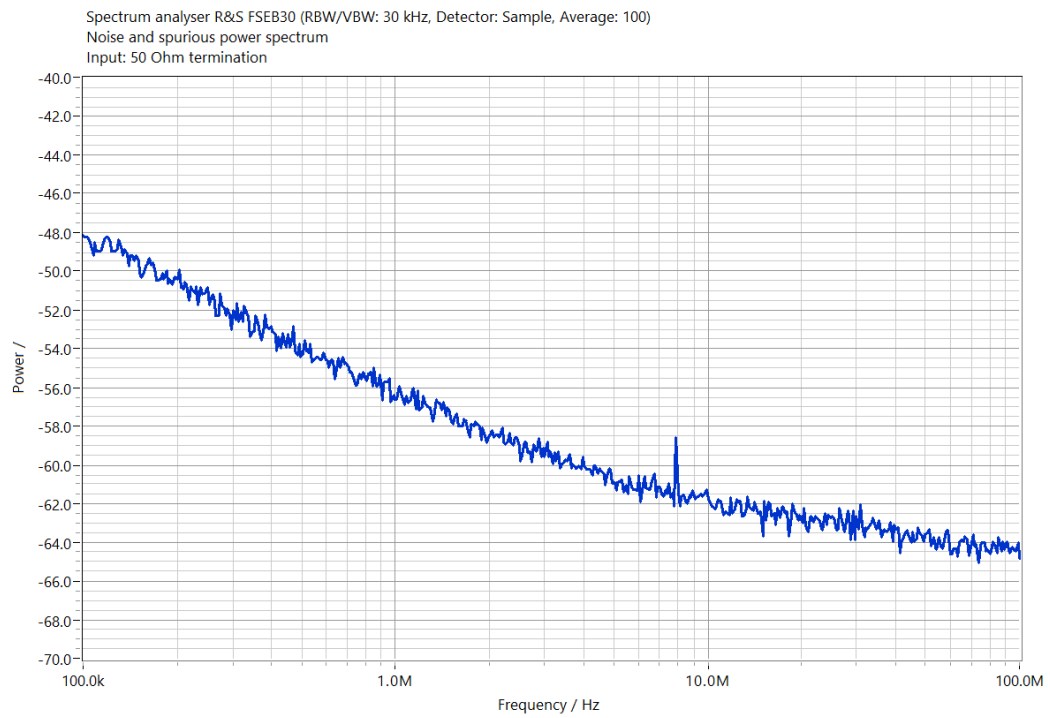



## 6.2 Diagrams with Matching-Transformer MT-2-12.5

### 6.2.1 Output impedance

Network Analyser HP8751A (S.-No.: 3315J01756), Test Set 87512A (S.-No. MY43100614)  
Matching Transformer MT-2-12.5  
Measurement of output impedance, input with 50 Ohm termination

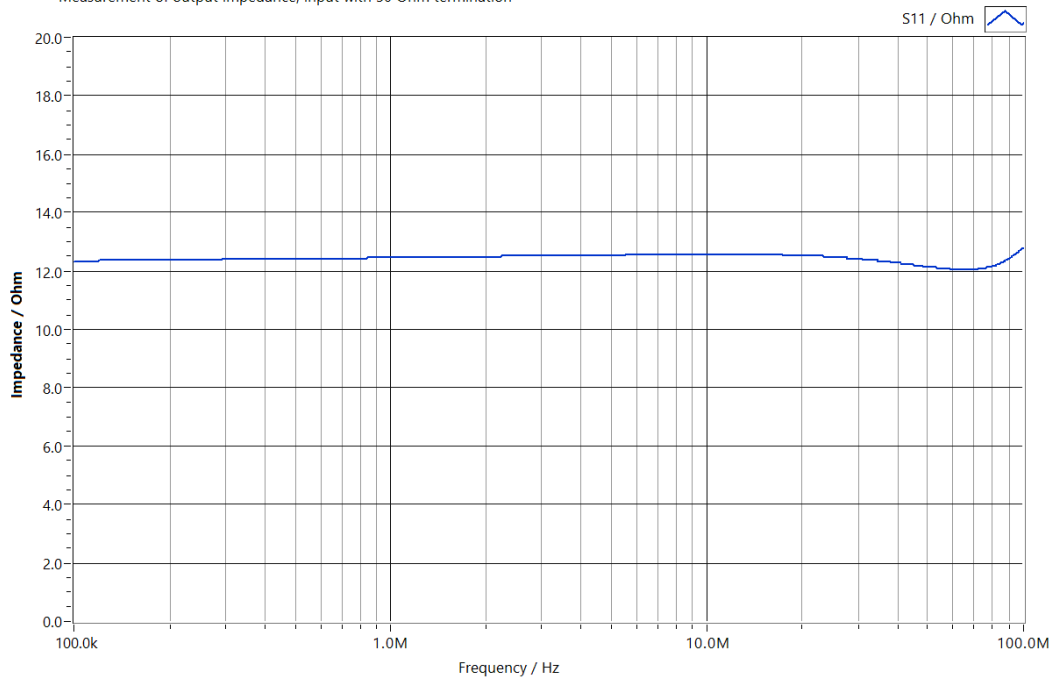

### 6.2.2 Output voltage 100 kHz at 12.5 $\Omega$

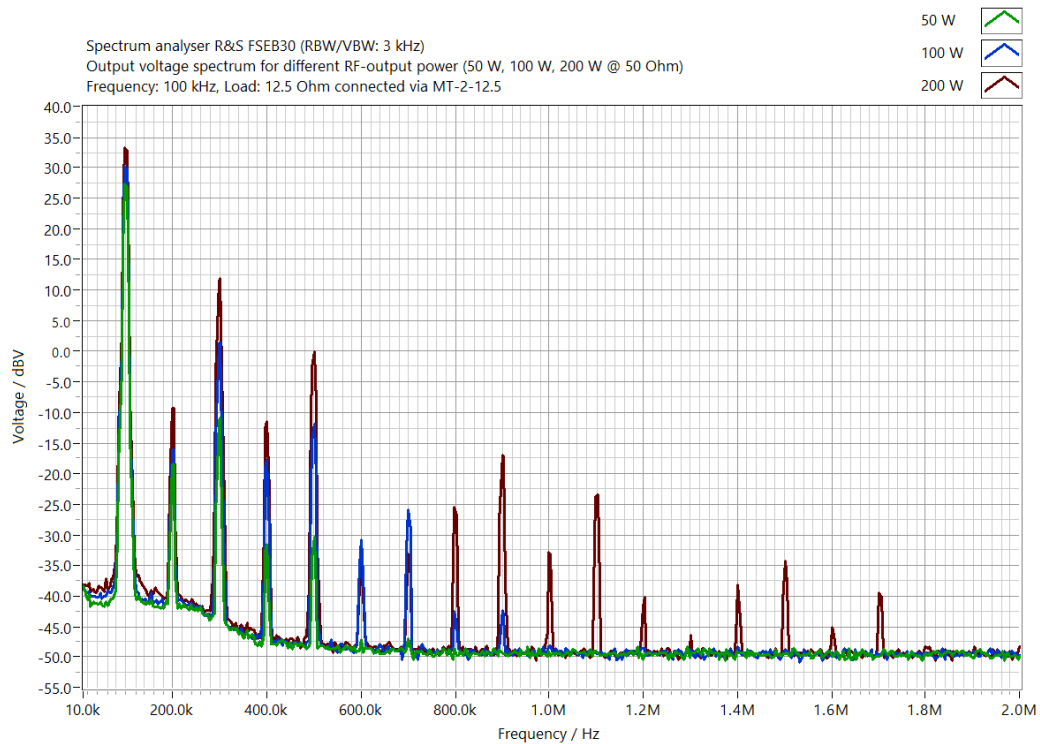



### 6.2.3 Output voltage 1 MHz at 12.5 Ω

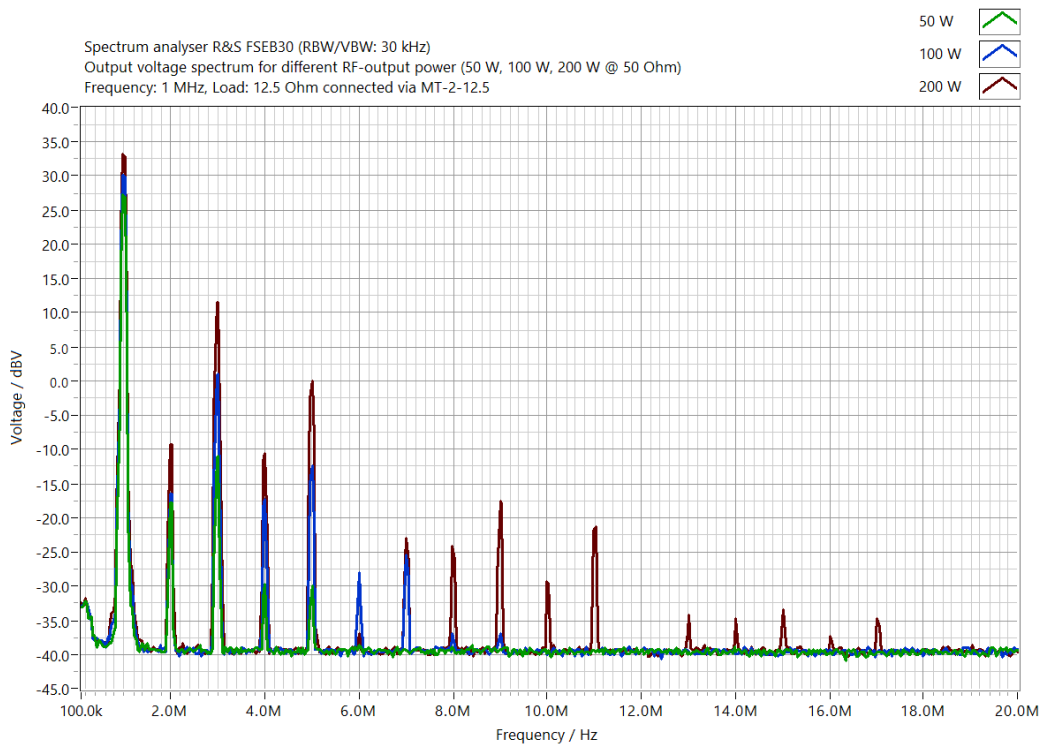

### 6.2.4 Output voltage 10 MHz at 12.5 Ω

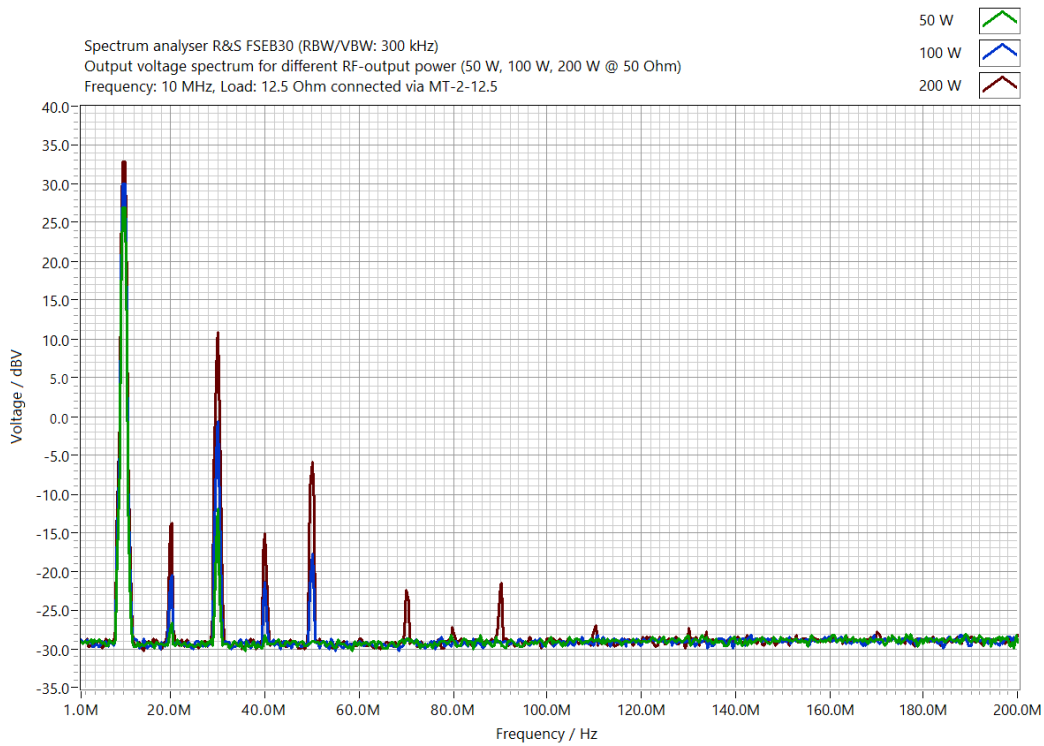



## 6.2.5 Output voltage 50 MHz at 12.5 $\Omega$

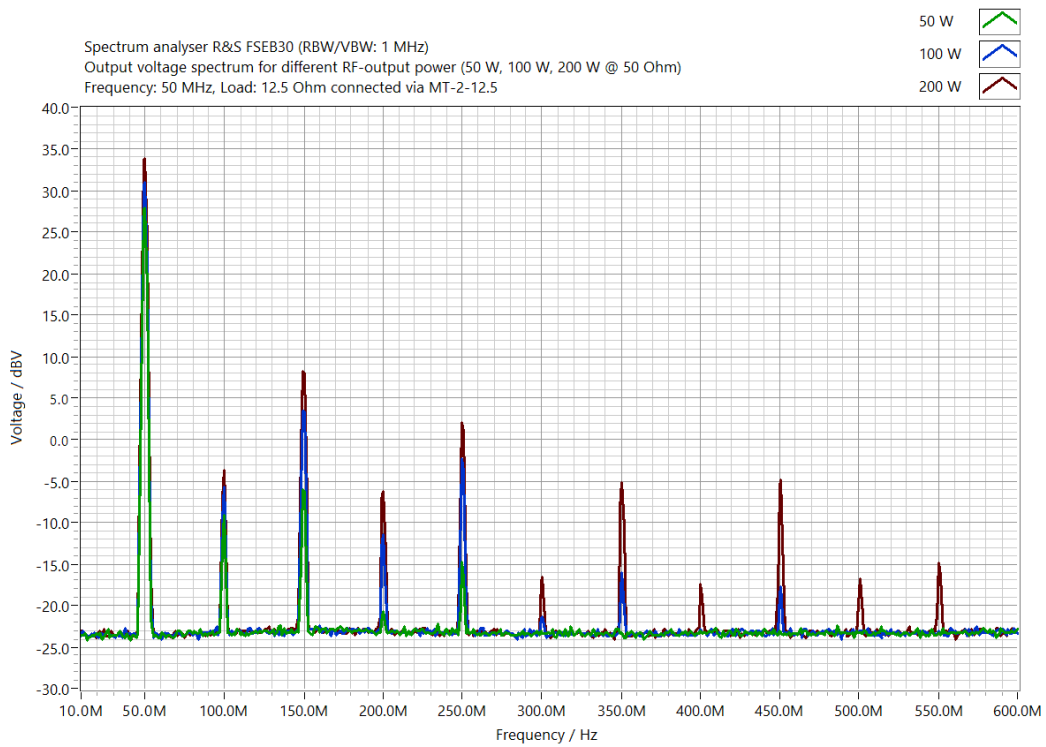

## 6.2.6 Output voltage 100 MHz at 12.5 $\Omega$

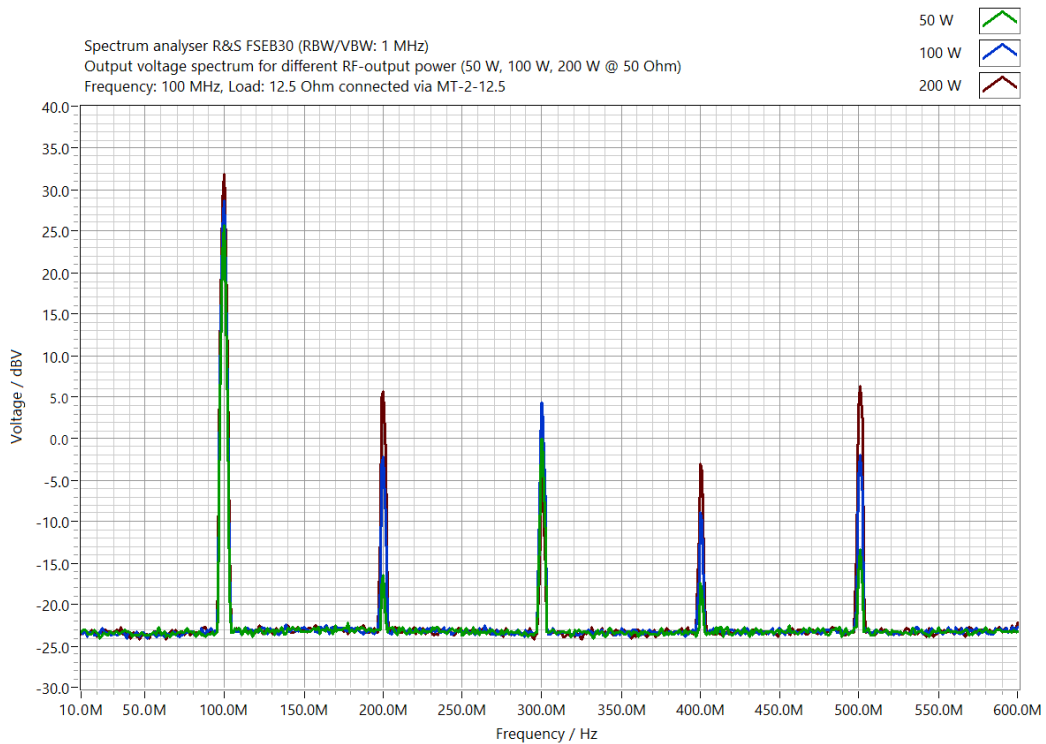



## 6.3 Diagrams with Matching-Transformer MT-2-200

### 6.3.1 Output impedance

Network Analyser HP8751A (S.-No.: 3315J01756), Test Set 87512A (S.-No. MY43100614)  
Matching Transformer MT-2-200  
Measurement of output impedance, input with 50 Ohm termination

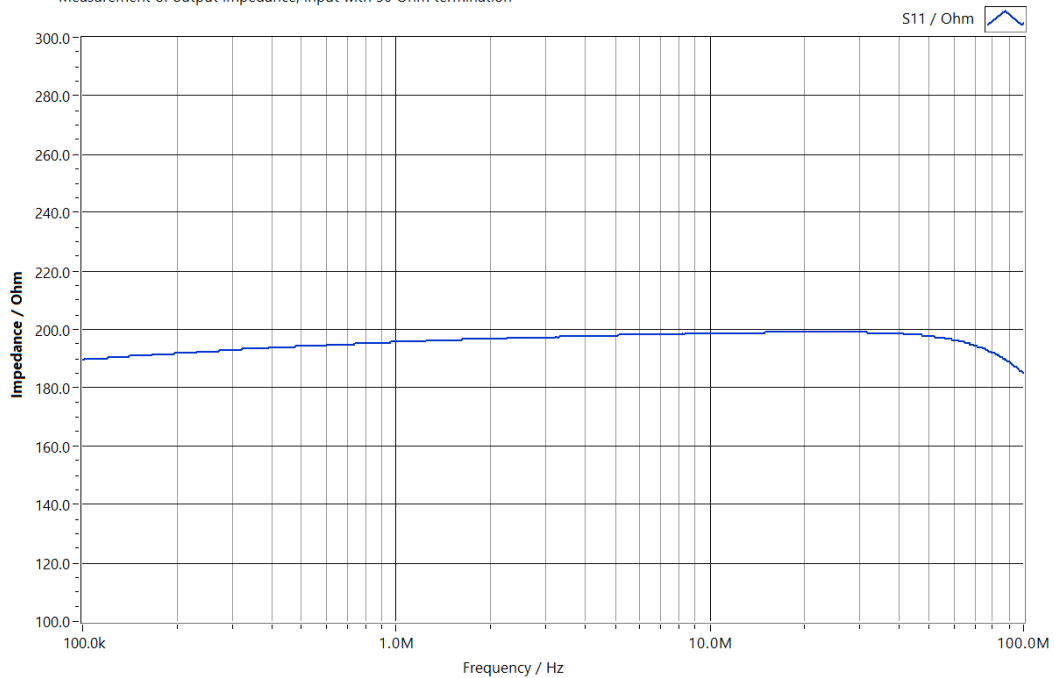

### 6.3.2 Output voltage 100 kHz at 200 Ω

Spectrum analyser R&S FSEB30 (RBW/VBW: 3 kHz)  
Output voltage spectrum for different RF-output power (50 W, 100 W, 200 W @ 50 Ohm)  
Frequency: 100 kHz, Load: 200 Ohm connected via MT-2-200

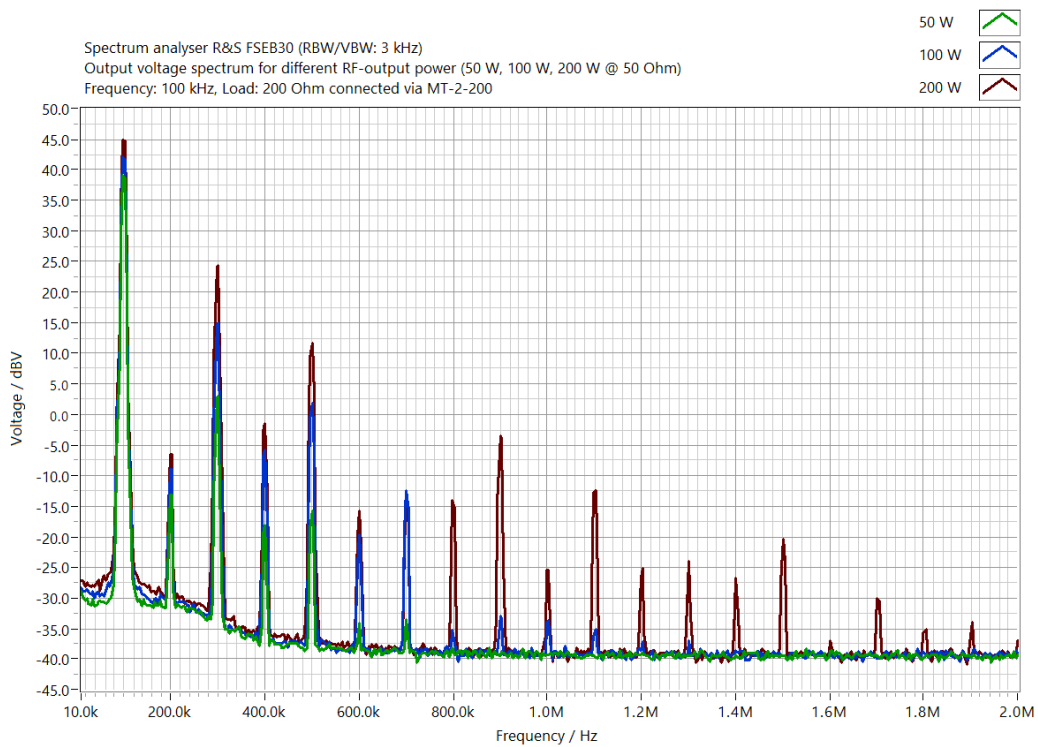





### 6.3.3 Output voltage 1 MHz at 200 $\Omega$

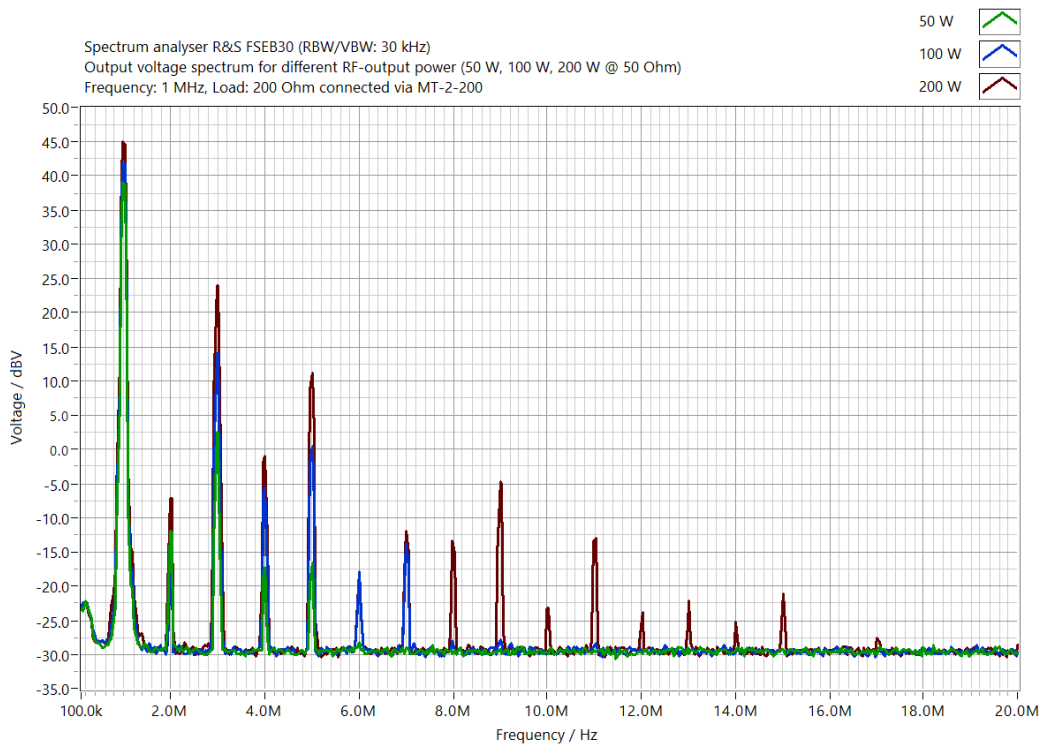

### 6.3.4 Output voltage 10 MHz at 200 $\Omega$

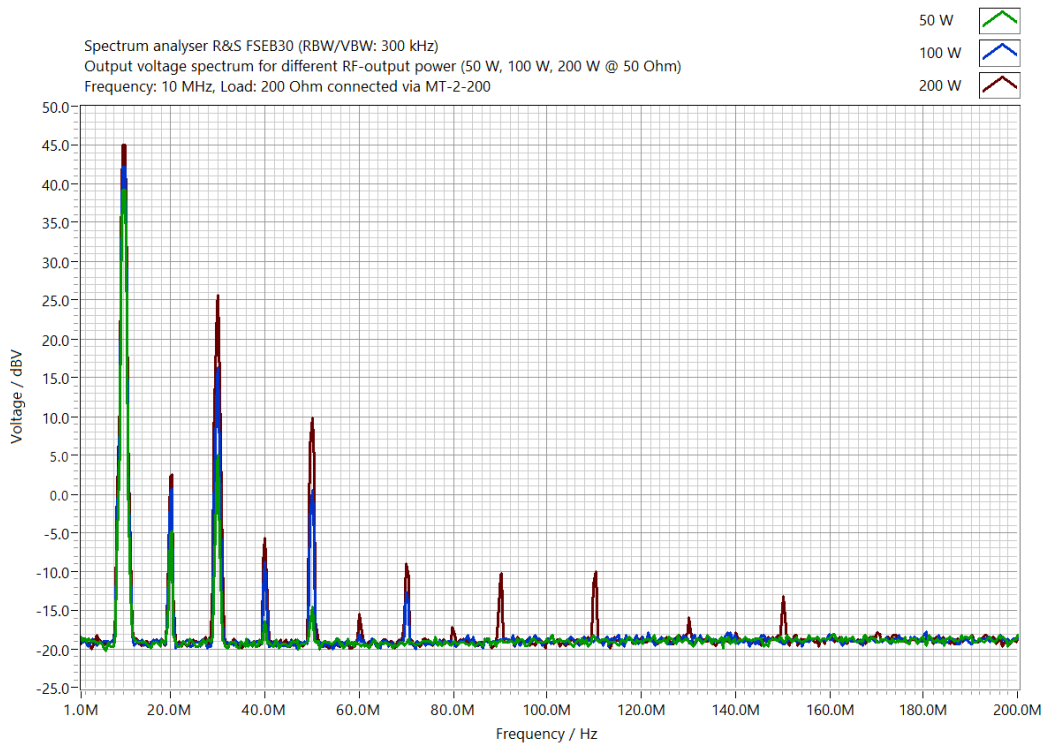



### 6.3.5 Output voltage 50 MHz at 200 Ω

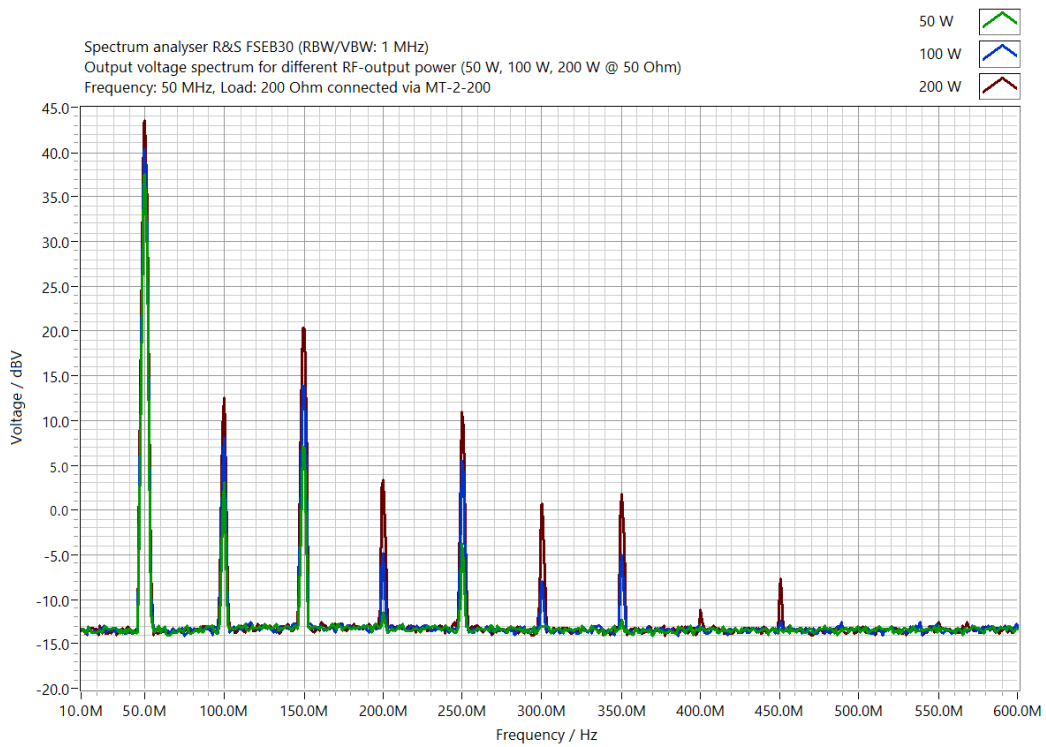

### 6.3.6 Output voltage 100 MHz at 200 Ω

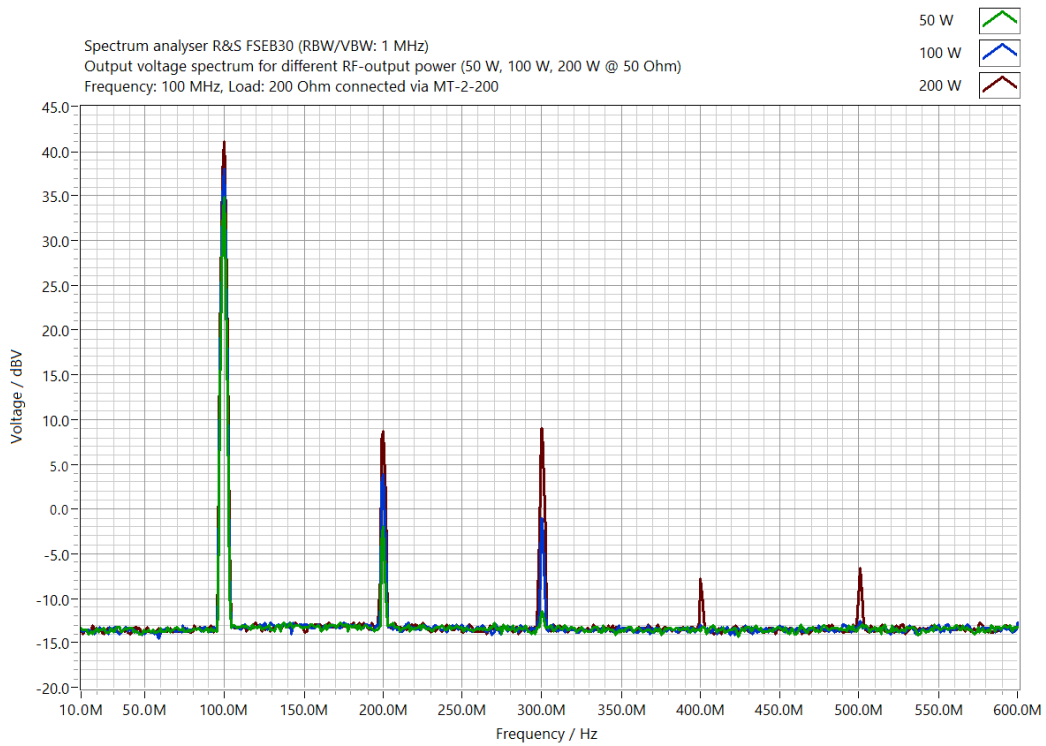



## 7 Contact

**Dr. Hubert GmbH**  
Dietrich-Benking-Str. 41  
44805 Bochum  
Tel. +49 234 970569-0  
Fax. +49 234 970569-29  
service@drhubert.de



Mess- und Prüftechnik. Die Experten.

**Ihr Ansprechpartner /  
Your Partner:**

**dataTec AG**  
E-Mail: [info@datatec.eu](mailto:info@datatec.eu)  
>>> [www.datatec.eu](http://www.datatec.eu)

## 8 Document History

Revision	Date	Changes
1.0	February 2021	First publication