

Data Acquisition System

DAQ-9600

USER MANUAL



dataTec

Mess- und Prüftechnik. Die Experten.

**Ihr Ansprechpartner /
Your Partner:**

dataTec AG

E-Mail: info@datatec.eu

>>> www.datatec.eu



ISO-9001 CERTIFIED MANUFACTURER

GW INSTEK

This manual contains proprietary information, which is protected by copyrights. All rights are reserved. No part of this manual may be photocopied, reproduced or translated to another language without prior written consent of Good Will company.

The information in this manual was correct at the time of printing. However, Good Will continues to improve products and reserves the right to change specifications, equipment, and maintenance procedures at any time without notice.

Good Will Instrument Co., Ltd.

No. 7-1, Jhongsing Rd., Tucheng Dist., New Taipei City 236, Taiwan (R.O.C.).

Table of Contents

SAFETY INSTRUCTIONS	5
Safety Symbols	5
Safety Guidelines	6
GETTING STARTED	9
Characteristics	10
Front Panel Overview	12
Rear Panel Overview	16
Status Bar	18
Set Up	21
MODULE OVERVIEW	23
Modules List	24
Module Slot Cover Removing	25
Module Installation	26
Module Uninstallation	27
Modules Introduction	27
OPERATION MENUS	34
Home Mode	35
Monitor Mode	39
Scan Mode	49
CONFIGURATION MENUS	52
Channel Menu	54
DMM Off for External Device	88
Switch Mode for Channels	90
Computer Channels	92
Interval Menu	96
Edit Menu	99
Alarm Menu	102
View Menu	105
Module Menu	116
Math Menu	118
Average Menu	133
Log Menu	135
DIGITAL I/O	138
Digital I/O Overview	139

Application: Alarm Output	141
Application: External Trigger.....	143
SYSTEM & FIRMWARE	144
View System Info	145
Firmware Update	146
MENU SETTING	148
Configure System.....	149
Configure Display	169
REMOTE CONTROL.....	182
Configure Interface	183
Web Control Interface	210
Command Syntax.....	214
Command Set	217
Status system	337
APPENDIX	342
Fuse Replacement.....	343
Battery Replacement.....	344
Factory Default Parameters.....	346
Specifications	348
DAQ-9600 Section	349
Declaration of Conformity	364
INDEX.....	365

S SAFETY INSTRUCTIONS

This chapter contains important safety instructions that you must follow when operating the DAQ-9600 and when keeping it in storage. Read the following before any operation to insure your safety and to keep the DAQ-9600 in the best possible condition.

Safety Symbols

These safety symbols may appear in this manual or on the DAQ-9600.



WARNING

Warning: Identifies conditions or practices that could result in injury or loss of life.



CAUTION

Caution: Identifies conditions or practices that could result in damage to the DAQ-9600 or to other property.



DANGER High Voltage



Attention Refer to the Manual



Protective Conductor Terminal



Earth (ground) Terminal



Do not dispose electronic equipment as unsorted municipal waste. Please use a separate collection facility or contact the supplier from which this instrument was purchased.

Safety Guidelines

General Guideline • Make sure that the measurement voltage input level does not exceed DC600V/AC400V.



CAUTION

- Do not place any heavy object on the instrument.
- Avoid severe impact or rough handling that can lead to damaging the instrument.
- Do not discharge static electricity to the instrument.
- Use only mating connectors, not bare wires, for the terminals.
- Do not block or obstruct the cooling fan vent opening.
- Do not perform measurement at the source of a low-voltage installation or at building installations (Note below).
- Do not disassemble the instrument unless you are qualified as service personnel.

(Note) EN 61010-2-030 specifies the measurement categories and their requirements as follows.

- Measurement category IV is for measurement performed at the source of low-voltage installation.
- Measurement category III is for measurement performed in the building installation.
- Measurement category II is for measurement performed on the circuits directly connected to the low voltage installation.

-
- Do NOT to use the equipment for measurements on MAINS.
 - Do NOT to use the equipment for measurements on circuits which with a TRANSIENT OVERVOLTAGE over 1500 V.
 - Measuring circuits without a MEASUREMENT CATEGORY: Measuring circuits are not intended to be directly connected to the MAINS.
 - Measurement category of the instrument is rated as without a MEASUREMENT CATEGORY.

The transient overvoltage may be present on the measuring circuits. Refer to the table below for the transient overvoltage on general mains circuits.

Voltage line to neutral derived from nominal voltages AC or DC up to and including	Rated impulse withstand voltage			
	Overvoltage Category			
	I	II	III	IV
V	V	V	V	V
50	330	500	800	1500
100	500	800	1500	2500
150	800	1500	2500	4000
300	1500	2500	4000	6000
600	2500	4000	6000	8000
1000	4000	6000	8000	12000
1250	4000	6000	8000	12000
1500	6000	8000	10000	15000

Power Supply



WARNING

- AC Input voltage: 100/120/220/240 V AC $\pm 10\%$, 50Hz / 60Hz
- The power supply voltage should not fluctuate more than 10%.
- Connect the protective grounding conductor of the AC power cord to an earth ground, to avoid electrical shock.

Power Cord Requirement

If the equipment is used in a manner not specified by the manufacturer, the protection provided by the equipment may be impaired. Do NOT replace the detachable MAINS supply cords by inadequately RATED cords.

Suitable supply cord set for use with the equipment:

- Mains plug: Shall be national approval
- Mains connector: C13 type
- Cable:
 1. Length of power supply cord: less than 3 m
 2. Cross-section of conductors: at least 0.75 mm²
 3. Cord type shall meet the requirements of IEC 60227 or IEC 60245 (e.g.: H05VV-F, H05RN-F)

Fuse



WARNING

- Fuse type: T0.125A 100/120 VAC
T0.125A 220/240 VAC
- Make sure the correct type of fuse is installed before power up.
- To avoid risk of fire, replace the fuse only with the specified type and rating.
- Disconnect the power cord before fuse replacement.
- Make sure the cause of a fuse blowout is fixed before fuse replacement.

Cleaning the Instrument	<ul style="list-style-type: none"> • Disconnect the power cord before cleaning. • Use a soft cloth dampened in a solution of mild detergent and water. Do not spray any liquid into the DAQ-9600. • Do not use chemicals or cleaners containing harsh material such as benzene, toluene, xylene, and acetone.
Operation Environment	<ul style="list-style-type: none"> • Location: Indoor, no direct sunlight, dust free, almost non-conductive pollution (Note below) • Temperature: Full accuracy for 0°C to 55°C. • Humidity: <ul style="list-style-type: none"> < 30°C: < 80%RH (non-condensing) 30°C~40°C: <70%RH (non-condensing) >40°C: <50%RH (non-condensing) • Altitude: <2000m <p>(Note) EN 61010-1 specifies the pollution degrees and their requirements as follows. The DAQ-9600 falls under degree 2. Pollution refers to “addition of foreign matter, solid, liquid, or gaseous (ionized gases), that may produce a reduction of dielectric strength or surface resistivity”.</p> <ul style="list-style-type: none"> • Pollution degree 1: No pollution or only dry, non-conductive pollution occurs. The pollution has no influence. • Pollution degree 2: Normally only non-conductive pollution occurs. Occasionally, however, a temporary conductivity caused by condensation must be expected. • Pollution degree 3: Conductive pollution occurs, or dry, non-conductive pollution occurs which becomes conductive due to condensation which is expected. In such conditions, equipment is normally protected against exposure to direct sunlight, precipitation, and full wind pressure, but neither temperature nor humidity is controlled.
Storage Environment	<ul style="list-style-type: none"> • Location: Indoor • Temperature: -40°C to 70°C • Humidity: <90%RH(non-condensing)
Disposal 	Do not dispose this instrument as unsorted municipal waste. Please use a separate collection facility or contact the supplier from which this instrument was purchased. Please make sure discarded electrical waste is properly recycled to reduce environmental impact.

G E T T I N G S T A R T E D

This chapter describes the DAQ-9600 in a nutshell, including an Overview of its main features and front / rear panel introduction. After going through the Overview, follow the Power-up sequence to properly setup the DAQ-9600.

Please note the information in this manual was correct at the time of printing. However as GW Instek continues to improve its products, changes can occur at any time without notice. Please see the GW Instek website for the latest information and content.

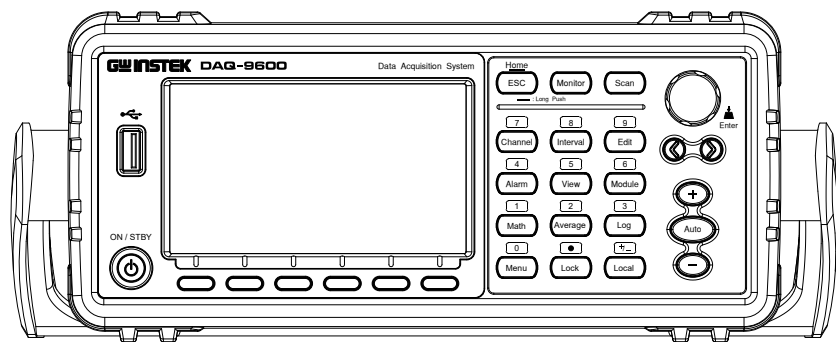

Characteristics	10
Accessories	11
Front Panel Overview	12
Rear Panel Overview.....	16
Status Bar	18
Set Up.....	21
Horizontal/Tilt/Vertical Applications	21
Power Up	22

Characteristics

The DAQ-9600 data acquisition system stands as a modularized solution to offer notable flexibility and high performance level. At its core, the mainframe boasts 3 module slots, while its foundational testing and measurement capabilities are anchored by an integrated precise $6^{1/2}$ digital DMM. To meet varied measurement demands, up to 5 distinct modules are available. Whether engaged in research and development for scrutinizing product characteristics, or system testing and fault diagnosis during production and manufacturing, this system adeptly meets diverse measurement requirements. Through expansion and modification, DAQ-9600 streamlines the overall testing process, rendering a simpler, more efficient and reliable solution.

Performance	<ul style="list-style-type: none"> • The highest DCV accuracy: 35ppm • The highest current: 2A • The highest voltage: 600VDC, 400VAC • The highest ACV frequency response: 300 kHz • The fastest sampling rate: 38.4K Readings /sec • Internal memory: 100k read memory • Data Logging to USB
Features	<ul style="list-style-type: none"> • 3-Slot mainframe with built-in $6^{1/2}$ digit DMM • Multi functions: ACV, DCV, ACI, DCI, 2W/4W R, Hz, Temp, Strain, Diode, Period, Capacitance test, REL, dBm, Hold, MX+B, 1/X, REF%, dB, Compare and Statistics. • Manual or Auto ranging • AC true RMS • Up to 3 temperature measurements: <ul style="list-style-type: none"> • RTD, Thermistor and Thermocouples (Built-in Cold-Junction Compensation) • Graph Display: BarMeter, TrendChart, Histogram
Interface	<ul style="list-style-type: none"> • USB device/LAN for remote control / • GPIB(factory install) • 9-pin Digital I/O port • USB device port supports USBCDC and USBTMC • USB Host
Software	<ul style="list-style-type: none"> • DAQ-Data Logger

Accessories



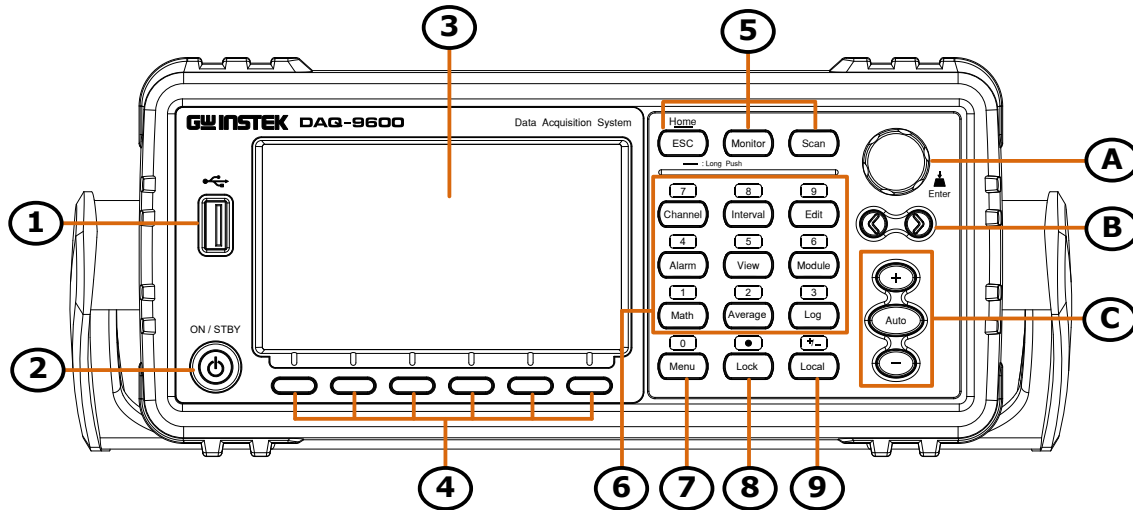

Standard Accessories	Part number	Description
	82xx-xxxxxxx	Safety Instruction Sheet

Optional Accessories	Part number	Description
	GTL-246	USB Cable, USB 2.0, A-B type, 1200mm
	GTL-258	Mini GPIB Cable, approx. 1.9m
	GRA-422	Rack Mount Kit (19" 2U)
	GRA-436	Rack Mount Kit (19", 2U) for two sets

Front Panel Overview





Item	Description
1	USB Host Port
2	Power Switch
3	Main Display
4	Function keys (F1 through F6, functions vary per modes)
5	Operation menus keys for measurement
6	Configuration menus keys for parameters (also the numerical keypad functions)
7	Menu key (also the numerical keypad function)
8	Lock key (also the numerical keypad function)
9	Local key (also the numerical keypad function)
A	Knob key
B	Arrow keys (Speed selection keys)
C	Range keys

<p>USB Host Port</p>		<p>Connects with USB flash drive for data log storage and screenshot hardcopy.</p>
<p>Power Switch</p>		<p>Power On/Standby switch with LED lights (green: power on, red: standby). For the power up sequence, see page 22.</p>
<p>Main Display</p>	<p>The 4.3”TFT LCD shows measurement results and parameters. For display configurations, see page 169.</p>	
<p>Function Keys</p>	<p>The 6 keys have varied functions per different settings.</p>	
<p>Operation menus keys</p>	<p>The 3 operation-related menus keys are well described below.</p>	
<p>Home/ESC key</p>		<p>Single press to escape from current page. Press and hold the ESC key for 2 seconds to return to the Home screen. Refer to page 35 for more details of Home screen.</p>
<p>Monitor key</p>		<p>Single press to activate the Monitor mode in which real-time measured data on a select channel is shown. Refer to the page 39 for details on the Monitor mode. The monitor icon will flash from the status bar when activated.</p>
<p>Scan key</p>		<p>Single press to activate Scan mode in which measurements of all available channels will be proceeded to orderly. Press and hold the key for 2 seconds to exit scan mode. Refer to page 49 for details on Scan mode. The scan icon will be shown from the status bar when activated. In addition, it is available to enable monitor mode on a select channel even though the scan mode is activated.</p>

Configuration menus keys The 9 configuration-related menus keys are well described below.

Channel Key  Press to enter the Channel setting menu for each channel. Refer to the page 54 for details of channel configurations. When inputting parameters values, it acts a direct number key – 7.

Interval Key  Press to enter the Interval setting menu for all channels. Refer to the page 96 for details of interval configurations. When inputting parameters values, it acts a direct number key – 8.





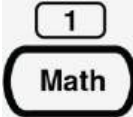

Edit Key  Press to enter the Edit setting menu in which user can copy set parameters from channels to channels. Refer to the page 99 for details of edit configurations. When inputting parameters values, it acts a direct number key – 9.

Alarm Key  Press to enter the Alarm setting menu for each channel. Refer to the page 102 for details of alarm configurations. When inputting parameters values, it acts a direct number key – 4.

View Key  Press to enter the View menu in which the measurement data from scan mode can be viewed in various details. Refer to the page 105 for details of view configurations. When inputting parameters values, it acts a direct number key – 5.

Module Key  Press to enter the Module setting menu in which all channels from each module can be set up in general for either Scan mode or Switch mode. Refer to the page 116 for details of scan and switch modes configurations. When inputting parameters values, it acts a direct number key – 6.

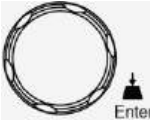
Math Key  Press to enter the Math setting menu for each channel. Refer to the page 118 for details of math configurations. When inputting parameters values, it acts a direct number key – 1.

Average Key		Press to enter the Average setting menu for each channel. Refer to the page 133 for details of average configurations. When inputting parameters values, it acts a direct number key – 2.
Log Key		Press to enter the Log setting menu in which user can store measured data from scan mode or capture screenshot to the USB disk. Refer to the page 135 for details of log configurations. When inputting parameters values, it acts a direct number key – 3.
Menu Key		Press to enter the general Menu setting page for DAQ-9600 unit. Refer to the page 149 for details of menu configurations. When inputting parameters values, it acts a direct number key – 0.
Lock Key		Press and hold for 1 second to lock all keys on panel. Press and hold again to unlock. The lock icon is shown on the status bar when activated. When inputting parameters values, it acts a direct number key – decimal “.”.
Local Key		Press to return to the local operation from remote control mode. When inputting parameters values, it acts a direct number key – “+” and “-”.
Knob Key		Scrolls the knob to select parameters in various setting pages. Press the key until click to confirm setting.
Arrow Keys		Press the left or right arrow keys to move parameter cursor rightward or leftward. Also, it is able to promptly configure Speed setting under Channel menu.
Range Selection Keys		Presses the Auto key to activate auto-range setting, whilst clicking “+” or “-” key can increase or decrease range parameter, respectively under Channel menu. Also, it is available to promptly change among channels in Interval, Alarm, Math and Average menus.

Rear Panel Overview

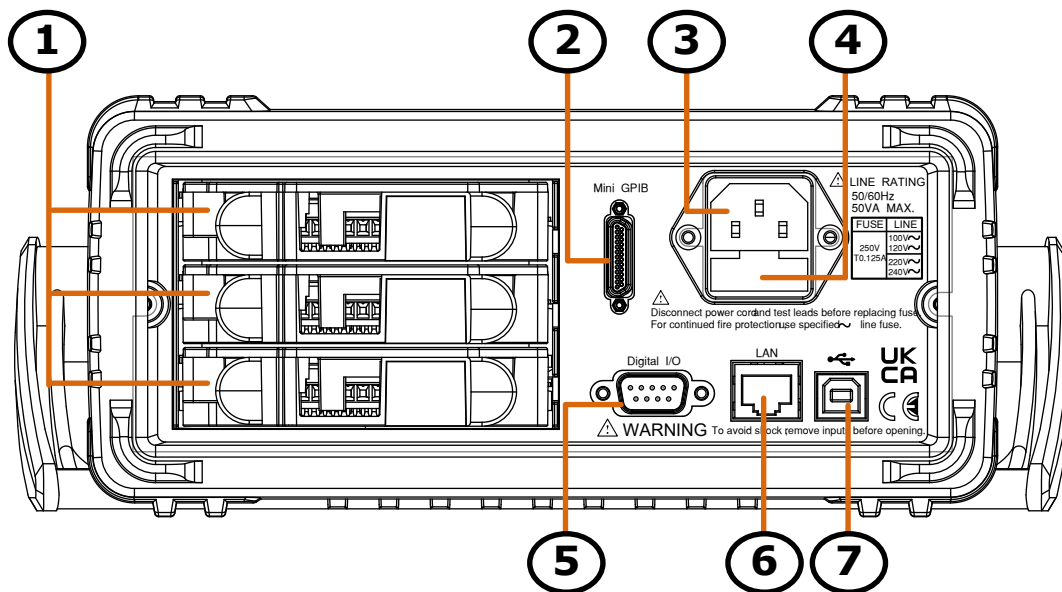

Item	Description
1	Slots for Modules Installation
2	Mini GPIB Connector
3	AC Mains Input (Power Cord Socket)
4	AC Mains Line Voltage Selector and Fuse Socket
5	Digital I/O Connector
6	Ethernet (LAN) Connector
7	USB Interface Connector (B Type)

Slots for Modules Installation

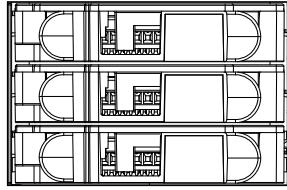

DAQ-9600 provides up to 3 slots for plug-in modules installation. Refer to page 24 for details of Modules.

Mini GPIB Port

Mini GPIB

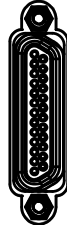

It accepts a mini GPIB cable for remote control. For GPIB details, see page 190.

Power Cord Socket

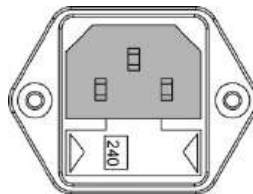

Accepts the power cord. AC 100/120/220/240V $\pm 10\%$, 50Hz / 60Hz $\pm 10\%$.

For power on sequence, see page 22.

Line Voltage Selector and Fuse Socket

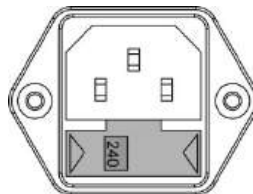

Holds the main fuse:
100/120 VAC: T0.125A
220/240 VAC: T0.125A

For fuse replacement details, see page 343.

Digital I/O Port



It accepts a digital I/O cable for the Hi/Lo limit tests; DB-9 pin, female connector. For digital I/O details, see page 138.

LAN Port

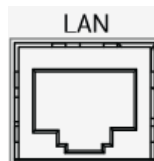

It accepts a LAN cable for remote control. For Ethernet remote control details, see page 193.

USB Interface Port



It accepts a USB device cable for remote control; Type B, female connector. For USB remote control details, see page 184.







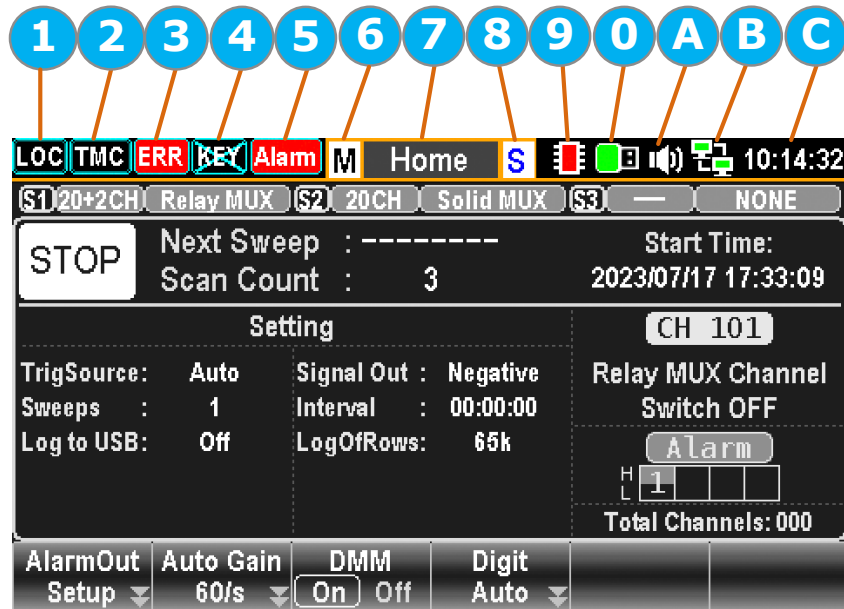



Status Bar













Background Identify each icon within the top status bar.

Status Bar Display



Item	Description
1	Local/Remote control icon
2	USB-CDC/USB-TMC/LAN/GPIB interface icon
3	Error icon for commands from remote control
4	Locked key icon
5	Alarm triggered icon
6	Monitor mode underway icon
7	Configuration menu identifications
8	Scan mode underway icon
9	Internal memory overflowed icon
0	USB disk connection icon
A	Beep/Key Sound setting icon
B	Internet connection status icon
C	Time display

Local Control		It indicates the unit is under local control mode.
Remote Control		It indicates the unit is under remote control. Refer to page 183 for details.
USB - CDC		It indicates USB - CDC interface is activated. Refer to page 189 for details.
USB - TMC		It indicates USB - TMC interface is activated. Refer to page 189 for details.
LAN		It indicates LAN interface is activated. Refer to page 193 for details.
GPIB		It indicates GPIB interface is activated. Refer to page 190 for details.
ERROR		It indicates error occurs in commands. To erase the error icon, it is required to read or sweep the error by remote control commands or reboot action. Refer to page 315 for details.
Lock Key		It indicates all panel keys are locked. Press and hold the Lock key for 1 second to unlock and the icon will disappear.
Alarm icon		It indicates when the set threshold(s) of alarm is triggered. Refer to page 103 for details of alarm configurations. To clear alarm state with icon, go to the Home mode. Refer to page 36 for details.
Monitor mode		It indicates the Monitor mode is ongoing. Press the Monitor key to exit and the icon will disappear. Refer to page 39 for details.
Configuration menu identification		It indicates the unit is under one of the configuration menus including Channel, Interval, Edit, Alarm, View, Module, Math, Average and Log. In addition, the icons of Home screen and Monitor mode are shown here.

Scan mode		It indicates the Scan mode is ongoing. Press and hold the Scan key for 1 second to exit and the icon will disappear. Refer to page 49 for details.
Internal memory overflowed		It indicates the internal memory for scan data has reached 100,000 readings. And therefore the oldest readings will be replaced by the new readings.
Flash Drive – Save Reading		It indicates the USB disk is ready to save log file types including Capture and Scan Data. The “ex” stands for exFat format. The “32” signals fat32 format. and the “16” represents fat16 format.
Flash Drive – Save Log (Capture & Data)		It indicates the unit is saving log including Capture and Scan Data into the USB disk. Refer to the page 135 for details of Capture. And refer to page 136 for details of Scan Data.
Flash Drive – Failure		It indicates something error occurs and thus USB disk fails to connect to unit.
Sound – Beep		It indicates sound of beep is enabled. Refer to page 149 for details.
Sound - Key		It indicates sound of key is enabled. Refer to page 150 for details.
Sound – All		It indicates sounds of beep and key are both enabled.
Sound – Off		It indicates sounds of beep and key are both disabled.
Internet On		It indicates internet connection is established. Refer to page 193 for details.
Internet Off		It indicates internet connection is Not well established.
Time Display		It indicates the time display. For detailed setting, refer to page 152.

Set Up

Horizontal/Tilt/Vertical Applications

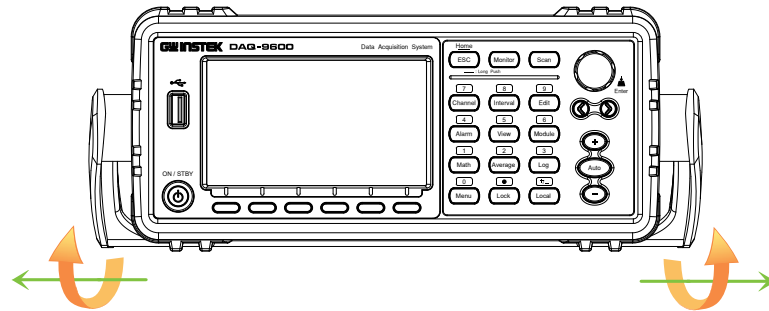

Pull out the handle sideways and rotate it clockwise for the applications below.

Horizontal

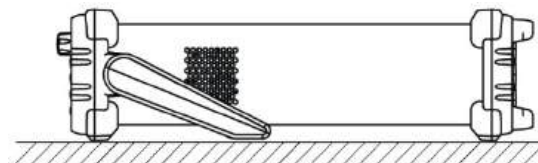

Place the unit horizontally.

Tilt

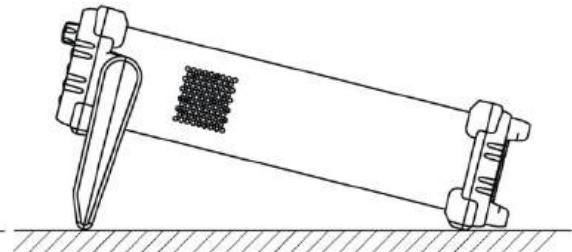

Rotate the handle for tilt stand.

Vertical

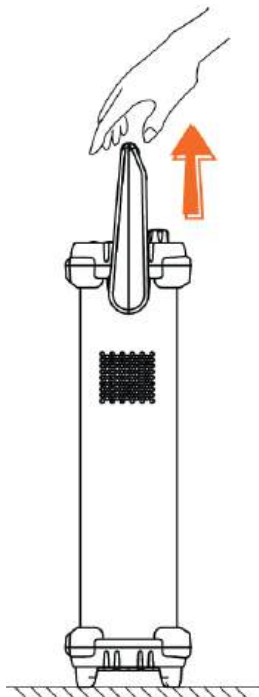

Place the handle vertically for hand carry.

Power Up

Steps

1. Ensure the correct line voltage is clearly shown on the fuse socket (240V in the right figure for example). If not, see page 343 to set the proper line voltage and fuse.

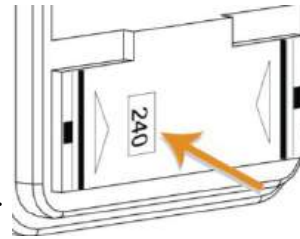

2. Connect the power cord to the AC Voltage input.

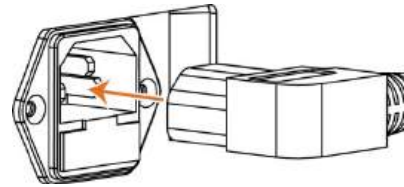

Note

Make sure the ground connector on the power cord is connected to a safety ground. This will affect the measurement accuracy.

3. Push the power button until click to turn on the main power switch on the front panel.

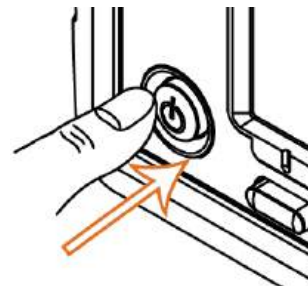

4. The screen firstly shows the logo brand of GWINSTEK followed by the message “Load the Parameter [Last] is Ok” indicating the previous parameter is loaded in the initial startup.

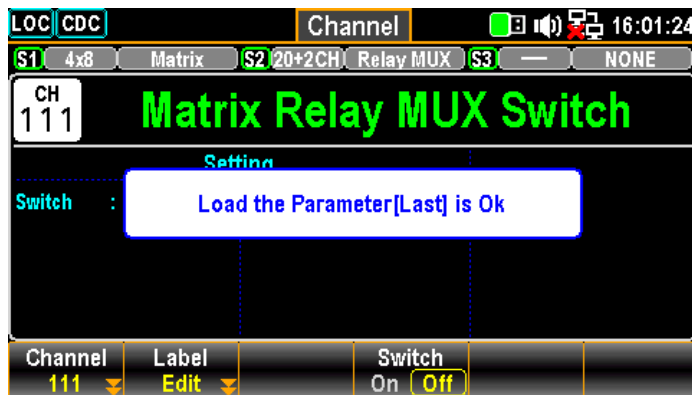

M MODULE OVERVIEW

Modules List	24
Module Slot Cover Removing	25
Module Installation	26
Module Uninstallation.....	27
Modules Introduction.....	27
DAQ-900 20-Channel Solid-State Multiplexer.....	28
DAQ-901 20-Channel Armature Multiplexer	29
DAQ-903 40-Channel Single-Ended Multiplexer	30
DAQ-904 4 x 8 Two-Wire Matrix Switch.....	31
DAQ-909 8-Channel High Voltage Multiplexer	32
DAQ-908 20-Channel Actuator/General Purpose Switch	33

Modules List

Background The DAQ-9600 is available for a series of plug-in modules to provide user with measurements, switching as well as control capabilities. Each module owns specific microprocessor, which efficiently shares loading from the processor of mainframe and thus lessens, in order to faster throughput, backplane communications. There are up to 6 different plug-in modules available for DAQ-9600. See the detailed info with spec below.

- DAQ-900 20-Channel Solid-state multiplexer
- DAQ-901 20-Channel Armature multiplexer
- DAQ-903 40-Channel single-ended multiplexer
- DAQ-904 4 x 8 Two-wire matrix switch
- DAQ-909 8-Channel high voltage multiplexer
- DAQ-908 20-Channel Actuator/General Purpose Switch

Model description	Type	Speed (ch/sec)	Max volts	Max amps	Bandwidth	Thermal offset	Comments
DAQ-900 20 ch Multiplexer	2-wire solid-state (4-wire selectable)	450	120 V		10 MHz	< 4 μ V	Built-in cold junction reference
DAQ-901 20 ch Multiplexer + 2 current channels	2-wire armature (4-wire selectable)	80	300 V	1 A	10 MHz	< 4 μ V	Built-in cold junction reference 2 additional current channels (22 total)
DAQ-903 40 ch Single-Ended Mux	1-wire armature (common low)	80	300 V		10 MHz	< 1 μ V	No four-wire measurements
DAQ-904 4 x 8 Matrix	2-wire armature		300 V		10 MHz	< 1 μ V	
DAQ-909 8 ch HV Multiplexer + 2 current channels	2-wire armature (4-wire selectable)	60	DC600 V AC400V	2 A	10 MHz	< 4 μ V	2 additional current channels (10 total)
DAQ-908 20-channel Actuator/General Purpose Switch	SPDT/from C		300 V		10 MHz	< 4 μ V	

Module Slot Cover Removing

Background Prior to module installation, follow the steps below for how to remove a module slot cover from DAQ-9600 unit.

Steps

1. First release inner hook by pressing on curve area from either right or left side on slot cover. Use finger to subtly shake the curve area so as to make inner hook unleashed from DAQ-9600 unit.

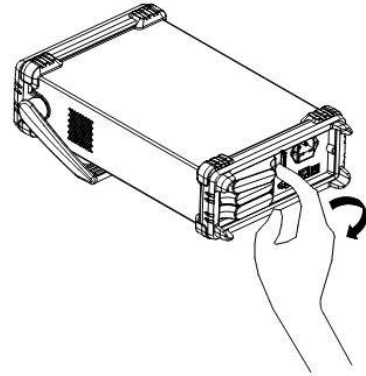

2. Use 2 fingers to grip curve areas of both right and left sides on slot cover and gently pull outward so as to remove slot cover from DAQ-9600 unit.

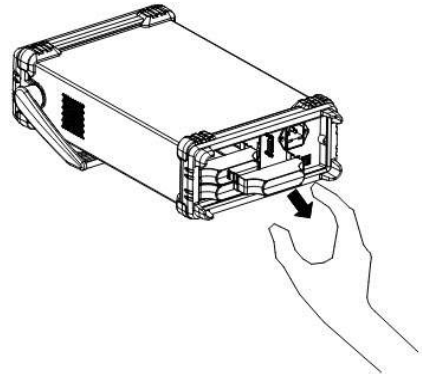

Note

Press and shake curve area from either right or left side alternately when it is difficult to release inner hook in one side.

Module Installation

Background Follow the steps below for how to connect wire to a module and install it to a slot from the rear panel of DAQ-9600 unit.



Note

It is recommended to utilize wire size ranging from 16 gauge to 22 gauge for screw terminals on the module.

Steps

1. Use a Phillips-head screwdriver to loose the screw from the top of a module followed by taking away the upper cover from module.

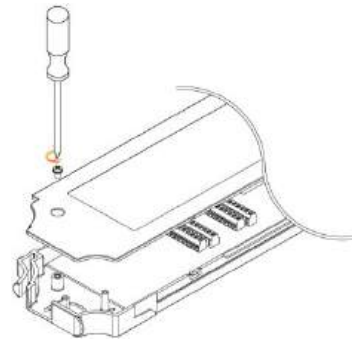

2. With help of a Phillips-head screwdriver, connect the wire to the terminal followed by routing the wire to the end port of module.

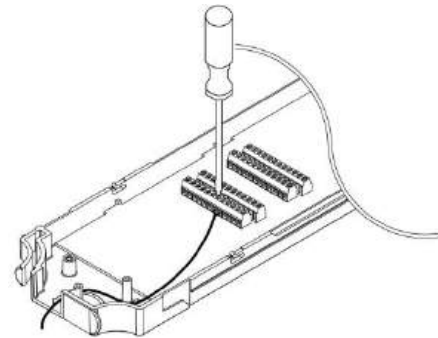

3. Restore the upper cover back to the module followed by fastening the screw by a Phillips-head screwdriver.

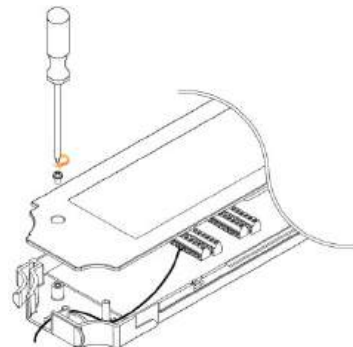

4. Insert the module into one of the module slots from the rear panel of DAQ-9600 unit.

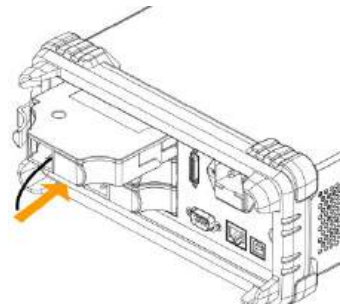

Module Uninstallation

Background Follow the step below for how to uninstall a module out of a slot on rear panel of DAQ-9600 unit.

Step

1. First push inward the clip at the rear-left corner of a module followed by pulling module out from a slot on rear panel of DAQ-9600 unit.

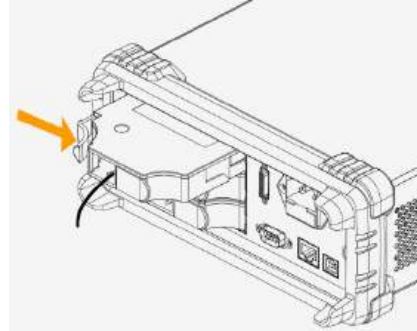

Note

To install/uninstall the modules from the slots of rear panel in the midst of power on will reboot the DAQ-9600 unit.

Modules Introduction

Background This subchapter introduces each plug-in module with block diagram and schematics available for DAQ-9600 unit.



Note

- **DO NOT MEASURE MORE THAN THE RATED VOLTAGE.**
Maximum voltage as marked on each module is as below:
 - 1) DAQ-900: 120 Vrms
 - 2) DAQ-901, DAQ-903, DAQ-904, DAQ-908: 300 Vrms
 - 3) DAQ-909: 600 Vdc/400Vrms
- **Limitations on measurement input terminals of all modules.**
 - 1) Sense LO to Input LO terminals are limited to 2Vpk for all modules. (DAQ-900, DAQ-901, DAQ-903 and DAQ-909)
 - 2) Sense HI to Sense LO terminals are limited to 200Vpk for DAQ-901 and DAQ-903. Sense HI to Sense LO terminals are limited to 100Vpk for DAQ-900.
 - 3) Input LO to Earth ground are limited to 500Vpk for DAQ-901 and DAQ-903. Input LO to Earth ground are limited to 200Vpk for DAQ-900.

DAQ-900 20-Channel Solid-State Multiplexer

Background Partitioned into 2 banks and each bank consists of 10 two-wire channels, this module has up to 20 channels, which switch both Hi and Lo inputs, and it offers fully isolated inputs to an external device or to the internal DMM. Channels of bank A are paired with channels of bank B automatically, in the midst of four-wire resistance measurements, to offer the source and sense connections. In addition, this module can minimize errors, which result from thermal gradients when measurement, by the built-in thermocouple reference junction.

Block Diagram

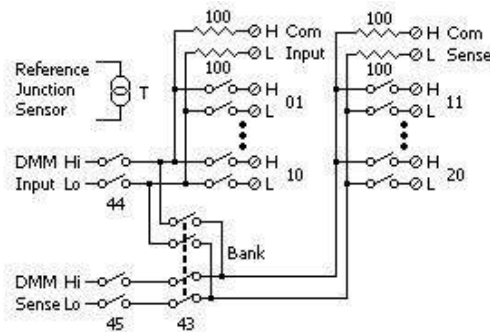

! Note

- Always utilize only wire which is rated for the highest voltage so as to avoid electrical shock. Prior to removing a cover of module, all power to external devices which are connected to the module should be turned off.
- It is strongly suggested that when multiplexing multiple sources, in order to prevent multiple signal sources from interconnected one another, the sources are supposed to be connected on separate banks of the identical module or simply on separate modules.
- When a hazardous voltage source is connected to any channel of the module, both the unit and DUT (Device Under Test) are supposed to be supervised with conforming to the local EHS (Environment, Health and Safety) practices.
- For the measurement of 100 Ω and 1 k Ω resistance ranges, it is recommended to use 4-wire resistance.

DAQ-901 20-Channel Armature Multiplexer

Background Partitioned into 2 banks and each bank consists of 10 two-wire channels, this module has two additional fused channels to make direct and calibrated AC or DC current measurement with internal DMM. The 22 channels in total, which switch both Hi and Lo inputs, offer fully isolated inputs to an external device or to the internal DMM. Channels of bank A are paired with channels of bank B automatically, in the midst of four-wire resistance measurements, to offer the source and sense connections. In addition, this module can minimize errors, which result from thermal gradients when measurement, by the built-in thermocouple reference junction.

Block Diagram

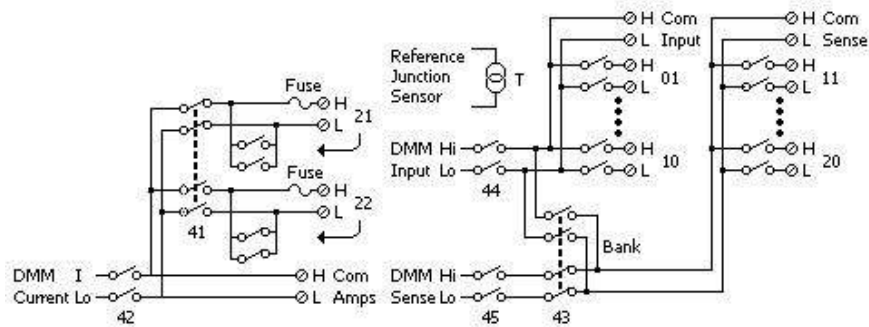

! Note

- Because one of the two channels (21 and 22) will be closed when the other one is connected, be sure to connect one of the channels (21 or 22) to the internal DMM or COM at a time.
- Always utilize only wire which is rated for the highest voltage so as to avoid electrical shock. Prior to removing a cover of module, all power to external devices which are connected to the module should be turned off.
- It is strongly suggested that when multiplexing multiple sources, in order to prevent multiple signal sources from interconnected one another, the sources are supposed to be connected on separate banks of the identical module or simply on separate modules.
- When a hazardous voltage source is connected to any channel of the module, both the unit and DUT (Device Under Test) are supposed to be supervised with conforming to the local EHS (Environment, Health and Safety) practices.

DAQ-903 40-Channel Single-Ended Multiplexer

Background This module is partitioned into 2 banks and each bank consists of 20 channels. The all 40 channels, with a common Lo for the module, switch Hi only. This module is suitable for applications of high-density switching which are in demand of, with a common Lo, single-wire inputs.

Block Diagram

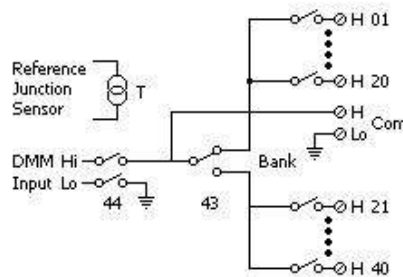

! Note

- This module is not allowed to measure 4-wire or current measurements directly.
- One channel can be closed at one time only, and shutting a channel will thus open the formerly closed channel.
- Always utilize only wire which is rated for the highest voltage so as to avoid electrical shock. Prior to removing a cover of module, all power to external devices which are connected to the module should be turned off.
- It is strongly suggested that when multiplexing multiple sources, in order to prevent multiple signal sources from interconnected one another, the sources are supposed to be connected on separate banks of the identical module or simply on separate modules.
- When a hazardous voltage source is connected to any channel of the module, both the unit and DUT (Device Under Test) are supposed to be supervised with conforming to the local EHS (Environment, Health and Safety) practices.

DAQ-904 4 x 8 Two-Wire Matrix Switch

Background Organized in a 8-column by 4-row configuration, this module consists of 32 two-wire crosspoints. By connecting columns and rows between multiple modules, it is available to build larger matrices with up to 96 crosspoints within a mainframe. Also, user can utilize this module to connect to multiple instruments to multiple points or to any hybrid of outputs and inputs on DUT simultaneously. Since this module is not allowed to connect to the internal DMM, each relay of crosspoint owns an unique channel label which represents the column and row. Take the diagram below for instance, the channels 32 stands for the crosspoint between the row 3 and column 2.

Block Diagram

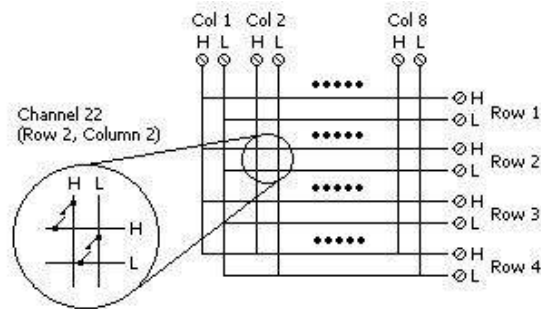

! Note

- It is available to close multiple channels on this module simultaneously.
- Always utilize only wire which is rated for the highest voltage so as to avoid electrical shock. Prior to removing a cover of module, all power to external devices which are connected to the module should be turned off.
- It is strongly suggested that when multiplexing multiple sources, in order to prevent multiple signal sources from interconnected one another, the sources are supposed to be connected on separate banks of the identical module or simply on separate modules.
- When a hazardous voltage source is connected to any channel of the module, both the unit and DUT (Device Under Test) are supposed to be supervised with conforming to the local EHS (Environment, Health and Safety) practices.

DAQ-909 8-Channel High Voltage Multiplexer

Background Partitioned into 2 banks and each bank consists of 4 two-wire channels, this module has two additional fused channels to make direct and calibrated AC or DC current measurement with internal DMM. The 10 channels in total, which switch both Hi and Lo inputs, offer fully isolated inputs to an external device or to the internal DMM. Channels of bank A are paired with channels of bank B automatically, in the midst of four-wire resistance measurements, to offer the source and sense connections.

Block Diagram

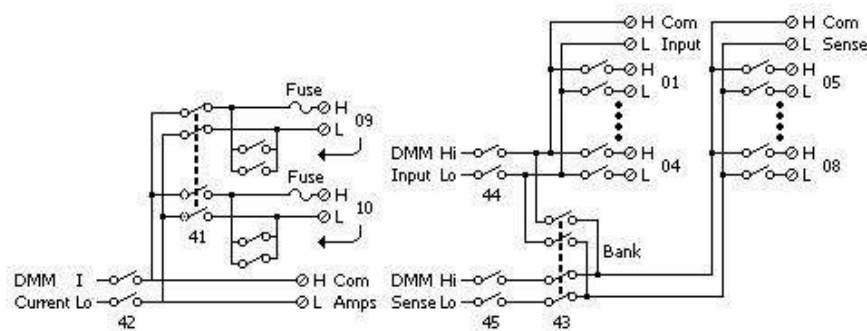

Note

- Because one of the two channels (09 and 10) will be closed when the other one is connected, be sure to connect one of the channels (09 or 10) to the internal DMM or COM at a time.
- It is required to utilize external parallel resistor when executing current measurement from channel 01 to 10.
- Always utilize only wire which is rated for the highest voltage so as to avoid electrical shock. Prior to removing a cover of module, all power to external devices which are connected to the module should be turned off.
- It is strongly suggested that when multiplexing multiple sources, in order to prevent multiple signal sources from interconnected one another, the sources are supposed to be connected on separate banks of the identical module or simply on separate modules.
- When a hazardous voltage source is connected to any channel of the module, both the unit and DUT (Device Under Test) are supposed to be supervised with conforming to the local EHS (Environment, Health and Safety) practices.

DAQ-908 20-Channel Actuator/General Purpose Switch

Background This module features 20 independent Single-Pole Double-Throw (SPDT) latching relays, also known as Form C relays. Each relay can switch up to 300 V and 1 A, with a maximum switching power of 50 W. The module is equipped with screw terminals that provide access to the Normally-Open, Normally-Closed, and Common contacts for each of the 20 relays. It is designed to interface with your Device Under Test (DUT) or to actuate external devices but does not connect to the internal Digital Multimeter (DMM). This module is ideal for applications demanding high-integrity contacts or reliable connections for non-multiplexed signals.

- 300 V, 1 A actuation and control
- SPDT (Form C) latching relays

Block Diagram

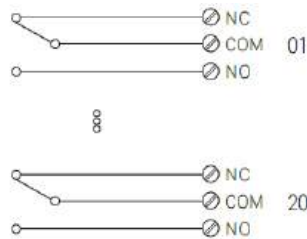

- This module allows for the simultaneous closure of multiple channels. The channel CLOSE and OPEN commands manage the state of the Normally Open (NO) to Common (COM) connection for each channel. For instance, issuing the command CLOSE 201 will connect the Normally Open contact to the Common contact on channel 01.
- Always utilize only wire which is rated for the highest voltage so as to avoid electrical shock. Prior to removing a cover of module, all power to external devices which are connected to the module should be turned off.
- It is strongly suggested that when multiplexing multiple sources, in order to prevent multiple signal sources from interconnected one another, the sources are supposed to be connected on separate banks of the identical module or simply on separate modules.
- When a hazardous voltage source is connected to any channel of the module, both the unit and DUT (Device Under Test) are supposed to be supervised with conforming to the local EHS (Environment, Health and Safety) practices.

OPERATION MENUS

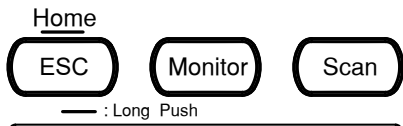

Home Mode 35

Monitor Mode 39

 Display - Number 40

 Display – Bar Meter 41

 Display – Trend Chart 42

 Display – Histogram 46

Scan Mode 49

 Scan Mode with Monitor Mode simultaneously 51

Home Mode

Background Press and hold the *Home* key on the front panel for 1 second to enter the Home menu in which several basic settings are displayed. Refer to the diagram below for details.

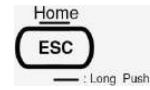

Home Menu Diagram

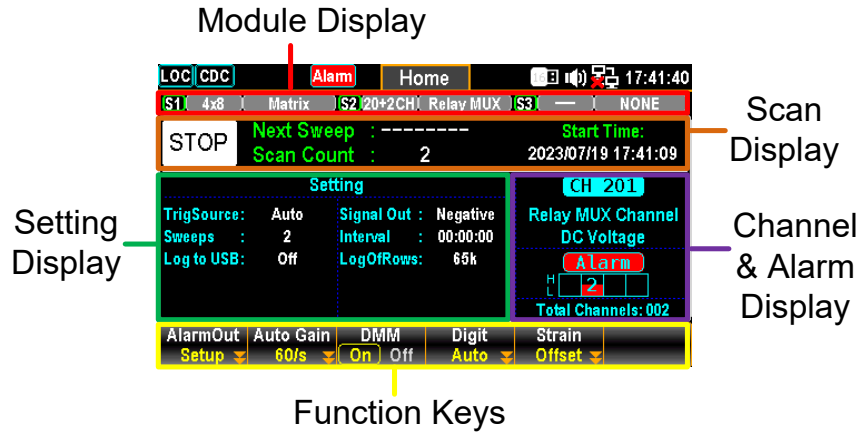

Module Display It includes module slot number and module name as well as total channels of each module. Up to 3 installed modules can be displayed.

Scan Display The status of Scan mode relevant info. Refer to page 136 for details of the Scan menu.

Channel & Alarm Display The upper indicates current channel number and module name with measure type info. Use *knob* key or *arrow* keys to navigate channels. The lower indicates alarm related info in which up to 4 alarms are displayed in red if triggered. And the triggered alarm of Hi and Low limits are shown in half by each (upper half & lower half) for every alarm outputs. Also, the total activated channels number is read below within this section.

Setting Display Few basic settings including “Interval” (page 96) and “Log” (page 135) are displayed here.

Function Keys The operable function keys are available for user to configure several functions. Refer to the following section for more details.



F1 (AlarmOut) key to set up alarm mode relevant settings

Alarm Mode

- Latch: The triggered alarm output is remained unit user clear the alarm manually.
- Track: The triggered alarm output is automatically cleared when a measured reading is within limits.

Alarm Out

- Pos: All 4 alarm output lines are configured to indicate alarm at 3.3 V.
- Neg: All 4 alarm output lines are configured to indicate alarm at 0 V.

Alarm Clear

- Alarm1 ~ 4: Clears alarm state of a selected alarm output line.
- All: Clears alarm states of all 4 alarm output lines.



F2 (Auto Gain) key to specify the gain value for Scan mode

When executing the Scan mode consisting of groups of sweeps covering multiple channels for an extended period of time, it is suggested to activate the Auto Gain feature in an attempt to regain the relative value of reference voltage, which is way vulnerable to be affected by long-term scan measurement. By activating this feature, the total scan time will be subtly extended depending on the selected speed option due to an additional Auto Gain action performed prior to initiation of each sweep.



F3 (DMM) key to enable or disable internal DMM function

Basically, DAQ-9600 is equipped with the internal DMM function which allows up to 3 modules with several channels to measure the connected different DUTs. However, in accordance with specific applications, user may need to connect with external DMM for measurement, while preserving the function of multiple modules connectivity with DUTs provided by DAQ-9600 simultaneously. In this case, turn Off the DMM function and thus DAQ-9600 simply acts as a multiple channels switch hub and reroutes signals received from connected DUTs to the external DMM for measurement. When disabling DMM function, the internal DMM is off and therefore the icon “” appears in the upper status bar. Also, the available options for Measure setting of each channel will be limited. Refer to the page 87 through page 88 for details.

DMM Selection 

F4 (Digit) key to define the maximum digit numbers for measurement

Auto The maximum digit numbers vary by the applied measuring functions and refresh rates automatically.

6 1/2 The maximum digit numbers is fixed in 6 1/2 display.



5 1/2 The maximum digit numbers is fixed in 5 1/2 display.



4 1/2 The maximum digit numbers is fixed in 4 1/2 display.



Digit Selection 

F5 (Strain) key to set up Offset value for Strain measurement

If user configures channel(s) for strain measurement, Strain Offset is available for calculating strain measurement.

Select Press to launch strain channel list where available channel(s) set in strain measure are shown for select. Use *knob* key to navigate channels followed by pressing *Select* or *Select All* to confirm channels. Press *Cancel* or *Clear All* to deselect channels. Press *OK* to confirm selection. Press *Exit* to leave the page without saving the selection.



Get Offset

Press to get offset value(s) for selected channel(s) immediately. The offset values are displayed for each selected channel accordingly.

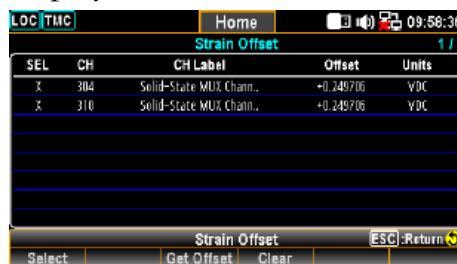

Clear

Press to clear the offset value(s) of selected channel(s). The offset value(s) on the list are returned to 0 instantly after execution.



Strain Offset Selection



Monitor Mode

Background

Press the *Monitor* key on the front panel to launch the monitor function to see real-time measured reading on a select channel. When the Scan mode is activated with Monitor mode simultaneously, the measured reading on a select channel is updated only when the select channel being scanned by a sweep within a scan course. Press the *Monitor* key again to exit monitor mode. Refer to the diagram below for details.



Monitor Menu Diagram

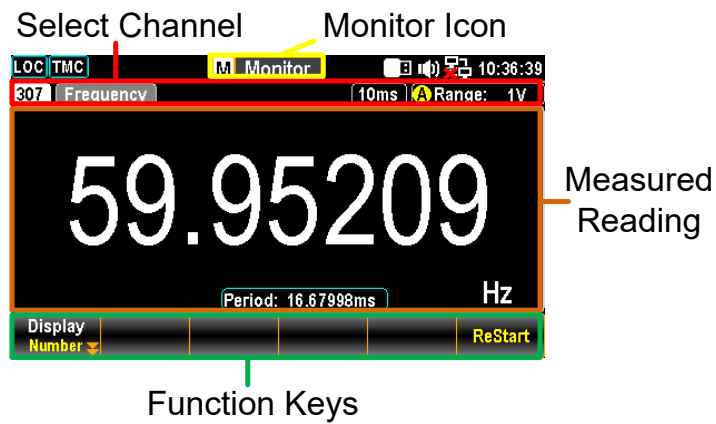

Monitor Icon The status icon along with menu identification indicates the Monitor mode is underway.

Select Channel Use *knob* or *arrow* keys to navigate channels. The select channel number along with affiliated configurations are displayed here.

Measured Reading The real-time measured reading of select channel is shown within this section.

Function Keys The operable function keys are available for user to configure several Display modes. Refer to the following subchapters for more details.

Display - Number

Function Keys
in Display –
Number



F1 (Display) key Number
to enter Number
display

The screen shows the Number mode for reading display. And the maximum digits for number display depend on the Digit configuration.

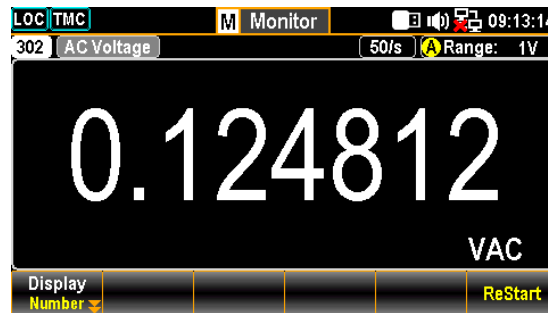

- Restart:

Identical to the Restart key in trend chart and histogram, it is particularly available for Number display when STAT of MathDisp is activated. The relevant STAT values will be remeasured once user presses the *Restart* key. Refer to page 118 for details of STAT in Math chapter.

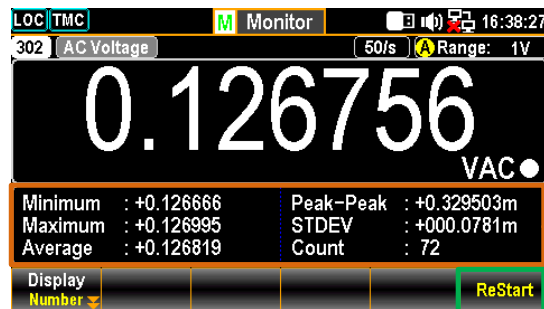

STAT
relevant
values

ReStart key

Display – Bar Meter

Function Keys
in Display –
Bar Meter



F1 (Display) key
to enter Bar
Meter display

The screen shows Bar Meter display in lower section along with Number display in top for reading display. And the maximum digits for Number display depend on the Digit configuration.

- Scale - Normal:
It allows the scale of bar meter to be symmetric with the selected range of measurement.

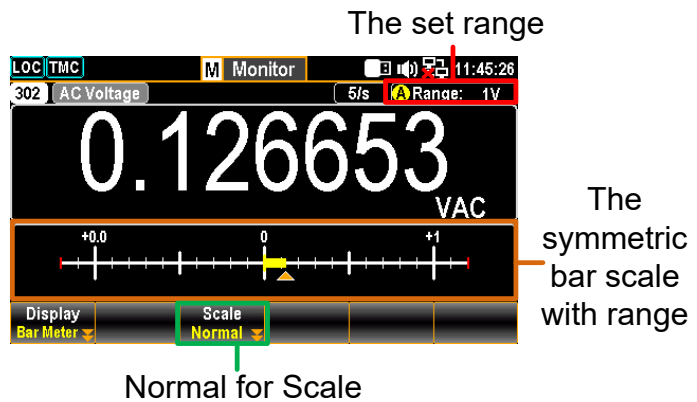

- Scale - Manual:
It allows the scale of bar meter to be customized in varied range of scale.

LowHigh for Method

When LowHigh is selected, it is available to further determine the exact scales for both the high and low ends on the bar meter display.

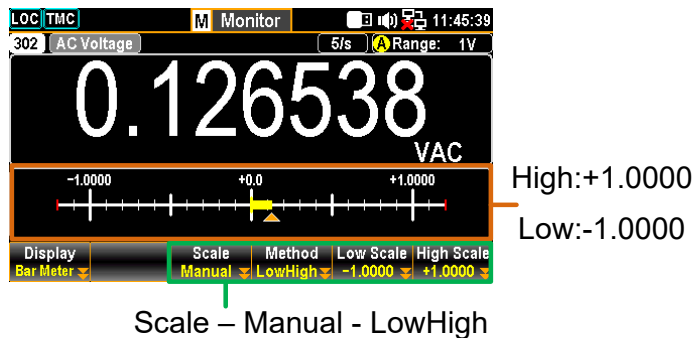

Center for Method

When Center is selected, it is available to further determine the exact Center value and the Span Scale for the meter bar display.

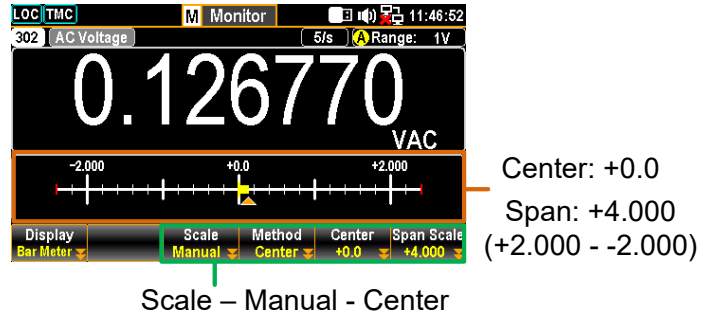

Display – Trend Chart

Function Keys
in Display –
Trend Chart



F1 (Display) key to enter Trend Chart display

The screen shows Trend Chart display in lower along with Number display in top for reading display. And the maximum digits for Number display depend on the Digit configuration.

- VScale - Normal:
It allows the vertical scale of trend chart to be symmetric with set range of measurement.

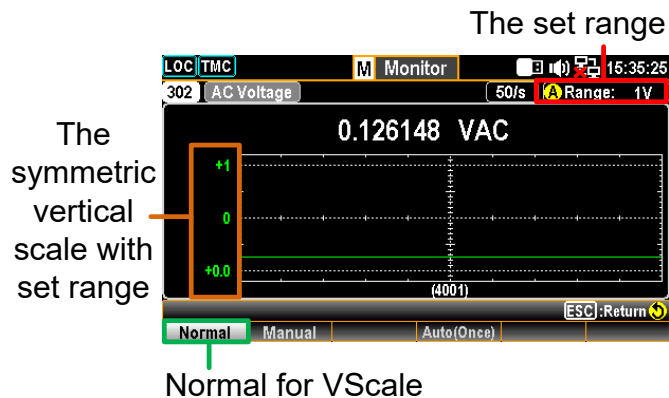

- VScale - Manual:
It allows the vertical scale of trend chart to be customized in varied range.

L & H for Manual

After L and H are set up individually, the vertical upper and lower ranges are corresponding to the set values accordingly.

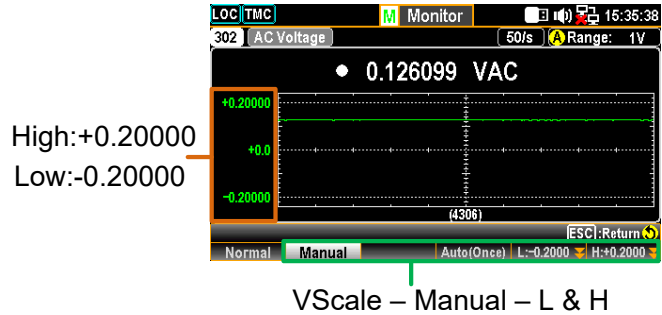

Auto(Once) for Manual

After Auto(Once) is pressed, the vertical upper and lower ranges are automatically defined in accord with the latest 400 counts of measurement from the trend chart.

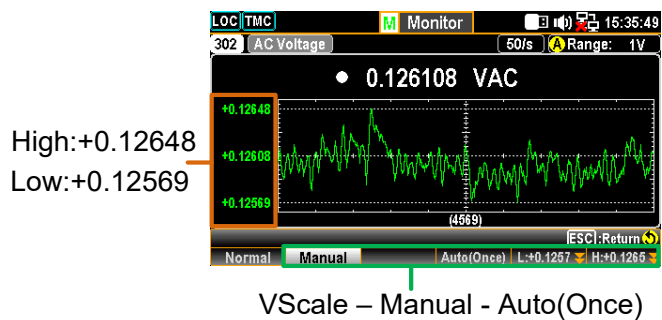

- HScale - Count:**
The horizontal scale of trend chart is symmetric with the set speed of measurement. For example, setting 50/s results in a faster horizontal trend speed, whilst 1/s leads to a slower horizontal trend speed.

- Stop&View - Range:
 Press *Stop&View* key to stop measurement and view detailed info on the trend chart. Press *Range* key followed by scrolling *Knob* key rightward or leftward to move cursors on different sections.

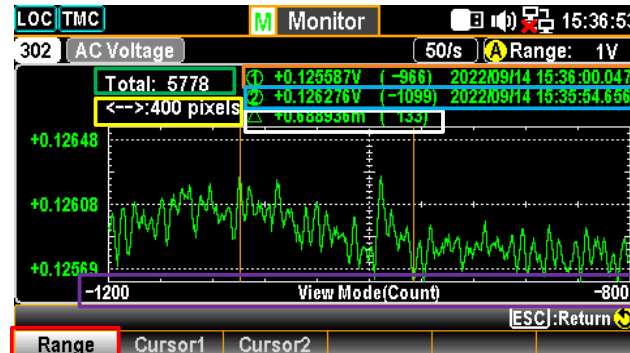

- Green Sect. The total counts of measurements before entering the Stop&View.
- Yellow Sect. Press the *Knob* key to change the maximum counts moving by scrolling *knob* key per time.
 1 pixel – 40 pixels – 400 pixels
- Orange Sect. The lowest value of the selected count with its affiliated serial number and time stamp.
- Blue Sect. The highest value of the selected count with its affiliated serial number and time stamp.
- White Sect. The delta between the highest and lowest values of the selected count with its affiliated serial number.
- Purple Sect. The horizontal scale of measurements displayed is fixed in the 400 counts
- Red Sect. It indicates the counts of moving range by scrolling *Knob* key rightward or leftward to different section per time. Based on the Yellow Sect., when 400 pixels is defined, scroll the *Knob* key once, the scale increases or decreases 400 counts per time.

- Stop&View – Cursor 1 & Cursor 2:
Press *Stop&View* key to stop measurement and view the lowest and highest values of each count on the trend chart. Scroll *Knob* key rightward or leftward to move cursors on different sections.

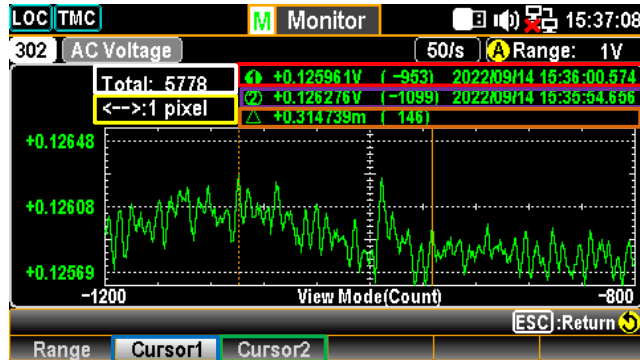

- White Sect. The total counts of measurements before entering the Stop&View.
- Green Sect. Press the *Cursor1* for checking the lowest value of each count.
- Blue Sect. Press the *Cursor2* for checking the highest value of each count.
- Red Sect. The lowest value of the selected count with its affiliated serial number and time stamp.
- Purple Sect. The highest value of the selected count with its affiliated serial number and time stamp.
- Yellow Sect. Press the *Knob* key to change the maximum counts moving by scrolling *knob* key per time.
1 pixel – 10 pixels – 20 pixels
- Orange Sect. The delta between the highest and lowest values of the selected count with its affiliated serial number.

- Start/Restart:
After entering the Stop&View, the measured reading in trend chart is suspended. Press the *Start* key to restart reading in trend chart.

Display – Histogram

Function Keys
in Display –
Histogram



F1 (Display) key
to enter
Histogram
display

Histogram

The screen shows the Histogram display in lower along with Number display in top for reading display. And the maximum digits for Number display depend on the Digit configuration.

- Bins - 100:
Up to 100 strip-like bins, which represents the measured counts, can be seen in histogram display.

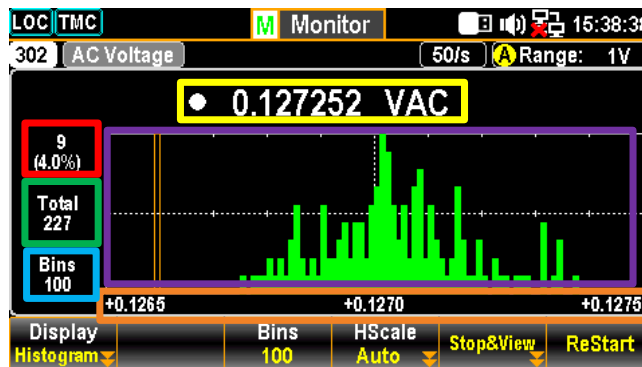

- Green Sect. It indicates the total measured bins accumulated currently.
- Red Sect. It indicates bins of the highest section of measured values with its affiliated percentage from the total counts of measurements.
- Yellow Sect. The currently measured reading in number mode.
- Purple Sect. The histogram display for the measured bins. Up to the 100 latest bins can be shown concurrently.
- Blue Sect. The maximum bin numbers displayed within the purple section.
- Orange Sect. The range of horizontal scale of histogram display.

- Hscale - Auto:**
 The horizontal scale of histogram is symmetric with the set speed of measurement. For example, setting 50/s results in a faster horizontal histogram speed, whilst 1/s leads to a slower horizontal histogram speed.

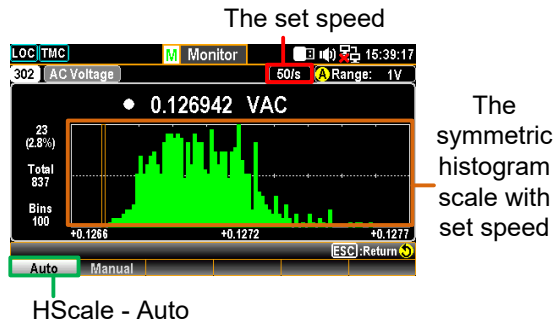

- HScale - Manual:**
 It allows the horizontal scale of histogram to be customized in varied sections.

L & H for Manual

After *L* and *H* are set up individually, the horizontal left and right scales are corresponding to the set *L* and *H* values accordingly.

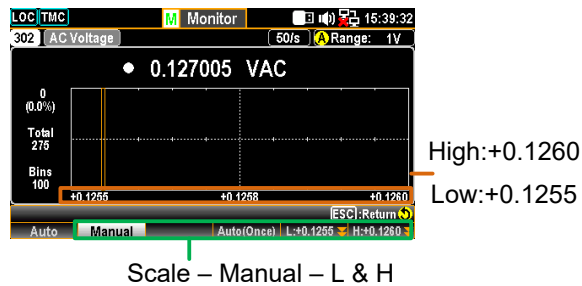

Auto(Once) for Manual

After *Auto(Once)* is pressed, the horizontal left and right scales are automatically defined in accord with the latest bins of measurement from the histogram.

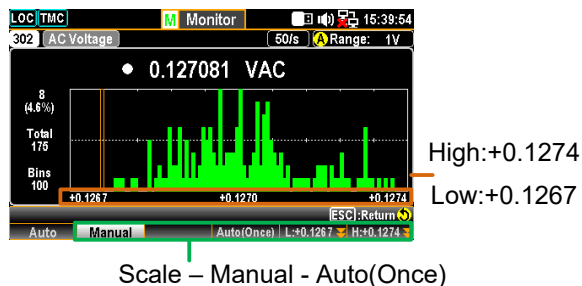

- Stop&View - Class:
 Press *Stop&View* key to stop measurement and view detailed info on the histogram. Scroll the *Knob* key rightward or leftward to move cursors on different bins.

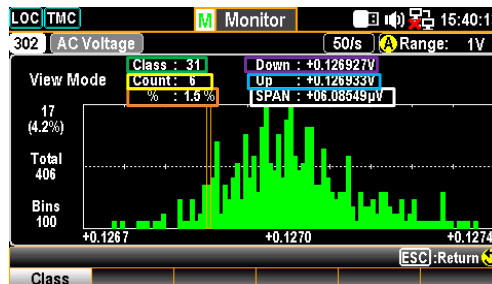

- Green Sect. It indicates the selected bin number.

Yellow Sect. It indicates the total accumulated counts of measurement.

Orange Sect. It indicates the exact percentage of the total counts of measurement from the selected bin number.

Purple Sect. It indicates the lowest value being measured within the selected bin number.

Blue Sect. It indicates the highest value being measured within the selected bin number.

White Sect. It indicates the difference in value between the highest and lowest values.

- Start/Restart:
 After entering the Stop&View, the measured reading in histogram is suspended. Press the *Start* key to restart reading in histogram.

Scan Mode

Background

Press the *Scan* key on the front panel to initiate the scan function. During a scan course, DAQ-9600 scans available channels whose measurement functions are configured previously. Also, the Computer channels (401-420), whose computed formula are configured previously, will be scanned by DAQ-9600 in a scan course as well. Refer to page 92 for details of Computer channels.



For those channels whose measurement functions are Not configured previously, the Scan mode will skip them from a scan course. DAQ-9600 scans available channels from slot 1 to slot 3 followed by Computer channels (401-420). A scan course consists of user-defined sweep(s) and a sweep indicates one pass through the available channels.

There are up to 100,000 readings data with time stamp stored in memory during a scan course. All readings data from the previous scan course will be cleared automatically in memory once user starts a new scan course.

In order to stop a scan course, press and hold the *Scan* key for 1 second and scan will be halted instantly.

Scan Mode Diagram

In essence, the Scan mode display is almost identical to that of Home mode. Refer to page 35 for description of Home Mode diagram if necessary. And here we put emphasis on the introduction of relevant info of Scan Display.

Scan mode underway

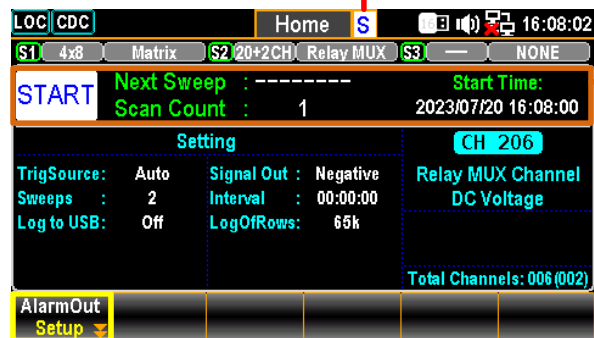

Scan Display

Function Key

Scan Display	START /STOP	The status becomes START after user presses <i>Scan</i> key. And it turns STOP after a scan course is completed or after user presses and holds <i>Scan</i> key for 1 second.
	Next Sweep	It indicates the interval actions between each sweep. The actions vary in accordance with the Trig Source setting. See page 96 for details of Interval.
	Scan Count	It indicates the completed counts of sweeps for a scan course. Scan counts of sweeps is based on Sweeps setting. See page 96 for details of Interval.
	Start Time	The latest start date and time of a scan course is displayed here.
Function Key		The operable function key <i>AlarmOut</i> during a scan course is for user to clear alarm 1 ~ alarm 4 individually or to clear all alarms if any.

Scan Function Key Selection



F1 (AlarmOut) key to clear alarm(s) during scan mode	Alarm Clear	<ul style="list-style-type: none"> ▪ Alarm1 ~ 4: Clears alarm state of a selected alarm output line. ▪ All: Clears alarm states of all 4 alarm output lines.
--	-------------	--

Scan Mode with Monitor Mode simultaneously

Description It is available for user to activate both Scan mode and Monitor mode at the same time. When Scan mode is activated with Monitor mode simultaneously, the measured reading on a select channel is updated once only when the select channel is being scanned by a sweep within a scan course.

Also, similar to the Monitor mode, it is available to navigate channels via using *knob* or *arrow* keys to watch the updated measured reading of each channel.

Scan & Monitor mode Diagram

When the select channel hasn't been scanned from the 1st sweep, it reads no measured reading on the display.

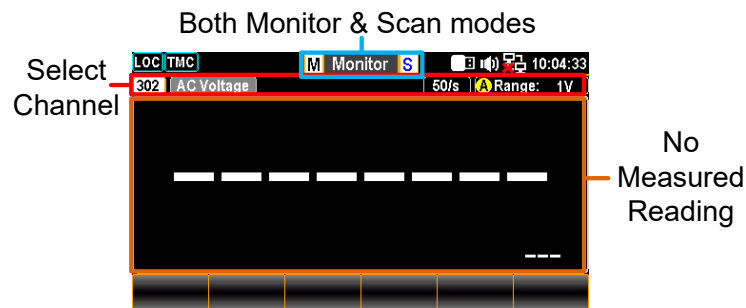

When the select channel is being scanned from a sweep within a scan course, measured reading will be displayed and be updated again only when being scanned again in the next sweep.

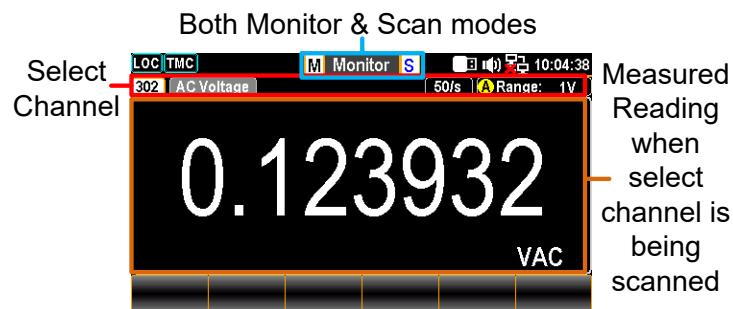

C ONFIGURATION MENUS

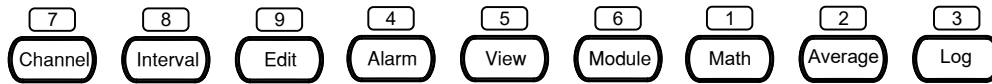

Channel Menu	54
DCV/ACV Measurement	56
Temperature Measurement.....	60
Strain Measurement	69
2-Wire & 4-Wire Resistance Measurement	80
Frequency/Period Measurement.....	82
Diode Measurement	83
Capacitance Measurement.....	84
DCI/ACI Measurement	85
Scan 2-Wire & 4-Wire Connection.....	87
DMM Off for External Device	88
Switch Mode for Channels	90
Computer Channels	92
Basic Math.....	93
Statistics	94
Polynomial 5TH	95
Interval Menu	96
Edit Menu	99
Copy Channels	100
Alarm Menu	102
Alarm Configuration	103
View Menu	105
Data View.....	105
Alarm View.....	113
Error View	114
Relay Cycle View	115

Module Menu	116
Math Menu	118
dBm Measurement	118
dB Measurement	121
MX+B Measurement.....	124
1/X Measurement.....	127
Percent Measurement	130
Average Menu	133
Log Menu	135
Capture	135
Scan Data	136

Channel Menu

Background

Press the *Channel* key on the front panel to enter the Channel menu in which various measurements can be selected for each channel from slots modules. Refer to the diagram below for details.



Channel Menu Diagram

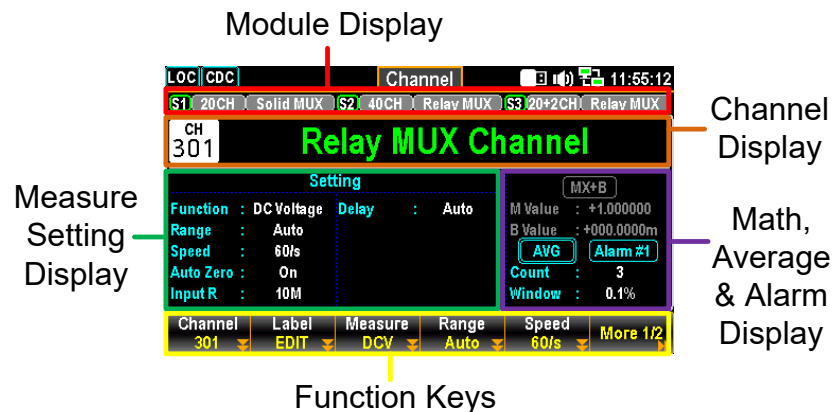

Module Display It includes module slot number and module name as well as total channels of each module. Up to 3 installed modules can be displayed.

Channel Display The select channel number along with channel name are shown here.

Measure Setting Display The parameters settings for each measurement of select channel are displayed. The available settings vary in accord with each measurement.

Math, Average & Alarm Display Math function setting for select channel is displayed. See page 118 for details of Math.
Average Count & Window setting for select channel is displayed. See page 133 for details of Average.
Alarm Hi & Lo limits setting for select channel is displayed. See page 102 for details of Alarm.
Press *knob* key to toggle between AVG and Alarm setting display.

Function Keys The operable function keys are available for user to configure measurements of each channel. Refer to the following section for more details.

Channel
Function Keys
Selection



F1 (Channel) key
to select a
channel

Press the F1 key to select a channel. Use either *numerical keypad* or rotate *knob* key to confirm selection. Also, it is available directly rotate *knob* key from Channel display to navigate channels.



F2 (Label) key to
name a channel

Press the F2 key to launch the keyboard in which user rotates *knob* key to select characters followed by clicking *Input* to confirm selection. Press *OK* to save whilst press *Exit KeyB* to exit without saving. *Caps Lock* toggles characters between high and low case. And *Backspace* simply moves cursor backwards with deleting character.



F3 (Measure)
key to configure
measurement

Measurement part contains several types of measurements with complicated settings and we will introduce in the following subchapters in details.

DCV/ACV Measurement

Description The DC and AC voltage measurements configurations.

F3 (Measure) key to select ACV or DCV

DCV



ACV



Voltage source and module terminals connection

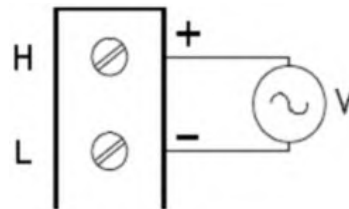

F4 (Range) key to select range for ACV and DCV

Press the key to enter Range menu and select a target range for ACV and DCV measurements individually. The Auto indicates a range, which is based on the source input, is selected automatically. It is sometimes results in, compared with manual select range, slower measurement. Also, using the *Range* keys can select range promptly.

F5 (Speed) key to select speed for ACV and DCV

Press the key to enter Speed menu and select a target speed for ACV and DCV measurements individually. Also, using the *Arrow* keys can select speed promptly.

F6 (More 1/2) key to enter next function keys page

Press the key to enter the next page (More 2/2) of more functions configurations for measurement.

Function Keys in More 2/2 page

DCV







ACV



Auto Zero (F1) key to set Auto Zero (DCV only)	By turning On Auto Zero, the most accurate measurements is provided, but it requires extra time to execute the zero measurement. With autozero On, DAQ-9600 internally measures the offset following each measurement. It then subtracts that measurement from the preceding reading. This prevents offset voltages present on the DAQ-9600 input circuitry from affecting measurement accuracy. With autozero Off, DAQ-9600 measures offset once and subtracts the offset from all subsequent measurements.
Input R (F2) key to select input resistance (DCV only)	It specifies the measurement terminal input impedance, which is 10 M Ω or Auto. The Auto mode selects high impedance (Hi-Z) for the 100 mV, 1 V and 10 V ranges, and 10 M Ω for the 100 V and 600 V ranges. In most situations, 10 M Ω is high enough to not load most circuits, but low enough to make readings stable for high impedance circuits. It also leads to readings with less noise than the (Hi-Z) option, which is included for situations where the 10 M Ω load is significant.
Delay (F5) key to select a delay time	User defines a delay time to be inserted between the actual measurement on each channel from a scan course.

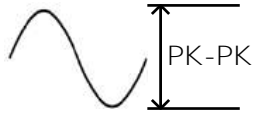

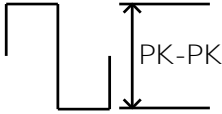

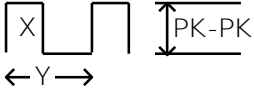
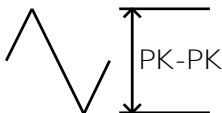

Voltage Conversion Table

Background This table shows the relationship between AC and DC reading in various waveforms.

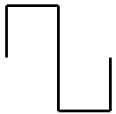
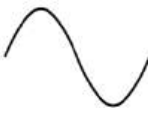
Waveform	Peak to Peak	AC (True RMS)	DC
Sine 	2.828	1.000	0.000
Rectified Sine (full wave) 	1.414	0.435	0.900
Rectified Sine (half wave) 	2.000	0.771	0.636
Square 	2.000	1.000	0.000
Rectified Square 	1.414	0.707	0.707
Rectangular Pulse 	2.000	$2K$ $K = \sqrt{(D - D^2)}$ $D = X/Y$	$2D$ $D = X/Y$
Triangle Sawtooth 	3.464	1.000	0.000

Crest Factor Table

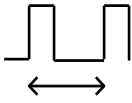
Background Crest factor is the ratio of the peak signal amplitude to the RMS value of the signal. It determines the accuracy of AC measurement. If the crest factor is less than 3.0, voltage measurement will not result in error due to dynamic range limitations at full scale. If the crest factor is more than 3.0, it usually indicates an abnormal waveform as seen from the below table.

Waveform	Shape	Crest factor
Square wave		1.0
Sine wave		1.414
Triangle sawtooth		1.732
Mixed frequencies		1.414 ~ 2.0
SCR output 100% ~ 10%		1.414 ~ 3.0
White noise		3.0 ~ 4.0
AC Coupled pulse train		>3.0
Spike		>9.0

Temperature Measurement

Description	The temperature measurements configurations. Generally, it requires a temperature transducer with the supported probes Thermocouple, Thermistor and Resistance Temperature Detector (RTD).	
Temperature Range	Thermocouple	-200°C ~ +1820°C (vary by sensor types)
	RTD	-200°C ~ +630°C
	Thermistor	-80°C ~ +150°C
 Note	Depending on varied installed modules, some temperature measurements (Thermistor, RTD) may not available.	

Thermocouple Setting

F3 (Measure) key to select TEMP

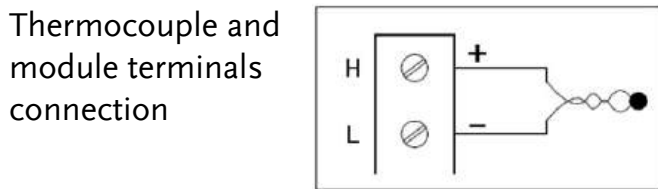

F4 (Probe) key to select TCouple

F5 (Speed) key to select speed

Press the key to enter Speed menu and select a target speed temperature measurements. Also, using the *Arrow* keys can select speed promptly.

F6 (More 1/3) key to enter next function keys page

Press the key to enter the next page (More 2/3) of more functions configurations for measurement.

Function Keys in
More 2/3 page



Auto Zero (F1) key
to set Auto Zero

By turning On Auto Zero, the most accurate measurements is provided, but it requires extra time to execute the zero measurement. With autozero On, DAQ-9600 internally measures the offset following each measurement. It then subtracts that measurement from the preceding reading. This prevents offset voltages present on the DAQ-9600 input circuitry from affecting measurement accuracy. With autozero Off, DAQ-9600 measures offset once and subtracts the offset from all subsequent measurements.

Unit (F2) key to
set temperature
unit

Press the key to enter the Temperature Unit menu followed by setting temperature measurement unit as °C (Celsius), °F (Fahrenheit), or °K.

Type (F3) key to
specify a sensor
type

Press the key to enter the sensor Type menu followed by specifying sensor type as J, K, N, R, S, T, B, or E.

Simulated (F4) key
to set up
simulated method

Press the key to enter the Simulated Method Setup menu followed by selecting Auto, Fixed or External for the so-called “Reference Junction Temperature”.

Fix Value (F5) key
for Fixed of
simulated method

When “Fixed” is selected for Simulated, press F5 key to further configure a Fix Value.

Ref CH (F5) key
for External of
simulated method

When “External” is selected for Simulated, press F5 key to further select a reference channel from the list.

F6 (More 2/3) key
to enter next
function keys page

Press the key to enter the next page (More 3/3) of more functions configurations for measurement.

Function Keys in
More 3/3 page



ADJ (F1) key to set
Auto SIM Offset

When “Auto” is selected for Simulated, press F1 key to further define an Offset value for Auto SIM.

Open Check (F3) key to set open circuit authentication In order to authenticate the proper connection of thermocouples for measurements, turn on the Open Check feature. When activated, DAQ-9600 executes a resistance measurement alongside each temperature assessment to detect any open circuits. Should one be identified, the outcome will display as +Overload. Neglecting this verification can lead to a voltage reading close to zero, rendering the temperature reading invalid. The setting is Off by default. And be aware that measurement time will be increased, more or less, due to the Open Check feature activation.

Delay (F5) key to select a delay time User defines a delay time to be inserted between the actual measurement on each channel from a scan course.

Thermocouple Sensor Type

Background The instrument accepts thermocouple inputs and calculates the temperature from the voltage difference of two dissimilar metals. Thermocouple sensor type is one of the main factors to be considered.

Parameter	Thermocouple Sensor Type	Measurement Range	Resolution
	J	-210 to +1200°C	0.002 °C
	K	-200 to +1372°C	0.002 °C
	N	-200 to +1300°C	0.003 °C
	R	-50 to +1768°C	0.01 °C
	S	-50 to +1768°C	0.01 °C
	T	-200 to +400°C	0.002 °C
	B	+250 to +1820°C	0.01 °C
	E	-200 to +1000°C	0.002 °C

Reference Junction Temperature (SIM Temperature)

Background
(Thermocouple
only)

When a thermocouple is connected to the DAQ-9600, the temperature difference between the thermocouple lead and the DAQ-9600 input terminal should be taken into account and be cancelled out; otherwise an erroneous temperature might be added. The value of the reference junction temperature should be determined by the user.

Type	Range	Resolution
SIM (simulated)	-20°C ~ +80°C	0.01°C

The terminal temperature is manually defined by user.

Default value: Auto

Thermistor 2W/4W Setting

F3 (Measure) key to select TEMP

TEMP

Channel	Label	Measure	Probe	Speed	More 1/3
201	EDIT	TEMP	Them2W	60/s	▶▶

F4 (Probe) key to select Them2W or Them4W

Them2W

Channel	Label	Measure	Probe	Speed	More 1/3
201	EDIT	TEMP	Them2W	60/s	▶▶

Them4W

Channel	Label	Measure	Probe	Speed	More 1/3
201	EDIT	TEMP	Them4W	60/s	▶▶

Thermistor and module terminals connection

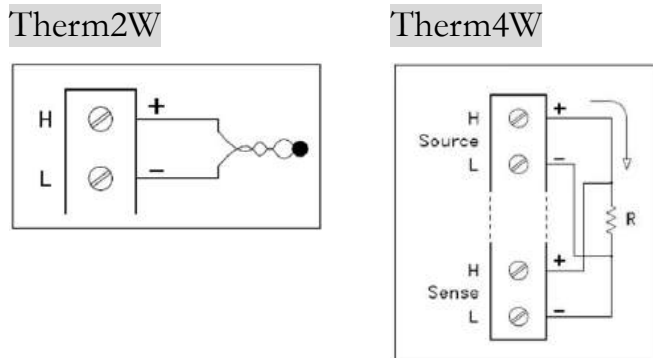

Parameter	Type	Range	Resolution
	All	-80~150°C	0.001°C

F5 (Speed) key to select speed
 Press the key to enter Speed menu and select a target speed temperature measurements. Also, using the *Arrow* keys can select speed promptly.

F6 (More 1/3) key to enter next function keys page
 Press the key to enter the next page (More 2/3) of more functions configurations for measurement.

Function Keys in More 2/3 page

Auto Zero	Unit	Type	User Type	Use as Ref	More 2/3
On Off	°C	User	Setup	On Off	▶▶

Auto Zero (F1) key to set Auto Zero By turning On Auto Zero, the most accurate measurements is provided, but it requires extra time to execute the zero measurement. With autozero On, DAQ-9600 internally measures the offset following each measurement. It then subtracts that measurement from the preceding reading. This prevents offset voltages present on the DAQ-9600 input circuitry from affecting measurement accuracy. With autozero Off, DAQ-9600 measures offset once and subtracts the offset from all subsequent measurements.

Unit (F2) key to set temperature unit Press the key to enter the Temperature Unit menu followed by setting temperature measurement unit as °C (Celsius), °F (Fahrenheit), or °K.

Type (F3) key to specify a sensor type Press the key to enter the sensor Type menu followed by specifying sensor type as 2.2kΩ, 5kΩ, 10kΩ or User type.

User Type (F4) key to set up User Type coefficients When “User” is selected for Type, press F4 key to further customize A, B and C coefficients individually as defined by the Steinhart–Hart equation.

Type	A	B	C
2.2k	0.0014733	0.0002372	1.07E-07
5k	0.0012880	0.0002356	9.56E-08
10k	0.0010295	0.0002391	1.57E-07

Equation

$$T_K = \frac{1}{A + B(\ln R) + C(\ln R)^3}$$

where: T_K is the calculated temperature in Kelvin.

$\ln R$ is the natural log of the measured resistance of the thermistor.

A, B, and C are the curve fitting constants.

Use as Ref (F5) key to enable Enable Use as Ref to make selected channel be used as the reference channel for subsequent thermocouple measurements that specify an external reference source.

F6 (More 2/3) key to enter next function keys page Press the key to enter the next page (More 3/3) of more functions configurations for measurement.

Function Keys in More 3/3 page



Power Low (F3) key to enable Selects the low-power resistance measurement, which sources less current resulting in lower power dissipation, and less self-heating, in the resistance under test. Typically, this is about 1/10th the current sourced for the standard resistance measurements and is only for the condition of equal to or less than 100k.

Delay (F5) key to select a delay time User defines a delay time to be inserted between the actual measurement on each channel from a scan course.

RTD 2W/4W Setting

F3 (Measure) key to select TEMP



F4 (Probe) key to select RTD 2W or RTD 4W



RTD and module terminals connection

RTD 2W

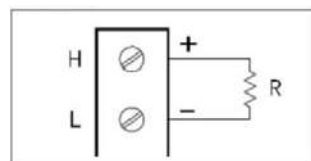

RTD 4W

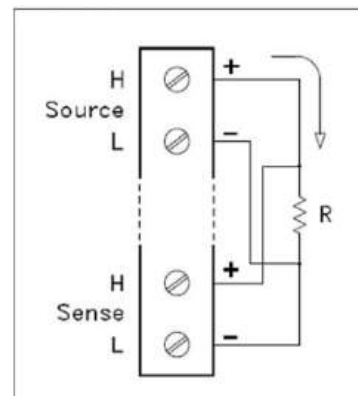

Parameter	RTD type	Range	Resolution
	All (based on PT100)	-200~630°C	0.001°C

F5 (Speed) key to select speed Press the key to enter Speed menu and select a target speed temperature measurements. Also, using the *Arrow* keys can select speed promptly.

F6 (More 1/3) key to enter next function keys page Press the key to enter the next page (More 2/3) of more functions configurations for measurement.

Function Keys in More 2/3 page

Auto Zero (F1) key to set Auto Zero By turning On Auto Zero, the most accurate measurements is provided, but it requires extra time to execute the zero measurement. With autozero On, DAQ-9600 internally measures the offset following each measurement. It then subtracts that measurement from the preceding reading. This prevents offset voltages present on the DAQ-9600 input circuitry from affecting measurement accuracy. With autozero Off, DAQ-9600 measures offset once and subtracts the offset from all subsequent measurements.

Unit (F2) key to set temperature unit Press the key to enter the Temperature Unit menu followed by setting temperature measurement unit as °C (Celsius), °F (Fahrenheit), or °K.

Type (F3) key to specify a sensor type Press the key to enter the sensor Type menu followed by specifying sensor type as PT100, D100, F100, PT385, PT3916 or User type.

User Type (F4) key to set up User Type coefficients When “User” is selected for Type, press F4 key to further customize alpha, beta, delta and R0 coefficients individually as defined by the Callendar–Van Dusen equation.

Type	Alpha (α)	Beta (β)	Delta (δ)
PT100	0.00385	0.10863	1.49990
D100	0.00392	0.10630	1.49710
F100	0.00390	0.11000	1.49589
PT385	0.00385	0.11100	1.50700
PT3916	0.00392	0.11600	1.50594

Equation -200°C to 0°C range

$$R_{RTD} = R_0[1+AT+BT^2+CT^3 (T-100)]$$

where: R_{RTD} is the calculated resistance of the RTD
 R_0 is the known RTD resistance at 0°C
 T is the temperature in °C

$$A = \alpha [1 + (\delta/100)]$$

$$B = -1 (\alpha)(\delta)(1e-4)$$

$$C = -1 (\alpha)(\beta)(1e-8)$$

-0°C to 630°C range

$$R_{RTD} = R_0 (1+AT+BT^2)$$

where: R_{RTD} is the calculated resistance of the RTD
 R_0 is the known RTD resistance at 0°C
 T is the temperature in °C

$$A = \alpha [1 + (\delta/100)]$$

$$B = -1 (\alpha)(\delta)(1e-4)$$

Use as Ref (F5) key to enable Enable Use as Ref to make selected channel be used as the reference channel for subsequent thermocouple measurements that specify an external reference source.

F6 (More 2/3) key to enter next function keys page Press the key to enter the next page (More 3/3) of more functions configurations for measurement.

Function Keys in More 3/3 page



Power Low (F3) key to enable Selects the low-power resistance measurement, which sources less current resulting in lower power dissipation, and less self-heating, in the resistance under test. Typically, this is about 1/10th the current sourced for the standard resistance measurements and is only for the condition of equal to or less than 100k.

Delay (F5) key to select a delay time User defines a delay time to be inserted between the actual measurement on each channel from a scan course.

Strain Measurement

Description The strain measurements configurations. Generally, a body deforms when a force is applied to the body. The deformation per unit length is the so-called strain. Strain may be either compressive (-) or tensile (+).

DAQ-9600 supports two types of strain measurements which are Bridge and Direct resistive methods.

After configuring strain measurement function for channels, go to Home menu to get the unstrained offset value, which will be subtracted from strain measurements before the strain conversion is executed. Refer to page 38 for details of how to get unstrained offset value.

Full & Half Bending Bridge Setting

<p>F3 (Measure) key to select STRAIN</p>	<p>STRAIN</p> <table border="1"> <tr> <td>Channel 201</td> <td>Label EDIT</td> <td>Measure STRAIN</td> <td>Range Auto</td> <td>Speed 60/s</td> <td>More 1/3</td> </tr> </table>	Channel 201	Label EDIT	Measure STRAIN	Range Auto	Speed 60/s	More 1/3
Channel 201	Label EDIT	Measure STRAIN	Range Auto	Speed 60/s	More 1/3		
<p>Bridge source and module terminals connection</p>	<table border="1"> <tr> <td data-bbox="542 1108 973 1299"> <p>Full Bending Bridge</p> </td> <td data-bbox="973 1108 1409 1299"> <p>Half Bending Bridge</p> </td> </tr> </table>	<p>Full Bending Bridge</p>	<p>Half Bending Bridge</p>				
<p>Full Bending Bridge</p>	<p>Half Bending Bridge</p>						
<p>F4 (Range) key to select range</p>	<p>Press the key to enter Range menu and select a target range for strain measurement. The Auto indicates a range, which is based on the source input, is selected automatically. It is sometimes results in, compared with manual select range, slower measurement. Also, using the <i>Range</i> keys can select range promptly.</p>						
<p>F5 (Speed) key to select speed</p>	<p>Press the key to enter Speed menu and select a target speed temperature measurements. Also, using the <i>Arrow</i> keys can select speed promptly.</p>						
<p>F6 (More 1/3) key to enter next function keys page</p>	<p>Press the key to enter the next page (More 2/3) of more functions configurations for measurement.</p>						

Function Keys in
More 2/3 page

Full Bending Bridge



Half Bending Bridge



Auto Zero (F1) key
to set Auto Zero

By turning On Auto Zero, the most accurate measurements is provided, but it requires extra time to execute the zero measurement. With autozero On, DAQ-9600 internally measures the offset following each measurement. It then subtracts that measurement from the preceding reading. This prevents offset voltages present on the DAQ-9600 input circuitry from affecting measurement accuracy. With autozero Off, DAQ-9600 measures offset once and subtracts the offset from all subsequent measurements.

Sense (F2) key to
select Bridge

Press the key to enter the Sense menu followed by selecting Bridge for sense.

Config (F3) key to
specify Full or Half

Press the key to enter the Config menu followed by selecting either Full or Half.

Type (F4) key to
select Bending

Press the key to enter the Type menu followed by selecting Bending for type.

GageFactor (F5)
key to specify a
ratio

Gage factor indicates the ratio of fractional change in resistance to, along the axis of the gage, the fractional change in length (strain). The more sensitive strain gage, the larger the value. Gage factor itself is a dimensionless quantity with the default value of approximate 2.

F6 (More 2/3) key
to enter next
function keys page

Press the key to enter the next page (More 3/3) of more functions configurations for measurement.

Function Keys in
More 3/3 page



Excitation (F2) key Strain bridge conversions require the voltage of the external bridge excitation, for which user can designate a multiplexer channel to measure the excitation voltage or can specify a known fixed voltage value.

Fixed (Fix) - The fixed value specified by the excitation voltage will be used for the strain conversion.

External (Ext) - DCV measurements on the enabled reference channel will be used for subsequent strain bridge measurements that specify an external excitation voltage source. Note that the external DCV reference channel must be a lower-numbered channel than the strain channel.

EXCI Volt (F3) key When “Fix” is selected for Excitation, press F3 key to further configure an excitation voltage applied to the bridge by an external voltage source. This value will be used to convert strain bridge measurements on the selected channel.

Ext Chan. (F3) key When “Ext” is selected for Excitation, press F3 key to further select a reference channel from the list.

Delay (F5) key to select a delay time User defines a delay time to be inserted between the actual measurement on each channel from a scan course.

Full & Half Poisson Bridge Setting

F3 (Measure) key to select STRAIN

STRAIN					
Channel	Label	Measure	Range	Speed	More 1/3
201	EDIT	STRAIN	Auto	60/s	More 1/3

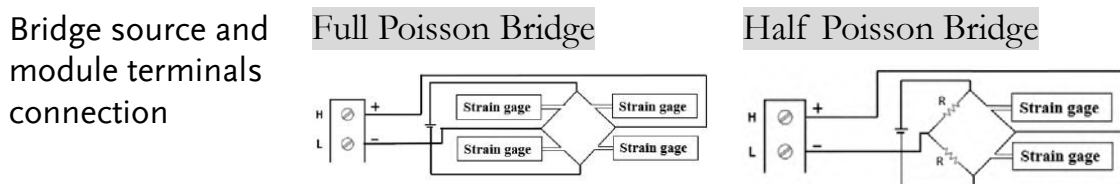

F4 (Range) key to select range Press the key to enter Range menu and select a target range for strain measurement. The Auto indicates a range, which is based on the source input, is selected automatically. It is sometimes results in, compared with manual select range, slower measurement. Also, using the *Range* keys can select range promptly.

F5 (Speed) key to select speed Press the key to enter Speed menu and select a target speed temperature measurements. Also, using the *Arrow* keys can select speed promptly.

F6 (More 1/3) key to enter next function keys page Press the key to enter the next page (More 2/3) of more functions configurations for measurement.

Function Keys in More 2/3 page

Full Poisson Bridge



Half Poisson Bridge



Auto Zero (F1) key to set Auto Zero By turning On Auto Zero, the most accurate measurements is provided, but it requires extra time to execute the zero measurement. With autozero On, DAQ-9600 internally measures the offset following each measurement. It then subtracts that measurement from the preceding reading. This prevents offset voltages present on the DAQ-9600 input circuitry from affecting measurement accuracy. With autozero Off, DAQ-9600 measures offset once and subtracts the offset from all subsequent measurements.

Sense (F2) key to select Bridge Press the key to enter the Sense menu followed by selecting Bridge for sense.

Config (F3) key to specify Full or Half Press the key to enter the Config menu followed by selecting either Full or Half.

Type (F4) key to select Poisson Press the key to enter the Type menu followed by selecting Poisson, which is defined as the negative ratio of the strain in the transverse direction to the strain in the longitudinal direction.

GageFactor (F5) key to specify a ratio Gage factor indicates the ratio of fractional change in resistance to, along the axis of the gage, the fractional change in length (strain). The more sensitive strain gage, the larger the value. Gage factor itself is a dimensionless quantity with the default value of approximate 2.

F6 (More 2/3) key to enter next function keys page Press the key to enter the next page (More 3/3) of more functions configurations for measurement.

Function Keys in More 3/3 page



PoisRatio(F1) key User specifies a Poisson ratio, which is defined as the negative ratio of the strain in the transverse direction to the strain in the longitudinal direction, of the strain gage.

Excitation (F2) key Strain bridge conversions require the voltage of the external bridge excitation, for which user can designate a multiplexer channel to measure the excitation voltage or can specify a known fixed voltage value.

Fixed (Fix) - The fixed value specified by the excitation voltage will be used for the strain conversion.

External (Ext) - DCV measurements on the enabled reference channel will be used for subsequent strain bridge measurements that specify an external excitation voltage source. Note that the external DCV reference channel must be a lower-numbered channel than the strain channel.

EXCI Volt (F3) key When “Fix” is selected for Excitation, press F3 key to further configure an excitation voltage applied to the bridge by an external voltage source. This value will be used to convert strain bridge measurements on the selected channel.

Ext Chan. (F3) key When “Ext” is selected for Excitation, press F3 key to further select a reference channel from the list.

Delay (F5) key to select a delay time User defines a delay time to be inserted between the actual measurement on each channel from a scan course.

Full Bending Poisson Bridge Setting

F3 (Measure) key to select STRAIN

STRAIN					
Channel	Label	Measure	Range	Speed	More 1/3
201	EDIT	STRAIN	Auto	60/s	

Bridge source and module terminals connection

Full Bending Poisson Bridge

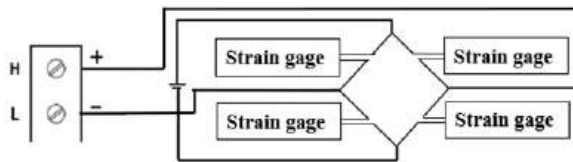

F4 (Range) key to select range

Press the key to enter Range menu and select a target range for strain measurement. The Auto indicates a range, which is based on the source input, is selected automatically. It is sometimes results in, compared with manual select range, slower measurement. Also, using the *Range* keys can select range promptly.

F5 (Speed) key to select speed

Press the key to enter Speed menu and select a target speed temperature measurements. Also, using the *Arrow* keys can select speed promptly.

F6 (More 1/3) key to enter next function keys page

Press the key to enter the next page (More 2/3) of more functions configurations for measurement.

Function Keys in More 2/3 page

Full Bending Poisson Bridge					
Auto Zero	Sense	Config	Type	GageFactor	More 2/3
On	Bridge	Full	BendPois	2.000	

Auto Zero (F1) key to set Auto Zero

By turning On Auto Zero, the most accurate measurements is provided, but it requires extra time to execute the zero measurement. With autozero On, DAQ-9600 internally measures the offset following each measurement. It then subtracts that measurement from the preceding reading. This prevents offset voltages present on the DAQ-9600 input circuitry from affecting measurement accuracy. With autozero Off, DAQ-9600 measures offset once and subtracts the offset from all subsequent measurements.

Sense (F2) key to select Bridge

Press the key to enter the Sense menu followed by selecting Bridge for sense.

Config (F3) key to specify Full	Press the key to enter the Config menu followed by selecting Full.
Type (F4) key to select BendPois	Press the key to enter the Type menu followed by selecting BendPois for type, which is a combination ratio of Bending and Poisson.
GageFactor (F5) key to specify a ratio	Gage factor indicates the ratio of fractional change in resistance to, along the axis of the gage, the fractional change in length (strain). The more sensitive strain gage, the larger the value. Gage factor itself is a dimensionless quantity with the default value of approximate 2.
F6 (More 2/3) key to enter next function keys page	Press the key to enter the next page (More 3/3) of more functions configurations for measurement.
Function Keys in More 3/3 page	
PoisRatio(F1) key	User specifies a Poisson ratio, which is defined as the negative ratio of the strain in the transverse direction to the strain in the longitudinal direction, of the strain gage.
Excitation (F2) key	<p>Strain bridge conversions require the voltage of the external bridge excitation, for which user can designate a multiplexer channel to measure the excitation voltage or can specify a known fixed voltage value.</p> <p>Fixed (Fix) - The fixed value specified by the excitation voltage will be used for the strain conversion.</p> <p>External (Ext) - DCV measurements on the enabled reference channel will be used for subsequent strain bridge measurements that specify an external excitation voltage source. Note that the external DCV reference channel must be a lower-numbered channel than the strain channel.</p>
EXCI Volt (F3) key	When “Fix” is selected for Excitation, press F3 key to further configure an excitation voltage applied to the bridge by an external voltage source. This value will be used to convert strain bridge measurements on the selected channel.
Ext Chan. (F3) key	When “Ext” is selected for Excitation, press F3 key to further select a reference channel from the list.

Delay (F5) key to select a delay time User defines a delay time to be inserted between the actual measurement on each channel from a scan course.

Quarter Bridge Setting

F3 (Measure) key to select STRAIN



Bridge source and module terminals connection

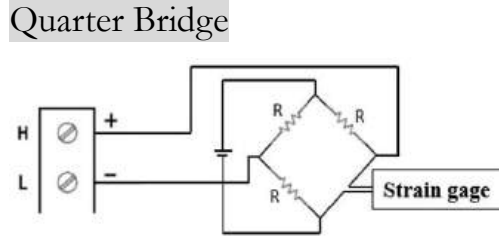

F4 (Range) key to select range Press the key to enter Range menu and select a target range for strain measurement. The Auto indicates a range, which is based on the source input, is selected automatically. It is sometimes results in, compared with manual select range, slower measurement. Also, using the *Range* keys can select range promptly.

F5 (Speed) key to select speed Press the key to enter Speed menu and select a target speed temperature measurements. Also, using the *Arrow* keys can select speed promptly.

F6 (More 1/3) key to enter next function keys page Press the key to enter the next page (More 2/3) of more functions configurations for measurement.

Function Keys in More 2/3 page



Auto Zero (F1) key to set Auto Zero By turning On Auto Zero, the most accurate measurements is provided, but it requires extra time to execute the zero measurement. With autozero On, DAQ-9600 internally measures the offset following each measurement. It then subtracts that measurement from the preceding reading. This prevents offset voltages present on the DAQ-9600 input circuitry from affecting measurement accuracy. With autozero Off, DAQ-9600 measures offset once and subtracts the offset from all subsequent Bridge measurements.

Sense (F2) key to select Bridge Press the key to enter the Sense menu followed by selecting Bridge for sense.

Config (F3) key to specify Quarter Press the key to enter the Config menu followed by selecting Quarter.

GageFactor (F5) key to specify a ratio Gage factor indicates the ratio of fractional change in resistance to, along the axis of the gage, the fractional change in length (strain). The more sensitive strain gage, the larger the value. Gage factor itself is a dimensionless quantity with the default value of approximate 2.

F6 (More 2/3) key to enter next function keys page Press the key to enter the next page (More 3/3) of more functions configurations for measurement.

Function Keys in More 3/3 page



Excitation (F2) key Strain bridge conversions require the voltage of the external bridge excitation, for which user can designate a multiplexer channel to measure the excitation voltage or can specify a known fixed voltage value.

Fixed (Fix) - The fixed value specified by the excitation voltage will be used for the strain conversion.

External (Ext) - DCV measurements on the enabled reference channel will be used for subsequent strain bridge measurements that specify an external excitation voltage source. Note that the external DCV reference channel must be a lower-numbered channel than the strain channel.

EXCI Volt (F3) key When “Fix” is selected for Excitation, press F3 key to further configure an excitation voltage applied to the bridge by an external voltage source. This value will be used to convert strain bridge measurements on the selected channel.

Ext Chan. (F3) key When “Ext” is selected for Excitation, press F3 key to further select a reference channel from the list.

Delay (F5) key to select a delay time User defines a delay time to be inserted between the actual measurement on each channel from a scan course.

2W & 4W Direct Setting

F3 (Measure) key to select STRAIN

STRAIN

Channel	Label	Measure	Range	Speed	More 1/3
201	EDIT	STRAIN	Fix 1kΩ	60/s	

Direct source and module terminals connection

2W Direct

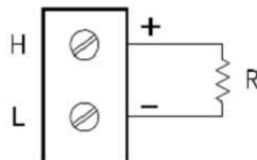

4W Direct

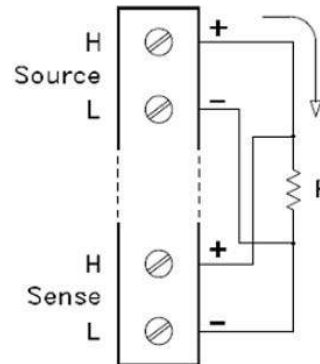

F4 (Range) key is fixed in Fix 1kΩ

Under the either 2W or 4W Direct setting, the Range is fixed in Fix 1kΩ by default.

F5 (Speed) key to select speed

Press the key to enter Speed menu and select a target speed temperature measurements. Also, using the *Arrow* keys can select speed promptly.

F6 (More 1/3) key to enter next function keys page

Press the key to enter the next page (More 2/3) of more functions configurations for measurement.

Function Keys in More 2/3 page

2W Direct

Auto Zero	Sense	Config	GageOhms	GageFactor	More 2/3
On Off	Direct	2-Wire	120.00	2.000	

4W Direct

Auto Zero	Sense	Config	GageOhms	GageFactor	More 2/3
On Off	Direct	4-Wire	120.00	2.000	

Auto Zero (F1) key to set Auto Zero By turning On Auto Zero, the most accurate measurements is provided, but it requires extra time to execute the zero measurement. With autozero On, DAQ-9600 internally measures the offset following each measurement. It then subtracts that measurement from the preceding reading. This prevents offset voltages present on the DAQ-9600 input circuitry from affecting measurement accuracy. With autozero Off, DAQ-9600 measures offset once and subtracts the offset from all subsequent measurements.

Sense (F2) key to select Direct Press the key to enter the Sense menu followed by selecting Direct for sense.

Config (F3) key to specify 2-Wire or 4-Wire Press the key to enter the Config menu followed by selecting either 2-Wire or 4-Wire.

GageOhms (F4) key to specify resistance Press the key to specify Gage resistance, which is used to convert direct strain measurements on selected channel.

GageFactor (F5) key to specify a ratio Gage factor indicates the ratio of fractional change in resistance to, along the axis of the gage, the fractional change in length (strain). The more sensitive strain gage, the larger the value. Gage factor itself is a dimensionless quantity with the default value of approximate 2.

F6 (More 2/3) key to enter next function keys page Press the key to enter the next page (More 3/3) of more functions configurations for measurement.

Function Keys in More 3/3 page



PowerLow (F3) key Selects the low-power resistance measurement, which sources less current resulting in lower power dissipation, and less self-heating, in the resistance under test. Typically, this is about 1/10th the current sourced for the standard resistance measurements and is only for the condition of equal to or less than 100k.

Delay (F5) key to select a delay time User defines a delay time to be inserted between the actual measurement on each channel from a scan course.

2-Wire & 4-Wire Resistance Measurement

Description The resistance measurements configurations. Generally, the 2-Wire resistance indicates using the standard Input HI-LO terminals and it is recommended for measuring resistances larger than 1kΩ. And 4-Wire resistance indicates compensating the test lead effect using the 4W compensation terminals, in addition to the standard Input HI-LO terminals. Recommended for measuring sensitive resistances smaller than 1kΩ.

F3 (Measure) key to select 2W OHM or 4W OHM

2W OHM

Channel	Label	Measure	Range	Speed	More 1/2
109	Edit	2W OHM	Auto	60/s	

4W OHM

Channel	Label	Measure	Range	Speed	More 1/2
109	Edit	4W OHM	Auto	60/s	

Resistance source and module terminals connection

2W OHM

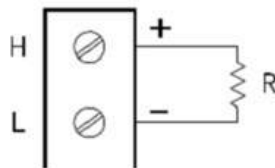

4W OHM

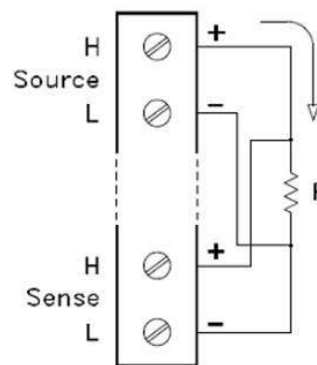

F4 (Range) key to specify range

Press the key to enter Range menu and select a target range for 2W OHM and 4W OHM measurements individually. The Auto indicates a range, which is based on the source input, is selected automatically. It is sometimes results in, compared with manual select range, slower measurement. Also, using the *Range keys* can select range promptly.

Selectable Resistance Ranges	Range	Resolution	Full scale
	100Ω	0.1mΩ	119.9999Ω
	1kΩ	1mΩ	1.199999kΩ
	10kΩ	10mΩ	11.99999kΩ

100kΩ	100mΩ	119.9999kΩ
1MΩ	1Ω	1.199999MΩ
10MΩ	10Ω	11.99999MΩ
100MΩ	100Ω	119.9999MΩ
1GΩ	XXX	XXXX

F5 (Speed) key to select speed Press the key to enter Speed menu and select a target speed temperature measurements. Also, using the *Arrow* keys can select speed promptly.

F6 (More 1/2) key to enter next function keys page Press the key to enter the next page (More 2/2) of more functions configurations for measurement.

Function Keys in More 2/2 page



Auto Zero (F1) key to set Auto Zero By turning On Auto Zero, the most accurate measurements is provided, but it requires extra time to execute the zero measurement. With autozero On, DAQ-9600 internally measures the offset following each measurement. It then subtracts that measurement from the preceding reading. This prevents offset voltages present on the DAQ-9600 input circuitry from affecting measurement accuracy. With autozero Off, DAQ-9600 measures offset once and subtracts the offset from all subsequent measurements.

PowerLow (F3) key Selects the low-power resistance measurement, which sources less current resulting in lower power dissipation, and less self-heating, in the resistance under test. Typically, this is about 1/10th the current sourced for the standard resistance measurements and is only for the condition of equal to or less than 100k.

Delay (F5) key to select a delay time User defines a delay time to be inserted between the actual measurement on each channel from a scan course.

Frequency/Period Measurement

Description The frequency/period measurements configurations.

F3 (Measure) key to select either Frequency or Period

FREQ

Channel	Label	Measure	Range	GateTime	More 1/2
201	EDIT	FREQ	Auto	100ms	

PERIOD

Channel	Label	Measure	Range	GateTime	More 1/2
201	EDIT	PERIOD	Auto	100ms	

Input source and module terminals connection

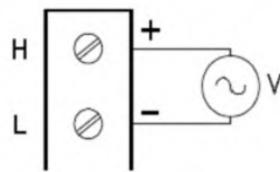

F4 (Range) key to specify range

Press the key to enter Range menu and select a target range for Frequency/Period measurements individually. The Auto indicates a range, which is based on the source input, is selected automatically. It is sometimes results in, compared with manual select range, slower measurement. Also, using the *Range* keys can select range promptly.

F5 (GeteTime) key to select speed

Press the key to specify the threshold to recalculate Frequency/Period. Slower the gate time, e.g., 1s, more accurate the reading value.

F6 (More 1/2) key to enter next function keys page

Press the key to enter the next page (More 2/2) of more functions configurations for measurement.

Function Keys in More 2/2 page

TimeOut			Delay	More 2/2
Auto			Auto	

TimeOut (F1) key to define value

It defines the exact value for timeout, which means measurement will be suspended after reaching the set timeout value when none of input is detected. Note that when selecting “Auto”, the timeout setting will fully sync with the Gate Time value.

Delay (F5) key to select a delay time

User defines a delay time to be inserted between the actual measurement on each channel from a scan course.

Diode Measurement

Description The diode measurement configurations.

F3 (Measure) key to select Diode



Diode source and module terminals connection

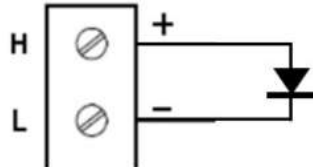

F4 (Range) key is fixed in 5V

The Range selection is fixed in 5V for Diode measurement.

F5 (Speed) key to select speed

Press the key to enter Speed menu and select a target speed for Diode measurement. Also, using the *Arrow* keys can select speed promptly.

F6 (More 1/2) key to enter next function keys page

Press the key to enter the next page (More 2/2) of more functions configurations for measurement.

Function Keys in More 2/2 page



Auto Zero (F1) key to set Auto Zero

By turning On Auto Zero, the most accurate measurements is provided, but it requires extra time to execute the zero measurement. With autozero On, DAQ-9600 internally measures the offset following each measurement. It then subtracts that measurement from the preceding reading. This prevents offset voltages present on the DAQ-9600 input circuitry from affecting measurement accuracy. With autozero Off, DAQ-9600 measures offset once and subtracts the offset from all subsequent measurements.

Delay (F5) key to select a delay time

User defines a delay time to be inserted between the actual measurement on each channel from a scan course.

Capacitance Measurement

Description The capacitance measurement configurations.

F3 (Measure) key to select capacitance



Capacitance source and module terminals connection

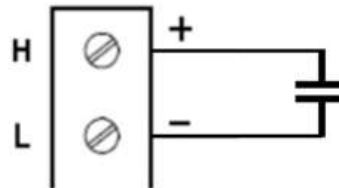

F4 (Range) key to specify range

Press the key to enter Range menu and select a target range for capacitance measurement. The Auto indicates a range, which is based on the source input, is selected automatically. It is sometimes results in, compared with manual select range, slower measurement. Also, using the *Range* keys can select range promptly.

F5 (Speed) key is fixed in Auto

The Speed selection is fixed in Auto for Capacitance measurement.

F6 (More 1/2) key to enter next function keys page

Press the key to enter the next page (More 2/2) of more functions configurations for measurement.

Function Keys in More 2/2 page



Delay (F5) key to select a delay time

User defines a delay time to be inserted between the actual measurement on each channel from a scan course.

DCI/ACI Measurement

Description The DCI and ACI current measurements configurations.

Note Both DC and AC current measurements are available on the channels 21 and 22 of DAQ901 module only.

F3 (Measure) key to select either ACI or DCI

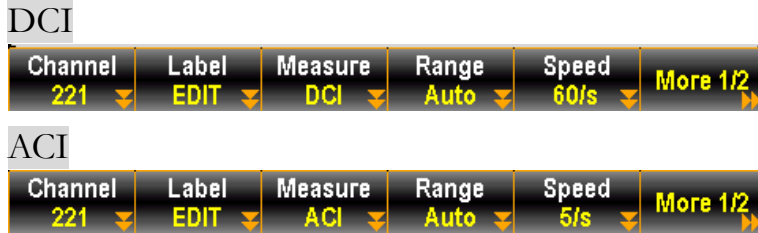

Current sources and module terminals connection

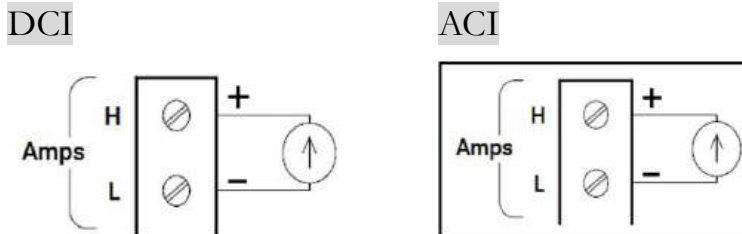

F4 (Range) key to select range for ACI and DCI

Press the key to enter Range menu and select a target range for ACI and DCI measurements individually. The Auto indicates a range, which is based on the source input, is selected automatically. It is sometimes results in, compared with manual select range, slower measurement. Also, using the *Range* keys can select range promptly.

F5 (Speed) key to select speed for ACI and DCI

Press the key to enter Speed menu and select a target speed for ACI and DCI measurements individually. Also, using the *Arrow* keys can select speed promptly.

F6 (More 1/2) key to enter next function keys page

Press the key to enter the next page (More 2/2) of more functions configurations for measurement.

Function Keys in More 2/2 page

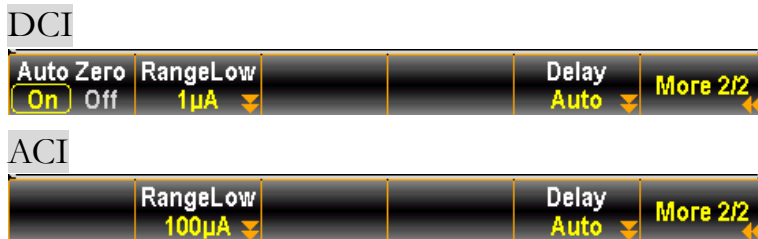

Auto Zero (F1) key to set Auto Zero (DCI only)	By turning On Auto Zero, the most accurate measurements is provided, but it requires extra time to execute the zero measurement. With autozero On, DAQ-9600 internally measures the offset following each measurement. It then subtracts that measurement from the preceding reading. This prevents offset voltages present on the DAQ-9600 input circuitry from affecting measurement accuracy. With autozero Off, DAQ-9600 measures offset once and subtracts the offset from all subsequent measurements.
Range Low (F2) key to select rate	The range of current is limited within the select low ranges when Auto range is activated. This function is effective by utilizing low impedance to lessen errors from shunt when current range changes overly.
Delay (F5) key to select a delay time	User defines a delay time to be inserted between the actual measurement on each channel from a scan course.

Scan 2-Wire & 4-Wire Connection

Description The 2-wire and 4-wire connections are available for diversified measurements connected with external DMM unit when internal DMM function is disabled. In accord with varied measurements for different DUTs, select and physically wire the applicable 2W or 4W connections.

 **Note** Only when DMM function is deactivated can both “Scan 2W” and “Scan 4W” options for Measure be available. Refer to page 37 and page 88 for details.

F3 (Measure) key to select either Scan 2W or Scan 4W

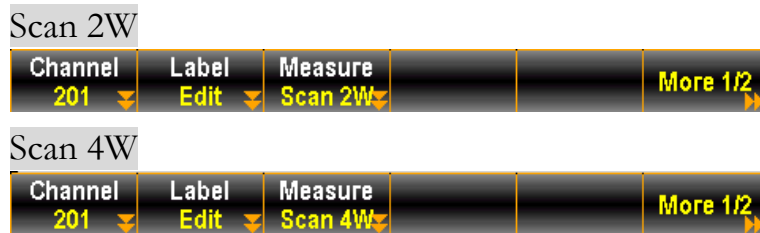

F6 (More 1/2) key to enter next function keys page

Press the key to enter the next page (More 2/2) of more functions configurations for measurement.

Function Keys in More 2/2 page



Delay (F5) key to select a delay time

User defines a delay time to be inserted between the actual measurement on each channel from a scan course.

DMM Off for External Device

Introduction Essentially, DAQ-9600 is equipped with internal DMM function that allows up to three multi-channel modules installed to measure various connected DUTs. However, depending on specific applications, user may need to, for instance, connect an external DMM for measurement while still maintaining the DAQ-9600's capability to connect multi-channel modules to several DUTs simultaneously.

In such case, turn off the internal DMM function, allowing DAQ-9600 to act purely as a multi-channel switch hub, rerouting signals received from the connected DUTs and send to the external DMM, which is connected to the Common Terminal (COM) of multi-channel module, for measurement.

To construct scanning with an external DMM, two control lines are required for 2-Wire scan and, on the other hands, four control lines required for 4-Wire scan. Once DAQ-9600 and external DMM are properly configured, they can synchronize the scan sequence.

For an externally controlled scan, DAQ-9600's internal DMM must be disabled by navigating through **Home key > F3 key (DMM)** to turn Off internal DMM function.

Once the internal DMM is Off, readings from the multi-channel modules are no longer stored in the internal DMM memory.

In addition, DAQ-9600 must inform the external DMM when a relay is closed and settled and DAQ-9600 outputs a Channel Closed pulse from pin 5 on the rear-panel connector.

In return, the external DMM must inform DAQ-9600 when it has completed its measurement and is ready to advance to the next channel in the scan list.

Thus, DAQ-9600 receives a Channel Advance signal on the External Trigger input line (pin 6).

Also, user can configure the list of channels for 4-Wire external scanning. When enabled, the instrument automatically pairs channel n with channel n+10.

Scan 4-Wire
w/t External
DMM When
Internal
DMM Off

SCAN 4W

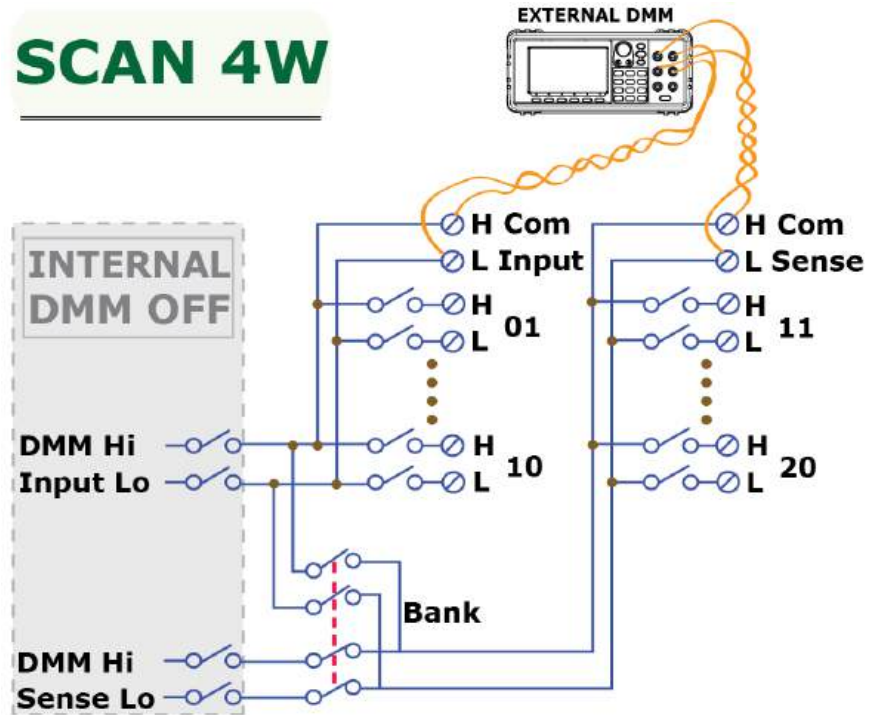

Scan 2-Wire
w/t External
DMM When
Internal
DMM Off

SCAN 2W

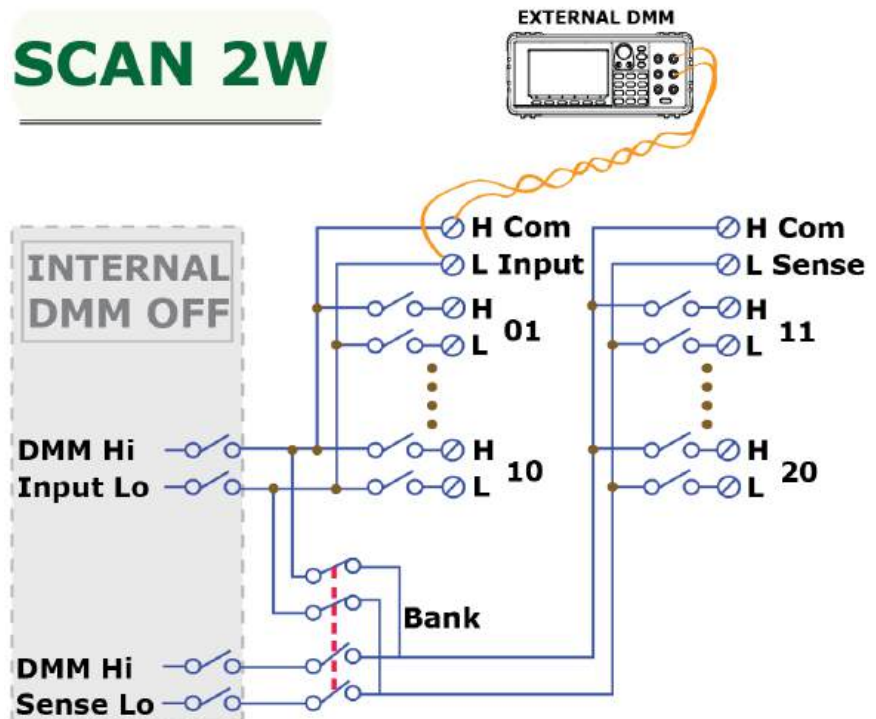

Switch Mode for Channels

Background The Switch mode from multiplexer modules empowers user to open and close channels individually. We will introduce how to turn on and configure channels to the Switch mode in details.

Note Switch mode is available on the multiplexer DAQ900, DAQ901 and DAQ903 modules only.

Steps

1. From the instance below in the Channel menu, the channel 101 is configured to measure mode STRAIN.

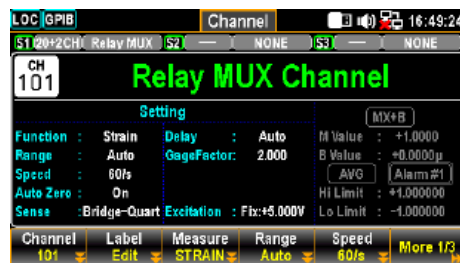

2. Press the *Module* key from the front panel followed by clicking the *ViewMode* key and then *CH List* key.

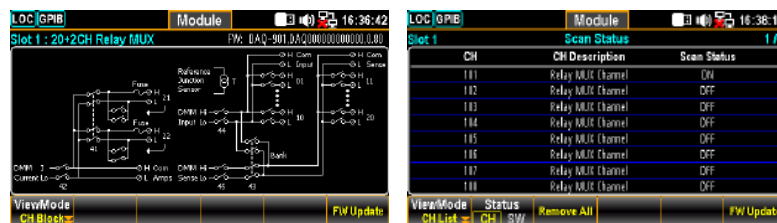

3. Use the *Knob* key to navigate through pages of a module (Slot 1 in the instance). It is seen that only the channel 101 is turned ON in Scan Status (measurement). Press the *Remove All* (F3) key to OFF all channels on Slot 1 module from Scan Status, which indicates that measurements of all channels on the module can now be configured to the Switch mode.

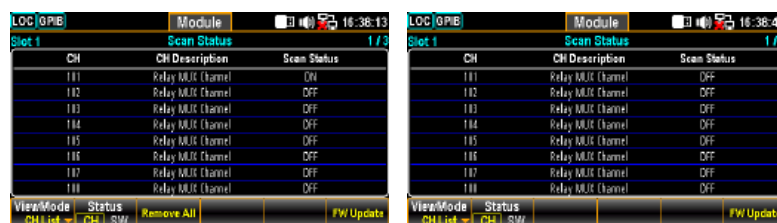

- Press the *Channel* key from the front panel. It is seen that the *Measure* is OFF for the channel 101 and the *Switch* key and *JoinBank* key are available for On or Off by user.



- Switch:
To enable or disable switch for each channel.
- JoinBank:
To enable or disable multiple banks join of a module.

- If user reselects a measurement from the Measure key (TEMP in the instance), the channel 101 will return to Scan Status On and both the *Switch* key and *JoinBank* key are no longer available.

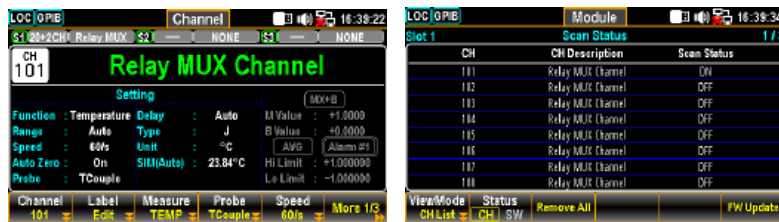

Display

- The figure below shows both Switch and JoinBank are turned ON for the channel 101 of the Slot 1 module.

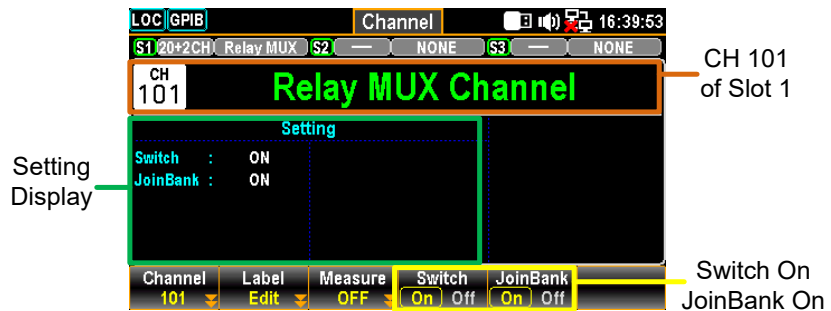

Note

When enabling JoinBank function on any of the channels, the JoinBank of all channels from the same module will be turned ON simultaneously.

Computer Channels

Background Computer channels (401 – 420) can execute various mathematical operations from readings of measurement channels or other computer channels.



Note

- To execute mathematical operations in computer channels, it is required to set up measurement channels beforehand.
- Computer channels are not able to be monitored readings in the Monitor mode. However, it is able to monitor readings of computer channels when the Scan mode is performed.

Types The mathematical operations of computer channels can be divided into mainly three types as following:

Type	Soft key	Description
Basic Math	A + B	Addition
	A – B	Subtraction
	A * B	Multiplication
	A / B	Division
	1 / A	Reciprocal
	A * A	Power
Statistics	Sqrt(A)	Square root
	AVG(List)	Calculates the average readings from a list of selected channels, where average reading = total sum of all the readings/number of selected channels
	MIN(List)	Calculates the minimum reading from a list of selected channels
	MAX(List)	Calculates the maximum reading from a list of selected channels
	SDEV(List)	Calculates the standard deviation readings from a list of selected channels
Polynomial 5TH(A)		Polynomial 5TH

Basic Math

Description An example of mathematical operation $A + B$ on the channel 401 will be illustrated below.

- Steps**
1. From the example below in the Channel menu, the *Computer* (F3) key is turned On and the *Formula* (F4) key is configured $A + B$. Also, press the *CH A* (F5) and the *CH B* (F6) keys to specify source channels as 201 and 202, individually.

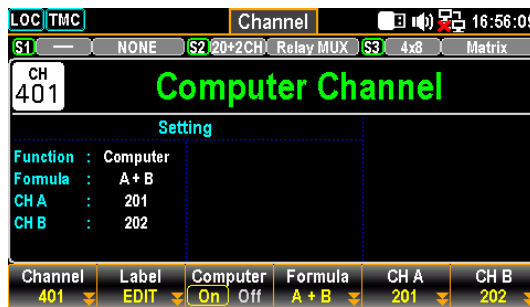

 **Note**

The source channels of CH A and CH B can be an identical one. For instance, it is available to specify both as 201 channel.

2. Launch a scan course by pressing the *Scan* key from the front panel followed by clicking the *View* key from the front panel and the scan result is displayed here.

CH401 (+0.154744) =
 CH201 (077.1446) + CH202 (077.6001)

Date	Time	CH	CH Label	Reading
2022/09/16	16:00:54.239	201	Relay MUX ChannelD	077.1446 mVAC
2022/09/16	16:00:55.311	202	Relay MUX Channel	077.6001 mVAC
2022/09/16	16:00:55.311	401	Computer Channel	+0.154744

Statistics

Description An example of mathematical operation AVF(List) on the channel 401 will be illustrated below.

- Steps**
1. From the example below in the Channel menu, the *Computer* (F3) key is turned On and the *Formula* (F4) key is configured AVG(List). Also, press the *CH List* (F5) key to enter the channel list edit.

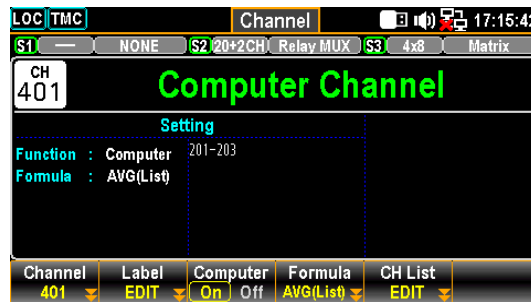

2. Use *knob* key to navigate channels. Press the *Select* (F5) key to select a channel followed by press the OK (F4) key to confirm all selections. If a channel is selected, press the *Cancel* (F5) key to deselect a channel or press the *Clear All* (F3) key to deselect all channels. Press the *Exit* (F6) key to leave without saving.



3. Launch a scan course by pressing the *Scan* key from the front panel followed by clicking the *View* key from the front panel and the scan result is displayed here.

$$\text{CH401 (+078.2949)} =$$

$$[\text{CH201 (078.0570)} + \text{CH202 (078.4820)} + \text{CH203 (078.3456)}] / 3$$

Date	Time	CH	CH Label	Reading
2022/09/16	17:28:45.042	201	Relay MUX ChannelD	078.0570 mVAC
2022/09/16	17:28:46.113	202	Relay MUX Channel	078.4820 mVAC
2022/09/16	17:28:47.185	203	Relay MUX Channel	078.3456 mVAC
2022/09/16	17:28:47.185	401	Computer Channel	+078.2949 m

Polynomial 5TH

Description An example of mathematical operation 5TH(A) on the channel 401 will be illustrated below.

- Steps**
1. From the example below in the Channel menu, the *Computer* (F3) key is turned On and the *Formula* (F4) key is configured 5TH(A). Press the *CH A* (F5) key to specify source channels as 201 followed by pressing the *More 1/2* (F6) key to enter the next page.

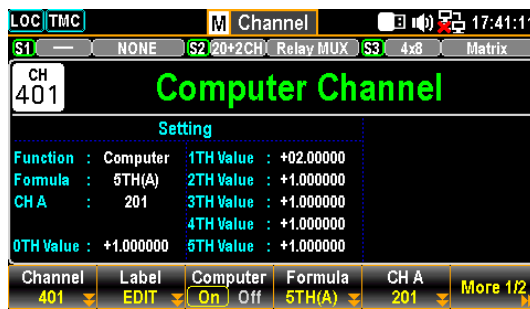

2. Press the $(x)TH$ (F1) key to select a coefficient order (0TH, 1TH, 2TH, 3TH, 4TH, 5TH) followed by pressing the *TH Value* (F2) key to configure parameters for each coefficient order.

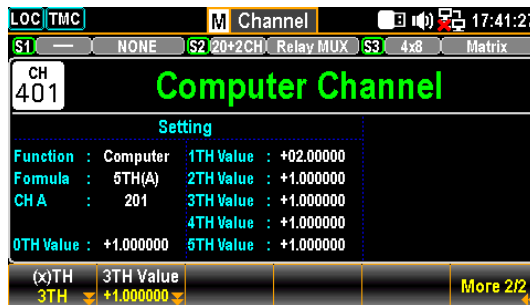

3. Launch a scan course by pressing the *Scan* key from the front panel followed by clicking the *View* key from the front panel and the scan result is displayed here.

CH401 (+1.085099) =

The polynomial 5TH order from CH201 (078.8081)

Date	Time	CH	CH Label	Reading
2022/09/16	17:50:24.098	201	Relay MUX ChannelD	078.8081 mVAC
2022/09/16	17:50:24.325	202	Relay MUX Channel	078.8081 mVAC
2022/09/16	17:50:24.555	203	Relay MUX Channel	078.8664 mVAC
2022/09/16	17:50:24.555	401	Computer Channel	+1.085550

Interval Menu

Background Press the *Interval* key on the front panel to enter the Interval menu to configure the method to start each sweep and a total number of sweeps for a scan course. The screen layout of Interval menu is almost identical to that of Home screen and is only different in the function keys.



F1 (TrigSource) key to select a trigger source method **Auto** It indicates an immediate trigger, which means each sweep starts automatically when a scan course begins.



Time It indicates a timer to start each sweep at a designated interval. Press the *Time* (F2) key to configure the interval for this method.



During a scan course, each sweep only starts when the set timer completes countdown.

Next sweep waits until countdown by set timer

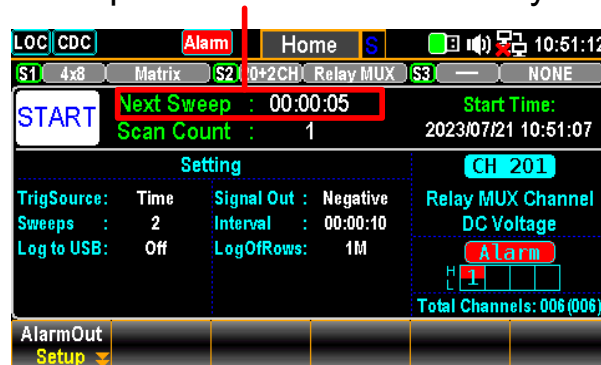

Manual It indicates a manual trigger. When selecting this method, user needs to press the *Scan* key on the front panel to start each sweep for a scan course.

TrigSource	Sweeps	Sweeps INF	Signal Out
Manual	3	On (Off)	Pos (Neg)

During a scan course, each sweep only starts when user presses the *Scan* key.

Next sweep waits until Scan Key by user

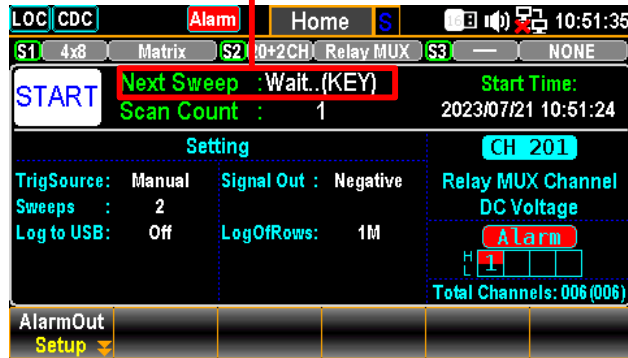

External It indicates a trigger signal received from the rear panel to start each sweep for a scan course. Press the *TrigSignal* (F2) key to configure the polarity of external signal in either Pos or Neg.

TrigSource	TrigSignal	Sweeps	Sweeps INF	Signal Out
External	Pos (Neg)	3	On (Off)	Pos (Neg)

During a scan course, each sweep only starts when an External signal is received.

Next sweep waits until External signal

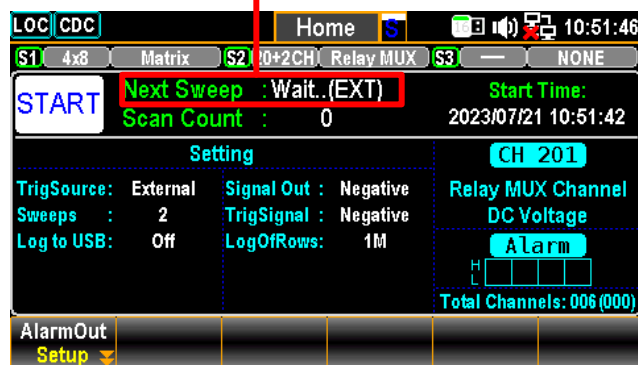

On Alarm It indicates a sweep starts when an alarm is detected from the set channel. Press the *On Alarm* (F2) key to specify which alarm (1-4) is used to report on the select channel.



During a scan course, each sweep only starts when an designated Alarm is detected

Next sweep waits until set Alarm detected

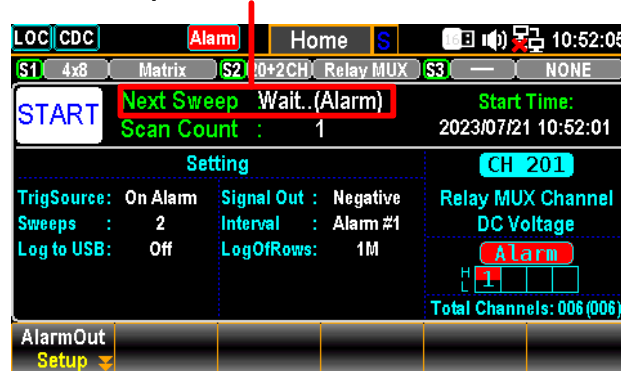

F2 (Time) key When Time of TrigSource is selected, press the key to specify a to set interval time interval.

F2 (TrigSignal) key When External of TrigSource is selected, press the key to configure the polarity of external signal in either Pos or Neg. the polarity

F2 (On Alarm) key When On Alarm of TrigSource is selected, press the key to specify which alarm (#1 - #4) is used to report on the select channel.

F3 (Sweeps) key It specifies a total number of times of sweeps that DAQ-9600 will run through a scan course. specify number

F4 (Sweeps INF) key It configures that DAQ-9600 will execute a scan course indefinitely until user stop scan course via long pressing the *Scan* key on the front panel. set INF sweeps

F6 (Signal Out) key It configures either Pos or Neg polarity will be used as signal out on the rear panel. set polarity

Edit Menu

Background Press the *Edit* key on the front panel to enter the Edit menu in which user is able to copy measurement functions, alarm settings and so on from channels to channels with ease.



Edit Menu Diagram

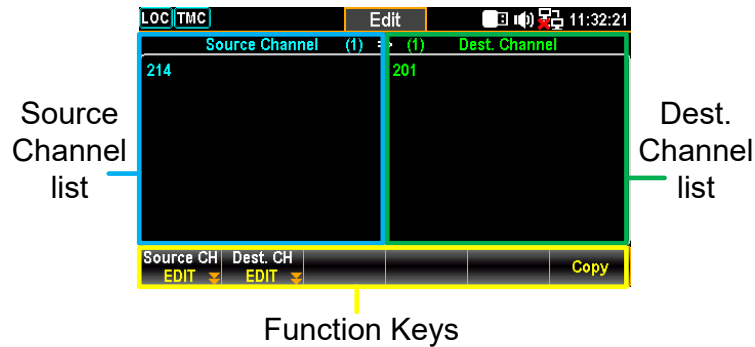

Source Channel The channels selected as source are displayed in detail within the lower list section and the upper section indicates the total number of source channels selected.

Dest. Channel The channels selected as destination are displayed in detail within the lower list section and the upper section indicates the total number of destination channels selected.

Function Keys The function keys here are simple. Press *Source CH* (F1) key to select source channel(s) and press *Dest. CH* (F2) key to select destination channel(s) followed by pressing *Copy* (F6) key to perform the action of channel copying.



Source channel(s) must be configured with measurement function beforehand.

Copy Channels

Description Channel(s) copying can be performed in various ways: one-to-one, one-to-many and many-to-many. In this chapter an example of many-to-many channels copying is illustrated.

- Steps**
1. Press the *Edit* key on the front panel to enter the Edit menu followed by pressing the *Source CH* (F1) key to edit the Source Channel Select list.



2. Use *knob key* to navigate channels followed by pressing *Select* or *Select All* to select source channels. Press *Cancel* or *Clear All* to deselect channels. Press *OK* to confirm selection. Press *Exit* to leave the page without saving the selection.

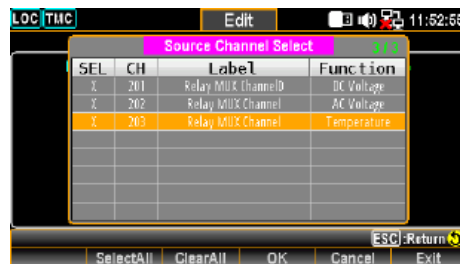

Only the channels with measurement functions are displayed in the Source Channel Select list since source channel(s) must be configured with measurement beforehand.

3. After pressing *OK* key from the previous page, the selected channels are displayed within the left part (201 – 203 for example). Further press the *Dest. CH* (F2) key to edit list of Dest. Channel Select.

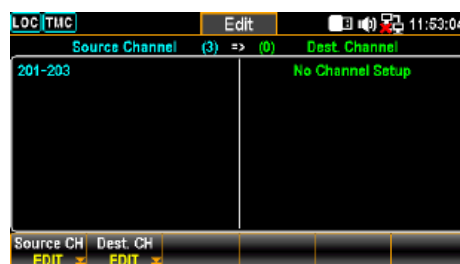

- Use *knob* key to navigate channels followed by pressing *Select* or *Select.All* to select destination channels. Press *Cancel* or *Clear.All* to deselect channels. Press *OK* to confirm selection. Press *Exit* to leave the page without saving the selection.



Note

Those selected as source channels previously will not displayed here within the Dest. Channel Select list.

- After pressing *OK* key from the previous page, the selected channels are displayed within the right part (206 – 208 for example). Further press the *Copy* (F6) key to perform channels copying action.

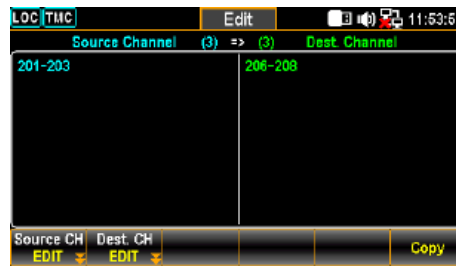

- The configurations of channels 201 – 203 are well copied to the channels 209 through 211. It is seen that the prompt message of “3 channels copied” is shown in display.



Note

The Computer channels (401 – 420) are not available for channels copying operations.

Alarm Menu

Background Press the *Alarm* key on the front panel to enter the Alarm menu to configure the conditions of triggered alarm for select channels. The screen layout of Alarm menu is almost identical to that of Channel menu and is only different in the function keys.



Alarm Menu Diagram

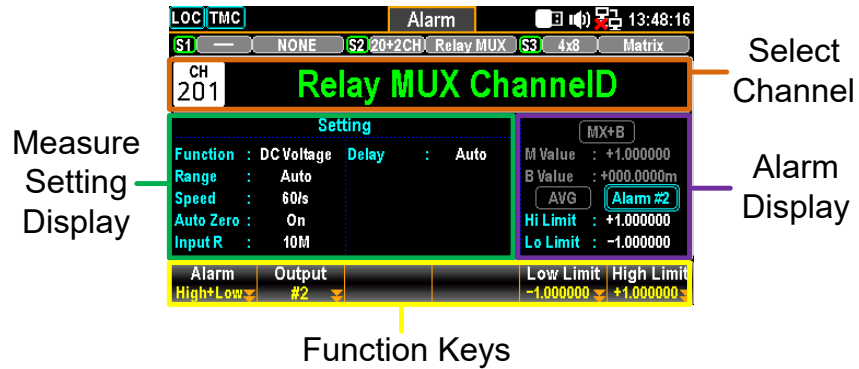

- Select Display** It indicates the current selected channel
- Measure Setting Display** It indicates the parameters settings of the current selected channel.
- Alarm Display** Alarm Hi & Lo limits settings for selected channel are displayed. Press the *knob* key to toggle between AVG and Alarm setting display.
- Function Keys** The operable function keys of Alarm menu.

Alarm Configuration

Description This section demonstrates how to configure alarm conditions for each selected channels.

- Steps**
1. Press the *Alarm* key on the front panel to enter the Alarm menu and use the *knob* key to navigate channels to select a target one (channel 201 for example below).

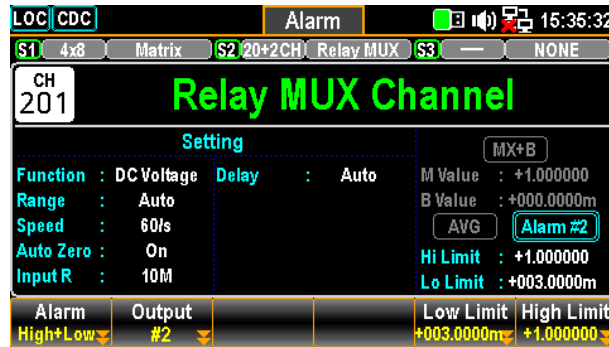

2. Press the *Alarm* (F1) key to select an alarm limit(s) mode to report for select channel.



OFF Alarm condition is disabled for select channel.

High+Low Both High and Low limits of Alarm condition are activated.

High High limit of Alarm condition is activated.

Low Low limit of Alarm condition is activated.

3. Press the *Output* (F2) key to select which of the four alarms will be utilized to report alarm conditions for select channel.



4. Press the *Low Limit* (F5) and the *High Limit* (F6) keys to specify alarm limits individually for select channel.

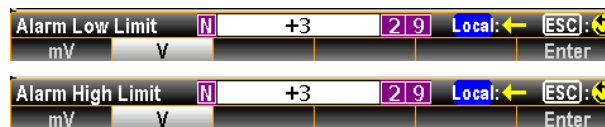

5. Press the *Scan* key on the front panel to initiate a scan course. When the set alarm occurs for select channel during a scan course, the alarm status will be shown clearly as the following example.

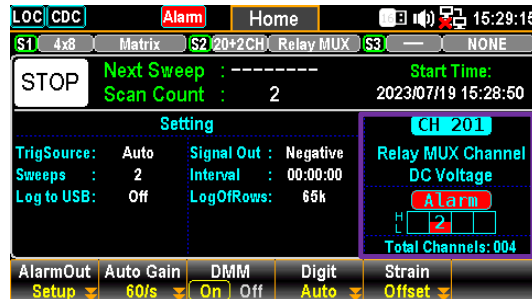

The set low limit of alarm #2 is triggered

6. Also, the alarm details will be saved in the memory when the set alarm occurs for select channel during a scan course. Press the *View* key on the front panel to view the info of triggered alarm. Refer to page 105 for details of View menu.

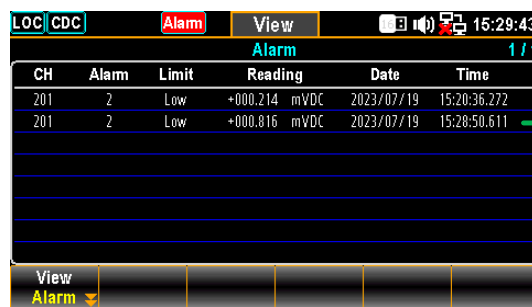

The details of alarm #2 for channel 201 is well displayed

Alarm in Monitor mode Under the Monitor mode, if set limit of alarm is exceeded, the color of reading becomes warning red in different display modes.

Number display

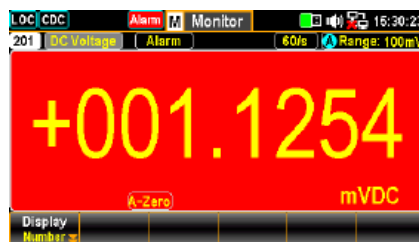

Bar display

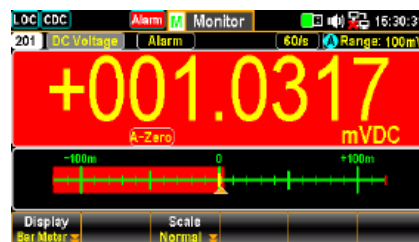

Trend display

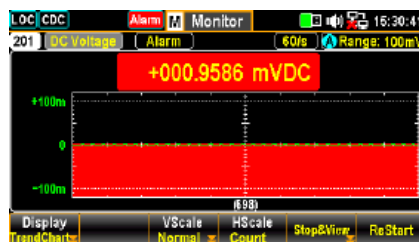

Histogram display

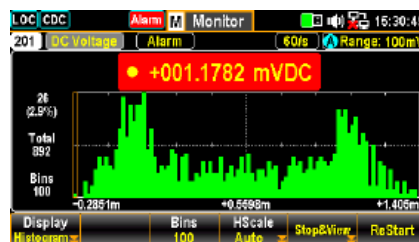

View Menu

Background Press the *View* key on the front panel to enter the View menu where several relevant info after scanned measurement including Data, Alarm, Error and Relay Cycle are displayed for user to have better understanding of measured info by a scan course.

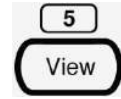

Data View

Background This section introduces view menu for measured scan Data, which can be viewed in various displays including List, Statistics, TrendChart and Histogram.

List Display

- Steps**
1. Press the *View* (F1) key followed by pressing the *Data* (F1) key. And then press the *Display* (F2) key followed by selecting the *List* (F1) key to enter the page of scanned data in List display.

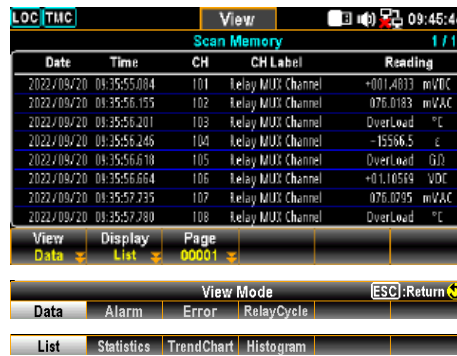

2. Press the *Page* (F3) key to jump to each page of measured data or it is available to use the *knob* key to navigate through pages conveniently.

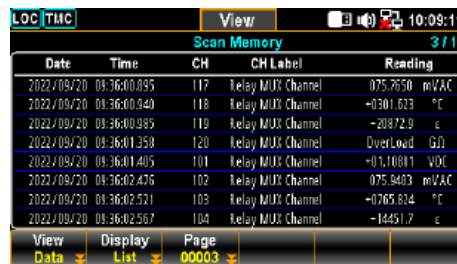

- The list mode displays Date, Time, Channel, Channel Label (naming by user) and reading of each measured data from a scan course.

Date	Time	CH	CH Label	Reading
2022/09/20	09:36:00.895	117	Relay MUX Channel	075.7650 mVAC
2022/09/20	09:36:00.940	118	Relay MUX Channel	+0301.623 °C
2022/09/20	09:36:00.985	119	Relay MUX Channel	-20872.9 ε
2022/09/20	09:36:01.358	120	Relay MUX Channel	OverLoad GΩ
2022/09/20	09:36:01.405	101	Relay MUX Channel	+01.10001 VDC
2022/09/20	09:36:02.476	102	Relay MUX Channel	075.9483 mVAC
2022/09/20	09:36:02.521	103	Relay MUX Channel	+0765.824 °C
2022/09/20	09:36:02.567	104	Relay MUX Channel	-14451.7 ε

Statistics Display

Steps

- Press the *View* (F1) key followed by pressing the *Data* (F1) key. And then press the *Display* (F2) key followed by selecting the *Statistics* (F2) key to enter the page of scanned data in Statistics display.

CH	Min	Max	Pk-Pk	Average	STDEV
117	076.6183m	176.9840m	010.3657m	+076.7654m	+0.157104m
118	+0437.270	OverLoad	OverLoad	OverLoad	OverLoad
119	-19048.3	-2340.2	+11689.1	-0.100012s	+05.52115m
120	0.248411G	1.256469G	0.000057G	+0.251520G	+02.48970M

- Use the *knob* key to navigate through pages conveniently.

CH	Min	Max	Pk-Pk	Average	STDEV
101	+01.09016	+01.10590	+10.00773	+1.100036	+02.56139m
102	076.7440m	176.9100m	010.1660m	+076.1079m	+050.7141μ
103	+0206.893	OverLoad	OverLoad	OverLoad	OverLoad
104	-2205.05	-4925.4	+17125.0	-0.100013s	+05.40313m
105	0.248660G	1.258146G	0.000486G	+0.251459G	+03.34241M
106	+1.085787	+1.101235	+1.005407	+1.098660	+02.08932m
107	077.0105m	177.4177m	010.4071m	+077.2186m	+0.123457m
108	OverLoad	OverLoad	OverLoad	OverLoad	OverLoad

- The statistics mode displays Channel, Minimum, Maximum, Pk-Pk (Peak-to-Peak), Average and STDEV (Standard Deviation) of readings data from a scan course.

CH	Min	Max	Pk-Pk	Average	STDEV
101	+01.09816	+01.10590	+00.00773	+1.100036	+02.56039m
102	076.7440m	076.9100m	000.1660m	+076.8079m	+059.7141µ
103	+0206.993	OverLoad	OverLoad	OverLoad	OverLoad
104	-22050.5	-4925.4	+17125.0	-0.000013k	+05.40913m
105	0.249660G	0.250146G	0.008486G	+0.253459G	+03.14241M
106	+1.095787	+1.101235	+0.005447	+1.098660	+02.09592m
107	077.0105m	077.4177m	000.4071m	+077.2196m	+0.123452m
108	OverLoad	OverLoad	OverLoad	OverLoad	OverLoad

- Press the *Mode* (F3) key to toggle between STAT (Statistics) and TIM (Time Stamp) displays. The TIM mode displays the Date & Time of Minimum and Maximum readings of each channel from a scan course.

CH	Timestamp of Min		Timestamp of Max	
101	2022/09/20	11:10:48.638	2022/09/20	11:10:41.247
102	2022/09/20	11:10:45.664	2022/09/20	11:10:53.056
103	2022/09/20	11:10:56.797	2022/09/20	11:10:45.709
104	2022/09/20	11:10:56.843	2022/09/20	11:10:53.147
105	2022/09/20	11:10:53.212	2022/09/20	11:10:42.125
106	2022/09/20	11:10:42.170	2022/09/20	11:10:53.257
107	2022/09/20	11:10:57.676	2022/09/20	11:10:46.587
108	2022/09/20	11:10:42.938	2022/09/20	11:10:42.938

Trend Chart Display

Steps

- Press the *View* (F1) key followed by pressing the *Data* (F1) key. And then press the *Display* (F2) key followed by selecting the *TrendChart* (F3) key to enter the page of scanned data in Trend Chart display.

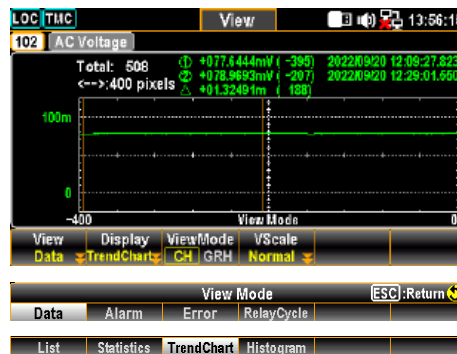

- When the “CH” is selected for *ViewMode* (F3) key, scroll the *knob* key to navigate through channels.

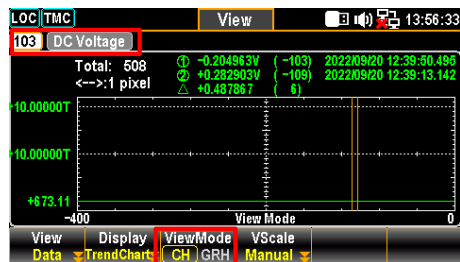

- When the “GRH” is selected for *ViewMode* (F3) key, scroll the *knob* key to navigate through scanned counts. If pressing *knob* key, the maximum counts moving by scrolling *knob* key per time will be changed.

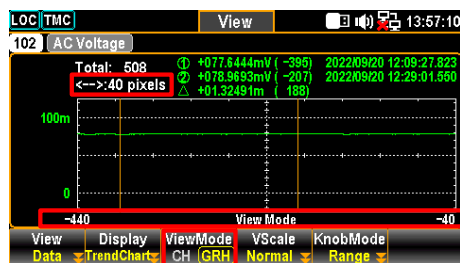

Pixels options: 1 pixel – 40 pixels – 400 pixels

F4 (Vscale) key to edit scale ranges

- VScale - Normal:
It allows the vertical scale of trend chart to be symmetric with the set range for channel.

The symmetric vertical scale with set range

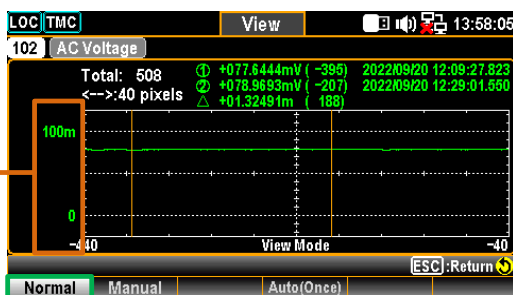

Normal for VScale

- VScale - Manual:
It allows the vertical scale of trend chart to be customized in the following 2 ways.

L & H for Manual

After L and H are set up individually, the vertical upper and lower ranges are corresponding to the set values accordingly.

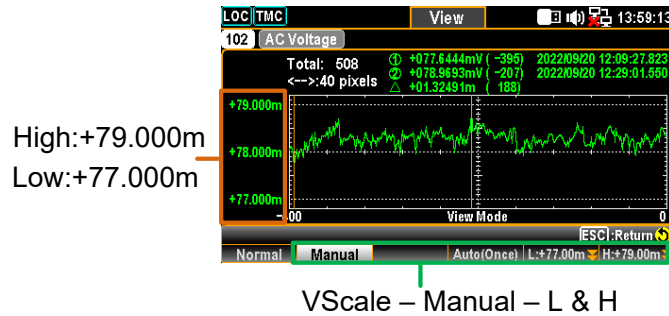

Auto(Once) for Manual

After Auto(Once) is pressed, the vertical upper and lower ranges are automatically defined in accord with the latest 400 counts of scanned data.

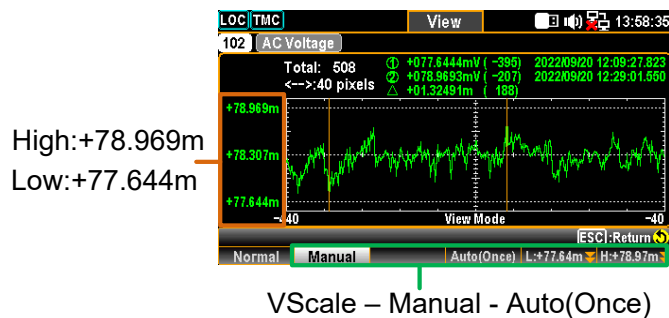

F5
(KnobMode)
key to view in
details

- KnobMode - Range:
It allows user to view detailed info on the trend chart.
Press *Range* key followed by scrolling *knob* key rightward or leftward to move cursors on different sections.

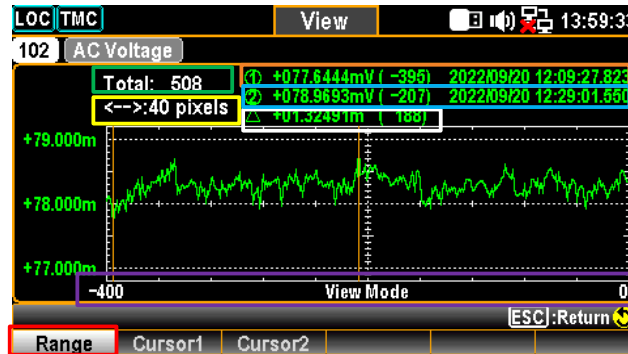

Green Sect. The total counts of scanned measurements.

Yellow Sect. Press the *knob* key to change the maximum counts moving by scrolling *knob* key per time.
1 pixel – 40 pixels – 400 pixels

Orange Sect. The lowest value of the selected count with its affiliated serial number and time stamp.

Blue Sect. The highest value of the selected count with its affiliated serial number and time stamp.

White Sect. The delta between the highest and lowest values of the selected count with its affiliated serial number.

Purple Sect. The horizontal scale of measurements displayed is fixed in the 400 counts

Red Sect. It indicates the counts of moving range by scrolling *knob* key rightward or leftward to different section per time. Based on the Yellow Sect., when 400 pixels is defined, scroll the *Knob* key once, the scale increases or decreases 400 counts per time.

- KnobMode – Cursor 1 & Cursor 2:
 It allows user to view the lowest and highest readings of each count on the trend chart. Press the *Cursor1* (F2) or *Cursor2* (F3) key followed by scrolling *knob* key rightward or leftward to move cursors on different sections.

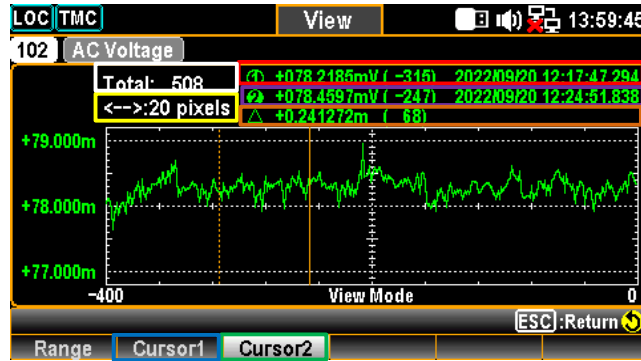

- White Sect. The total counts of scanned measurements.
- Green Sect. Press the *Cursor1* for checking the lowest value of each count.
- Blue Sect. Press the *Cursor2* for checking the highest value of each count.
- Red Sect. The lowest value of the selected count with its affiliated serial number and time stamp.
- Purple Sect. The highest value of the selected count with its affiliated serial number and time stamp.
- Yellow Sect. Press the *knob* key to change the maximum counts moving by scrolling *knob* key per time.
 1 pixel – 10 pixels – 20 pixels
- Orange Sect. The delta between the highest and lowest values of the selected count with its affiliated serial number.

Histogram Display

Steps

1. Press the *View* (F1) key followed by pressing the *Data* (F1) key. And then press the *Display* (F2) key followed by selecting the *Histogram* (F4) key to enter the page of scanned data in Histogram display.

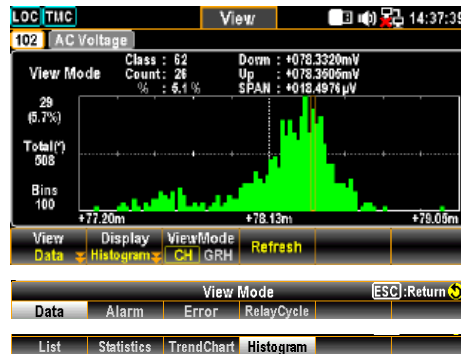

2. When the “CH” is selected for *ViewMode* (F3) key, scroll the *knob* key to navigate through channels.

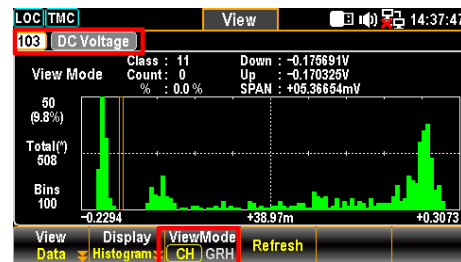

3. When the “GRH” is selected for *ViewMode* (F3) key, scroll the *knob* key to navigate through each scanned count.

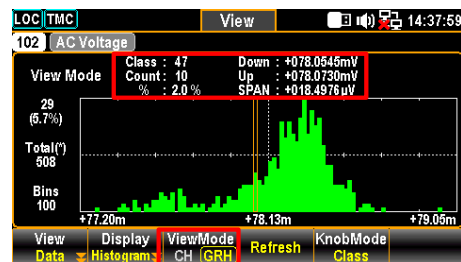

4. Due to readings are not updated with the live scan in histogram display, press the *Refresh* (F4) key to update live readings when a scan course is ongoing.

Alarm View

Description This section introduces view menu for Alarms. Only when alarm setting is configured beforehand for select channel, the alarm list will display details of channel, limit, reading and time stamp of the latest 40 alarms. Refer to page 102 for details of how to configure alarms. After user reads the Alarm list here, the whole Alarm list will be cleared.

- Steps**
1. Press the *View* (F1) key followed by pressing the *Alarm* (F2) key. And the Alarm list page shows the latest alarms in details.

CH	Alarm	Limit	Reading	Date	Time
301	1	High	+024.2403 mVDC	2022/09/20	17:17:19.710
303	3	High	+025.9138 mVDC	2022/09/20	17:17:19.898
304	3	Low	+024.3818 mVDC	2022/09/20	17:17:19.992
302	2	Low	+024.1251 mVDC	2022/09/20	17:17:31.096
304	3	Low	+024.2651 mVDC	2022/09/20	17:17:35.040
302	2	Low	+024.1899 mVDC	2022/09/20	17:17:44.271
304	3	Low	+024.0750 mVDC	2022/09/20	17:17:48.224
302	2	Low	+024.2878 mVDC	2022/09/20	17:17:57.446

2. Use the *knob* key to navigate through pages to have view on more alarms from different pages.

CH	Alarm	Limit	Reading	Date	Time
304	3	Low	+024.5109 mVDC	2022/09/20	17:18:05.163
302	2	Low	+024.7792 mVDC	2022/09/20	17:18:44.498
304	3	Low	+024.4088 mVDC	2022/09/20	17:18:52.214
302	2	Low	+024.4021 mVDC	2022/09/20	17:19:00.965
304	3	Low	+024.0314 mVDC	2022/09/20	17:19:14.000

Error View

Description This section introduces view menu for Errors. The Error list displays Code and String of the latest 20 errors. After user reads the Error list here, the ERR icon on the top status bar will be erased and the whole Error list will be cleared.

- Steps**
1. Press the *View* (F1) key followed by pressing the *Error* (F3) key. And the Error list page shows the latest errors in details.

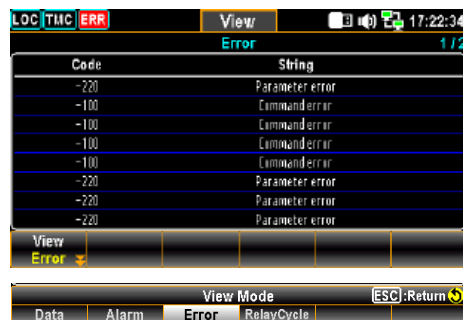

2. Use the *knob* key to navigate through pages to have view on more errors from different pages.

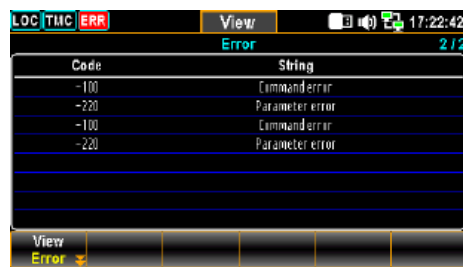

Relay Cycle View

Description This section introduces view menu for Relay Cycle of each channel from the installed module. It empowers user to track if any relay failures or to figure out requirements of maintenance.

- Steps**
1. Press the *View* (F1) key followed by pressing the *RelayCycle* (F4) key. And the Relay Cycles list page displays the number of cycles on each relay from the installed modules.

The screenshot shows the 'Relay Cycles' menu on a device. At the top, it says 'LOC TMC' and 'View'. The title is 'Relay Cycles' with a page indicator '1 / 3'. Below is a table with three columns: 'CH', 'CH Description', and 'User Cycles'. The table lists channels 301 through 308, all described as 'Solid-State MUX Channel'. At the bottom, there are navigation options for 'Slot 1', 'Slot 2', and 'Slot 3', and a 'View Mode' section with options for 'Data', 'Alarm', 'Error', and 'RelayCycle'.

CH	CH Description	User Cycles
301	Solid-State MUX Channel	13401589
302	Solid-State MUX Channel	13401705
303	Solid-State MUX Channel	13401551
304	Solid-State MUX Channel	13401534
305	Solid-State MUX Channel	13401540
306	Solid-State MUX Channel	13400917
307	Solid-State MUX Channel	13400906
308	Solid-State MUX Channel	13400900

2. Use the *knob* key to navigate through pages to have view on the number of cycles of each relay from different channels.

The screenshot shows the 'Relay Cycles' menu on a device, displaying a second page of data. At the top, it says 'LOC TMC' and 'View'. The title is 'Relay Cycles' with a page indicator '2 / 3'. Below is a table with three columns: 'CH', 'CH Description', and 'User Cycles'. The table lists channels 309 through 316, all described as 'Solid-State MUX Channel'. At the bottom, there are navigation options for 'Slot 1', 'Slot 2', and 'Slot 3', and a 'View Mode' section with options for 'Data', 'Alarm', 'Error', and 'RelayCycle'.

CH	CH Description	User Cycles
309	Solid-State MUX Channel	13400890
310	Solid-State MUX Channel	13400807
311	Solid-State MUX Channel	13400465
312	Solid-State MUX Channel	13400430
313	Solid-State MUX Channel	13400422
314	Solid-State MUX Channel	13400414
315	Solid-State MUX Channel	13400409
316	Solid-State MUX Channel	13400399

Module Menu

Background Press the *Module* key on the front panel to enter the Module menu where user can view circuit diagrams of installed modules, check both scan and switch status of channels from installed modules and proceed to firmware update for installed modules.

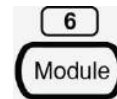

- Steps**
1. After pressing the *Module* key on the front panel, the circuit diagram of installed module is displayed. Scroll the *knob* key to navigate through installed modules to select a target module.

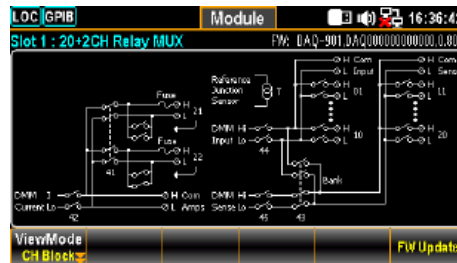

2. Press the *ViewMode* (F1) key followed by pressing the *CH List* (F2) key. And the Scan Status of all channels from select module will be shown. Scroll the *knob* key to navigate through pages of different channels. Press *Remove All* (F3) key to remove the set measurements of all channels at once. Refer to page 54 for details of Switch mode.

CH	CH Description	Scan Status
101	Relay MUX Channel	OFF
102	Relay MUX Channel	DN
103	Relay MUX Channel	OFF
104	Relay MUX Channel	DN
105	Relay MUX Channel	OFF
106	Relay MUX Channel	DN
107	Relay MUX Channel	OFF
108	Relay MUX Channel	DN

- If any channel is set Switch mode, press the *Status* (F2) key to select SW followed by pressing the *Card Reset* (F3) key to reset the select module. All channels on the module will be opened. Refer to page 88 for details of Switch mode.

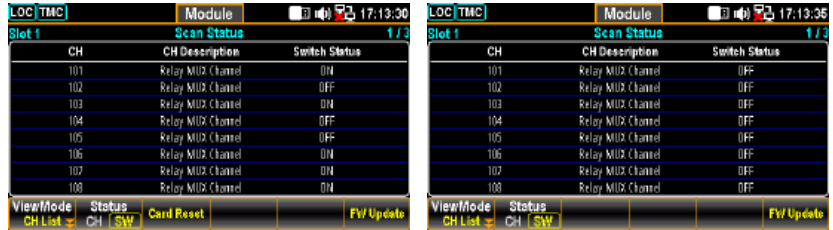

- When user intends to carry out firmware update for installed module, press the *FW Update* (F6) key to perform update process. The prompt message pops up and user can press *Yes* (F1) to carry on the update.

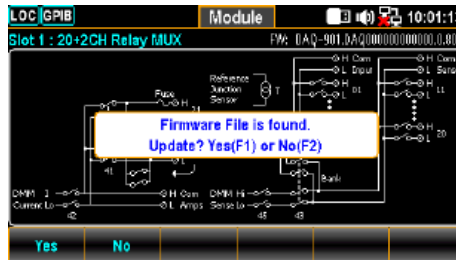

Note

- Connect an USB disk containing compatible module firmware file to the USB host port on front panel of DAQ-9600 before proceeding to FW Update for the installed module.
- Prior to update, please rename and confirm the downloaded firmware files as below:
 - ✓ C_IMAGE.bin

Math Menu

Background Press the *Math* key on the front panel to enter the Math menu. Math measurement runs 5 types of mathematical equations, dB, dBm, MX+B, 1/X and Percent, based on the measurement results of each channel.

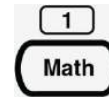

Math Equation	Equation	Description
	dBm	$10 \times \log_{10} (1000 \times V_{\text{reading}}^2 / R_{\text{ref}})$
	dB	dBm – dBmref
	MX+B	Multiplies the reading (X) by the factor (M) and adds/subtracts offset (B).
	1/X	Divides 1 by the reading (X).
	Percentage	$\frac{(\text{ReadingX} - \text{Reference})}{\text{Reference}} \times 100\%$



Note

- User needs to configure channel measurement before setting up the Math equations.
- If the measurement of channel is changed (from ACV to DCV for example), Math function will be Off. Reconfigure Math function after changing measurement.
- dBm and dB equations are available on channels set in DCV and ACV measurements only.

dBm Measurement

Math Equation $10 \times \log_{10} (1000 \times V_{\text{reading}}^2 / R_{\text{ref}})$

F1 (Function) key to select dBm equation



F3 (REF Ω) key to select reference resistance Press the key to enter the menu to change the reference resistance, which indicates reference resistance simulating an output load.



F2 (MathDisp) key to select display modes Press the key to show the MathDisp menu for 4 different displays. See the following descriptions for details.



Note

Only when Alarm configuration is enabled can the “Alarm” and “ALR+STAT” of Math Display are available to activate.

Show STAT Result

Description The STAT page in MathDisp allows user to make statistical calculations for measurements including Minimum, Maximum, Average Peak-Peak, Standard Deviation and Count.

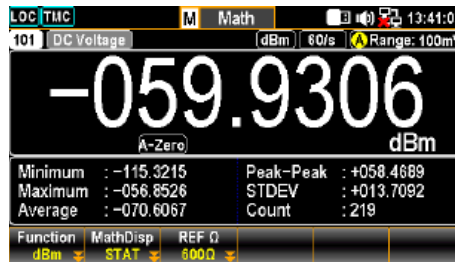

Values	-059.9306 dBm	Indicates the latest dBm value
	Minimum	Indicates the minimum value
	Maximum	Indicates the maximum value
	Average	Indicates the average value
	Peak-Peak	Indicates the peak to peak value
	STDEV	Indicates the standard deviation value
	Count	Indicates the latest counts of dBm

Show Math Result

Description The Math page in MathDisp allows user to view mathematical calculations for several parameters.

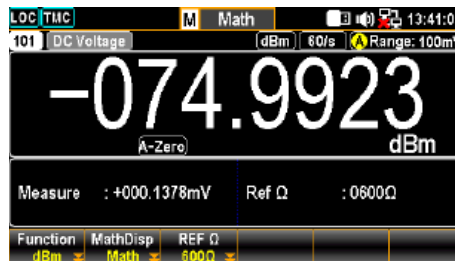

Values	-074.9923 dBm	Indicates the latest dBm value
	Measure	Indicates the originally measured Voltage value
	RefΩ	Indicates the defined ref Ω value

Show Alarm Result

Description The Alarm page in MathDisp allows user to track if measured data exceeds the set High and Low limits, individually.



Values	Low Limit	Indicates the set low limit of channel
	High Limit	Indicates the set high limit of channel
	Low Fail	Indicates the numbers of low limit exceeding
	High Fail	Indicates the numbers of high limit exceeding

Show ALR+STAT Result

Description The ALR+STAT page in MathDisp allows user to view information from both STAT and Alarm pages simultaneously.

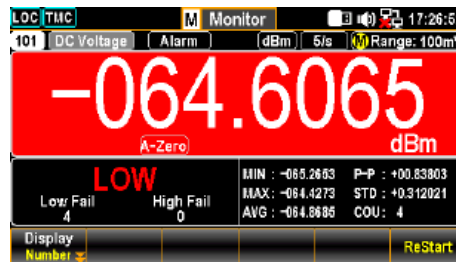

Values	Left Sec.	The numbers of High and Low limits exceeding are shown individually.
	Right Sec.	The values, which based on dBm calculation, identical to STAT page are well displayed.



Note

Only when Alarm configuration is enabled can the “Alarm” and “ALR+STAT” of Math Display are available to activate. Refer to page 102 for details of Alarm.

dB Measurement

Math Equation dBm – dBmref

F1 (Function) dB
key to select dB
equation



F3 (REF Ω) key to select reference resistance Press the key to enter the menu to change the reference resistance, which indicates reference resistance simulating an output load.



F4 (Ref Method) key select dB reference method Press the key to enter the Reference method menu which involves the 2 ways to calculate dB value. When dBm option is selected, user can specify a definite dBm value for dB calculation. If selecting Voltage option, system regards the defined voltage value as the Vreading parameter for dBm calculation, thus resulting in different dB value than the previous option.



F5 (Ref Value) to define reference value (voltage or dBm) In order to define either voltage or dBm reference value, both of which are corresponding to the previous F4 (Ref Method) option, press the key to enter the Ref Value menu to configure either voltage or dBm reference value.



F6 (Ref Value) key to get value at once Press the key to instantly make the current dBm value, which is calculated by the current input voltage with the equation, as the Ref dBm (dBm reference).



F2 (MathDisp) key to select display modes Press the key to show the MathDisp menu for 4 different displays. See the following descriptions for details.



Note

Only when Alarm configuration is enabled can the “Alarm” and “ALR+STAT” of Math Display are available to activate.

Show STAT Result

Description The STAT page in MathDisp allows user to make statistical calculations for measurements including Minimum, Maximum, Average Peak-Peak, Standard Deviation and Count.

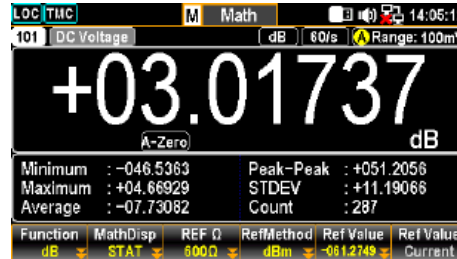

Values	+03.01737 dB	Indicates the latest dB value
	Minimum	Indicates the minimum value
	Maximum	Indicates the maximum value
	Average	Indicates the average value
	Peak-Peak	Indicates the peak to peak value
	STDEV	Indicates the standard deviation value
	Count	Indicates the latest counts of dB

Show Math Result

Description The Math page in MathDisp allows user to view mathematical calculations for several parameters.

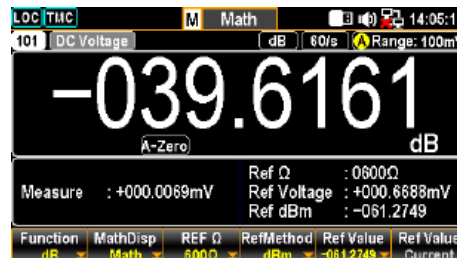

Values	-039.6161 dB	Indicates the latest dB value
	Measure	Indicates the originally measured Voltage value
	RefΩ	Indicates the defined ref Ω value
	Ref Voltage	Indicates the measured reference voltage value
	Ref dBm	Indicates the measured reference dBm value

Show Alarm Result **Description** The Alarm page in MathDisp allows user to track if measured data exceeds the set High and Low limits, individually.



Values	Low Limit	Indicates the set low limit of channel
	High Limit	Indicates the set high limit of channel
	Low Fail	Indicates the numbers of low limit exceeding
	High Fail	Indicates the numbers of high limit exceeding

Show ALR+STAT Result **Description** The ALR+STAT page in MathDisp allows user to view information from both STAT and Alarm pages simultaneously.

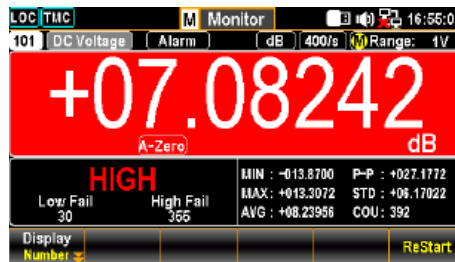

Values	Left Sec.	The numbers of High and Low limits exceeding are shown individually.
	Right Sec.	The values, which based on dB calculation, identical to STAT page are well displayed.



Note

Only when Alarm configuration is enabled can the “Alarm” and “ALR+STAT” of Math Display are available to activate. Refer to page 102 for details of Alarm.

MX+B Measurement

Math Equation Multiplies the reading (X) by the factor (M) and adds/subtracts offset (B).

F1 (Function) MX+B

key to select
MX+B equation



F3 (M Value) key Press the key to enter the menu to configure a M (Gain) to set the value for MX+B equation.
gain M value



F4 (B Value) key Press the key to enter the menu to configure a B (Offset) to set the value for MX+B equation.
offset B value



F5 (B (Offset)) Press the key to instantly perform an offset current key to get value measurement for the B (Offset) value.
at once

F2 (MathDisp) Press the key to show the MathDisp menu for 4 different key to select display modes. See the following descriptions for details.



Note

Only when Alarm configuration is enabled can the “Alarm” and “ALR+STAT” of Math Display are available to activate.

Show STAT
Result

Description The STAT page in MathDisp allows user to make statistical calculations for measurements including Minimum, Maximum, Average Peak-Peak, Standard Deviation and Count.

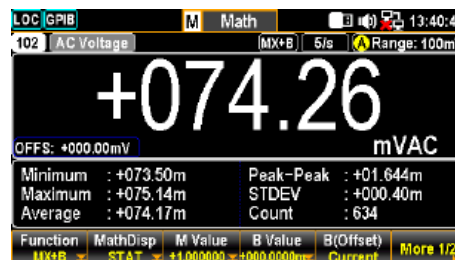

Values +074.26 mVAC Indicates the latest MX+B value

Minimum Indicates the minimum value

Maximum	Indicates the maximum value
Average	Indicates the average value
Peak-Peak	Indicates the peak to peak value
STDEV	Indicates the standard deviation value
Count	Indicates the latest counts of MX+B

Show Math Result

Description The Math page in MathDisp allows user to view mathematical calculations for several parameters.

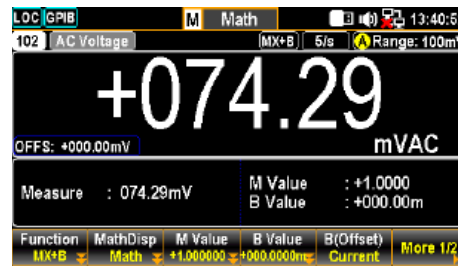

Values	+074.29 mVAC	Indicates the latest MX+B value
	Measure	Indicates the originally measured Voltage value
	M Value	Indicates the defined M value
	B Value	Indicates the defined B value

Show Alarm Result

Description The Alarm page in MathDisp allows user to track if measured data exceeds the set High and Low limits, individually.

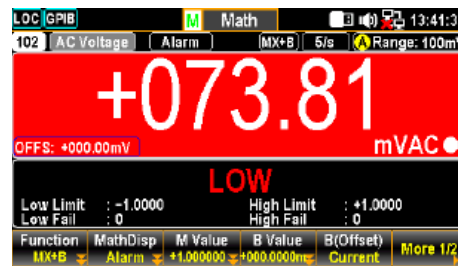

Values	Low Limit	Indicates the set low limit of channel
	High Limit	Indicates the set high limit of channel
	Low Fail	Indicates the numbers of low limit exceeding
	High Fail	Indicates the numbers of high limit exceeding

Show
ALR+STAT
Result

Description The ALR+STAT page in MathDisp allows user to view information from both STAT and Alarm pages simultaneously.

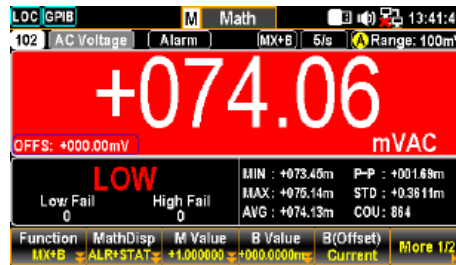

Values	Left Sec.	The numbers of High and Low limits exceeding are shown individually.
	Right Sec.	The values, which based on MX+B calculation, identical to STAT page are well displayed.



Note

Only when Alarm configuration is enabled can the “Alarm” and “ALR+STAT” of Math Display are available to activate. Refer to page 102 for details of Alarm.

F6 (More 1/2) key Press the key to enter the next page (More 2/2) of more to enter next functions configurations for MX+B.
function keys page

Function Keys in
More 2/2 page



F1 (B (Offset)) key Press the key to clear the B value to zero.
to clear B value

F2 (User Units) key Press the key to enable or disable user-defined units.
to turn On or Off Choosing On will display user-defined units on
user-defined units measurement; selecting Off will display default units (VDC).

F3 (Units) key to Press the key to specify a user-defined string, which consists of
edit User Units up to 3 characters and is shown in the Monitor mode display.

F5 (Decimal PT) Press the key to show the Decimal Point menu to configure key to configure either Auto or Range mode for Monitor display. Auto means that the unit of measured reading fluctuates with the actual measured condition, whilst Range indicates that the unit of measured reading is fixed in accord with the set range setting.

Auto

The measured reading display fluctuates with actual condition.

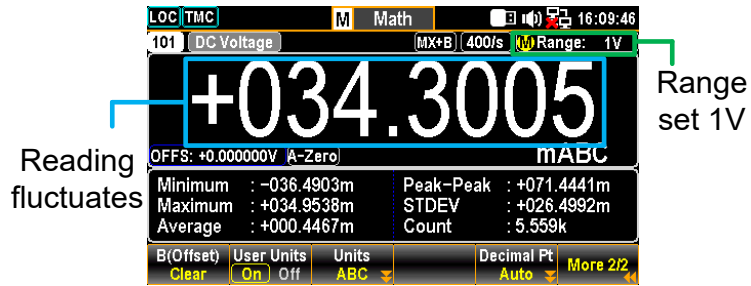

Range

The measured reading display is consist with the set range.

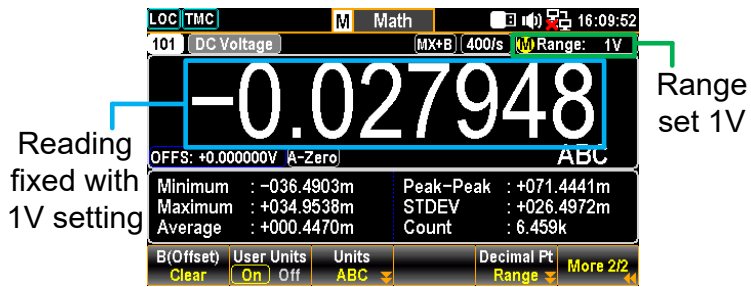

1/X Measurement

Math Equation Divides 1 by the reading (X).

F1 (Function) key to select 1/X equation

1/X



F2 (MathDisp) key to select display modes

Press the key to show the MathDisp menu for 4 different displays. See the following descriptions for details.



Only when Alarm configuration is enabled can the “Alarm” and “ALR+STAT” of Math Display are available to activate.

Show STAT Result

Description The STAT page in MathDisp allows user to make statistical calculations for measurements including Minimum, Maximum, Average Peak-Peak, Standard Deviation and Count.



Values	+0.141745 k	Indicates the 1/X calculation
	Minimum	Indicates the minimum value
	Maximum	Indicates the maximum value
	Average	Indicates the average value
	Peak-Peak	Indicates the peak to peak value
	STDEV	Indicates the standard deviation value
	Count	Indicates the latest counts of 1/X

Show Math Result

Description The Math page in MathDisp allows user to view mathematical calculations for several parameters.

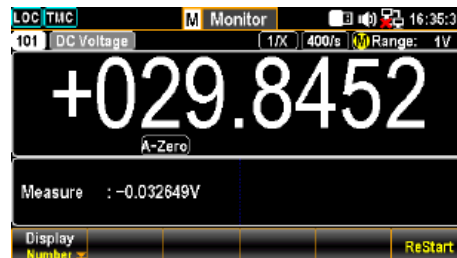

Values	+029.8452	Indicates the 1/X calculation
	Measure	Indicates the originally measured Voltage value

Show Alarm Result **Description** The Alarm page in MathDisp allows user to track if measured data exceeds the set High and Low limits, individually.



Values	Low Limit	Indicates the set low limit of channel
	High Limit	Indicates the set high limit of channel
	Low Fail	Indicates the numbers of low limit exceeding
	High Fail	Indicates the numbers of high limit exceeding

Show ALR+STAT Result **Description** The ALR+STAT page in MathDisp allows user to view information from both STAT and Alarm pages simultaneously.

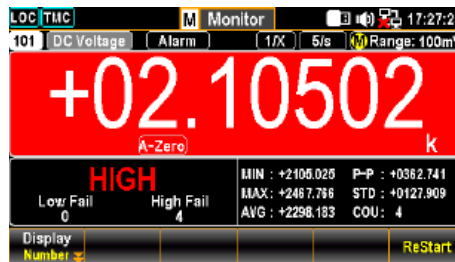

Values	Left Sec.	The numbers of High and Low limits exceeding are shown individually.
	Right Sec.	The values, which based on 1/X calculation, identical to STAT page are well displayed.



Note

Only when Alarm configuration is enabled can the “Alarm” and “ALR+STAT” of Math Display are available to activate. Refer to page 102 for details of Alarm.

Percent Measurement

Math Equation
$$\frac{(\text{ReadingX} - \text{Reference})}{\text{Reference}} \times 100\%$$

F1 (Function) key to select Percent equation



F3 (REF %) key to set the Reference value

Press the key to enter the menu to configure a Reference value for Percent equation.



F4 (REF %) key to get value at once

Press the key to instantly perform an reference measurement for the REF % value.

F2 (MathDisp) key to select display modes

Press the key to show the MathDisp menu for 4 different displays. See the following descriptions for details.





 Note Only when Alarm configuration is enabled can the “Alarm” and “ALR+STAT” of Math Display are available to activate.

Show STAT Result Description The STAT page in MathDisp allows user to make statistical calculations for measurements including Minimum, Maximum, Average Peak-Peak, Standard Deviation and Count.

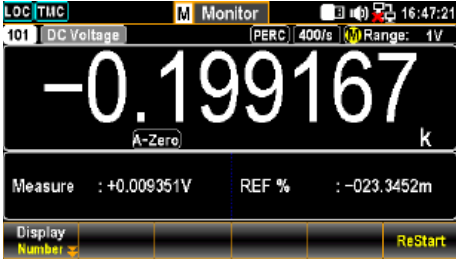

Values	-30.2959	Indicates the Percent calculation
	Minimum	Indicates the minimum value
	Maximum	Indicates the maximum value
	Average	Indicates the average value
	Peak-Peak	Indicates the peak to peak value
	STDEV	Indicates the standard deviation value

	Count	Indicates the latest counts of Percent
Show Math Result	Description	The Math page in MathDisp allows user to view mathematical calculations for several parameters.
		
	Values	-0.199167 k Indicates the Percent calculation
		Measure Indicates the originally measured Voltage value REF % Indicates the defined reference % value
Show Alarm Result	Description	The Alarm page in MathDisp allows user to track if measured data exceeds the set High and Low limits, individually.
		
	Values	Low Limit Indicates the set low limit of channel
		High Limit Indicates the set high limit of channel
	Low Fail	Indicates the numbers of low limit exceeding
	High Fail	Indicates the numbers of high limit exceeding

Show
ALR+STAT
Result

Description The ALR+STAT page in MathDisp allows user to view information from both STAT and Alarm pages simultaneously.

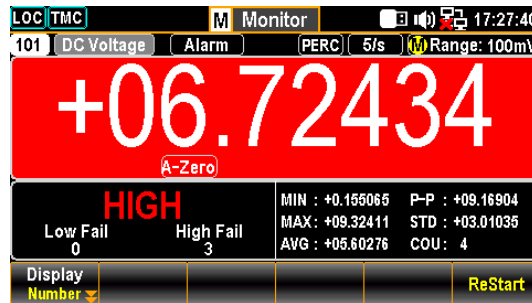

Values Left Sec. The numbers of High and Low limits exceeding are shown individually.

Right Sec. The values, which based on Percent measurement, identical to STAT page are well displayed.



Note

Only when Alarm configuration is enabled can the “Alarm” and “ALR+STAT” of Math Display are available to activate. Refer to page 102 for details of Alarm.

Average Menu

Background

Press the *Average* key on the front panel to enter the Average menu. The digital average function averages a specified number of input signal samples to generate one reading. The following diagram demonstrates the method of Average using 4 samples per reading.

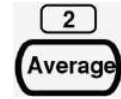

Average

The digital average renews a whole group of samples per reading. This method is recommended when using the optional scanner.

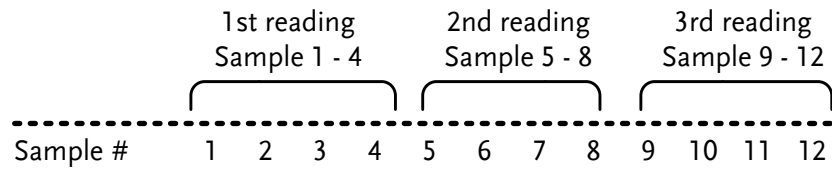

F1 (Average) key to turn On/Off Average function

Press the key to enable or disable the Average function.



F2 (Count) key to specify sample counts per reading

Press the key to enter the menu to specify count of average, which defines the number of samples to be averaged per reading. More samples offer low noise but a long delay. Less samples offer high noise but a short delay.



F3 (WinMethod) key to select Average Window Method

Press the key to enter the Average Window Method menu. Average window defines the threshold for when the digital average data is updated again. When the data falls in the range between TH and TL, the Average keeps processing. When the data falls out of the range between TH and TL, the Average will restart. When measuring unstable signals, appropriately setting the average window can improve the measurement speed.

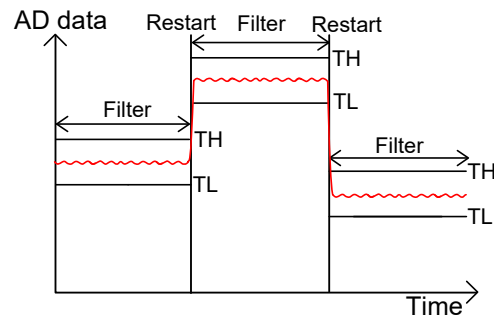

TH: Threshold High, TL: Threshold Low

F4 (Window) key to specify Average Window range

Measure:
 $\text{Previous Meas} * (1 - \text{window}) < \text{threshold} < \text{Previous Meas} * (1 + \text{window})$

Range:
 $\text{Previous Measure} + (\text{Range} * \text{window}) < \text{threshold} < \text{Previous Measure} + (\text{Range} * \text{window})$



Log Menu

Background Press the *Log* key on the front panel to enter the Log menu, which allows user to perform Capture function, which captures screenshot of hardcopy, or to operate ScanData, which saves data log of scanned readings into installed USB disk.

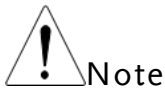

Note

Before performing Log functions, be aware of the supported USB disk as following:

- USB Disk Type: Flash Disk Only
- FAT Format: Fat16 or Fat32 (Recommended)
- Max memory size: 128GB
- USB disk which requires card adaptor is Not recommended to be used in this application.

Capture

Steps

1. Press the *Log PARA* (F1) key to select Capture.



2. Press the *FileName* (F2) key to determine filename of captured screenshots. The “Default” option remains filename in date & time format (e.g., SCREEN_20220909 13-20-25).

3. If selecting “Manual” option, press the *EditName* (F3) key to enter the keyboard page to edit a user-defined filename.



4. Press the *Capture* (F4) key to perform screenshot capturing. The prompt message pops up after completing capturing.

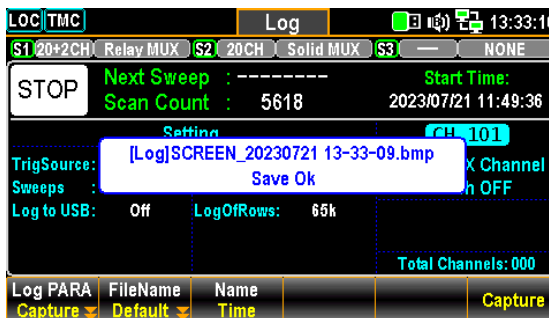

Scan Data

Steps

1. Press the *Log PARA* (F1) key to select ScanData.



2. Press the *Logging* (F2) key to activate if scanned readings data will be saved into the inserted USB disk automatically. Selecting “Off” will not automatically save data into the USB disk and instead require manual operation for saving data.

From the Home screen, if auto-Logging function is enabled, the Log to USB will be shown “On”. Refer to page 35 for details of Home screen.

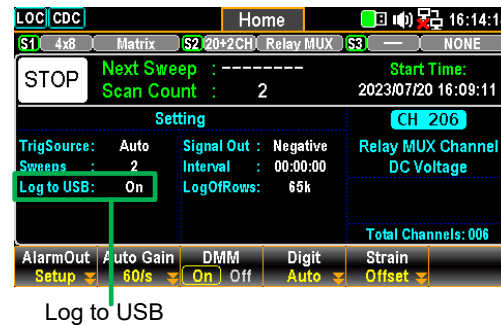

3. Press the *# Rows* (F3) key to specify the row limit, which indicates the max. number of rows for sweep data, of each data logging file. The “65k” means the limit is 65,536 rows per file. The “1M” indicates the limit is 1,048,576 rows per file and the “Infinite” stands for the limit varies based on the number of bytes permitted by file system itself.



4. Press the *Separation* (F4) key to designate a symbol of separation (Comma, Semicolon or TAB), which is placed between intervals of each count of readings within the export scanned data.



5. Press the *SaveRead* (F6) key to perform data log of scanned readings saving into installed USB disk manually.

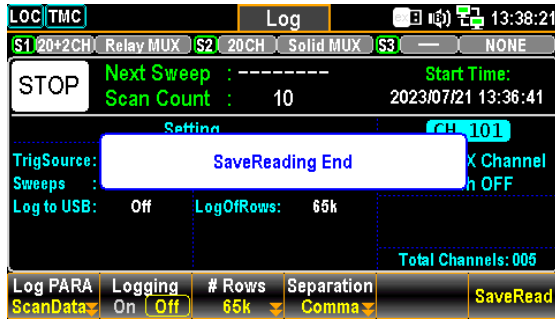

DIGITAL I/O

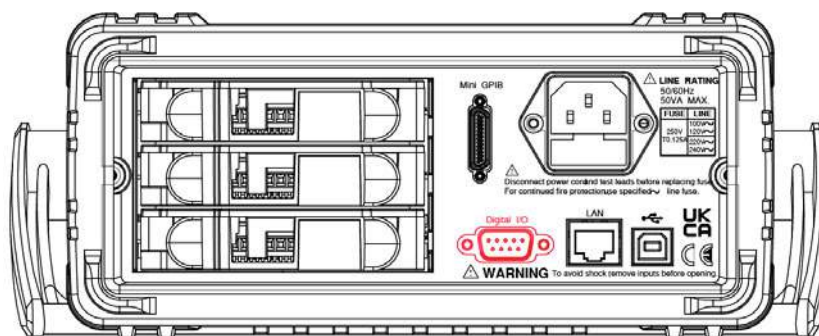

Digital I/O Overview	139
Application: Alarm Output	141
Application: External Trigger.....	143

Digital I/O Overview

Background The Digital I/O port contains 1 pin for External Trigger Input and 4 pins for Alarm Output.

When external trigger pulse is received by the external trigger input pin, the designated channel will be triggered accordingly.

In terms of the 4 alarm output pins, anyone of the 4 pins can be assigned to anyone of the input channels to trigger external LED light, Relay control or send a TTL-compatible pulse to control system.

Pin Assignment

Connector type: DB-9 female

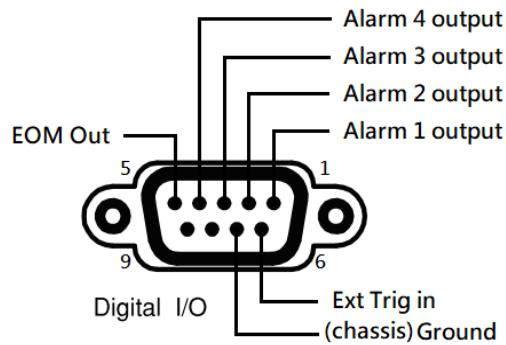

Pin No	Pin Definition
1	Alarm_OUT1
2	Alarm_OUT2
3	Alarm_OUT3
4	Alarm_OUT4
5	EOM Out
6	External Trigger In
7	Digital Ground
8	NC
9	NC

Pin1-4 Pin 1-4 are Output TTL-compatible pins, which are selectable for TTL logic Hi or Lo alarm outputs.

Pins 1-4 output wiring diagram

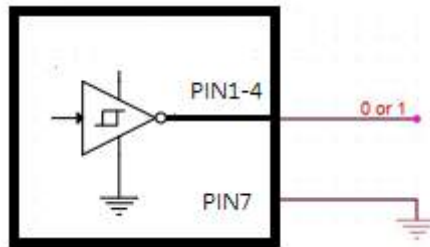

Pin5 EOM (End Of Measurement) signal Output. Activates when compare measurement is over. It is also available in other measurements.

EOM pulse width timing

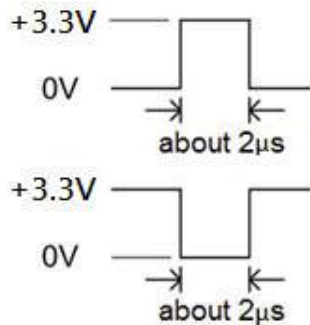

Pin6 External Trigger Input. Accepts external trigger signals. For using external signals.

Pins 6-7 output wiring diagram

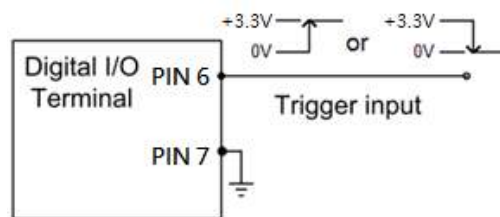

Pin7 Digital (chassis) Ground.

Application: Alarm Output

Background The alarm output pins of Digital I/O port located on the rear panel, which send a TTL-compatible alarm output, can trigger the connected external alarm devices like sirens and LED lights.

Anyone of the 4 alarm output pins can be assigned to anyone of the input channels to trigger external devices or send a TTL-compatible pulse to control system.

Alarm output connection Connect the external alarm output devices to the specific pins of Digital I/O port located on the rear panel.

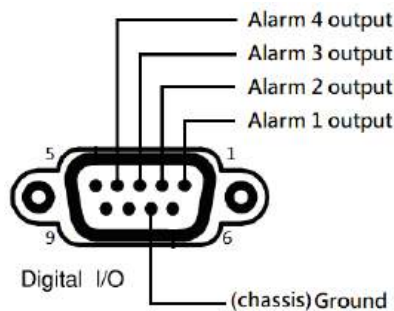

Pin1-4 Alarm output pins

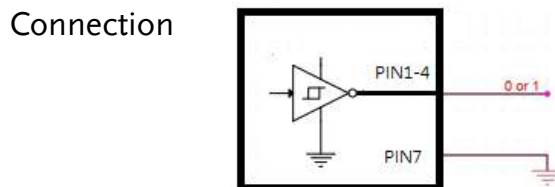

Activate alarm output Press the *Alarm* key on the front panel to enter the Alarm menu.



Alarm	Output	Low Limit	High Limit
High+Low	#2	+1.000000	+033.0000

Use the *knob* key to navigate channels to select a target channel (channel 101 for example below).



The screenshot shows the instrument's interface. At the top, it says 'LOC TMC' and 'Alarm'. Below that, it shows 'S1 20+2CH Relay MUX S2 NONE S3 NONE'. The main display shows 'CH 101' and 'Relay MUX Channel'. Under 'Setting', it lists: Function: DC Voltage, Delay: Auto, M Value: +1.000000, Range: Auto, Speed: 60/s, B Value: +000.0000m, Auto Zero: On, Input R: 10M, Hi Limit: +033.0000, Lo Limit: +1.000000. At the bottom, there is a button labeled 'Alarm #2'. Below the settings, there is a table:

Alarm	Output	Low Limit	High Limit
High+Low	#2	+1.000000	+033.0000

Press the *Alarm* (F1) key to select an alarm limit(s) mode for the select channel.



- OFF Alarm condition is disabled for select channel.
- High+Low Both High and Low limits of Alarm condition are activated.
- High High limit of Alarm condition is activated.
- Low Low limit of Alarm condition is activated.

Press the *Output* (F2) key to select which of the 4 alarm output lines will be utilized to send alarm pulse for the selected channel.



Press the *Low Limit* (F5) and the *High Limit* (F6) keys to specify alarm limits individually for the selected channel.

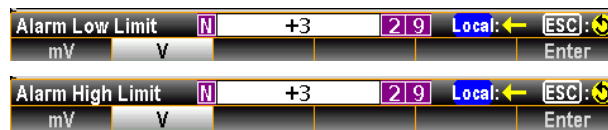

Press the *Scan* key on front panel to initiate a scan course. When the set alarm occurs for select channel during a scan course, the alarm status will be shown clearly as the following example.

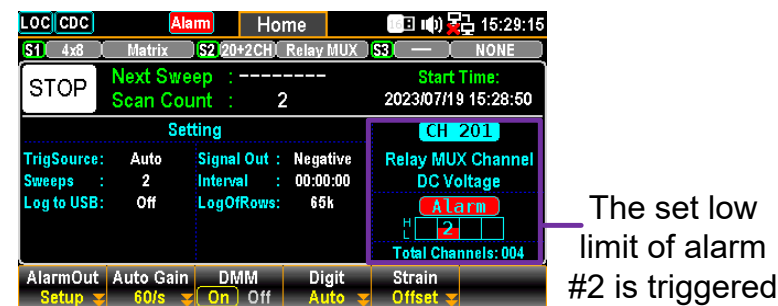

Application: External Trigger

Background The external trigger uses the digital I/O pin for manual triggering of the DAQ-9600. To trigger the DAQ-9600 a pulse of $\geq 10\mu s$ is required.

Signal connection Connect the external trigger signal to the specific pins of Digital I/O port located on the rear panel.

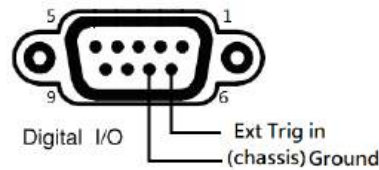

Pin6 External Trigger Input pin

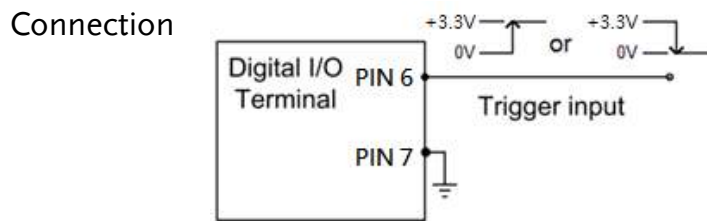

Activate external trigger

Press the *Interval* key on the front panel to enter the Interval menu.



Press the *TrigSource* (F1) key to enter the trigger source menu followed by pressing the *External* (F4) to select External Trigger mode.



During a scan course, each sweep only starts when an external triggered signal is received.

Next sweep waits until External signal

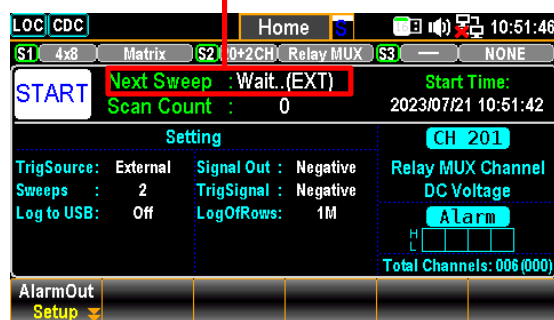

SYSTEM & FIRMWARE

View System Info.....	145
Firmware Update.....	146

View System Info

Background View system information including Vendor, Model Name, Serial Number, Master Firmware and Slave Firmware.

- Step**
1. Press the Menu key, the System configuration menu appears. And press the NEXT key repeatedly or scroll the Knob key to move to the Security&Info – SystemInfo field.

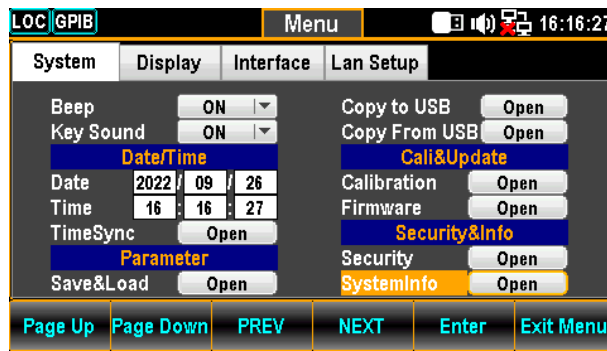
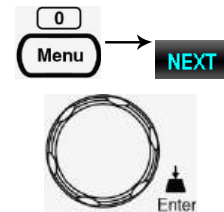

2. Press the F5 (Enter) key or Knob key to enter the System Information where all the critical contents are exposed for check.



Firmware Update

Background This section is for updating the latest firmware.

- Step**
1. Press the Menu key, the System configuration menu appears. And press the NEXT key repeatedly or scroll the Knob key to move to the Cali&Update - Firmware field.

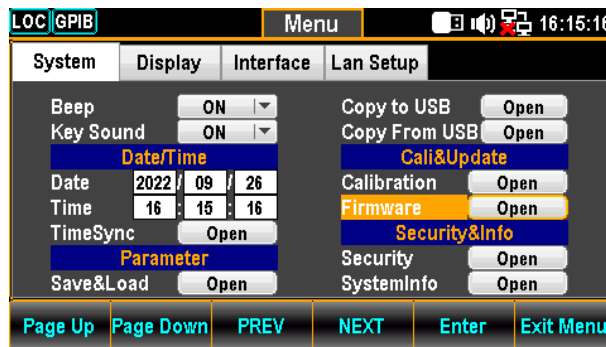
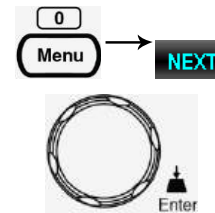

2. Press the F5 (Enter) key or Knob key to enter the Firmware Update menu.

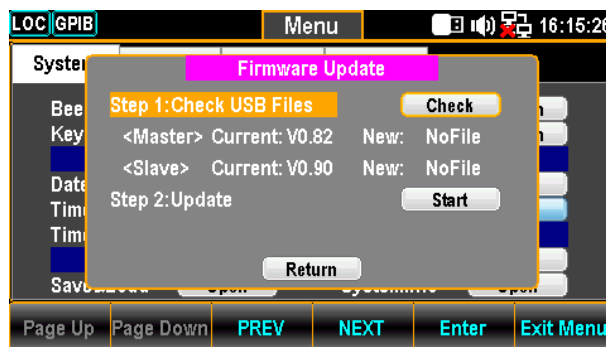

Firmware Update **Update Process** Prior to update, make sure if the required firmware file is stored within the flash drive plugged into the USB port on the front panel. Also, user can check the current Master and Slave firmware version respectively in this menu.

- ⚠ Note Prior to update, please rename the downloaded firmware files as below:
- ✓ Master file: M_IMAGE.bin
 - ✓ Slave file: S_IMAGE.bin

1. Press the F5 (Enter) key or Knob key first, the qualified firmware version will show then.



Note: If flash drive has no update files, it will show as the figure below.



2. Press the NEXT key or scroll Knob key to move to the Update followed by pressing the F5 (Enter) key or Knob key to Start update.



⚠ Note

Refer to page 117 for details of how to update firmware for those installed modules.

MENU SETTING

Configure System	149
Beep Setting	149
Key Sound Setting.....	150
Date Setting.....	151
Time Setting	152
TimeSync Setting	153
Save and Load Parameters.....	154
Copy Parameters To USB	159
Copy Parameters From USB.....	160
Calibration Setting	162
Firmware Update	164
Security Setting.....	166
View System Info	168
Configure Display.....	169
Brightness Setting	169
Auto Off Setting.....	170
Auto Off Time Setting.....	171
1ST Color Setting.....	173
Math Color Setting	174
Display Mode Setting	176
Additional Info Setting.....	178
Language Setting.....	180

Configure System

Beep Setting

Background Enable or Disable Beep Sound.

- Step 1. Press the Menu key, the System configuration menu appears.

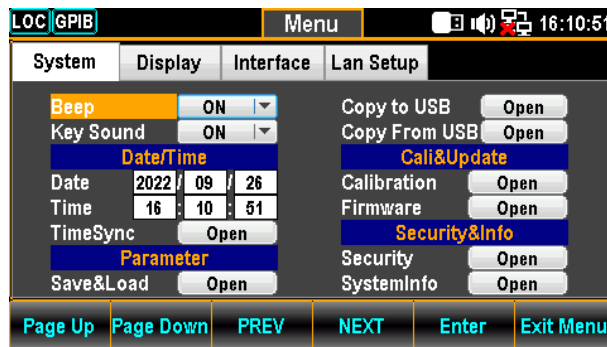
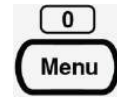

2. Press the F5 (Enter) key or Knob key followed by scrolling Knob key or pressing +/- keys to land on the ON option.

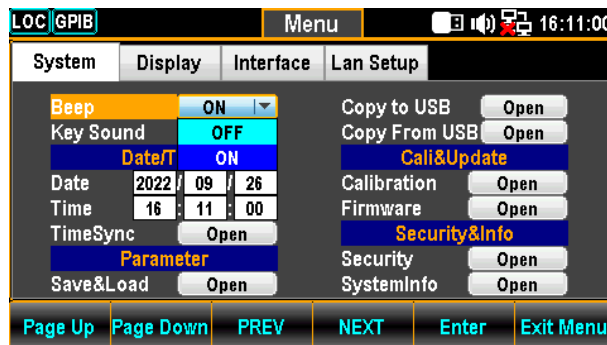
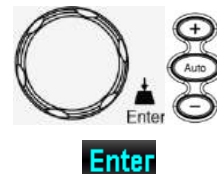

3. Press the F5 (Enter) key or Knob key to select the ON option.



Key Sound Setting

Background Enable or Disable Key Sound.

- Step 1. Press the Menu key, the System configuration menu appears. And then press the NEXT key repeatedly or scroll the Knob key to move to the Key Sound field.

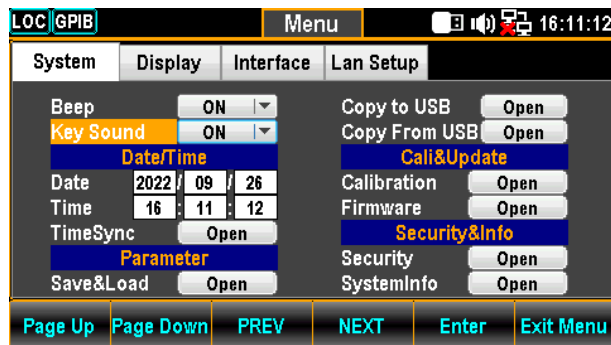
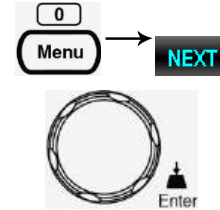

2. Press the F5 (Enter) key or Knob key followed by scrolling Knob key or pressing +/- keys to land on the On option.

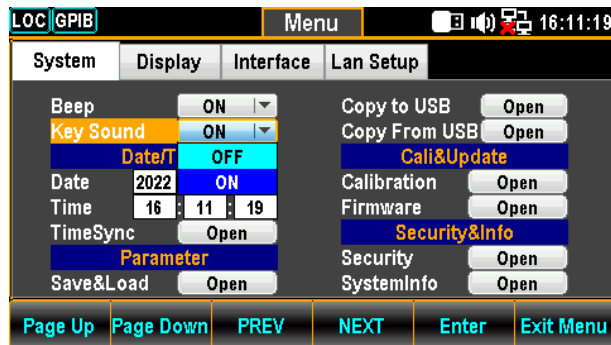
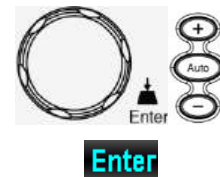

3. Press the F5 (Enter) key or Knob key to select the ON option for Key Sound.



Date Setting

Background Manually adjust date for system or automatically set date via TimeSync setting.

- Step**
1. Press the Menu key, the System configuration menu appears. And press the NEXT key repeatedly or scroll the Knob key to move to the Date/Time - Date field.

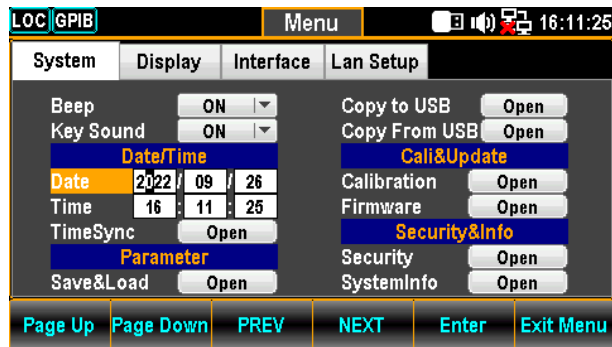
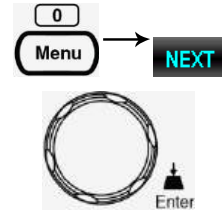

2. Use the Left/Right keys to move the cursor followed by scrolling Knob key or pressing +/- keys to define year of Date. Also, you can press Number keys to directly input a specific digit.

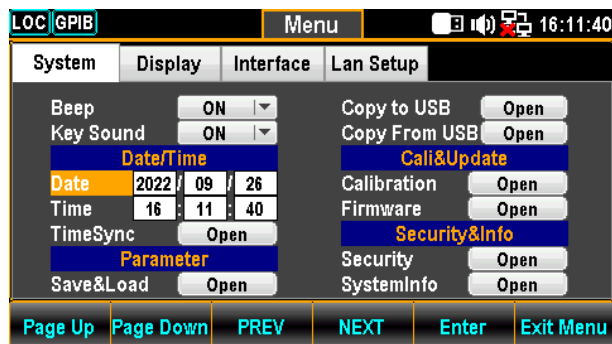
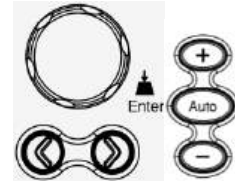

3. Press the F5 (Enter) key or Knob key to confirm the input digit for year of Date.



4. Repeat steps 2 to 3 for month and day.

Time Setting

Background Manually adjust time for system or automatically set time via TimeSync setting.

- Step**
1. Press the Menu key, the System configuration menu appears. And press the NEXT key repeatedly or scroll the Knob key to move to the Date/Time - Time field.

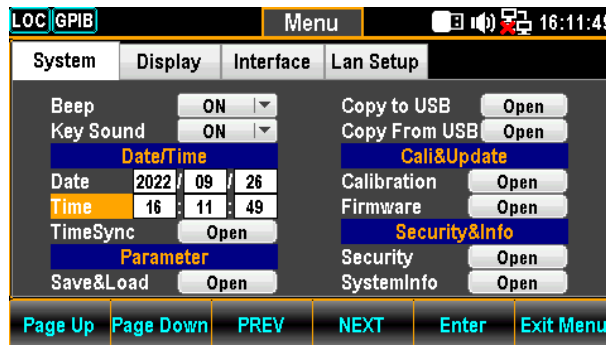
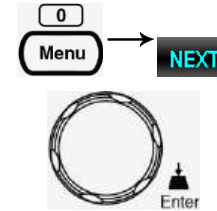

2. Use the Left/Right keys to move the cursor followed by scrolling Knob key or pressing +/- keys to define hour of Time. Also, you can press Number keys to directly input a specific digit.

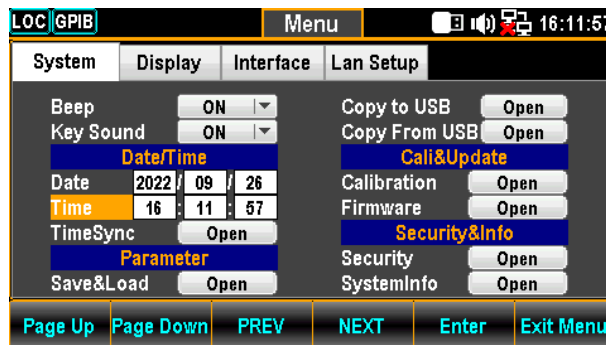
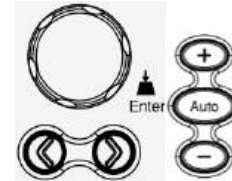

3. Press the F5 (Enter) key or Knob key to confirm the input digit for hour of Time.



4. Repeat steps 2 to 3 for minute and second.

TimeSync Setting

Background TimeSync is only available when connecting to internet with appropriate network setting.

- Step**
1. Press the Menu key, the System configuration menu appears. And press the NEXT key repeatedly or scroll the Knob key to move to the Date/Time - TimeSync field.

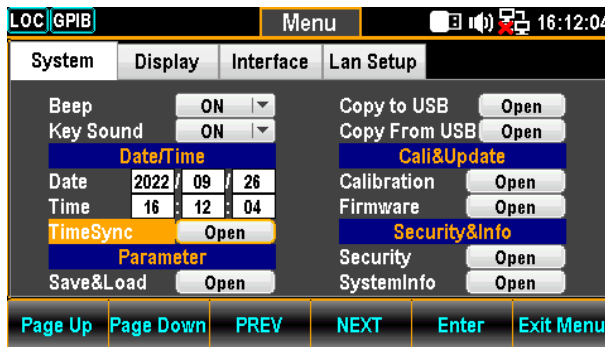
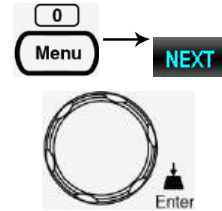

2. Press the F5 (Enter) key or Knob key to enter the Internet Time Sync menu.

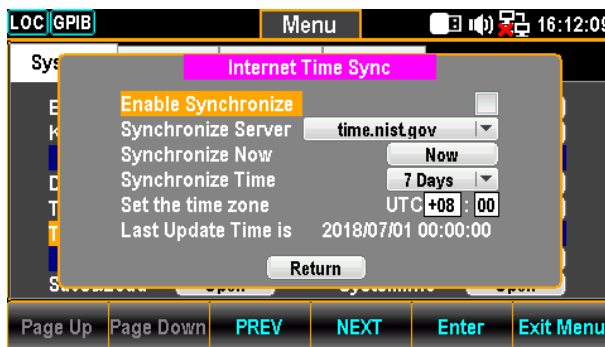
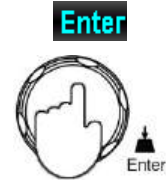

Internet Time Synchronize

Enable Synchronize

Enable or disable time sync

Check / Uncheck

Synchronize Server

Choose remote server for time sync

time.nust.gov / time-nw.nist.gov

The 2nd server is available for user customization. Refer to page 230 for SCPI setting.

Synchronize Now	Retrieve the currently standard time from the remote sever.
Synchronize Time	Define an interval to retrieve the currently standard time from the remote sever.
	7 Days / 14 Days / 30 Days
Set the time zone	Set UTC (Coordinated Universal Time)
	hour / minute
Last Update Time is	Display the currently standard time.

Save and Load Parameters

Background The DAQ-9600 can save several instrument settings, which include the state, function, I/O and range settings. The Load function makes the saved settings or default setting to be recalled at the next power up or immediately.

- Step**
1. Press the Menu key, the System configuration menu appears. And press the NEXT key repeatedly or scroll the Knob key to move to the Parameter – Save&Load field.

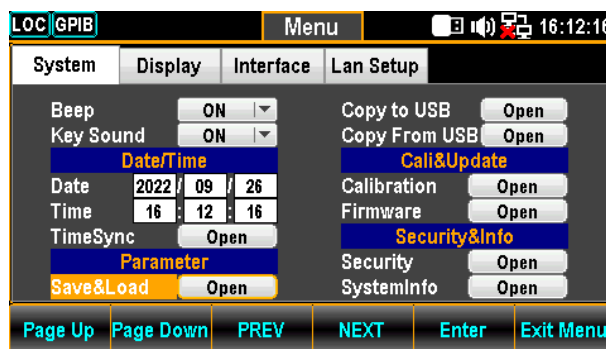
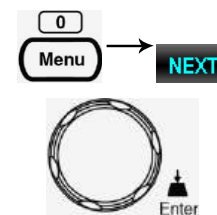

2. Press the F5 (Enter) key or Knob key to enter the Parameter Save&Load menu.



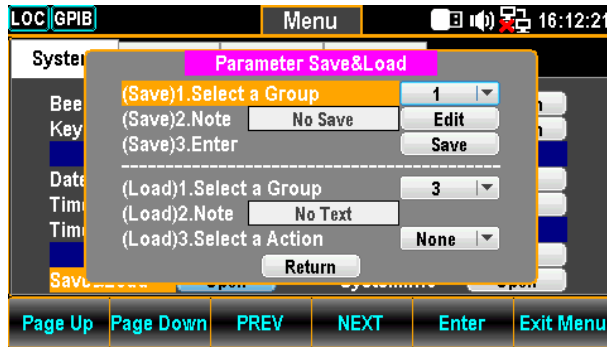

Parameter Save&Load

Save

Select a Group

1. Press the F5 (Enter) key or Knob key to open the dropdown menu.

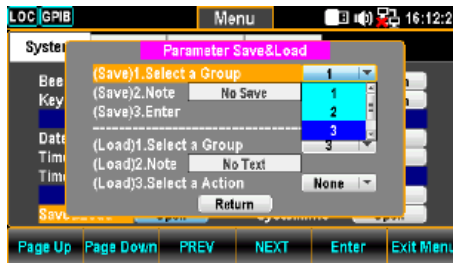

2. Scroll the Knob key or pressing +/- keys followed by pressing the F5 (Enter) key or Knob key to confirm the group selection.

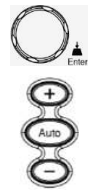

3. Press the F5 (Enter) key or Knob key to open the KeyBoard page.



4. Press the F2 (Backspace) key to clear default words.

Backspace



5. Use the Left/Right and +/- keys or scroll the Knob key to move the cursor to desired word followed by pressing the F5 (Input) key or Knob key to input the word.

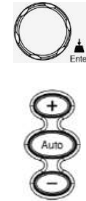

Input



6. Press the F4 (OK) or the Knob key to confirm the input words.

OK

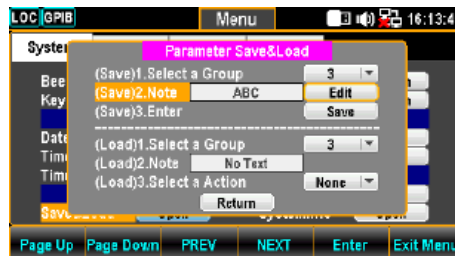

7. Press the F5 (Enter) key or Knob key to saved the input words.

Enter



Load

Select a Group

1. Press the F5 (Enter) key or Knob key to open the dropdown menu.

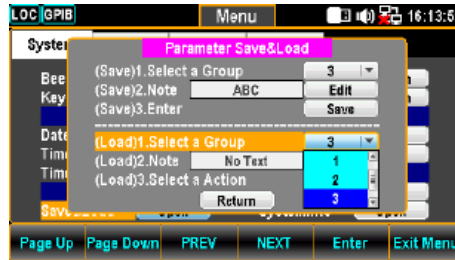

2. Scroll the Knob key or press +/- keys followed by pressing the F5 (Enter) key or Knob key to confirm the group selection.



3. The currently selected group name appears in the Note field.

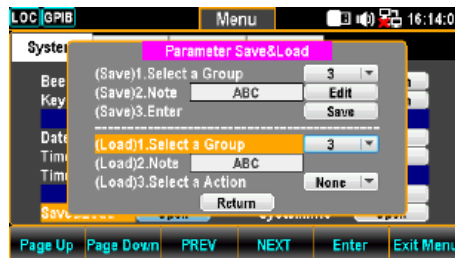

Select a Action

4. Press the F5 (Enter) key or Knob key to open the dropdown menu.

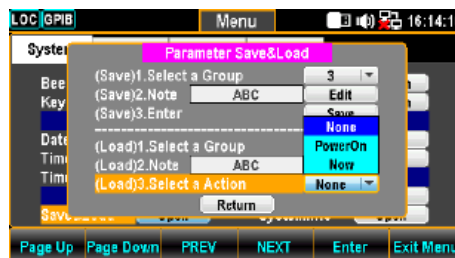

5. Scroll the Knob key or press +/- keys followed by pressing the F5 (Enter) key or Knob key to confirm the action selection.

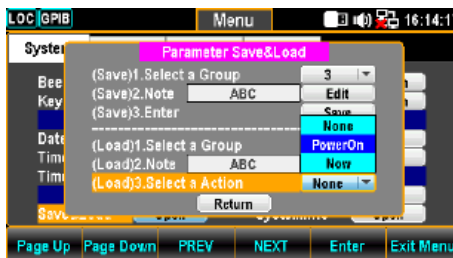

6. Press the F5 (Enter) key or Knob key to confirm the action selection.

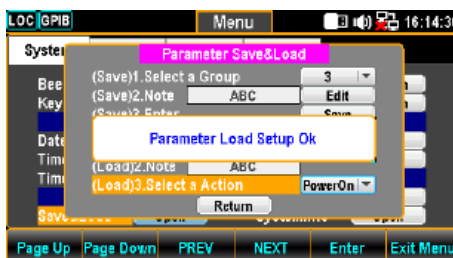

Parameter None: no recall action

Power On: recall at next power up

Now: recall instantly

Copy Parameters To USB

Background This section introduces how to copy the parameters of DAQ-9600 to the connected USB disk.

- Step**
1. Press the Menu key, the System configuration menu appears. And press the NEXT key repeatedly or scroll the Knob key to move to the Copy To USB field.

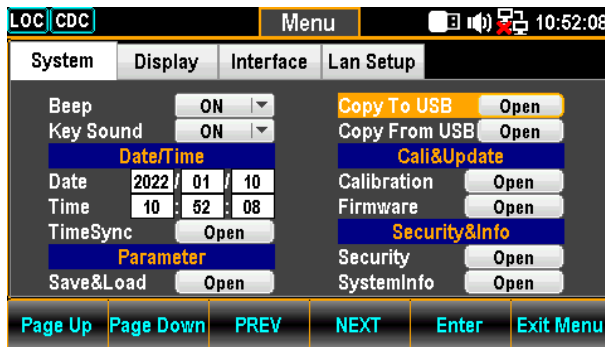
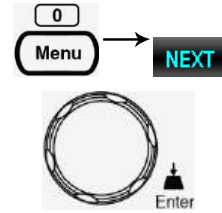

2. Press the F5 (Enter) key or Knob key to bring about the KeyBoard page.

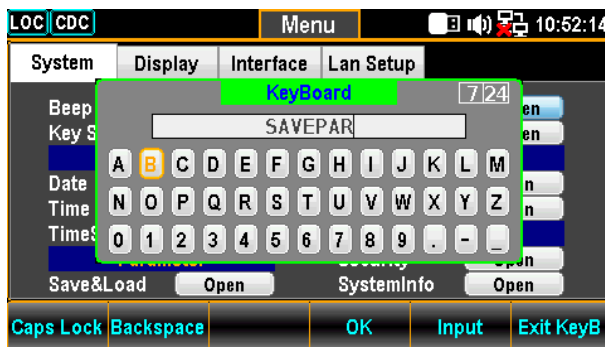
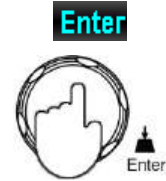

3. Use the Left/Right and +/- keys or scroll the Knob key to move the cursor followed by pressing the F5 (Input) key or the Knob key to specify a name for parameters.

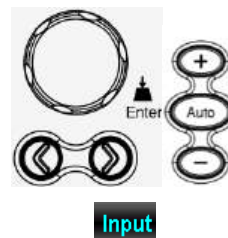

4. Press the F4 (OK) key to confirm the parameters name and copy it to the connected USB disk.

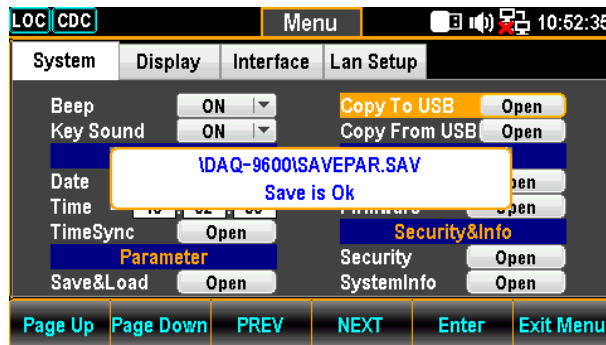

5. The prompt message pops up and indicates the file of parameters is saved to the connected USB completely.

Copy Parameters From USB

Background

This section introduces how to recall the saved parameters from the connected USB disk to DAQ-9600.

Step

1. Press the Menu key, the System configuration menu appears. And press the NEXT key repeatedly or scroll the Knob key to move to the Copy From USB field.

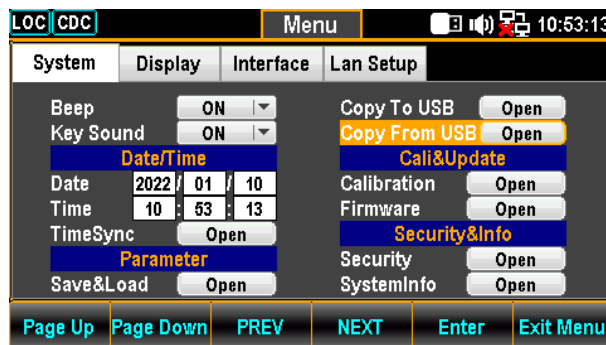
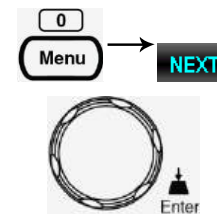

2. Press the F5 (Enter) key or Knob key to bring about the Choose the Load File page.



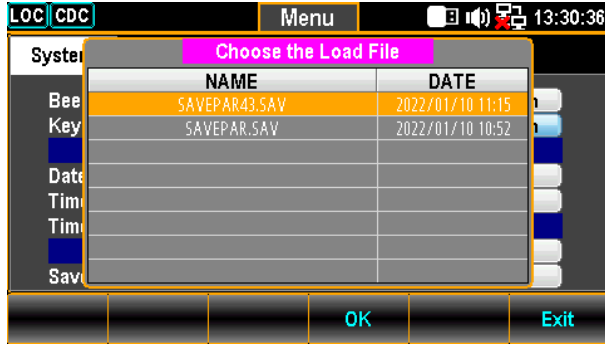

- Use the +/- keys or scroll the Knob key to move among parameters files within the list.

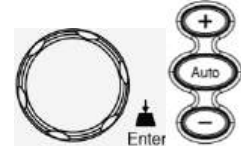

- Press the F4 (OK) key to confirm the selection followed by entering the Parameter Load Option page.

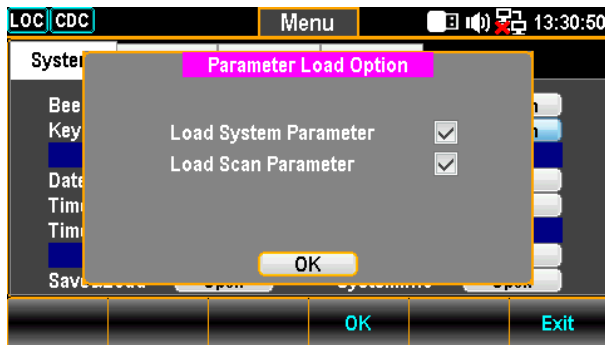

- Scroll the Knob key to move between System and Scan Parameters followed by pressing Knob key to select/unselect parameters. Press F4 (OK) key to load parameters to DAQ-9600.

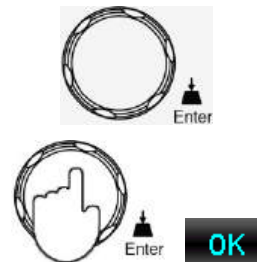

- The prompt message indicates the selected parameters is loaded from the connected USB disk to DAQ-9600.

Calibration Setting

Background This section mainly provides several calibrations for frequency, DC gain and DMM. Note that only the certified technician can operate the calibration procedure. Refer to the qualified personnel for more details when necessary.

- Steps**
1. Press the Menu key, the System configuration menu appears. And press the NEXT key repeatedly or scroll the Knob key to move to the Cali&Update - Calibration field.

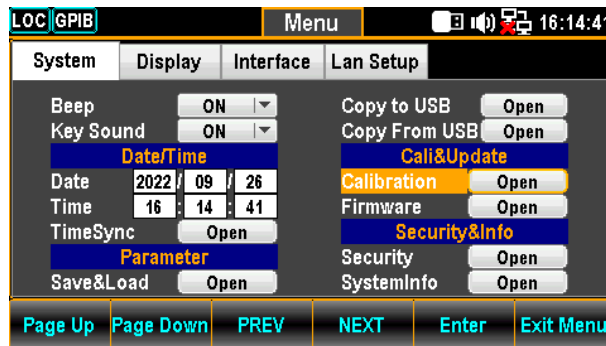
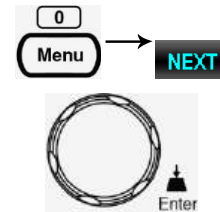

2. Press the F5 (Enter) key or Knob key to enter the Calibration menu.

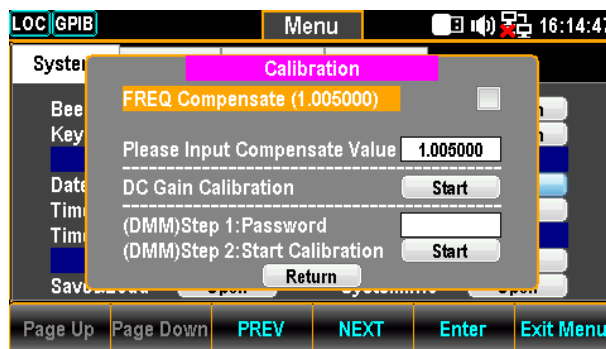

Frequency Calibration	Frequency Compensate (1.005000)	<p>Enable or disable frequency compensation (the value indicates the compensation coefficient; default: Factory calibration value)</p> <p>Check the box to enable: $\text{Frequency} = \text{Original Frequency} \times \text{Compensate Coefficient}$</p> <p>Uncheck the box to disable: $\text{Frequency} = \text{Original Frequency}$</p>
-----------------------	---------------------------------	--

Input Compensate Value

1. Input a compensation coefficient.



2. Use the Left/Right keys to move the cursor followed by pressing the F5 (Enter) key to save the frequency compensation coefficient. The value changes as the figure shown below.

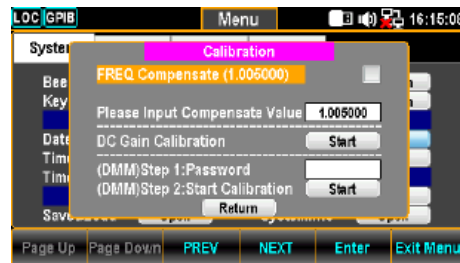

DC Gain Calibration	DC Gain Calibration	<p>Click “Start” to execute DC Gain Calibration, which is an internally self-calibration function that does Not require external signal source. It corrects the gain of internal amplifier, though it is not necessary for general conditions unless the significant change in the gain of internal amplifier. It is suggested performing this calibration one time monthly.</p>
---------------------	---------------------	--

DMM Calibration



The calibration procedure can be only executed by the certified technician in accordance with the standard instruments. Refer to the manufacturer or qualified personnel of authorized dealer for details.

Firmware Update

Background This section is for updating the latest firmware.

- Step**
1. Press the Menu key, the System configuration menu appears. And press the NEXT key repeatedly or scroll the Knob key to move to the Cali&Update - Firmware field.

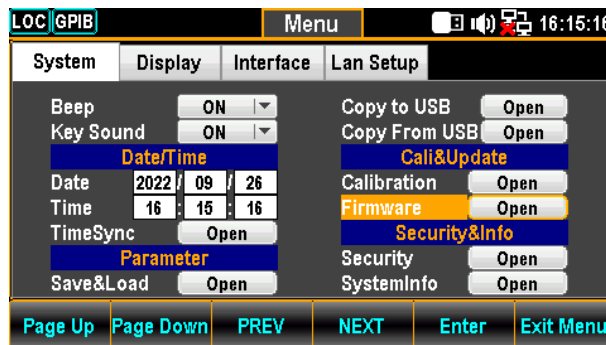
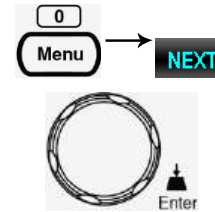

2. Press the F5 (Enter) key or Knob key to enter the Firmware Update menu.



Firmware Update **Update Process** Prior to update, make sure if the required firmware file is stored within the flash drive plugged into the USB port on the front panel. Also, user can check the current Master and Slave firmware version respectively in this menu.

1. Press the F5 (Enter) key or Knob key first, the qualified firmware version will show then.



Note: If flash drive has no update files, it will show as the figure below.



2. Press the NEXT key or scroll Knob key to move to the Update followed by pressing the F5 (Enter) key or Knob key to Start update.



Security Setting

Background This section is to change the password and enable or disable Lan password.

- Step**
1. Press the Menu key, the System configuration menu appears. And press the NEXT key repeatedly or scroll the Knob key to move to the Security&Info – Security field.

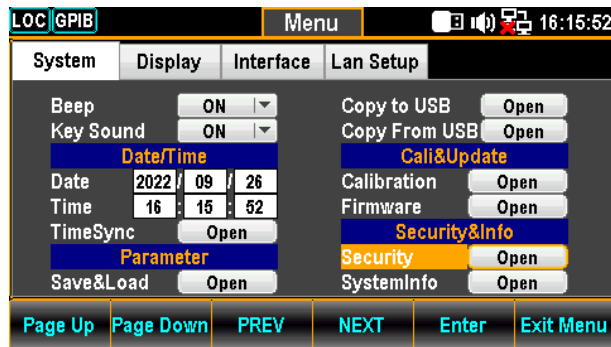
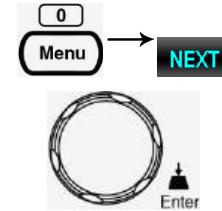

2. Press the F5 (Enter) key or Knob key to enter the Please Input Password page.

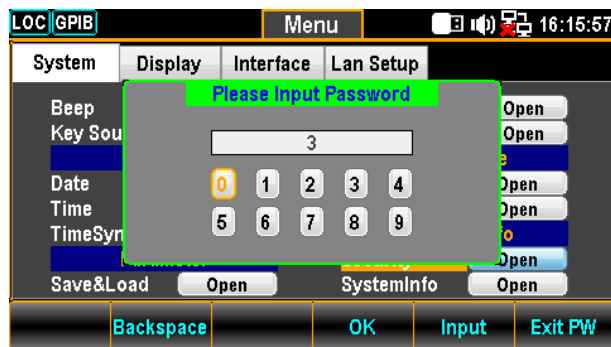
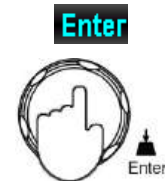

3. Use the Left/Right and +/- keys or scroll the Knob key to move the cursor followed by pressing the F5 (Input) key or the Knob key to input the password.

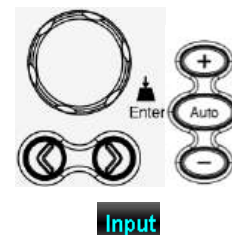

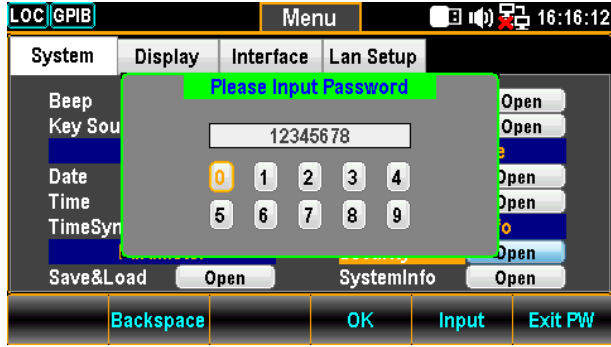

4. Press the F4 (OK) key or Knob key to enter the Security page.

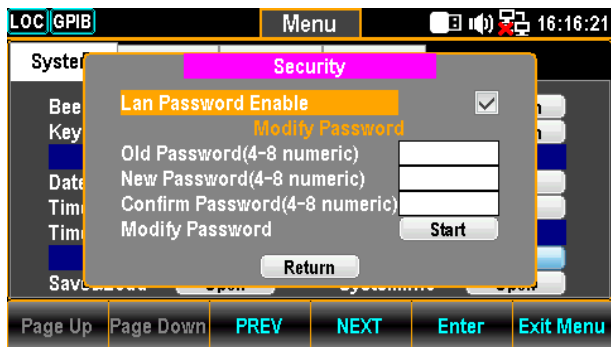

Security	Lan Password Enable	Enable or disable password requirement for Lan web and telnet Control. Check / Uncheck
	Old Password	Enter the old password
	New Password	Enter the new password
	Confirm Password	Enter the new password again
	Modify Password	Change password by clicking Start

View System Info

Background View system information including Vendor, Model Name, Serial Number, Master Firmware and Slave Firmware.

- Step**
1. Press the Menu key, the System configuration menu appears. And press the NEXT key repeatedly or scroll the Knob key to move to the Security&Info – SystemInfo field.

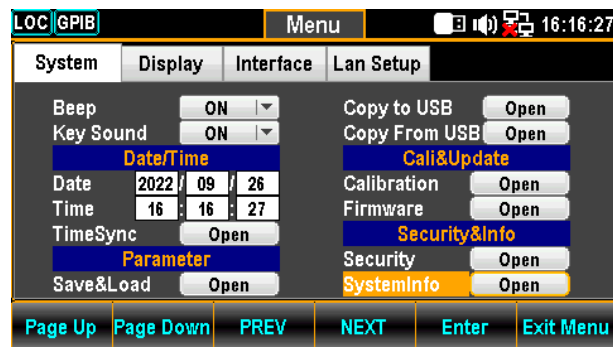
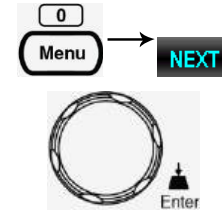

2. Press the F5 (Enter) key or Knob key to enter the System Information where all the critical contents are exposed for check.

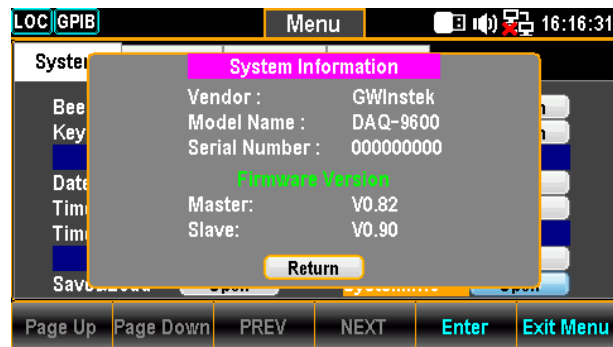

Configure Display

Brightness Setting

Background Backlight brightness adjustment

- Step 1. Press the Menu key followed by pressing the Page Down key repeatedly until the Display configuration menu appears.

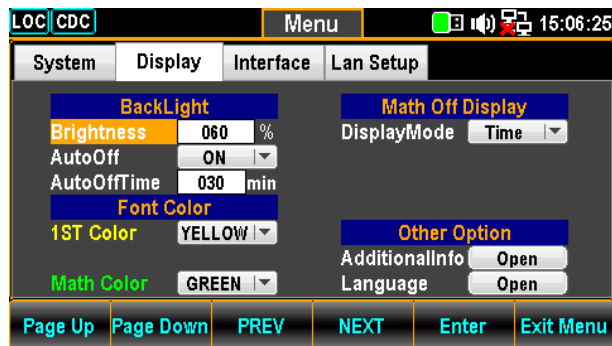
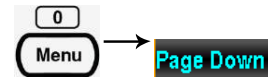

2. Use the Left/Right keys to move the cursor followed by scrolling Knob key or pressing +/- keys to define digit. Also, you can press Number keys to directly input a specific digit.

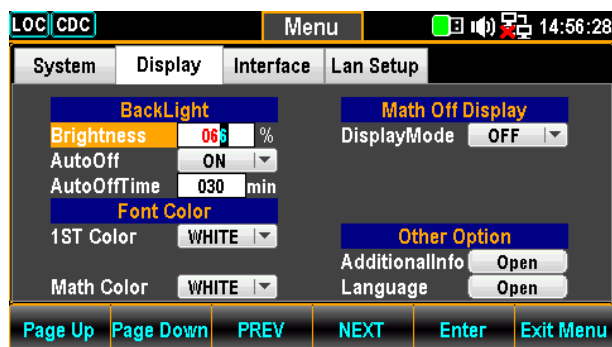
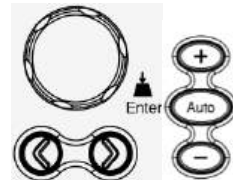

3. Press the F5 (Enter) key or Knob key to confirm the input digit for backlight brightness.



Auto Off Setting

Background Enable or disable automatic brightness adjustment

- Step 1. Press the Menu key followed by pressing the Page Down key repeatedly until the Display configuration menu appears.

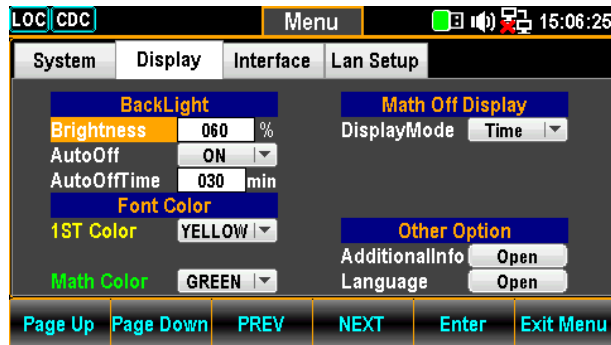

2. Press the NEXT key repeatedly or scroll the Knob key to move to the BackLight - AutoOff field.

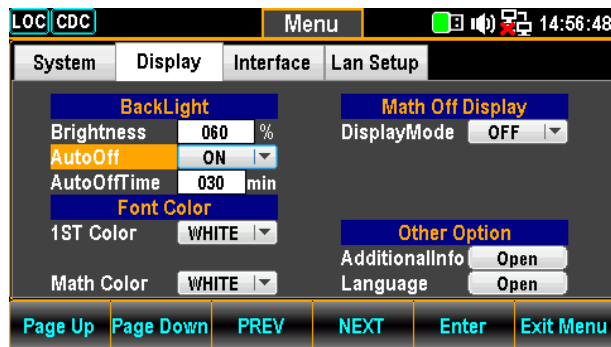
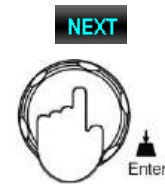

3. Press the F5 (Enter) key or Knob key followed by scrolling Knob key or pressing +/- keys to select the ON option.

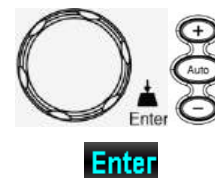

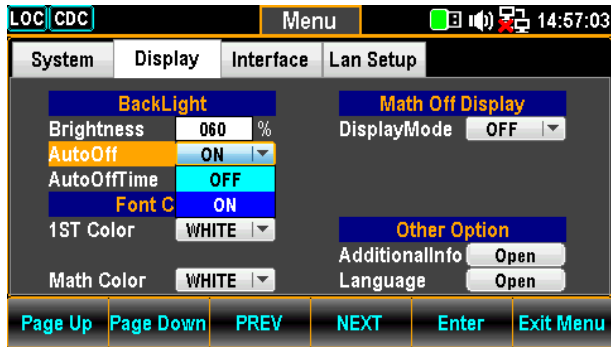

4. Press the F5 (Enter) key or Knob key to confirm the ON option for AutoOff.

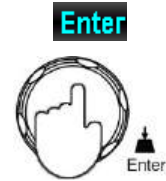

Auto Off Time Setting

Background Set the duration before automatic brightness adjustment. When the machine has been idle for the set duration, the screen will change to automatic brightness adjustment.

NOTE: Auto Off Time will be activated only when Auto Off option is turned ON.

1. Press the Menu key followed by pressing the Page Down key repeatedly until the Display configuration menu appears.

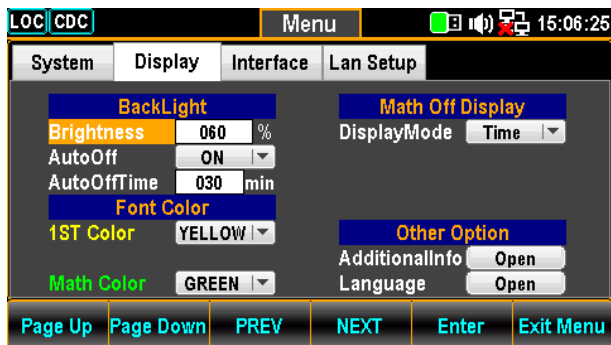

2. Press the NEXT key repeatedly or scroll the Knob key to move to the BackLight – AutoOffTime field.



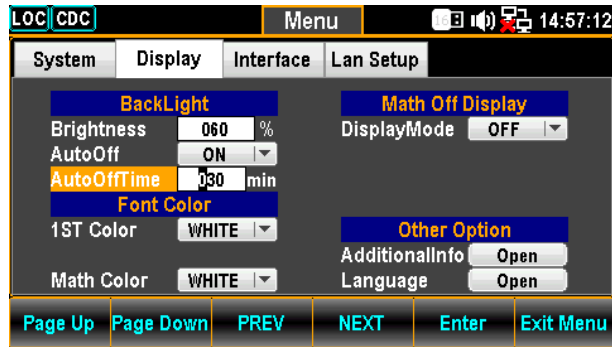

- Use the Left/Right keys to move the cursor followed by scrolling Knob key or pressing +/- keys to define minutes. Also, you can press Number keys to directly input a specific minutes.

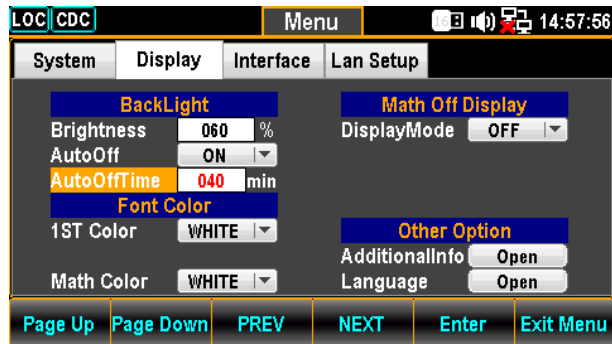
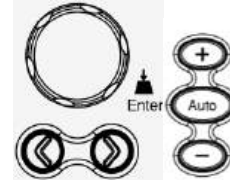

- Press the F5 (Enter) key or Knob key to confirm the input minutes for Auto Off Time.



1ST Color Setting

Background Set the theme color of 1ST display

Step

1. Press the Menu key followed by pressing the Page Down key repeatedly until the Display configuration menu appears.

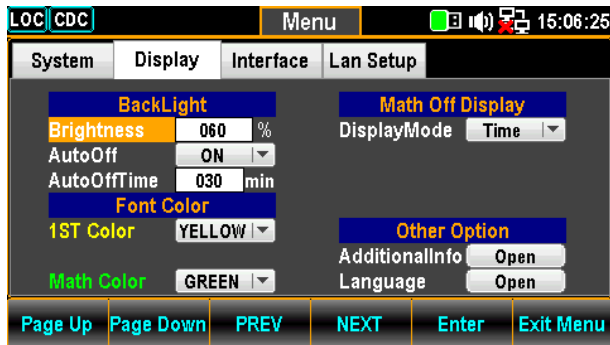

2. Press the NEXT key repeatedly or scroll the Knob key to move to the Font Color – 1ST Color field.

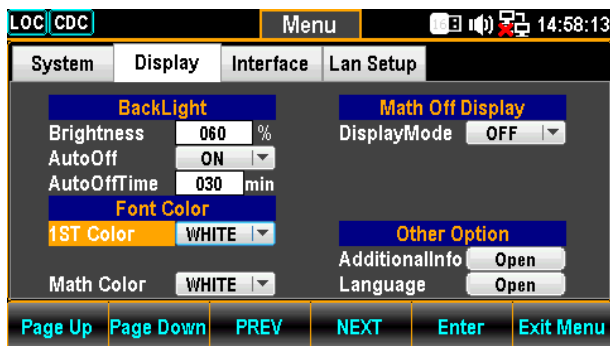

3. Press the F5 (Enter) key or Knob key followed by scrolling Knob key or pressing +/- keys to select desired color for 1ST display.

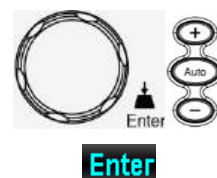

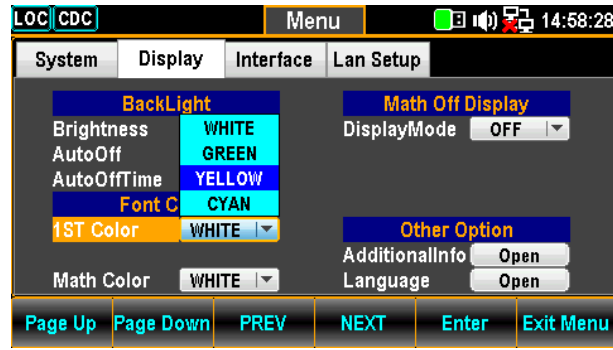

4. Press the F5 (Enter) key or Knob key to confirm the selected color.

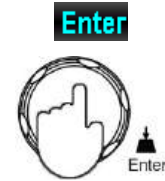

Display result The following figure demonstrates the defined yellow color for 1ST display.

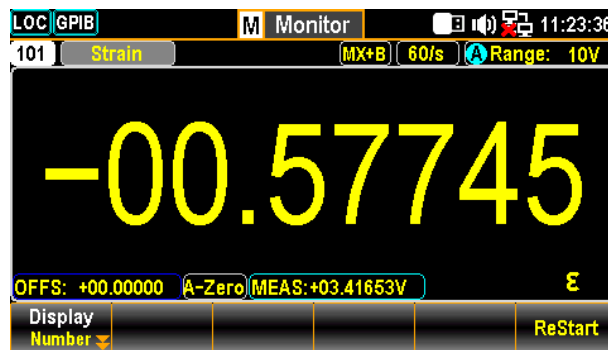

Math Color Setting

Background Set the theme color of Math functions

1. Press the Menu key followed by pressing the Page Down key repeatedly until the Display configuration menu appears.

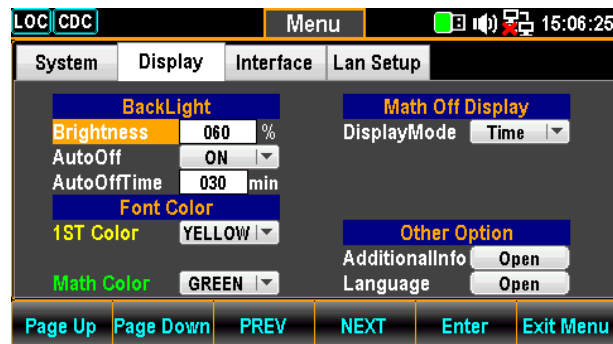
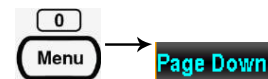

2. Press the NEXT key repeatedly or scroll the Knob key to move to the Font Color – Math Color field.

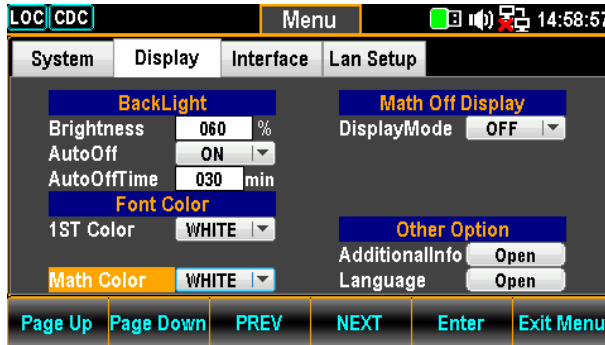

3. Press the F5 (Enter) key or Knob key followed by scrolling Knob key or pressing +/- keys to select desired color for Math display.

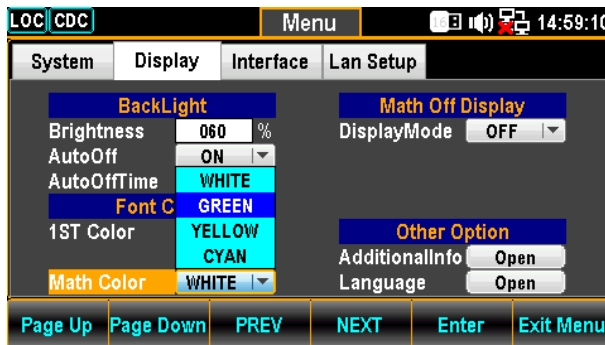
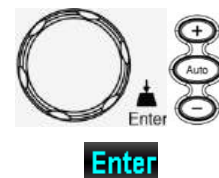

4. Press the F5 (Enter) key or Knob key to confirm the selected color.



Display result

The following figure demonstrates the defined green color for Math display.

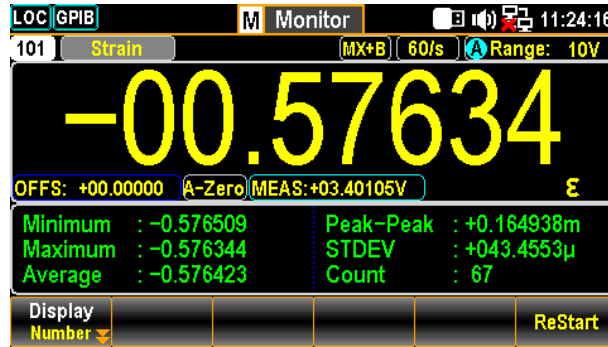

Display Mode Setting

Background Enable or disable if time info or user-defined text is shown in the 1ST display only when MathDisp is off.

- Step**
1. Press the Menu key followed by pressing the Page Down key repeatedly until the Display configuration menu appears.

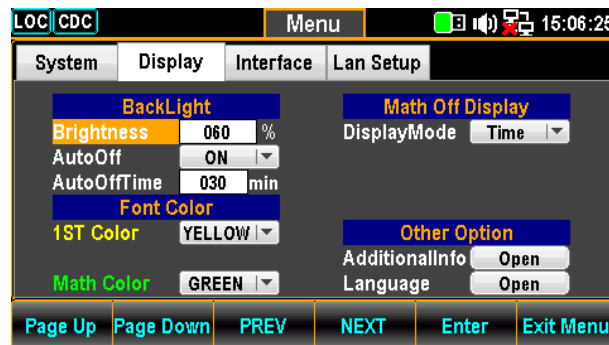
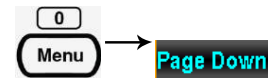

2. Press the NEXT key repeatedly or scroll the Knob key to move to the Math Off Display – DisplayMode field.

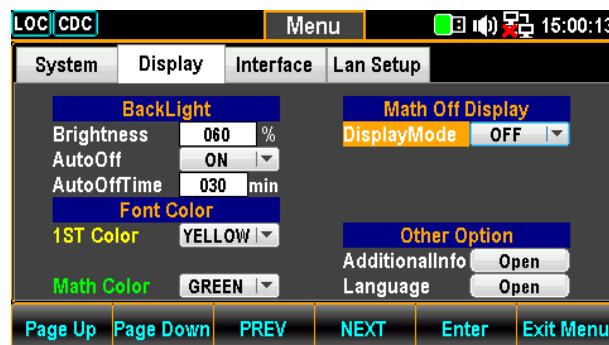

Time display

1. Press the F5 (Enter) key or Knob key followed by scrolling Knob key or pressing +/- keys to select the Time option.

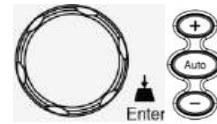

Enter

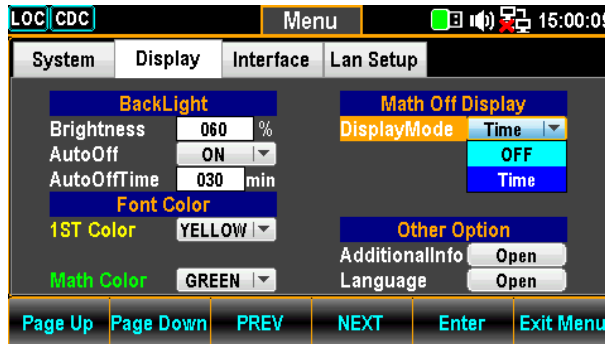

2. Press the F5 (Enter) key or Knob key to confirm the Time option.

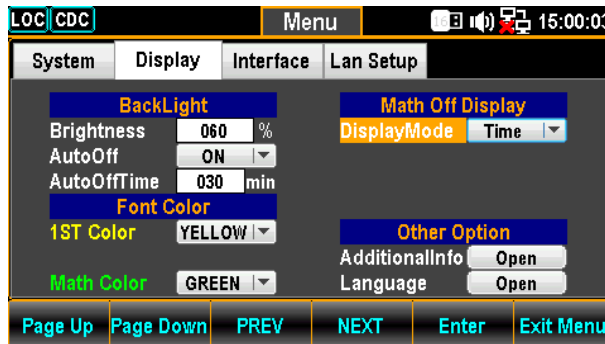

Display result

The following figure demonstrates the time info shown in the 1ST display.

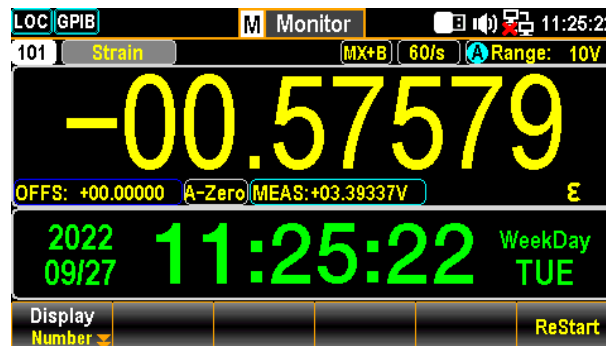

Additional Info Setting

Background Enable or disable the additional information display.

- Step**
1. Press the Menu key followed by pressing the Page Down key repeatedly until the Display configuration menu appears.

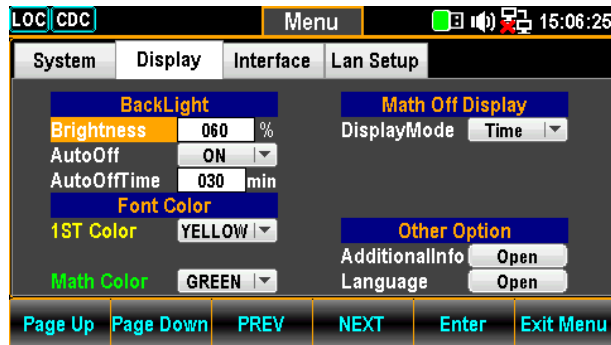
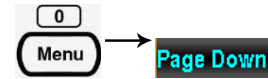

2. Press the NEXT key repeatedly or scroll the Knob key to move to the Other Option – AdditionalInfo field.

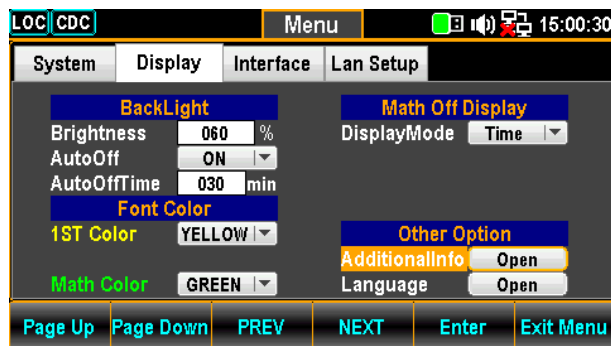
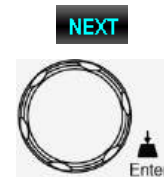

3. Press the F5 (Enter) key or Knob key to enter the Additional menu. Press the Next key or scroll the Knob key followed by pushing the F5 (Enter) key or Knob key to enable/disable each option. Move to the Return option followed by pressing the F5 (Enter) key or Knob key to have the setting take effect.

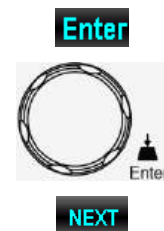

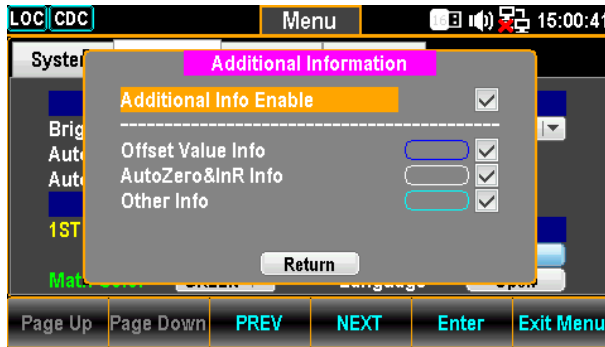

Display result Take the Strain measurement with MX+B calculation for example as the figure below, we can clearly recognize the colors with info as follows.

- Offset Value Info is outlined by blue frame.
- Auto Zero Info is outlined by white frame.
- Other Info is outlined by cyan frame.

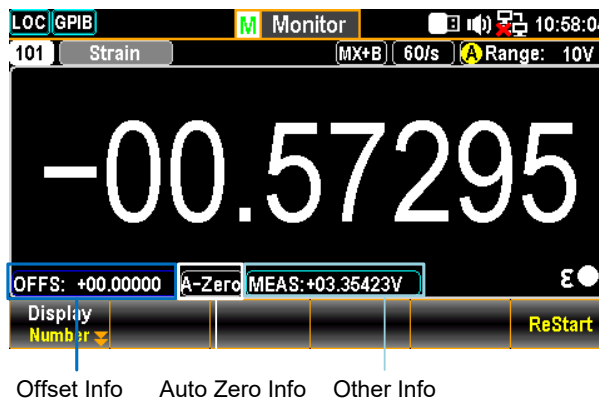

Language Setting

Background Select language for user interface display.

Step

1. Press the Menu key followed by pressing the Page Down key repeatedly until the Display configuration menu appears.

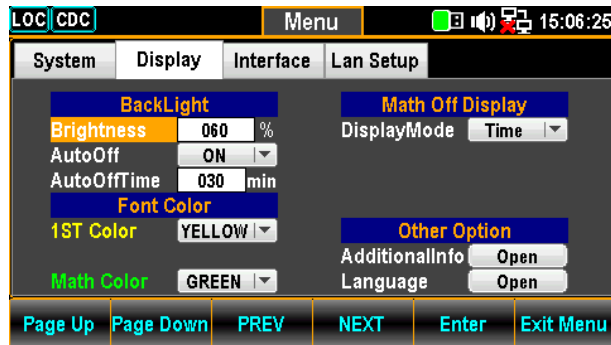

2. Press the NEXT key repeatedly or scroll the Knob key to move to the Other Option – Language field.

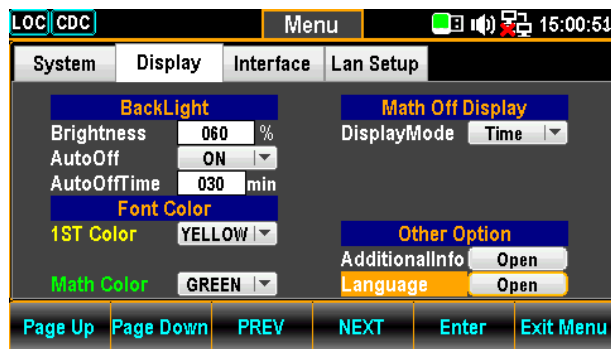
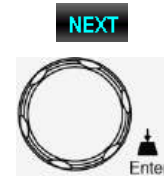

3. Press the F5 (Enter) key or Knob key to enter the Language menu. Press the Next key or scroll the Knob key followed by pushing the F5 (Enter) key or Knob key to select one of the language options. Move to the Return option followed by pressing the F5 (Enter) key or Knob key to have the setting take effect.

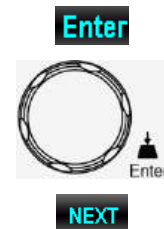

English

Options 繁體中文 (Traditional Chinese)

简体中文 (Simplified Chinese)



REMOTE CONTROL

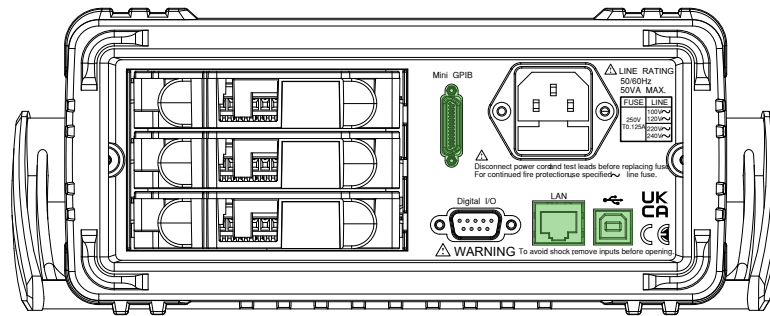

Configure Interface.....	183
Return to Local Control Mode	183
Configure SCPI ID Setting	183
Configure USB Interface	184
Set the USB Protocol	189
Configure GPIB Interface	190
Activate Ethernet Interface	193
LAN Connect Delay Time	194
Reboot LAN Setup	195
Configure Ethernet Interface to DHCP.....	196
Configure Ethernet IP	197
Configure Protocol.....	203
Remote Terminal Session (Telnet / TCP)	209
Web Control Interface.....	210
Command Syntax	214
Command Set	217
Status system.....	337

Configure Interface

Return to Local Control Mode

Background When the unit is in remote control mode, the RMT icon  above the main display can be seen. When this icon is not displayed, it indicates that the unit is in local control mode.

In order to switch back to the Local control mode (front panel operation), press the Shift key.



Configure SCPI ID Setting

Background The *IDN? query returns the manufacturer, model number, serial number and system firmware version number. When SCPI ID is set to User, a user defined manufacturer and model number is returned with the *IDN? query. Please see the SYSTem:IDNStr command on page 333 for details.

Step 1. Press the Menu key, and then the Page Down key repeatedly until the Interface configuration menu appears.

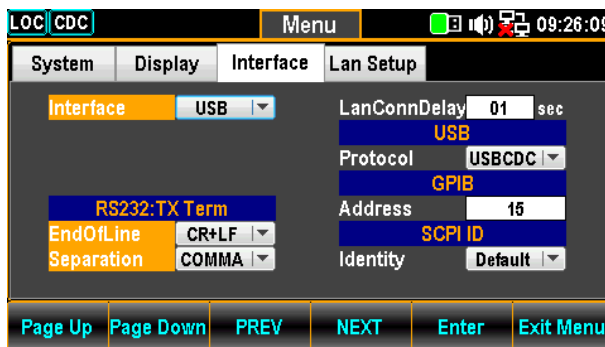
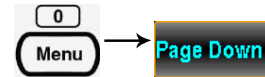

2. Press the F4 (NEXT) key repeatedly or scroll the Knob key to move to the SCPI ID field.

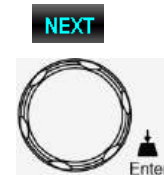

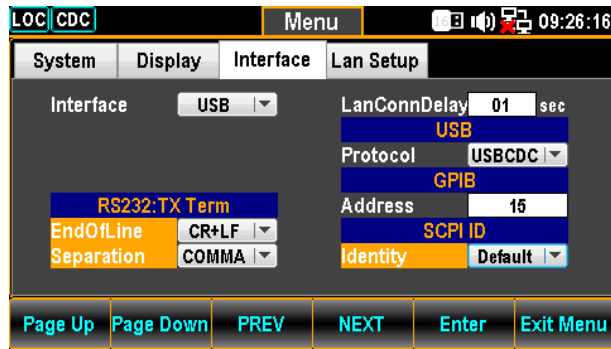

3. Press the F5 (Enter) key or Knob key followed by scrolling Knob key or pressing +/- keys to land on the desired SCPI ID Identity option.

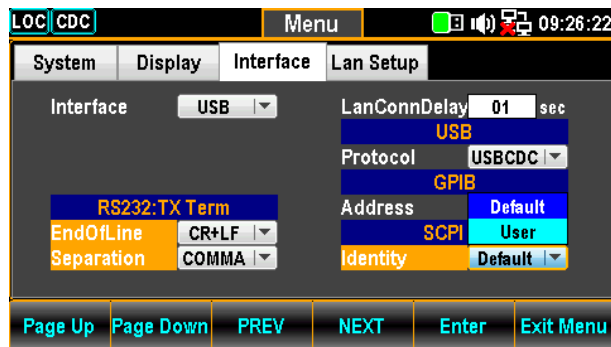
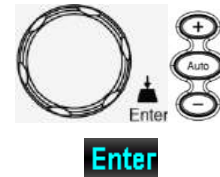

4. Press the F5 (Enter) key or Knob key again to confirm the desired SCPI ID Identity option



Configure USB Interface

USB Configuration	PC side connector	Front panel, Type A, host
	Unit side connector	Real panel, Type B, device
USB Speed	2.0 (Full speed)	

1. Press the Menu key, and then the Page Down key repeatedly until the Interface configuration menu appears.



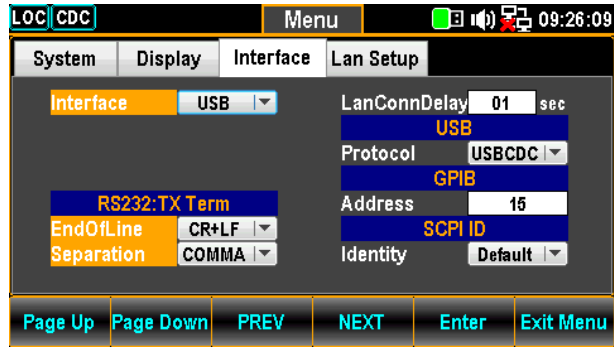

2. Press the F5 (Enter) key or Knob key followed by scrolling Knob key or pressing +/- keys to land on the USB option.

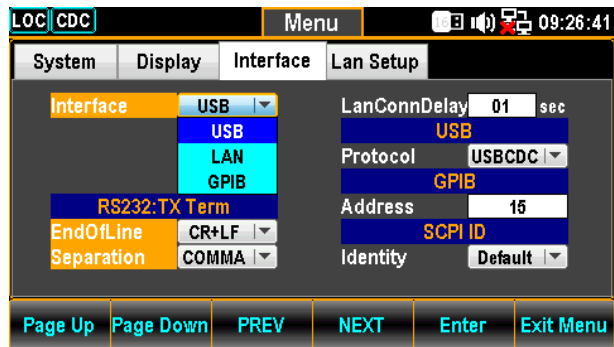
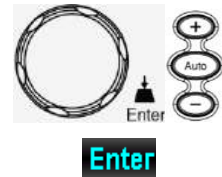

3. Press the F5 (Enter) key or Knob key to select the USB option.



4. Press the F4 (NEXT) key repeatedly or scroll the Knob key to move to the USB - Protocol field.

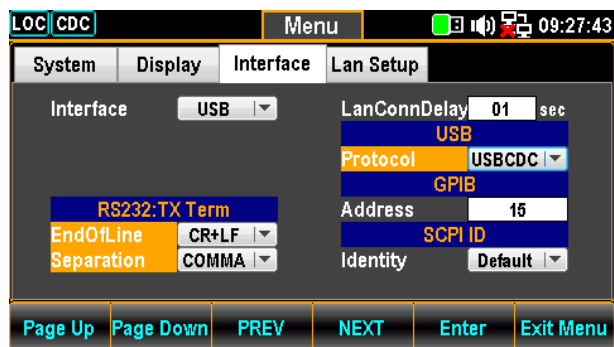
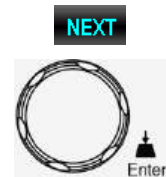

- Press the F5 (Enter) key or Knob key followed by scrolling Knob key or pressing +/- keys to land on the desired USB Protocol option.

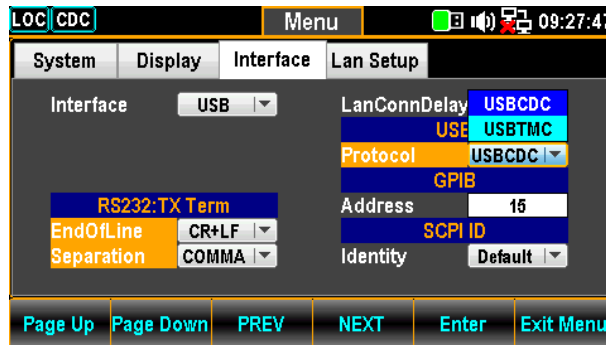
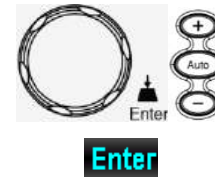

- Press the F5 (Enter) key or Knob key again to confirm the USB Protocol option.



NOTE

When “USBCDC” option is selected, user can proceed to the following RS232:TX Term relevant setting.

- Press the F4 (NEXT) key repeatedly or scroll the Knob key to move to the EndOfLine field.

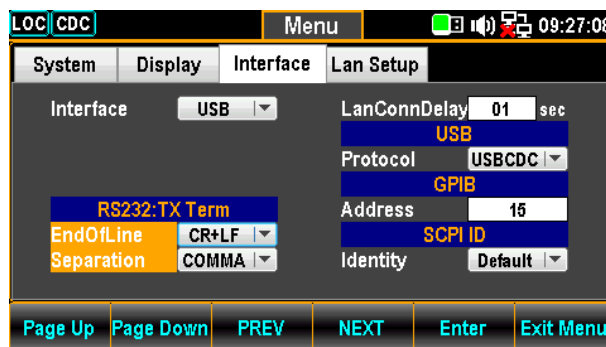

- Press the F5 (Enter) key or Knob key followed by scrolling Knob key or pressing +/- keys to land on the desired option of EndOfLine field.

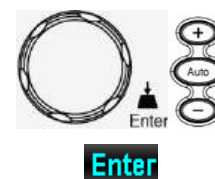

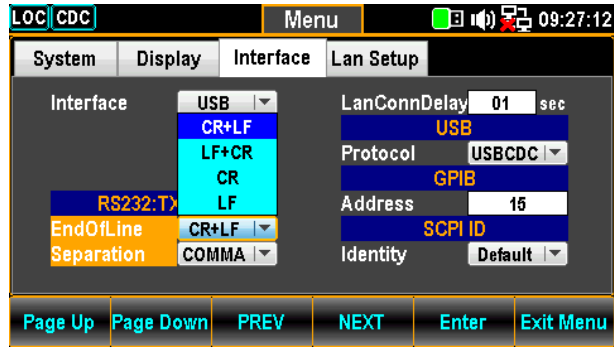

9. Press the F5 (Enter) key or Knob key again to confirm the selected option of EndOfLine field.



10. Press the F4 (NEXT) key repeatedly or scroll the Knob key to move to the Separation field.

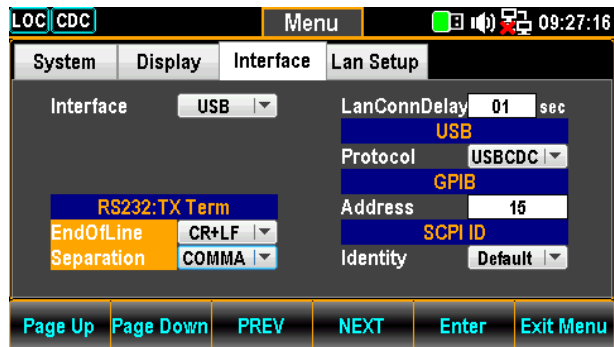

11. Press the F5 (Enter) key or Knob key followed by scrolling Knob key or pressing +/- keys to land on the desired option of Separation field.

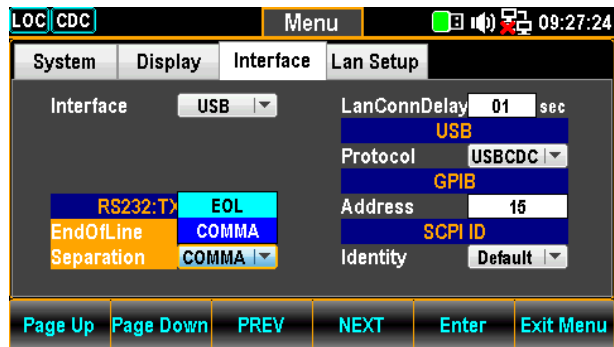
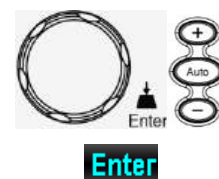

-
12. Press the F5 (Enter) key or Knob key again to confirm the selected option of Separation field.
-



13. Connect the USB cable to the rear panel terminal (upper port).
-

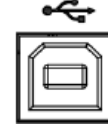

Set the USB Protocol

Description The USB device port on the rear panel is used for remote control. The USB port can be configured as either a TMC or CDC interface.

Before the DAQ-9600 can be used for remote control utilizing the CDC or TMC USB class, install the appropriate CDC or TMC USB driver included on the User Manual CD.

USBCDC:

The USB port on the DAQ-9600 will appear as a virtual COM port to a connected PC.

USBTMC:

The DAQ-9600 can be controlled using National Instruments NI-Visa software*. NI-Visa supports USB TMC.



*To use the TMC interface National Instruments Measurement and Automation Explorer can be used. This program is available on the NI website, www.ni.com, via a search for the VISA Run-time Engine page, or “downloads” at the following URL, <http://www.ni.com/visa/>

Configure GPIB Interface

GPIB Configuration Connector	24 Pin female GPIB port
Address	0-30(default 15)

- Step 1. Press the Menu key, and then the Page Down key repeatedly until the Interface configuration menu appears.

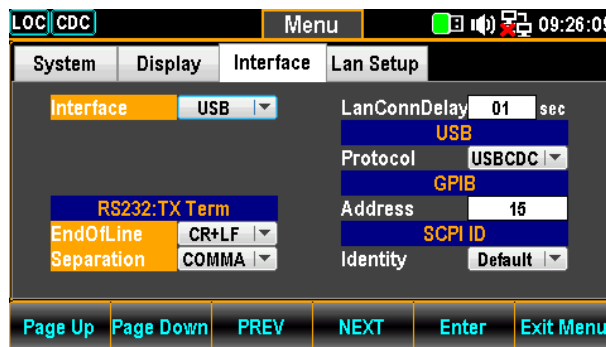
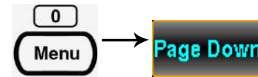

2. Press the F5 (Enter) key or Knob key followed by scrolling Knob key or pressing +/- keys to land on the GPIB option.

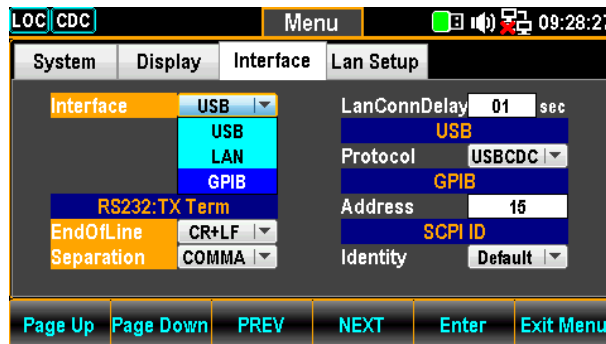
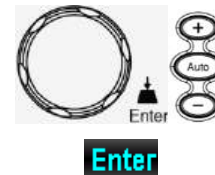

3. Press the F5 (Enter) key or Knob key to select the GPIB option.



4. Press the F4 (NEXT) key repeatedly or scroll the Knob key to move to the GPIB - Address field.



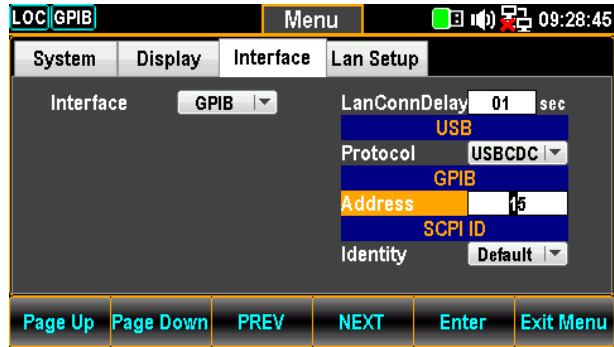

- Use the Left/Right keys to move the cursor followed by scrolling Knob key or pressing +/- keys to define GPIB Address. Also, you can press Number keys to directly input a specific digit.

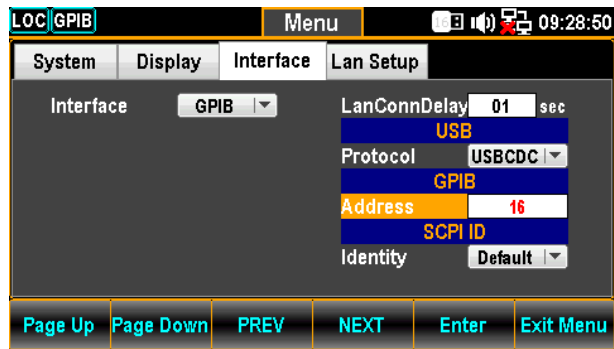
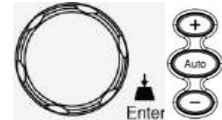

- Press the F5 (Enter) key or Knob key again to confirm the input digit for GPIB Address.

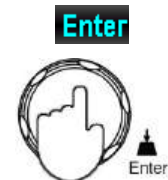

7. Connect the GPIB cable to the mini GPIB port from the rear panel of DAQ-9600.

Mini GPIB

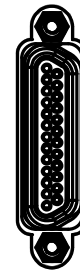

GPIB Pin Assignment	Pin	Signal	Pin	Signal
	1	Data I/O 1		
	2	Data I/O 2	14	Data I/O 6
	3	Data I/O 3	15	Data I/O 7
	4	Data I/O 4	16	Data I/O 8
	5	EOI	17	REN
	6	DAV	18	Ground (DAV)
	7	NRFD	19	Ground (NRFD)
	8	NDAC	20	Ground (NDAC)
	9	IFC	21	Ground (IFC)
	10	SRQ	22	Ground (SRQ)
	11	ATN	23	Ground (ATN)
	12	SHIELD Ground	24	Logic Ground
	13	Data I/O 5	25	NC

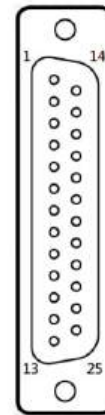

Activate Ethernet Interface

Overview

Speed

10BaseT/100BaseTx

Ethernet(LAN)
port activation

1. Press the Menu key, and then the Page Down key repeatedly until the Interface configuration menu appears.

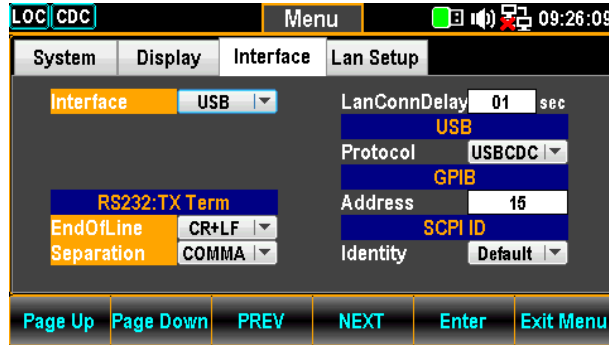

2. Press the F5 (Enter) key or Knob key followed by scrolling Knob key or pressing +/- keys to land on the LAN option.

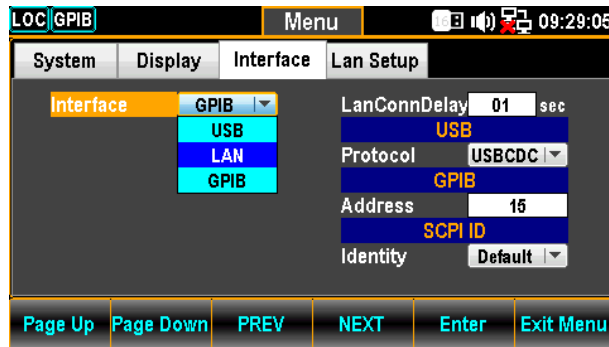
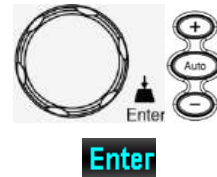

3. Press the F5 (Enter) key or Knob key to select the LAN option.



4. Connect the Ethernet cable to the rear panel Ethernet port.

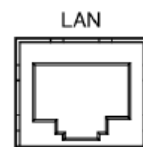

LAN Connect Delay Time

Background User is able to set a delay time in second(s) for LAN connection when booting up the DAQ-9600.

LAN Connect Delay Setting

1. Press the Menu key, and then the Page Down key repeatedly until the Interface configuration menu appears.

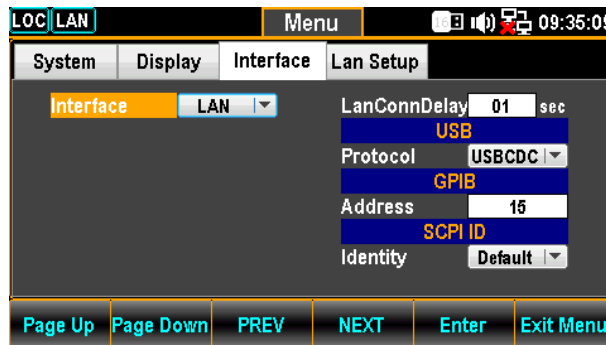
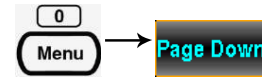

2. Press the F4 (NEXT) key repeatedly or scroll the Knob key to move to LAN Connect Delay Time.

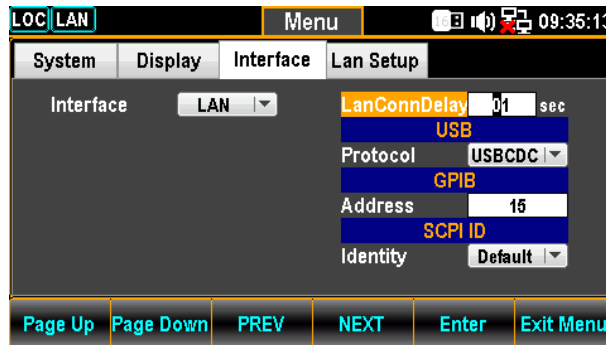
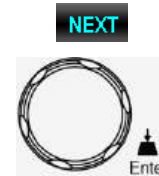

- Use the Left/Right keys to move the cursor followed by scrolling Knob key or pressing +/- keys to set LAN Connect Delay Time. Also, you can press Number keys to directly input a specific digit.

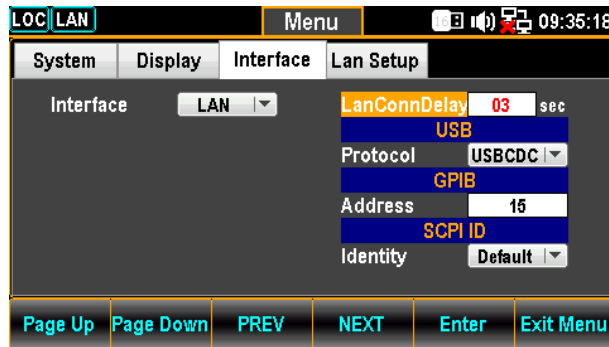
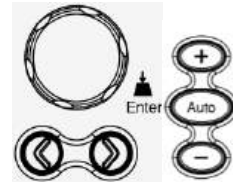

- Press the F5 (Enter) key or Knob key again to confirm the LAN Connect Delay Time.



Reboot LAN Setup

Background

To reboot is used to reset the Ethernet configuration when new settings have been made. When the Lan Setup settings have been edited, reboot to validate the changes and reset the Ethernet to the new configuration settings. New Ethernet configuration settings are only updated after the DAQ-9600 has been reset.

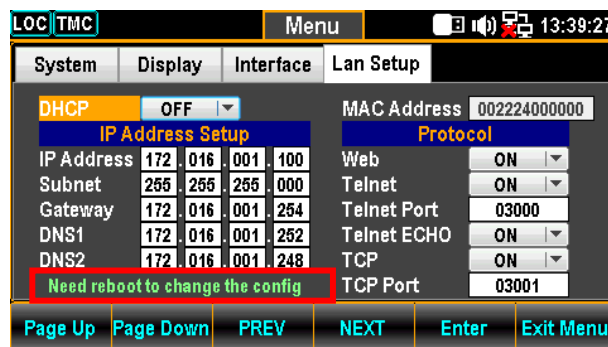

Configure Ethernet Interface to DHCP

Background The DAQ-9600 supports DHCP to have an IP address and other configuration parameters automatically assigned by a DHCP server.

DHCP Configuration

1. Press the Menu key, and then the Page Down key repeatedly until the Lan Setup configuration menu appears.

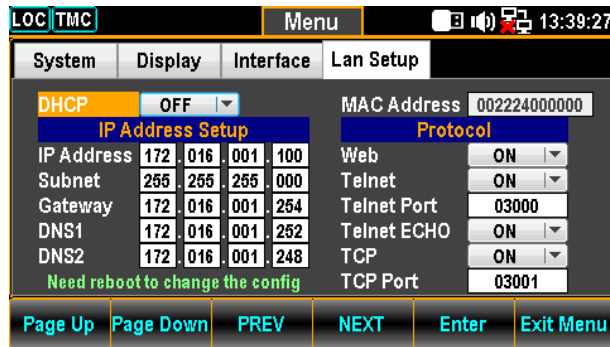
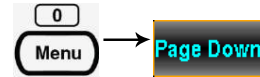

2. Press the F5 (Enter) key or Knob key followed by scrolling Knob key or pressing +/- keys to land on the ON option.

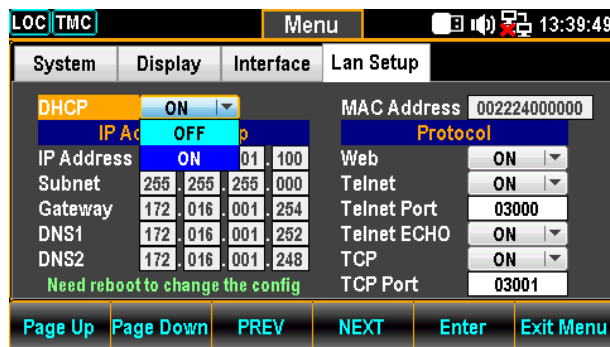
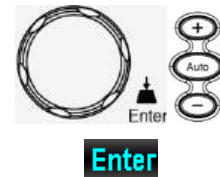

3. Press the F5 (Enter) key or Knob key to select the DHCP ON option.



Configure Ethernet IP

Background The DAQ-9600 supports manually setting of IP addresses, including the subnet mask, gateway, DNS1 and DNS2.



NOTE

The IP Address Setup can only be edited if DHCP is off.

IP Address Configuration

1. Press the Menu key, and then the Page Down key repeatedly until the Lan Setup configuration menu appears.

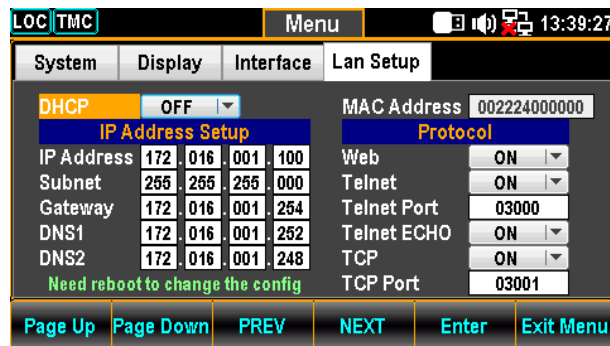
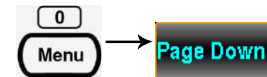

2. Press the F4 (NEXT) key repeatedly or scroll the Knob key to move to the IP Address Setup – IP Address field.

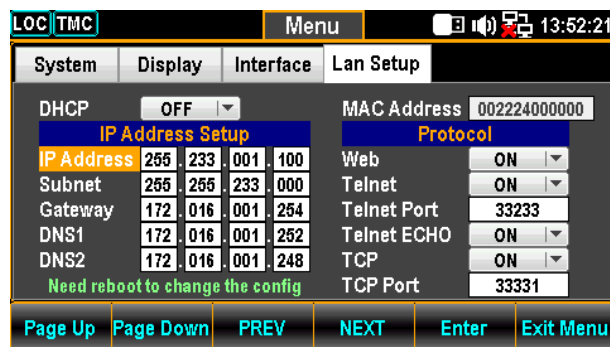
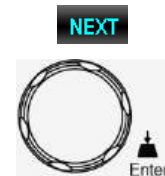

- Use the Left/Right keys to move the cursor followed by scrolling Knob key or pressing +/- keys to define IP Address. Also, you can press Number keys to directly input a specific digit.

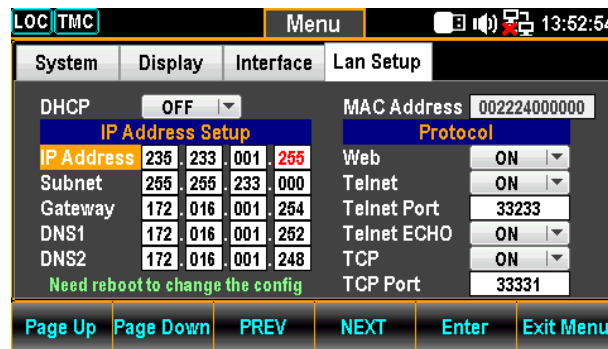
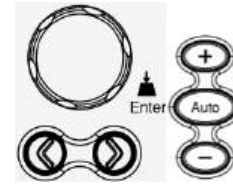

- Press the F5 (Enter) key or Knob key to confirm the input digit for IP1 Address. And the cursor will automatically jump to next groups.



- Repeat the steps 3 to 4 for IP2, IP3 and IP4.



NOTE

The IP address is divided in 4 groups; IP1:IP2:IP3:IP4.

Subnet Configuration

- Press the F4 (NEXT) key repeatedly or scroll the Knob key to move to the IP Address Setup – Subnet field.

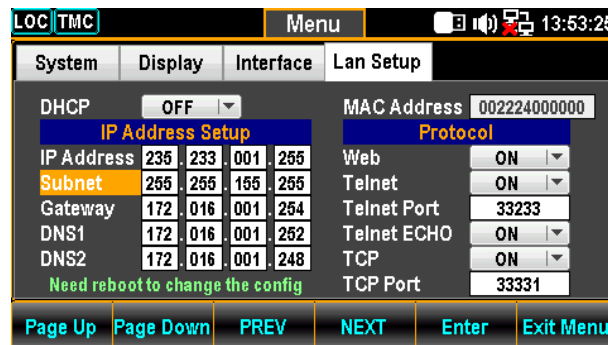

- Use the Left/Right keys to move the cursor followed by scrolling Knob key or pressing +/- keys to define Subnet. Also, you can press Number keys to directly input a specific digit.

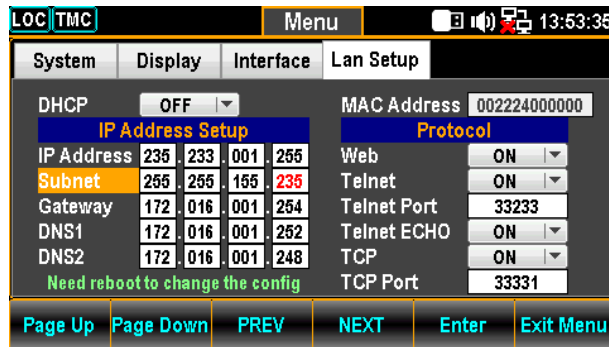
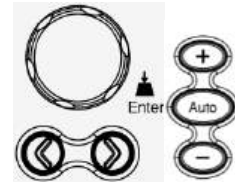

- Press the F5 (Enter) key or Knob key again to confirm the input digit for S1. And the cursor will automatically jump to next groups.



- Repeat steps 7 to 8 for S2, S3 and S4.



NOTE

The Subnet is divided in 4 groups; S1:S2:S3:S4.

Gateway Configuration

- Press the F4 (NEXT) key repeatedly or scroll the Knob key to move to the IP Address Setup – Gateway field.

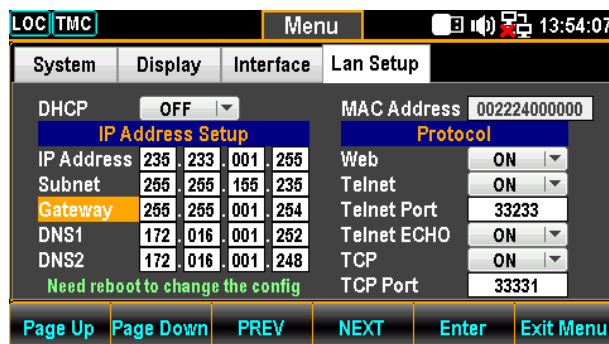

- Use the Left/Right keys to move the cursor followed by scrolling Knob key or pressing +/- keys to define Gateway. Also, you can press Number keys to directly input a specific digit.

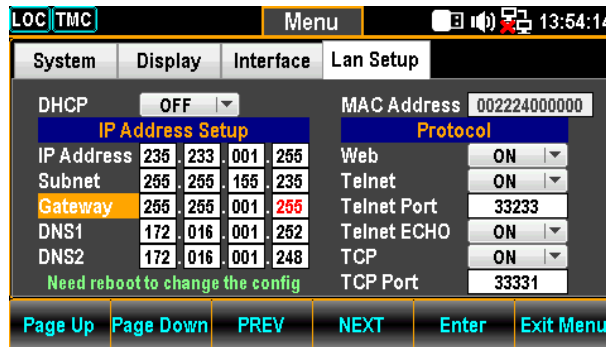
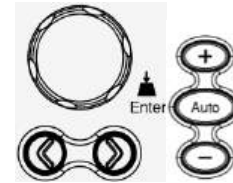

- Press the F5 (Enter) key or Knob key to confirm the input digit for G1. And the cursor will automatically jump to next groups.



- Repeat steps 11 to 12 for G2, G3 and G4.



NOTE

The Gateway is divided in 4 groups; G1:G2:G3:G4.

DNS1 Configuration

- Press the F4 (NEXT) key repeatedly or scroll the Knob key to move to the IP Address Setup – DNS1 field.

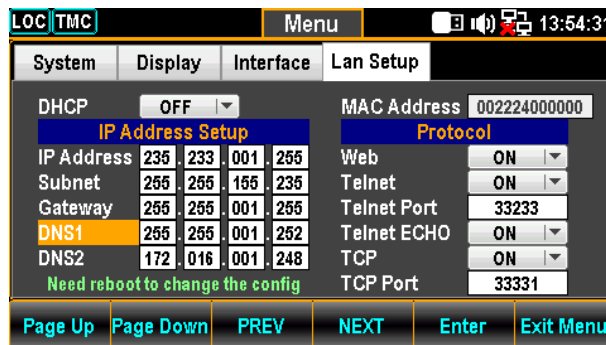

15. Use the Left/Right keys to move the cursor followed by scrolling Knob key or pressing +/- keys to define DNS1. Also, you can press Number keys to directly input a specific digit.

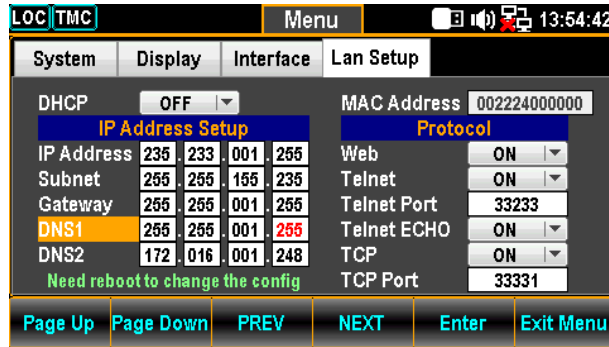
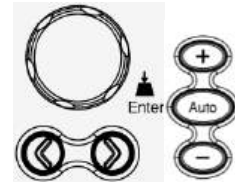

16. Press the F5 (Enter) key or Knob key again to confirm the input digit for D11. And the cursor will automatically jump to next groups.



17. Repeat steps 15 to 16 for D12, D13 and D14.



NOTE

The Gateway is divided in 4 groups; D11:D12:D13:D14.

DNS2 Configuration

18. Press the F4 (NEXT) key repeatedly or scroll the Knob key to move to the IP Address Setup – DNS2 field.

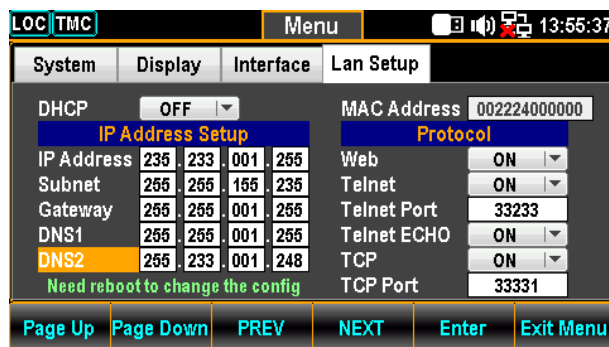
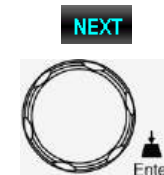

19. Use the Left/Right keys to move the cursor followed by scrolling Knob key or pressing +/- keys to define DNS2. Also, you can press Number keys to directly input a specific digit.

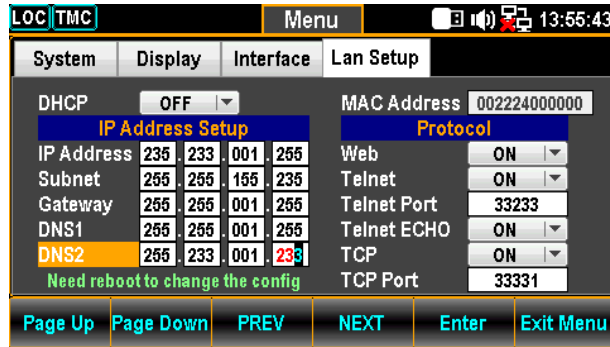
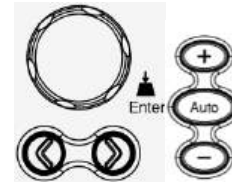

20. Press the F5 (Enter) key or Knob key again to confirm the input digit for D21. And the cursor will automatically jump to next groups.



21. Repeat steps 20 to 21 for D22, D23 and D24.



The Gateway is divided in 4 groups; D21:D22:D23:D24.

Configure Protocol

Background The DAQ-9600 supports 3 Ethernet protocol to used, including the Web browser, Telnet and TCP.

Web Configuration

1. Press the Menu key, and then the Page Down key repeatedly until the Lan Setup configuration menu appears.

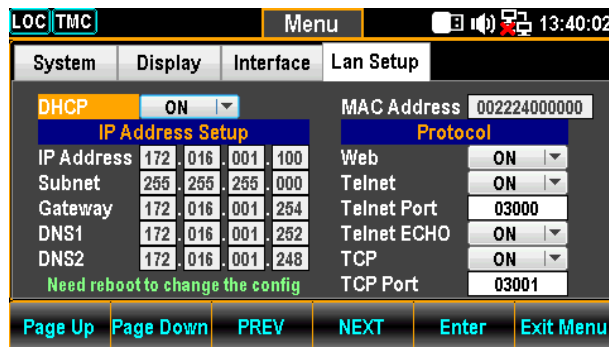
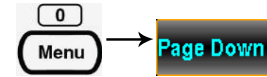

2. Press the F4 (NEXT) key repeatedly or scroll the Knob key to move to the Protocol – Web field.

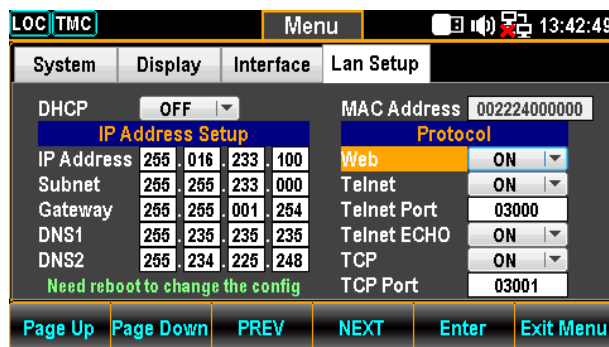

3. Press the F5 (Enter) key or Knob key followed by scrolling Knob key or pressing +/- keys to land on the ON option.

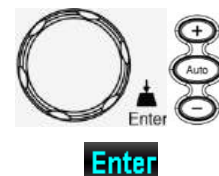

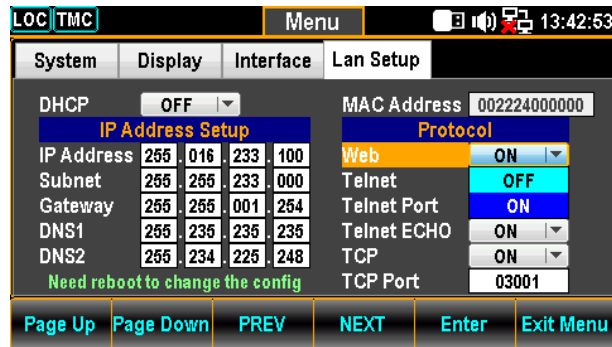

4. Press the F5 (Enter) key or Knob key to confirm the Web ON option.

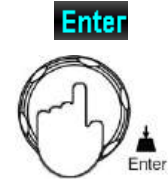

Telnet Configuration

5. Press the F4 (NEXT) key repeatedly or scroll the Knob key to move to the Protocol – Telnet field.

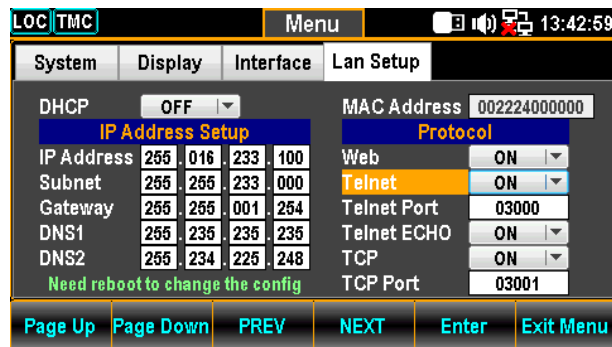

6. Press the F5 (Enter) key or Knob key followed by scrolling Knob key or pressing +/- keys to land on the ON option.

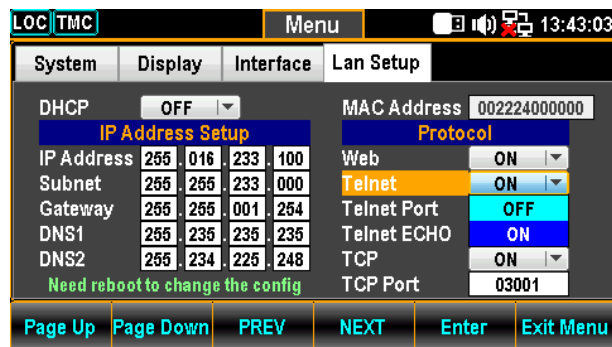
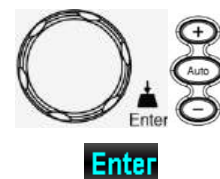

- Press the F5 (Enter) key or Knob key to confirm the Telnet ON option.

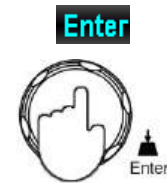

Telnet Port Configuration

- Press the F4 (NEXT) key repeatedly or scroll the Knob key to move to the Protocol – Telnet Port field.

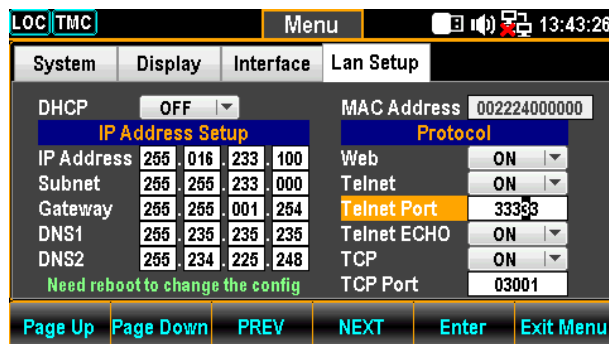
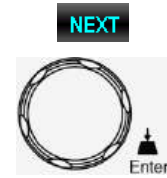

- Use the Left/Right keys to move the cursor followed by scrolling Knob key or pressing +/- keys to define Telnet Port. Also, you can press Number keys to directly input a specific digit.

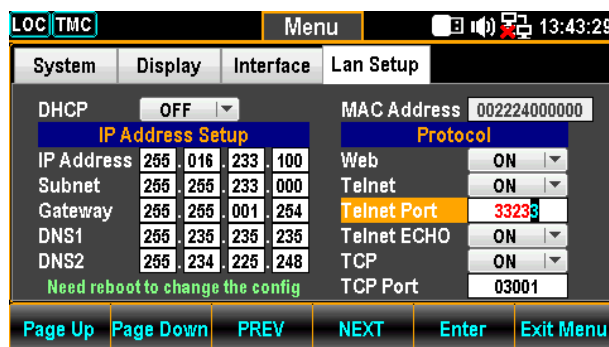
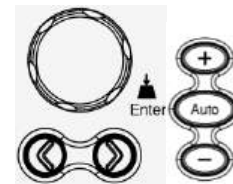

- Press the F5 (Enter) key or Knob key to confirm the input digit for Telnet Port.

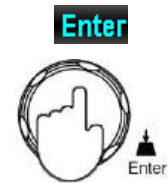

Range 1024~65535 (Default = 5024)

Telnet ECHO Configuration

- Press the F4 (NEXT) key repeatedly or scroll the Knob key to move to the Protocol – Telnet ECHO field.

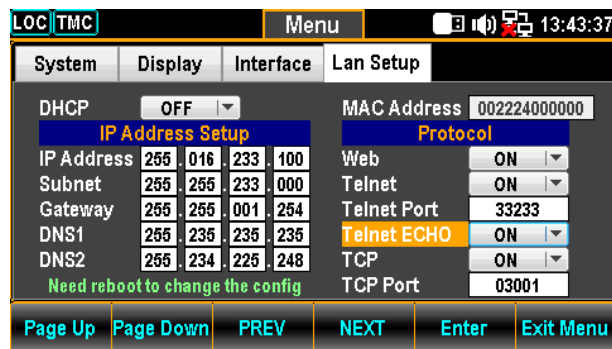
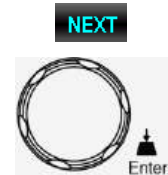

- Press the F5 (Enter) key or Knob key followed by scrolling Knob key or pressing +/- keys to land on the ON option.

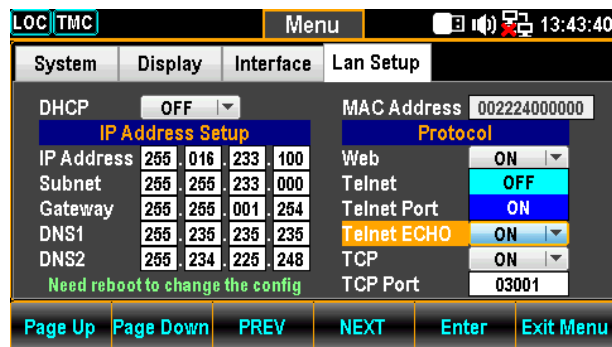
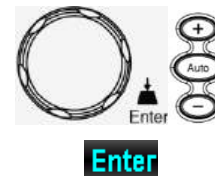

13. Press the F5 (Enter) key or Knob key again to confirm the Telnet ECHO ON option.

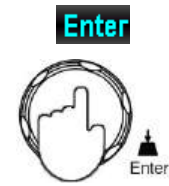

TCP Configuration

14. Press the F4 (NEXT) key repeatedly or scroll the Knob key to move to the Protocol - TCP field.

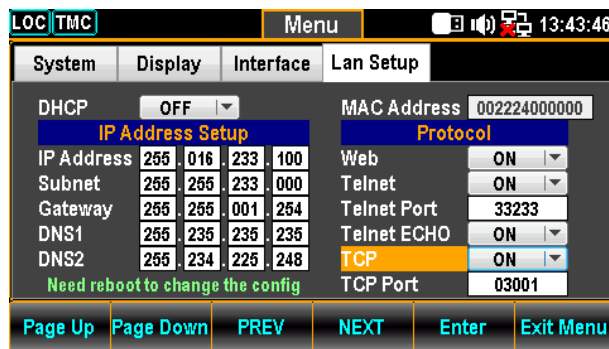
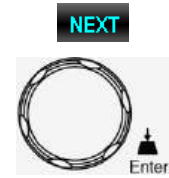

15. Press the F5 (Enter) key or Knob key followed by scrolling Knob key or pressing +/- keys to land on the ON option.

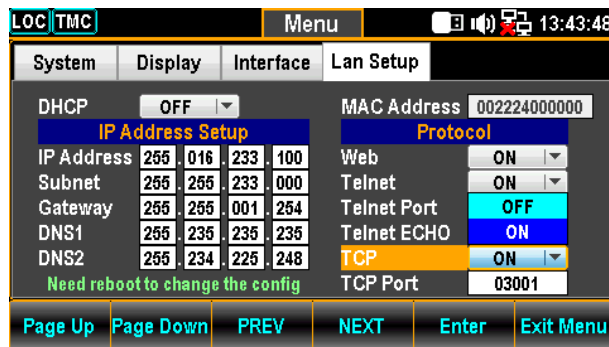
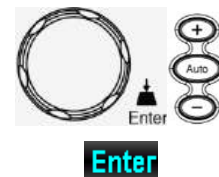

16. Press the F5 (Enter) key or Knob key again to confirm the TCP ON option

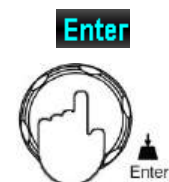

TCP Port Configuration

17. Press the F4 (NEXT) key repeatedly or scroll the Knob key to move to the Protocol - TCP Port field.



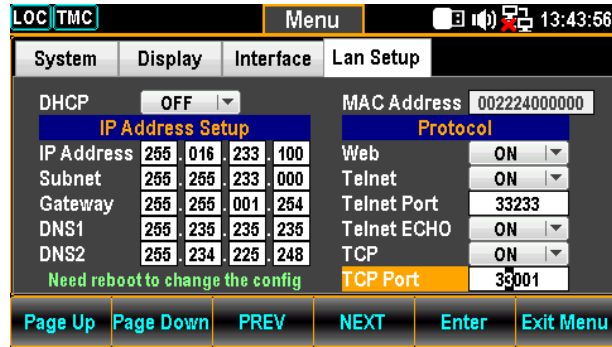

18. Use the Left/Right keys to move the cursor followed by scrolling Knob key or pressing +/- keys to define TCP Port. Also, you can press Number keys to directly input a specific digit.

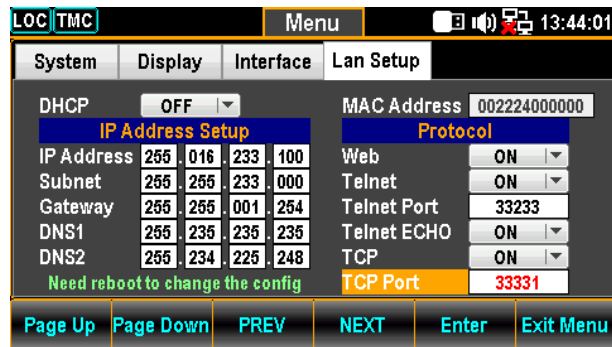
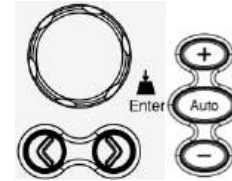

Range 1024~65535 (Default = 5025)

19. Press the F5 (Enter) key or Knob key again to confirm the input digit for TCP Port.



Remote Terminal Session (Telnet / TCP)

Background	A terminal application can be used to remotely control the DAQ-9600 via the Telnet or TCP protocol.
Operation	<ol style="list-style-type: none">1. Establish a connection via the Ethernet port.2. Open a terminal program such as Hyper Terminal and enter the IP address and port number of the DAQ-9600.3. Run this query via the terminal application: *idn? The command will return the instrument manufacturer, model number, serial number and firmware version in the following format: >GWInstek,DAQ9600,000000000,M0.69B_S0.25B4. See page 214 for more details on remote commands.

Web Control Interface

The web control interface is accessible with the standard Ethernet port. The web control interface allows remote access over LAN using a Java-enabled web browser (Java only applicable to Internet Explorer).

The web control interface allows a web browser to modify parameter settings, remotely operate, control and monitor the DAQ-9600.

Telnet and TCP parameters can also be edited by using the web control interface so that applets such as HyperTerminal or Telnet can be used to monitor measurement readings, control settings and run programs utilizing the same remote control command set used with the RS232 remote control.

Background Before trying to access the web browser control interface, please ensure your browser has JavaScript enabled.

- Step 1 - Connection**
1. Configure the LAN interface and connect the DAQ-9600 to the LAN..
 2. Enter the IP address of the DAQ-9600 in the address field of the web browser.
 3. The web control Welcome Page appears.



DAQ-9600 Welcome Page

- Step 2 - Web Control**
1. To start web control, click on the Web Control icon.



2. The control panel display, which is identical to that of the physical DAQ-9600, appears.



Step 2-1 - Configuration

3. Set the basic operations and monitor measurement readings, and press apply button to enable the control settings when parameters have been changed.
4. Proceed to operation settings in the way similar to operations on the physical DAQ-9600.



Step 3 - View and Modify LAN Configuration

The current Ethernet settings can be viewed and modified from the web control interface.

1. To edit or view the current configuration settings, click on the View & Modify Configuration icon.
2. The configuration settings appear.



Miscellaneous Settings

Name:	DAQ
Serial Number:	GRD332211
Master Firmware:	0.89
Slave Firmware:	0.95
IP Address:	192.168.31.80
MAC Address:	00-22-24-33-22-11

IP Address Settings

Address Type:	DHCP <input type="button" value="v"/>														
Static IP Address:	192	.	168	.	31	.	80								
Subnet Mask:	255	.	255	.	248	.	0								
Default Gateway:	192	.	168	.	31	.	254								
DNS:	172	.	16	.	1	.	248	,	172	.	16	.	1	.	252
<input type="button" value="Update Settings"/>															

General Configuration Settings

Module Name:	DAQ <input type="text"/>	
TCP Enable:	ON <input type="button" value="v"/>	
TCP port number:	<input type="text" value="3001"/>	(1024~65535)
Telnet Enable:	ON <input type="button" value="v"/>	
Telnet port number:	<input type="text" value="3000"/>	(1024~65535)
Telnet ECHO:	ON <input type="button" value="v"/>	
Telnet Timeout:	<input type="text" value="0"/>	seconds(0 for no timeout)
<input type="button" value="Update Settings"/>		

Password Modify

Old Password:	<input type="text"/>	(4-8 characters numeric)
New Password:	<input type="text"/>	(4-8 characters numeric)
Confirm Password:	<input type="text"/>	
<input type="button" value="Modify"/>		

Restore Factory Defaults

Restore all options to their factory default states:	<input type="button" value="Restore Defaults"/>
--	---

DAQ Reset

DAQ need Reset If Parameter has Change:	<input type="button" value="Reset"/>
---	--------------------------------------

3. The View & Modify Configuration page allows you to:
 - View the instrument name, firmware revision of the Ethernet card, IP address and MAC address.
 - Set the IP address to DHCP or static.
 - Configure the module host name and the parameters of TCP & telnet.
 - Modify the web password.
 - Restore the Ethernet to the factory default settings (equivalent to the INIT function).
 - Reset: reboot to make the new setting take effect when any parameter is modified.

Command Syntax

Compatible Standard	IEEE488.2	Partial compatibility
	SCPI, 1994	Partial compatibility

Command Structure SCPI (Standard Commands for Programmable Instruments) commands follow a tree-like structure, organized into nodes. Each level of the command tree is a node. Each keyword in a SCPI command represents each node in the command tree. Each keyword (node) of a SCPI command is separated by a colon (:).

For example, the diagram below shows an SCPI sub-structure and a command example.

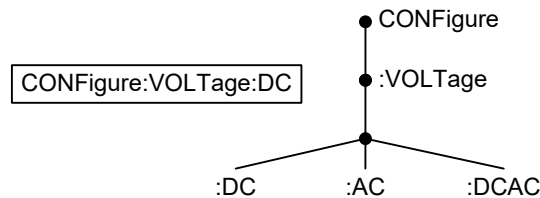

Command Types There are a number of different instrument commands and queries. A command sends instructions or data to the unit and a query receives data or status information from the unit.

Command types

Simple A single command with/without a parameter

Example CONFigure:VOLTagE:DC

Query A query is a simple or compound command followed by a question mark (?). A parameter (data) is returned.

Example CONFigure:RANGe?

Command Forms Commands and queries have two different forms, long and short. The command syntax is written with the short form of the command in capitals and the remainder (long form) in lower case.

The commands can be written either in capitals or lower-case, just so long as the short or long forms are complete. An incomplete command will not be recognized.

Below are examples of correctly written commands.

Long form
 CONFigure:DIODe
 CONFIGURE:DIODE
 Configure:diode

Short form
 CONF:DIOD
 conf:diod

Square Brackets

Commands that contain square brackets indicate that the contents are optional. The function of the command is the same with or without the square bracketed items, as shown below. For example, for the query:

[SENSe:]UNIT?

Both SENSE:UNIT? and UNIT? are valid forms.

Command Format

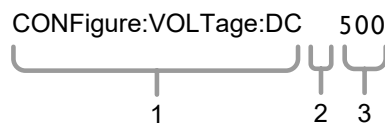

- 1. Command header
- 2. Space
- 3. Parameter 1

Common Input Parameters

Type	Description	Example
<Boolean>	boolean logic	0, 1
<NR1>	integers	0, 1, 2, 3
<NR2>	decimal numbers	0.1, 3.14, 8.5
<NR3>	floating point with exponent	4.5e-1, 8.25e+1
<NRf>	any of NR1, 2, 3	1, 1.5, 4.5e-1
[MIN] (Optional parameter)	For commands, this will set the setting to the lowest value. This parameter can be used in place of any numerical parameter where indicated. For queries, it will return the lowest possible value allowed for the particular setting.	

[MAX] (Optional parameter)	For commands, this will set the setting to the highest value. This parameter can be used in place of any numerical parameter where indicated.
	For queries, it will return the highest possible value allowed for the particular setting.
DEF	For commands, this will set the setting to the default value. This parameter can be used in place of any numerical parameter where indicated.
	For queries, it will return the default value allowed for the particular setting.
Automatic parameter range selection	The DAQ-9600 automatically sets the command parameter to the next available value.
Example	<p>conf:volt:dc 3</p> <p>This will set the measurement item to DC Voltage and the range to 10V. There is no 3V range so the DMM selects the next available range, 10V.</p>
Message Terminator (EOL)	<p>Remote Command</p> <p>Marks the end of a command line. The following messages are in accordance with IEEE488.2 standard.</p> <p>LF, CR, CR+LF, LF+CR</p> <p>The most common EOL character is CR+LF</p>
Message Separator	<p>EOL or ; (semicolon)</p> <p>Command Separator</p>

Command Set

Other Commands

ABORt.....	227
FETCh?	227
INITiate[:IMMediate]	228
INSTrument:DMM	228
R?	229
READ?	230
TIME:SYNC:SERVer	230
UNIT:TEMPerature	231

CALCulate Commands

CALCulate:AVERage:ALL?	231
CALCulate:AVERage:{AVERage MAXimum MINimum PTPeak SDEviation}?	232
CALCulate:AVERage:CLear	232
CALCulate:AVERage:COUNT?	232
CALCulate:AVERage:{MAXimum MINimum}:TIME?	233
CALCulate:LIMit:{LOWer UPPer}	233
CALCulate:LIMit:{LOWer UPPer}:STATe	234
CALCulate:MATH	235
CALCulate:SCALE:DB:REFerence	236
CALCulate:SCALE:DBM:REFerence	236
CALCulate:SCALE:DECimal:POINt	236
CALCulate:SCALE:FUNCTion	237
CALCulate:SCALE:GAIN	237
CALCulate:SCALE:OFFSet	237
CALCulate:SCALE:OFFSet:NULL	238
CALCulate:SCALE:PERCent	238
CALCulate:SCALE:REFerence	238
CALCulate:SCALE:REFerence:AUTO	239
CALCulate:SCALE:REFerence:IMMediate	239
CALCulate:SCALE[:STATe]	239
CALCulate:SCALE:UNIT	240
CALCulate:SCALE:UNIT:STATe	240

CONFigure Commands

CONFigure?	240
CONFigure:CAPacitance	241
CONFigure:CURRent:{AC DC}	241
CONFigure:DIODE	241
CONFigure:{FREQuency PERiod}	242
CONFigure:{RESistance FRESistance}	242
CONFigure:STRain:{DIRect FDIRect}	243
CONFigure:STRain:{FULL HALF}:BENDing	243
CONFigure:STRain:{FULL HALF}:POISson	243
CONFigure:STRain:FULL:BENDing:POISson	244
CONFigure:STRain:QUARter	244
CONFigure:TEMPerature	244
CONFigure[:VOLTage]:{AC DC}	245

DATA Commands

DATA:LAST?	245
DATA:POINts?	246
DATA:POINts:EVENT:THReshold	246
DATA:REMOve?	247

DIGital INTerface Commands

DIGital:INTerface:MODE	248
DIGital:INTerface:DATA:OUTPut	248
DIGital:INTerface:DATA:SETup	248

DISPlay Commands

DISPlay	249
DISPlay:TEXT	249
DISPlay:TEXT:CLEar	249

FORMat Commands

FORMat:READing:ALARm.....	250
FORMat:READing:CHANnel	250
FORMat:READing:TIME	250
FORMat:READing:TIME:TYPE	251
FORMat:READing:UNIT	251

HCOPY Commands

HCOPY:SDUMp:DATA?	252
-------------------------	-----

MEASure Commands

MEASure:CAPacitance?	253
MEASure:CURRent:{AC DC}?.....	253
MEASure:DIODE?	254
MEASure:{FREQuency PERiod}?.....	254
MEASure:{RESistance FRESistance}?	255
MEASure:STRain:{DIRect FDIRect}?.....	255
MEASure:STRain:{FULL HALF}:BENDing?	256
MEASure:STRain:{FULL HALF}:POISSon?	256
MEASure:STRain:FULL:BENDing:POISSon?	257
MEASure:STRain:QUARter?	257
MEASure:TEMPerature?	258
MEASure[:VOLTage]:{AC DC}?	258

MMEMory Commands

MMEMory:FORMat:READing:CHEAder	259
MMEMory:FORMat:READing:CSEParator	259
MMEMory:FORMat:READing:RLIMit	259
MMEMory:FORMat:READing:RLIMit:COUNT.....	260
MMEMory:LOG[:ENABle]	260

Output Commands

OUTPut:ALARm:CLEAr:ALL	261
OUTPut:ALARm{1 2 3 4}:CLEAr	261
OUTPut:ALARm{1 2 3 4}:SOURce	262
OUTPut:ALARm:MODE	262
OUTPut:ALARm:SLOPe	263
OUTPut:TRIGger:SLOPe	263

ROUTE Commands

ROUTE:CHANnel:ADVance:SOURce	264
ROUTE:CHANnel:DELay	264
ROUTE:CHANnel:DELay:AUTO	265
ROUTE:CHANnel:FWIRe	265
ROUTE:CHANnel:LABel	266
ROUTE:CHANnel:LABel:CLEAr:MODule	266
ROUTE:CLOSe	267
ROUTE:CLOSe:EXCLusive	267
ROUTE:DONE?	268
ROUTE:MONitor	268
ROUTE:MONitor:DATA?	269
ROUTE:MONitor:DATA:FULL?	269
ROUTE:MONitor:STATe	270
ROUTE:MONitor:VIEW	270
ROUTE:OPEN	271
ROUTE:SCAN	271
ROUTE:SCAN:SIZE?	272

SENSE Related Commands

[SENSe:]FUNctIon[:ON]	273
-----------------------------	-----

SENSE AVERAge Commands

[SENSe:]AVERAge:COUNt.....	273
[SENSe:]AVERAge:STATe	274
[SENSe:]AVERAge:WINDow.....	274
[SENSe:]AVERAge:WINDow:METHod.....	274

SENSE CAPacitance Commands

[SENSe:]CAPacitance:RANGe.....	275
[SENSe:]CAPacitance:RANGe:AUTO.....	275

SENSE CURRent Commands

[SENSe:]CURRent:AC:BANDwidth	276
[SENSe:]CURRent:{AC DC}:RANGe	276
[SENSe:]CURRent:{AC DC}:RANGe:AUTO.....	277
[SENSe:]CURRent:{AC DC}:RANGe:LOW.....	277
[SENSe:]CURRent[:DC]:APERture	278
[SENSe:]CURRent[:DC]:APERture:ENABLE	278
[SENSe:]CURRent[:DC]:NPLCycles	279
[SENSe:]CURRent[:DC]:ZERO:AUTO	279

SENSE DIODE Commands

[SENSe:]DIODE:ZERO:AUTO.....	280
------------------------------	-----

SENSE FREQuency Commands

[SENSe:]{FREQuency PERiod}:APERture	280
[SENSe:]{FREQuency PERiod}:RANGe:LOWer.....	281
[SENSe:]{FREQuency PERiod}:TIMeout:AUTO	281
[SENSe:]{FREQuency PERiod}:VOLTage:RANGe.....	282
[SENSe:]{FREQuency PERiod}:VOLTage:RANGe:AUTO	282

SENSe RESistance Commands

[SENSe:]{RESistance FRESistance}:APERture.....	283
[SENSe:]{RESistance FRESistance}:APERture:ENABLE.....	283
[SENSe:]{RESistance FRESistance}:NPLCycles.....	284
[SENSe:]{RESistance FRESistance}:OCOMPensated.....	284
[SENSe:]{RESistance FRESistance}:POWER:LIMit[:STATe].....	285
[SENSe:]{RESistance FRESistance}:RANGe.....	285
[SENSe:]{RESistance FRESistance}:RANGe:AUTO.....	286
[SENSe:]{RESistance FRESistance}:ZERO:AUTO.....	286

SENSe STRain Commands

[SENSe:]STRain:APERture.....	287
[SENSe:]STRain:APERture:ENABLE.....	287
[SENSe:]STRain:EXCitation.....	288
[SENSe:]STRain:EXCitation:TYPE.....	288
[SENSe:]STRain:GFACtor.....	289
[SENSe:]STRain:NPLCycles.....	289
[SENSe:]STRain:OCOMPensated.....	290
[SENSe:]STRain:POISson.....	290
[SENSe:]STRain:RESistance.....	291
[SENSe:]STRain:UNSTrained.....	291
[SENSe:]STRain:UNSTrained:IMMEDIATE.....	292
[SENSe:]STRain:VOLTagE:RANGe.....	292
[SENSe:]STRain:VOLTagE:RANGe:AUTO.....	292
[SENSe:]STRain:ZERO:AUTO.....	293

SENSe TEMPerature Commands

[SENSe:]TEMPerature:APERture.....	293
[SENSe:]TEMPerature:APERture:ENABLE.....	294
[SENSe:]TEMPerature:NPLCycles.....	294
[SENSe:]TEMPerature:RJUNction?.....	294
[SENSe:]TEMPerature:RJUNction:SIMulated:AUTO:OFFSet.....	295
[SENSe:]TEMPerature:TRANSDUCER:{RTD FRTD}:TYPE.....	295

[SENSe:]TEMPerature:TRANsducer:{RTD FRTD}:USER:ALPHA.....	295
[SENSe:]TEMPerature:TRANsducer:{RTD FRTD}:USER:BETA	296
[SENSe:]TEMPerature:TRANsducer:{RTD FRTD}:USER:DELTA.....	296
[SENSe:]TEMPerature:TRANsducer:{RTD FRTD}:OCOMpensated	297
[SENSe:]TEMPerature:TRANsducer:{RTD FRTD}:POWER:LIMit[:STATe]	297
[SENSe:]TEMPerature:TRANsducer:{RTD FRTD}:REFerence	298
[SENSe:]TEMPerature:TRANsducer:{RTD FRTD}:RESistance[:REFerence]	298
[SENSe:]TEMPerature:TRANsducer:{THERmistor FTHermistor}:POWER:LI Mit[:STATe].....	299
[SENSe:]TEMPerature:TRANsducer:{THERmistor FTHermistor}:REFerenc e	299
[SENSe:]TEMPerature:TRANsducer:{THERmistor FTHermistor}:TYPE	300
[SENSe:]TEMPerature:TRANsducer:{THERmistor FTHermistor}:USER:AV ALue.....	300
[SENSe:]TEMPerature:TRANsducer:{THERmistor FTHermistor}:USER:BV ALue.....	301
[SENSe:]TEMPerature:TRANsducer:{THERmistor FTHermistor}:USER:CV ALue.....	301
[SENSe:]TEMPerature:TRANsducer:TCouple:CHECK.....	302
[SENSe:]TEMPerature:TRANsducer:TCouple:RJUNction	302
[SENSe:]TEMPerature:TRANsducer:TCouple:RJUNction:TYPE	303
[SENSe:]TEMPerature:TRANsducer:TCouple:TYPE	303
[SENSe:]TEMPerature:TRANsducer:TYPE.....	303
[SENSe:]TEMPerature:ZERO:AUTO	304

SENSe VOLTage Commands

[SENSe:]VOLTage:AC:BANDwidth	304
[SENSe:]VOLTage:{AC DC}:RANGe.....	305
[SENSe:]VOLTage:{AC DC}:RANGe:AUTO	305
[SENSe:]VOLTage[:DC]:APERture	306
[SENSe:]VOLTage[:DC]:APERture:ENABLE	306
[SENSe:]VOLTage[:DC]:IMPedance:AUTO	307
[SENSe:]VOLTage[:DC]:NPLCycles.....	307
[SENSe:]VOLTage[:DC]:REFerence	308
[SENSe:]VOLTage[:DC]:ZERO:AUTO	308

STATus Report Commands

STATus:ALARm:CONDition?	309
STATus:ALARm:ENABle	309
STATus:ALARm[:EVENT]?	310
STATus:OPERation:CONDition?	310
STATus:OPERation:ENABle	310
STATus:OPERation[:EVENT]?	311
STATus:PRESet	311
STATus:QUEStionable:CONDition?	311
STATus:QUEStionable:ENABle	312
STATus:QUEStionable[:EVENT]?	312

SYSTem Related Commands

SYSTem:ALARm?	313
SYSTem:BEEPer[:IMMediate]	313
SYSTem:BEEPer:ERRor	314
SYSTem:BEEPer:STATe	314
SYSTem:CLICk:STATe	314
SYSTem:CPON	315
SYSTem:CTYPe?	315
SYSTem:DATE	315
SYSTem:ERRor?	315
SYSTem:LFRequency?	315
SYSTem:LOCal	316
SYSTem:REMote	316
SYSTem:PARAmeter:LOAD	316
SYSTem:PARAmeter:SAVE	316
SYSTem:PERSONa[:MANUFACTurer]	316
SYSTem:PERSONa[:MANUFACTurer]:DEFault	317
SYSTem:PERSONa:MODEl	317
SYSTem:PERSONa:MODEl:DEFault	317
SYSTem:PRESet	317
SYSTem:RELay:CYCLes?	318
SYSTem:RELay:CYCLes:CLEar	318
SYSTem:RELay:CYCLes:FACTory?	318

SYSTem:SCPi:MODE	319
SYSTem:SCPi:AUTO:SAVE	319
SYSTem:SERial?	319
SYSTem:SLOT:LABel	320
SYSTem:TEMPerature?	320
SYSTem:TIME	320
SYSTem:TIME:SCAN?	320
SYSTem:UPTime?	321
SYSTem:VERSiOn?	321
SYSTem:WMESsage	321

SYSTem COMMunication Commands

SYSTem:COMMunicate:GPIB:ADDRes	322
SYSTem:COMMunicate:LAN:DHCP	322
SYSTem:COMMunicate:LAN:DNS[X]	322
SYSTem:COMMunicate:LAN:DOMain?	323
SYSTem:COMMunicate:LAN:GATeway	323
SYSTem:COMMunicate:LAN:HOSTName	323
SYSTem:COMMunicate:LAN:IPADdress	324
SYSTem:COMMunicate:LAN:MAC?	324
SYSTem:COMMunicate:LAN:SMASk	324
SYSTem:COMMunicate:LAN:TCP:ENABLE	325
SYSTem:COMMunicate:LAN:TCP:PORT	325
SYSTem:COMMunicate:LAN:TELNet:ECHO	325
SYSTem:COMMunicate:LAN:TELNet:ENABLE	326
SYSTem:COMMunicate:LAN:TELNet:TIMeout	326
SYSTem:COMMunicate:LAN:TELNet:PORT	326
SYSTem:COMMunicate:LAN:TELNet:PROMpt	327
SYSTem:COMMunicate:LAN:TELNet:WMESsage	327
SYSTem:COMMunicate:LAN:TIMeout	327
SYSTem:COMMunicate:LAN:UPDate	328
SYSTem:COMMunicate:LAN:WEB:ENABLE	328
SYSTem:COMMunicate:LAN:WINS	328

TRIGger Commands

TRIGger:COUNT	329
TRIGger:SLOPe	329
TRIGger:SOURce.....	330
TRIGger:TIMer	331

IEEE 488.2 Common Commands

*CLS.....	332
*ESE.....	332
*ESR?	332
*IDN?	333
*OPC.....	333
*PSC	334
*RCL	334
*RST.....	334
*SAV.....	335
*SRE.....	335
*STB?	335
*TRG	336
*TST?	336
*WAI	336

Other Commands

ABORt

Aborts a measurement in progress from a scan, returning the instrument to the trigger idle state.

- If a scan is in progress when the command is received, the scan will not be completed and you cannot resume the scan from where it left off. Note that if you initiate a new scan, all readings are cleared from reading memory.
-

FETCh?

Waits for measurements to complete and copies all available measurements to the instrument's output buffer. The readings remain in reading memory will not be erased when read with this command.

Example:

```
CONF:VOLT:DC 1,(@103, 105, 109)
TRIG:SOUR EXT
INIT
FETCh?
```

Returns: +4.98748741E-01,+4.35163427E-01,+4.33118686E-01

- The FETCh? query does not erase measurements from the reading memory. You can send the query multiple times to retrieve the same data.
 - You can save up to 100,000 readings in reading memory and all readings are automatically time stamped. If reading memory overflows, the new readings will overwrite the first (oldest) readings saved; the most recent readings are always preserved. No error is generated, but the Reading Memory Overflow bit (bit 12) is set in the Questionable Data Register's condition register.
 - Each time you start a new scan, the instrument clears all readings (including alarm data) saved in reading memory from the previous measurement. Therefore, the contents of reading memory are always from the most recent scan.
-

INITiate[:IMMediate]

Changes the state of the triggering system from "idle" to "wait-for-trigger", and clears the previous set of measurements from reading memory. Measurements will begin when the specified trigger conditions are satisfied following the receipt of INIT command.

Example:

```
CONF:VOLT:DC 10,(@101, 107)
TRIG:SOUR BUS
INIT
*TRG
FETC?
```

Returns: +4.98748741E-01,+4.35163427E-01

- Storing measurements in reading memory with INITiate is faster than sending measurements to the instrument's output buffer using READ? (provided you do not send FETCh? until done).
- The INITiate command is also an "overlapped" command. This means that after executing INITiate, you can send other commands that do not affect the measurements.
- To retrieve the measurements from the reading memory, use FETCh?. Use DATA:REMOve? or R? to read and erase all or part of the available measurements.
- Once you initiate a scan, an error will be generated if you attempt to change any measurement parameters (CONFigure and SENSE commands) or the triggering configuration (TRIGger commands).
- Use ABORt command to return to idle.

INSTrument:DMM

Enables (On) or disables (Off) the internal DMM.

Syntax: INSTrument:DMM {OFF|ON}

Query Syntax: INSTrument:DMM?

Parameter: 0 | 1 | OFF | ON

Return Parameter: 0 | 1, (0 = OFF, 1 = ON)

Example:

```
INST:DMM ON
```

- When you change the state of the internal DMM, the instrument issues a Factory Reset (*RST command).
-

R?

Reads and erases measurements from reading memory up to the specified <reading_number>.

The measurements are read and erased from the reading memory starting with the oldest measurement first.

Query Syntax: R? [<reading_number>]

Parameter: <reading_number> (1 ~ 100,000)

Example:

R? 4

Returns:

#263-1.12816521E-04,-1.13148354E-04,-1.13485152E-04,-1.13365632E-04

The "#2" means that the next 2 digits indicate how many characters are in the returned memory string.

In the above example, the 2 digits are the "63" after the "#2". Therefore, the remaining of the string is 63 digits long.

- If you do not specify a value for <reading_number>, all measurements are read and erased.

Example:

R?

Returns: #231-1.12816521E-04,-1.13148354E-04

- The R? and DATA:REMOve? queries can be used during a long series of readings to periodically remove readings from memory that would normally cause the reading memory to overflow. R? does not wait for all readings to complete. It sends the readings that are complete at the time the instrument receives the command.

- Use Read? or Fetch? if you want the instrument to wait until all readings are complete before sending readings.

- No error is generated if the reading memory contains less readings than requested. In this case, all available readings in memory are read and deleted.

READ?

Changes the state of the triggering system from "idle" to "wait-for-trigger". Scanning will begin when the specified trigger conditions are satisfied following the receipt of the READ? command. Readings are then sent to reading memory and the instrument's output buffer.

Example:

```
CONF:VOLT:DC 10,(@101,102)
TRIG:SOUR EXT
READ?
```

Returns: -1.13148354E-04,+3.15167734E-04

- The Read query will not return the unit or count number of the reading.
 - Sending READ? is similar to sending INITiate followed immediately by FETCh?
-

TIME:SYNC:SERVer

Sets or returns the server source for time sync.

Syntax: TIME:SYNC:SERVer "<server>"

Query Syntax: TIME:SYNC:SERVer?

Parameter: "<server>", max length = 24 characters

Return parameter: "<server>"

Example:

```
TIME:SYNC:SERV "time-nv.nist.gov"
```

UNIT:TEMPerature

Specifies the units °C (Celsius), °F (Fahrenheit), or K (Kelvin) to be used for all temperature measurements.

Syntax: UNIT:TEMPerature <unit>[,(@<ch_list>)]

Query Syntax: UNIT:TEMPerature? [(@<ch_list>)]

Parameter: <unit> (C | F | K)

Return parameter: C | F | K

Example:

```
CONF:TEMP TC,K,(@101,102)
```

```
UNIT:TEMP C,(@101,102)
```

- If the corresponding channels are not configured for temperature measurements prior to sending of this command, instrument will dispatch an error message.

- The CONFigure and MEASure? commands automatically select °C.

CALCulate Commands

CALCulate:AVERage:ALL?

Returns all of the statistic calculation values.

Query Syntax: CALCulate:AVERage:ALL? [(@<ch_list>)]

Return parameter: <NRf> (average, standard deviation, minimum, maximum, count)

Example:

```
CALC:AVER:ALL? (@101)
```

Returns:

```
-2.96976783E-03,+1.09347159E-04,-3.09208611E-03,-2.78148893E-03,+1.00000000E+01
```

CALCulate:AVERage:{AVERage|MAXimum|MINimum|PTPeak|SDEviation}?

Returns the average, maximum, minimum, peak-to-peak or standard deviation recorded values.

Query Syntax:

CALCulate:AVERage:{AVERage|MAXimum|MINimum|PTPeak|SDEviation}?
[(@<ch_list>)]

Return parameter: <NRf>

Example:

CALC:AVER:MAX? (@101,102,108)

Returns: +4.13148354E+00,+4.15167734E+00,+4.85178821E+00

- In this example, you can replace the MAX node with AVER, MIN, PTP or SDEV.

- If you omit the <ch_list> parameter, it returns the values for all channels in the currently defined scan list

CALCulate:AVERage:CLEar

Clears all of the statistic calculation values for the selected channels. The average, count, maximum, minimum, peak-to-peak and standard deviation values are cleared.

Syntax: CALCulate:AVERage:CLEar [(@<ch_list>)]

Parameter: [None]

Example:

CALC:AVER:CLE (@203:205)

CALCulate:AVERage:COUNT?

Returns the total number of recorded counts on each of the selected channels during the scan.

Query Syntax: CALCulate:AVERage:COUNT? [(@<ch_list>)]

Return parameter: <NRf>

Example:

CALC:AVER:COUN (@201:203)

Returns: +1.30000000E+01,+1.20000000E+01,+1.50000000E+01

- If you omit the <ch_list> parameter, it returns the count for all channels in the currently defined scan list.

CALCulate:AVERage:{MAXimum|MINimum}:TIME?

Returns the time that the maximum or minimum reading was taken on the selected channels during the scan (in full time and date format).

Query Syntax: CALCulate:AVERage:{MAXimum|MINimum}:TIME?
[(@<ch_list>)]

Return parameter: <time> (yyyy,mm,dd,hh,mm,ss.sss)

Example:

CALC:AVER:MIN:TIME? (@101,102)

Returns: 2023,03,01,07,26,20.146,2023,03,01,07,26,29.023

- In this example, you can replace the MIN node with MAX.
 - For each channel, the query returns the time in the form "yyyy,mm,dd,hh,mm,ss.sss".
-

CALCulate:LIMit:{LOWer|UPPer}

The instrument has four alarms which you can configure to alert you when a reading exceeds specified limits during a scan.

Syntax: CALCulate:LIMit:{LOWer|UPPer}
{<limit>|MIN|MAX|DEF},(@<ch_list>)]
Query Syntax: CALCulate:LIMit:{LOWer|UPPer}?
[{{(@<ch_list>)|MIN|MAX|DEF}]

Parameter: <limit> (-1.2E+09 ~ +1.2E+09); DEF: -1 (Lower), +1 (Upper)

Return parameter: <NRf>

Example:

CALC:LIM:LOW -3,(@101,102)

CALC:LIM:LOW? (@101,102)

Returns: -3.00000000E+00,-3.00000000E+00

- In this example, you can replace the LOW node with UPP.
 - The lower limit value must always be less than or equal to the upper limit.
-

CALCulate:LIMit:{LOWer|UPPer}:STATe

Enables or disables the lower and upper alarm limits on the specified channels during a scan.

Syntax: CALCulate:LIMit:{LOWer|UPPer}:STATe {OFF|ON}[,(@<ch_list>)]

Query Syntax: CALCulate:LIMit:{LOWer|UPPer}:STATe? [(@<ch_list>)]

Parameter: 0 | 1 | OFF | ON

Return parameter: 0 | 1, (0=OFF, 1=ON)

Example:

CALC:LIM:LOW 2(@101,102)

CALC:LIM:LOW:STAT ON,(@101,102)

CALC:LIM:LOW:STAT? (@101,102)

Returns: 1,1

- In this example, you can replace the LOW node with UPP.
-

CALCulate:MATH

A computed channel performs mathematical operation on the readings from measurement channels, or other computed channels list.

Syntax: CALCulate:MATH <expression>,(@<computed_ch_list>)

Query Syntax: CALCulate:MATH? (@<computed_ch_list>)

Parameter:

Computation type	Mathematical operation	<expression>
Basic math	Add	(@ch1+@ch2)
	Subtract	(@ch1-@ch2)
	Multiply	(@ch1*@ch2)
	Divide	(@ch1/@ch2)
	Power	(power(@ch1,2))
	Square root	(sqrt(@ch1))
	Reciprocal	(1/(@ch1))
Polynomial	Fifth order	(poly(@ch1, <n5>, <n4>, <n3>, <n2>, <n1>, <n0>)) where n = value of variable in each order
Statistics	Min	(min(@<ch_list>))
	Max	(max(@<ch_list>))
	Sum	(sum(@<ch_list>))
	Average	(avg(@<ch_list>))
	Standard deviation	(sdev(@<ch_list>))

Return parameter: "<string>"

Example:

CALC:MATH (@201-@202),(@402)

CALC:MATH? (@402)

Returns: " (@201-@202) "

CALC:MATH (sqrt(@201)),(@402)

CALC:MATH? (@402)

Returns: " (sqrt(@201)) "

CALC:MATH (poly(@201,3,2,1,1,1,0)),(@402)

CALC:MATH? (@402)

Returns:

"(poly(@201,+3.00000000E+00,+2.00000000E+00,+1.00000000E+00,+1.00000000E+00,+1.00000000E+00,+0.00000000E+00)) "

CALC:MATH (max(@201:203)),(@402)

CALC:MATH? (@402)

Returns: " (max(@201,202,203)) "

● Only supported on computed channels (channels 401 through 420).

CALCulate:SCALE:DB:REFerence

Sets or returns reference value for the dB function.

Syntax: CALCulate:SCALE:DB:REFerence

{<reference>|MIN|MAX|DEF}[,(@<ch_list>)]

Query Syntax: CALCulate:SCALE:DB:REFerence?

[{(@<ch_list>)|MIN|MAX|DEF}]

Parameter: <reference> (-2.0E+02 ~ +2.0E+02); DEF: 0

Return parameter: <NRf>

Example:

CALC:SCAL:DB:REF 100

CALC:SCAL:DB:REF?

Returns: +1.00000000E+02

CALCulate:SCALE:DBM:REFerence

Sets or returns resistance value for the dBm function.

Syntax: CALCulate:SCALE:DBM:REFerence

{<reference>|MIN|MAX|DEF}[,(@<ch_list>)]

Query Syntax: CALCulate:SCALE:DBM:REFerence?

[{(@<ch_list>)|MIN|MAX|DEF}]

Parameter: <reference> (2, 4, 8, 16, 50, 75, 93, 110, 124, 125, 135, 150, 250, 300, 500, 600, 800, 900, 1000, 1200, 8000); DEF: 600

Return parameter: <NRf>

Example:

CALC:SCAL:DBM:REF DEF

CALC:SCAL:DBM:REF?

Returns: +6.00000000E+02

CALCulate:SCALE:DECimal:POINT

Under the Math function, the display of measured values vary in accordance with either the fixed range setting (Range) or auto range setting (Auto).

Syntax: CALCulate:SCALE:DECimal:POINT <type>[,(@<ch_list>)]

Query Syntax: CALCulate:SCALE:DECimal:POINT? [(@<ch_list>)]

Parameter: <type> (AUTO | RANGe)

Return parameter: AUTO | RANG

Example:

CALC:SCAL:DEC:POIN RANG

CALC:SCAL:DEC:POIN?

Returns: RANG

CALCulate:SCALE:FUNCtion

Sets or returns the advanced function.

Syntax: CALCulate:SCALE:FUNCtion <function>[,@<ch_list>]

Query Syntax: CALCulate:SCALE:FUNCtion? [@<ch_list>]

Parameter: <function> (OFF | DB | DBM | SCALE | INV | PCT)

Return parameter: OFF | DB | DBM | SCAL | INV | PCT

Example:

```
CALC:SCAL:FUNC DB
```

•dB scaling function is only available when the measurement function on the specified channels sets to DCV orACV.

CALCulate:SCALE:GAIN

Sets or returns the scale factor M for math measurement.

Syntax: CALCulate:SCALE:GAIN {<gain>|MIN|MAX|DEF}[,(@<ch_list>)]

Query Syntax: CALCulate:SCALE:GAIN? [(@<ch_list>)|MIN|MAX|DEF]

Parameter: <gain> (-1.2E+09 ~ +1.2E+09); DEF: 1

Return parameter: <NRf>

Example:

```
CALC:SCAL:FUNC SCAL
```

```
CALC:SCAL:GAIN 0.5
```

```
CALC:SCAL:GAIN?
```

```
Returns: +0.50000000E+00
```

CALCulate:SCALE:OFFSet

Sets or returns the offset factor B for math measurement.

Syntax: CALCulate:SCALE:OFFSet {<offset>|MIN|MAX|DEF}[,(@<ch_list>)]

Query Syntax: CALCulate:SCALE:OFFSet? [(@<ch_list>)|MIN|MAX|DEF]

Parameter: <offset> (-1.2E+09 ~ +1.2E+09); DEF: 0

Return parameter: <NRf>

Example:

```
CALC:SCAL:FUNC SCAL
```

```
CALC:SCAL:OFFS 0.01
```

```
CALC:SCAL:OFFS?
```

```
Returns: +1.00000000E-02
```

CALCulate:SCALE:OFFSet:NULL

Makes an immediate null measurement on the specified channels and stores it as the offset (B) for subsequent measurements.

Syntax: CALCulate:SCALE:OFFSet:NULL [(@<ch_list>)]

Parameter: [None]

Example:

```
CALC:SCAL:FUNC SCAL
CALC:SCAL:OFFS:NULL (@101)
```

CALCulate:SCALE:PERCent

Sets or returns the reference value for the PCT function.

Syntax: CALCulate:SCALE:PERCent

{<reference>|MIN|MAX|DEF}[,@<ch_list>]

Query Syntax: CALCulate:SCALE:PERCent? [(@<ch_list>)|MIN|MAX|DEF]

Parameter: <reference> (-1.2E+09 ~ +1.2E+09); DEF: 1

Return parameter: <NRf>

Example:

```
CALC:SCAL:FUNC PCT
CALC:SCAL:REF 0.1
CALC:SCAL:REF?
Returns: +1.0000000E-01
```

CALCulate:SCALE:REFeRence

Sets or returns the reference value for the PCT function.

Syntax: CALCulate:SCALE:REFeRence

{<reference>|MIN|MAX|DEF}[,@<ch_list>]

Query Syntax: CALCulate:SCALE:REFeRence?

[(@<ch_list>)|MIN|MAX|DEF]

Parameter: <reference> (-1.2E+09 ~ +1.2E+09); DEF: 1

Return parameter: <NRf>

Example:

```
CALC:SCAL:FUNC PCT
CALC:SCAL:REF 0.1
CALC:SCAL:REF?
Returns: +1.0000000E-01
```

CALCulate:SCALE:REFerence:AUTO

Enables or disables automatic reference selection for the scaling functions.

Syntax: CALCulate:SCALE:REFerence:AUTO {OFF|ON}[,@<ch_list>]

Query Syntax: CALCulate:SCALE:REFerence:AUTO? [(@<ch_list>)]

Parameter: 0 | 1 | OFF | ON

Return parameter: 0 | 1, (0 = OFF, 1 = ON)

ON: the first measurement made is used as the reference for all subsequent measurements, and automatic reference selection is disabled.

OFF:

CALCulate:SCALE:DB:REFerence specifies the reference for DB scaling,
CALCulate:SCALE:REFerence specifies the reference for PCT scaling.

Example:

CALC:SCAL:REF:AUTO ON

CALCulate:SCALE:REFerence:IMMEDIATE

Makes an immediate reference measurement on PCT (%) and dB scaling functions and save the reference value for subsequent measurements.

Syntax: CALCulate:SCALE:REFerence:IMMEDIATE [(@<ch_list>)]

Parameter: [None]

Example:

CALC:SCAL:REF:IMM

- This command performs the reference measurement on both PCT and dB scaling functions simultaneously.

CALCulate:SCALE[:STATe]

Enables or disables the scaling function.

Syntax: CALCulate:SCALE[:STATe] {OFF|ON}[,@<ch_list>]

Query Syntax: CALCulate:SCALE[:STATe]? [(@<ch_list>)]

Parameter: 0 | 1 | OFF | ON

Return parameter: 0 | 1, (0 = OFF, 1 = ON)

Example:

CALC:SCAL:STAT ON

CALCulate:SCALE:UNIT

To specify the custom unit up to three characters (for example: RPM, PSI, or °C) for scaled measurements.

Syntax: CALCulate:SCALE:UNIT "<string>"[,(@<ch_list>)]

Query Syntax: CALCulate:SCALE:UNIT? [(@<ch_list>)]

Parameter: "<string>", max length = 3 characters

Return parameter: "<string>"

Example:

```
CALC:SCAL:UNIT "BAR"
```

```
CALC:SCAL:UNIT?
```

Returns: "BAR"

CALCulate:SCALE:UNIT:STATE

Enables or disables displaying the unit string with measurements on the front panel when the scaling function is enabled.

Syntax: CALCulate:SCALE:UNIT:STATE {OFF|ON}[,(@<ch_list>)]

Query Syntax: CALCulate:SCALE:UNIT:STATE? [(@<ch_list>)]

Parameter: 0 | 1 | OFF | ON

Return parameter: 0 | 1, (0 = OFF, 1 = ON)

Example:

```
CALC:SCAL:UNIT "PSI"
```

```
CALC:SCAL:UNIT:STAT ON
```

CONFigure Commands

CONFigure?

Returns the present configurations (function, range, and resolution) on the specified channels with a series of quoted strings.

Query Syntax: CONFigure? [(@<ch_list>)]

Parameter: [None]

Return parameter: "<present configurations>"

Example:

```
CONF:VOLT:DC 10,MIN,(@101)
```

```
CONF?
```

Returns: "VOLT +1.00000000E+01,+1.00000000E-05"

CONFigure:CAPacitance

Configures the channels for Capacitance measurements.

Syntax: CONFigure:CAPacitance

[{<range>|AUTO|MIN|MAX|DEF},{<resolution>|MIN|MAX|DEF},](@<ch_list>)

Parameter: <range> (1nF | 10nF | 100nF | 1μF | 10μF | 100μF); DEF: AUTO

Example:

CONF:CAP 10e-7,(@101)

CONFigure:CURRent:{AC|DC}

Configures the channels for AC and DC current measurements.

Syntax: CONFigure:CURRent:{AC|DC}

[{<range>|AUTO|MIN|MAX|DEF},{<resolution>|MIN|MAX|DEF},](@<ch_list>)

Parameter:

<range>:

AC: (100μA | 1mA | 10mA | 100mA | 2A); DEF: AUTO

DC: (1μA | 10μA | 100μA | 1mA | 10mA | 100mA | 2A); DEF: AUTO

Example:

CONF:CURR:AC 10e-2,(@121)

CONF:CURR:DC 10e-3,DEF,(@122)

●Autoranging (AUTO or DEFault), will generate an error if you specify a <resolution> because the instrument cannot accurately resolve the integration time (especially if the input continuously changes). If your application requires autoranging, specify DEFault for the <resolution> or omit the <resolution> altogether.

CONFigure:DIODE

Configures the channels for Diode measurements.

Syntax: CONFigure:DIODE (@<ch_list>)

Example:

CONF:DIOD (@101)

CONFigure: {FREQuency|PERiod}

Configures the channels for frequency and period measurements

Syntax: CONFigure: {FREQuency|PERiod}

[{<range>|AUTO|MIN|MAX|DEF}, [{<resolution>|MIN|MAX|DEF}],] (@<ch_list>)

Parameter:

<range>:

Frequency: 3Hz ~ 300kHz; DEF: 20Hz

Period: 3.33 μ s ~ 333.33ms; DEF: 50ms

Example:

```
CONF:FREQ MAX, (@101)
```

```
CONF:PER AUTO, DEF, (@101)
```

CONFigure: {RESistance|FRESistance}

Configures the channels for 2-Wire and 4-Wire resistance measurements.

Syntax: CONFigure: {RESistance|FRESistance}

[{<range>|AUTO|MIN|MAX|DEF}, [{<resolution>|MIN|MAX|DEF}],] (@<ch_list>)

Parameter:

<range> (100 Ω | 1k Ω | 10k Ω | 100k Ω | 1M Ω | 10M Ω | 100M Ω | 1G Ω); DEF: 1k Ω

Example:

```
CONF:RES 1e2, (@101)
```

```
CONF:FRES 1e3, MAX, (@101)
```

- Autoranging (AUTO or DEFault), will generate an error if you specify a <resolution> because the instrument cannot accurately resolve the integration time (especially if the input continuously changes). If your application requires autoranging, specify DEFault for the <resolution> or omit the <resolution> altogether.
-

CONFigure:STRain:{DIrect|FDIrect}

Configures the channels for direct 2-Wire and 4-Wire strain gage measurements.

Syntax: CONFigure:STRain:{DIrect|FDIrect}
 [{<gage_ohms>|MIN|MAX|DEF},{<gage_factor>|MIN|MAX|DEF},
 [{<range>|MIN|MAX|DEF},{<resolution>|MIN|MAX|DEF},]]](@<ch_list>)

Parameter:

<gage_ohms> (80 ~ 1100 Ω); DEF: 120 Ω

<gage_factor> (0.5 ~ 5); DEF: 2

<range> (100 Ω | 1k Ω | 10k Ω | 100k Ω | 1M Ω | 10M Ω | 100M Ω | 1G Ω); DEF: 1k Ω

Example:

CONF:STR:DIR 100,1,(@101)

CONFigure:STRain:{FULL|HALF}:BENDing

Configures the channels for full and half bending bridge strain gage measurements.

Syntax: CONFigure:STRain:{FULL|HALF}:BENDing
 [{<gage_factor>|MIN|MAX|DEF},{<range>|MIN|MAX|DEF},{<resolution>|
 MIN|MAX|DEF},]]](@<ch_list>)

Parameter:

<gage_factor> (0.5 ~ 5); DEF: 2

<range> (100mV | 1V | 10V | 100V | 600V); DEF: AUTO

Example:

CONF:STR:FULL:BEND 1,0.1,(@101)

CONFigure:STRain:{FULL|HALF}:POISSon

Configures the channels for full and half poisson bridge strain gage measurements.

Syntax: CONFigure:STRain:{FULL|HALF}:POISSon
 [{<gage_factor>|MIN|MAX|DEF},{<poisson_ratio>|MIN|MAX|DEF},{<range>|
 MIN|MAX|DEF},{<resolution>|MIN|MAX|DEF},]]](@<ch_list>)

Parameter:

<gage_factor> (0.5 ~ 5); DEF: 2

<poisson_ratio> (-0.9999 ~ 0.5); DEF: 0.3

<range> (100mV | 1V | 10V | 100V | 600V); DEF: AUTO

Example:

CONF:STR:FULL:POIS (@101)

CONFigure:STRain:FULL:BENding:POISson

Configures the channels for full bending poisson bridge strain gage measurements.

Syntax: CONFigure:STRain:{FULL|HALF}:POISson
 [{<gage_factor>|MIN|MAX|DEF},{<poisson_ratio>|MIN|MAX|DEF},{<range>|MIN|MAX|DEF},{<resolution>|MIN|MAX|DEF},]](@<ch_list>)

Parameter:

<gage_factor> (0.5 ~ 5); DEF: 2

<poisson_ratio> (-0.9999 ~ 0.5); DEF: 0.3

<range> (100mV | 1V | 10V | 100V | 600V); DEF: AUTO

Example:

CONF:STR:FULL:BEND:POIS 0.5,0.1,(@101)

CONFigure:STRain:QUARter

Configures the channels for quarter bridge strain gage measurements.

Syntax: CONFigure:STRain:QUARter
 {<gage_factor>|MIN|MAX|DEF},{<range>|MIN|MAX|DEF},{<resolution>|MIN|MAX|DEF},]](@<ch_list>)

Parameter:

<gage_factor> (0.5 ~ 5); DEF: 2

<range> (100mV | 1V | 10V | 100V | 600V); DEF: AUTO

Example:

CONF:STR:QUAR 1,(@101)

CONFigure:TEMPerature

Configures the channels for temperature measurements.

Syntax: CONFigure:TEMPerature
 <probe_type>,{<type>|DEF},{<resolution>|MIN|MAX|DEF},]](@<ch_list>)

Parameter:

<probe type> (TCouple | RTD | FRTD | THERmistor | FTHERmistor)

<type>:

TCouple: (B | E | J | K | N | R | S | T | USER) ; DEF: J

RTD / FRTD : (PT100 | D100 | F100 | PT385 | PT3916 | USER) ; DEF: PT100

THERmistor / FTHERmistor : (2.2kΩ | 5kΩ | 10kΩ | USER); DEF: 5kΩ

Example:

CONF:TEMP TC,K,(@101)

CONFigure[:VOLTage]:{AC|DC}

Configures the channels for AC and DC voltage measurements

Syntax: CONFigure[:VOLTage]:{AC|DC}

[{<range>|AUTO|MIN|MAX|DEF},{<resolution>|MIN|MAX|DEF},](@<ch_list>)

Parameter:

<range>:

AC: (100mV | 1V | 10V | 100V | 400V); DEF:AUTO

DC: (100mV | 1V | 10V | 100V | 600V); DEF:AUTO

Example:

CONF:VOLT:AC 10e-2,(@201)

CONF:VOLT:DC 1,MAX,(@101)

- Autoranging (AUTO or DEFault), will generate an error if you specify a <resolution> because the instrument cannot accurately resolve the integration time (especially if the input continuously changes). If your application requires autoranging, specify DEFault for the <resolution> or omit the <resolution> altogether.

DATA Commands

DATA:LAST?

Returns the most recent reading or readings taken on the selected channel during the scan.

Query Syntax: DATA:LAST? [<num_rdgs>,@<ch_list>]

Parameter: <num_rdgs> (1 ~ 1000)

Return parameter: <NRf>

Example:

DATA:LAST? 1,(@101)

Returns: +0.15900000E+01

- If no data is available for the specified channel, an error will be generated.

DATA:POINts?

Returns the total number of readings currently saved in reading memory from a scan.

Return parameter: <NR1>

Example:

DATA:POIN?

Returns: +10

- You can store up to 100,000 measurements in the reading memory.
-

DATA:POINts:EVENT:THReshold

Sets or returns the threshold for event number of measurement.

Syntax: DATA:POINts:EVENT:THReshold <num_rdgs>

Query Syntax: DATA:POINts:EVENT:THReshold?

Parameter: <num_rdgs> (1 ~ 100,000)

Return parameter: <NR1>

Example:

DATA:POIN:EVENT:THR 20

DATA:POIN:EVENT:THR?

Returns: +20

- When measurement numbers reach the set threshold, the Bit9 within the Operater Event Register (STATus:OPERation:EVENT) will be set as 1.
 - Once the Memory Threshold bit (bit 9 in the Standard Operation Event register) is set, it remains set until cleared by STATus:OPERation:EVENT? or *CLS.
-

DATA:REMove?

Reads and erases measurements from reading memory up to the specified <num_rdgs>. The measurements are read and erased from the reading memory starting with the oldest measurement first.

Query Syntax: DATA:REMove? <num_rdgs>,[WAIT]

Parameter: <num_rdgs> (1 ~ 100,000)

Example:

DATA:REM? 4

Returns:

-1.12816521E-04,-1.13148354E-04,-1.13485152E-04,-1.13365632E-04

- You can use the DATA:POINts? query to determine the total number of readings currently in reading memory.
 - If <num_rdgs> is greater than the latest counts of measurement, it will return the error. However, it will return data if <num_rdgs> of counts of measurement reach the set threshold only when WAIT parameter is specified.
 - The R? and DATA:REMove? queries can be used during a long series of readings to periodically remove readings from memory that would normally cause the reading memory to overflow. R? does not wait for all readings to complete. It sends the readings that are complete at the time the instrument receives the command.
 - If reading memory overflows, the new readings will overwrite the first (oldest) readings saved; the most recent readings are always preserved. No error is generated, but the Reading Memory Overflow bit (bit 12) is set in the Questionable Data Register's condition register.
-

DIGital INTerface Commands

DIGital:INTerface:MODE

Sets or returns the application mode of digital I/O (Remote Control Only).
For details, refer to page 139.

Syntax: DIGital:INTerface:MODE <type>
Query Syntax: DIGital:INTerface:MODE?

Parameter: <type> (COPM | 4094 | IO)
Return parameter: COPM | 4094 | IO

Example:
DIG:INT:MODE IO

DIGital:INTerface:DATA:OUTPut

When the 4094 mode (serial to parallel) is selected for digital I/O, make use of this command to set output status.

Syntax: DIGital:INTerface:DATA:OUTPut <data>,<strobe_pulse>

Parameter: <data> (0 ~ 255); <strobe_pulse> (0 | 1)

Example:
DIG:INT:MODE 4094
DIG:INT:DATA:OUPT 10,1

DIGital:INTerface:DATA:SETup

When the IO mode is selected for digital I/O, make use of this command to set output status.

Syntax: DIGital:INTerface:DATA:SETup <boolean>

Parameter: <boolean> (0 | 1), (DIO1, DIO2, DIO3, DIO4)

Example:
DIG:INT:MODE IO
DIG:INT:DATA:SET 0,1,0,1
Sets DIO1 to low, DIO2 to high, DIO3 to low, DIO4 to high.

DISPlay Commands

DISPlay

Enables (On) or disables (Off) front panel display. When disabled, the entire front panel display turns black and time stamp is displayed.

Syntax: DISPlay {OFF|ON}

Query Syntax: DISPlay?

Parameter: 0 | 1 | OFF | ON

Return parameter: 0 | 1, (0 = OFF, 1 = ON)

Example:

DISP ON

- All keys except "Local" are disabled when the display is OFF.
 - To enable the display, send DISPlay ON or press the front panel Shift key (Local).
-

DISPlay:TEXT

Displays a text on the instrument's front panel display.

Syntax: DISPlay:TEXT "<message>"

Query Syntax: DISPlay:TEXT?

Parameter: "<message>", max length = 40 characters

Return parameter: "<message>"

Example:

DISP:TEXT "testing"

- Sending a text message to the display overrides the display state; this means that you can display a message even if the display is turned off.
-

DISPlay:TEXT:CLEAr

Clears the text message from the display.

- With DISP ON, DISP:TEXT:CLE returns the display to its normal mode.
 - With DISP OFF, DISP:TEXT:CLE clears the message and the display remains disabled.
-

FORMat Commands

FORMat:READing:ALARm

Enables (On) or disables (Off) the inclusion of alarm information in the reading format.

Syntax: FORMat:READing:ALARm {OFF|ON}

Query Syntax: FORMat:READing:ALARm?

Parameter: 0 | 1 | OFF | ON

Return parameter: 0 | 1, (0 = OFF, 1 = ON)

Example:

```
FORM:READ:ALAR ON
```

FORMat:READing:CHANnel

Enables (On) or disables (Off) the inclusion of channel number information in the reading format.

Syntax: FORMat:READing:CHANnel {OFF|ON}

Query Syntax: FORMat:READing:CHANnel?

Parameter: 0 | 1 | OFF | ON

Return parameter: 0 | 1, (0 = OFF, 1 = ON)

Example:

```
FORM:READ:CHAN ON
```

FORMat:READing:TIME

Enables (On) or disables (Off) the inclusion of time stamp information in the reading format.

Syntax: FORMat:READing:TIME {OFF|ON}

Query Syntax: FORMat:READing:TIME?

Parameter: 0 | 1 | OFF | ON

Return parameter: 0 | 1, (0 = OFF, 1 = ON)

Example:

```
FORM:READ:TIME ON
```

FORMat:READing:TIME:TYPE

Selects the time format (absolute or relative) for time stamp returned when FORMat:READing:TIME is enabled.

Syntax: FORMat:READing:TIME:TYPE {ABSolute|RELative}

Query Syntax: FORMat:READing:TIME:TYPE?

Parameter: ABSolute | RELative

Return parameter: ABS | REL

Example:

FORM:READ:TIME:TYPE ABS

- Relative format - shows the time since the start of the scan.

Ex:+1.12379111E-03 VDC,00000000.659,101,2

1 2 3 4

1. Reading with units (1.124mV)
2. Elapsed time (659ms)
3. Channel number
4. Alarm limit threshold crossed (0 = No alarm, 1 = LO, 2 = HI)

- Absolute format - shows the time of the day with the date.

Ex:+1.12379111E-03 VDC,2021,01,28,00,43,39.218,101,0

1 2 3 4 5

1. Reading with units (1.124mV)
2. Date (January 28, 2021)
3. Time of day (0:43:39.218 AM)
4. Channel number
5. Alarm limit threshold crossed (0 = No alarm, 1 = LO, 2 = HI)

FORMat:READing:UNIT

Enables (On) or disables (Off) the inclusion of measurement units (VAC, VDC, OHM, etc.) in the reading format.

Syntax: FORMat:READing:UNIT {OFF|ON}

Query Syntax: FORMat:READing:UNIT?

Parameter: 0 | 1 | OFF | ON

Return parameter: 0 | 1, (0 = OFF, 1 = ON)

Example:

FORM:READ:UNIT ON

HCOPY Commands

HCOPY:SDUMp:DATA?

Executes TFT LCD screenshot action.

Returns the front panel display image ("screen shot").

Returns a count of data streaming by the image file format of BMP.

MEASure Commands

MEASure:CAPacitance?

Configures the channels for capacitance measurements and immediately sweeps through the specified channels one time (independent of the present scan list). The results are sent directly to reading memory and the instrument's output buffer.

Query Syntax: MEASure:CAPacitance?

[{<range>|AUTO|MIN|MAX|DEF},{<resolution>|MIN|MAX|DEF},,](@<ch_list>)

Parameter: <range> (1nF | 10nF | 100nF | 1μF | 10μF | 100μF); DEF: AUTO

Example:

MEAS:CAP? DEF,(@101)

Returns: +3.72695852E-11

MEASure:CURRent:{AC|DC}?

Configures the channels for AC and DC current measurements and immediately sweeps through the specified channels one time (independent of the present scan list). The results are sent directly to reading memory and the instrument's output buffer.

Query Syntax: MEASure:CURRent:{AC|DC}?

[{<range>|AUTO|MIN|MAX|DEF},{<resolution>|MIN|MAX|DEF},,](@<ch_list>)

Parameter:

<range>:

AC: (100μA | 1mA | 10mA | 100mA | 2A); DEF: AUTO

DC: (1μA | 10μA | 100μA | 1mA | 10mA | 100mA | 2A); DEF: AUTO

Return parameter: <NRf>

Example:

MEAS:CURR:AC? 10e-2,(@121,122)

Returns: +0.32921419E-01,+0.15224990E-01

- Autoranging (AUTO or DEFault), will generate an error if you specify a <resolution> because the instrument cannot accurately resolve the integration time (especially if the input continuously changes). If your application requires autoranging, specify DEFault for the <resolution> or omit the <resolution> altogether.

MEASure:DIODE?

Configures the channels for Diode current measurements and immediately sweeps through the specified channels one time (independent of the present scan list). The results are sent directly to reading memory and the instrument's output buffer.

Query Syntax: MEASure:DIODE? (@<ch_list>)

Parameter: [None]

Return parameter: <NRf>

Example:

MEAS:DIOD? (@101)

Returns: +0.69324990E+00

- The range and resolution for diode test are fixed at 1 VDC, with a 1 mA current source output.
-

MEASure:{FREQuency|PERiod}?

Configures the channels for frequency and period measurements and immediately sweeps through the specified channels one time (independent of the present scan list). The results are sent directly to reading memory and the instrument's output buffer.

Query Syntax: MEASure:{FREQuency|PERiod}?

[{<range>|AUTO|MIN|MAX|DEF},{<resolution>|MIN|MAX|DEF},,](@<ch_list>)

Parameter:

<range>:

AC: 3Hz to 300kHz; DEF: 20Hz

DC: 3.33 μ s to 333.33ms; DEF: 50ms

Return parameter: <NRf>

Example:

MEAS:FREQ? MIN,(@101)

Returns: +5.98876820E+01

MEASure:{RESistance|FRESistance}?

Configures the channels for 2-Wire and 4-Wire resistance measurements and immediately sweeps through the specified channels one time (independent of the present scan list). The results are sent directly to reading memory and the instrument's output buffer.

Query Syntax: MEASure:{RESistance|FRESistance}?

[{<range>|AUTO|MIN|MAX|DEF},{<resolution>|MIN|MAX|DEF},,](@<ch_list>)

Parameter:

<range> (100Ω | 1kΩ | 10kΩ | 100kΩ | 1MΩ | 10MΩ | 100MΩ | 1GΩ); DEF: AUTO

Return parameter: <NRf>

Example:

MEAS:RES? 100,(@101)

Returns: +3.98776210E+01

- Autoranging (AUTO or DEFault), will generate an error if you specify a <resolution> because the instrument cannot accurately resolve the integration time (especially if the input continuously changes). If your application requires autoranging, specify DEFault for the <resolution> or omit the <resolution> altogether.

MEASure:STRain:{DIRect|FDIRect}?

Configures the channels for direct 2-Wire and 4-Wire strain gage measurements and immediately sweeps through the specified channels one time (independent of the present scan list). The results are sent directly to reading memory and the instrument's output buffer.

Query Syntax: MEASure:STRain:{DIRect|FDIRect}?

[{<gage_ohms>|MIN|MAX|DEF},{<gage_factor>|MIN|MAX|DEF},[{<range>|MIN|MAX|DEF},{<resolution>|MIN|MAX|DEF},,]](@<ch_list>)

Parameter:

<gage_ohms> (80 ~ 1100Ω); DEF: 120Ω

<gage_factor> (0.5 ~ 5); DEF: 2

<range> (100Ω | 1kΩ | 10kΩ | 100kΩ | 1MΩ | 10MΩ | 100MΩ | 1GΩ); DEF: 1kΩ

Return parameter: <NRf>

Example:

MEAS:STR:DIR? 100,1,(@101)

Returns: +7.08176210E+01

MEASure:STRain:{FULL|HALF}:BENDing?

Configures the channels for full and half bending bridge strain gage measurements and immediately sweeps through the specified channels one time (independent of the present scan list). The results are sent directly to reading memory and the instrument's output buffer.

Query Syntax: MEASure:STRain:{FULL|HALF}:BENDing?

[{<gage_factor>|MIN|MAX|DEF},{<range>|MIN|MAX|DEF},{<resolution>|MIN|MAX|DEF},]](@<ch_list>)

Parameter:

<gage_factor> (0.5 ~ 5); DEF: 2

<range> (100mV | 1V | 10V | 100V | 600V); DEF: AUTO

Return parameter: <NRf>

Example:

MEAS:STR:FULL:BEND? 1,0.1,(@101)

Returns: +7.08176210E-01

MEASure:STRain:{FULL|HALF}:POISson?

Configures the channels for full and half poisson bridge strain gage measurements and immediately sweeps through the specified channels one time (independent of the present scan list). The results are sent directly to reading memory and the instrument's output buffer.

Query Syntax: MEASure:STRain:{FULL|HALF}:POISson?

[{<gage_factor>|MIN|MAX|DEF},{<poisson_ratio>|MIN|MAX|DEF},{<range>|MIN|MAX|DEF},{<resolution>|MIN|MAX|DEF},]](@<ch_list>)

Parameter:

<gage_factor> (0.5 ~ 5); DEF: 2

<poisson_ratio> (-0.9999 ~ 0.5); DEF: 0.3

<range> (100mV | 1V | 10V | 100V | 600V); DEF: AUTO

Return parameter: <NRf>

Example:

MEAS:STR:FULL:POIS? (@101)

Returns: +1.08176210E+00

MEASure:STRain:FULL:BENDing:POISson?

Configures the channels for full bending poisson bridge strain gage measurements and immediately sweeps through the specified channels one time (independent of the present scan list). The results are sent directly to reading memory and the instrument's output buffer.

Query Syntax: MEASure:STRain:FULL:BENDing:POISson?

[{<gage_factor>|MIN|MAX|DEF},{<poisson_ratio>|MIN|MAX|DEF},{<range>|MIN|MAX|DEF},{<resolution>|MIN|MAX|DEF},]](@<ch_list>)

Parameter:

<gage_factor> (0.5 ~ 5); DEF: 2

<poisson_ratio> (-0.9999 ~ 0.5); DEF: 0.3

<range> (100mV | 1V | 10V | 100V | 600V); DEF: AUTO

Return parameter: <NRf>

Example:

MEAS:STR:FULL:BEND:POIS? 0.5,0.1,(@101)

Returns: +0.68176210E-01

MEASure:STRain:QUARter?

Configures the channels for quarter bridge strain gage measurements and immediately sweeps through the specified channels one time (independent of the present scan list). The results are sent directly to reading memory and the instrument's output buffer.

Query Syntax: MEASure:STRain:QUARter?

{<gage_factor>|MIN|MAX|DEF},{<range>|MIN|MAX|DEF},{<resolution>|MIN|MAX|DEF},]](@<ch_list>)

Parameter:

<gage_factor> (0.5 ~ 5); DEF: 2

<range> (100mV | 1V | 10V | 100V | 600V); DEF: AUTO

Return parameter: <NRf>

Example:

MEAS:STR:QUAR? 1,(@101)

Returns: +0.28176210E+00

MEASure:TEMPerature?

Configures the channels for temperature measurements and immediately sweeps through the specified channels one time (independent of the present scan list). The results are sent directly to reading memory and the instrument's output buffer.

Query Syntax: MEASure:TEMPerature?

<probe_type>,[{<type>|DEF},{<resolution>|MIN|MAX|DEF},,](@<ch_list>)

Parameter:

<probe type> (TCouple | FRTD | RTD | FTHermistor | THERmistor)

<type>:

TCouple: (B | E | J | K | N | R | S | T | USER) ; DEF: J

RTD / FRTD : (PT100 | D100 | F100 | PT385 | PT3916 | USER) ; DEF: PT100

THERmistor / FTHermistor : (2.2k Ω | 5k Ω | 10k Ω | USER); DEF: 5k Ω

Example:

MEAS:TEMP? TC,K,(@101)

Returns: +2.51176210E+01

MEASure[:VOLTage]:{AC|DC}?

Configures the channels for AC and DC voltage measurements.

Query Syntax: MEASure[:VOLTage]:{AC|DC}?

[{<range>|AUTO|MIN|MAX|DEF},{<resolution>|MIN|MAX|DEF},,](@<ch_list>)

Parameter:

<range>:

AC: (100mV | 1V | 10V | 100V | 400V); DEF:AUTO

DC: (100mV | 1V | 10V | 100V | 600V); DEF:AUTO

Example:

MEAS:VOLT:AC? 100,(@101)

Returns: +3.71176210E+01

- Autoranging (AUTO or DEFault), will generate an error if you specify a <resolution> because the instrument cannot accurately resolve the integration time (especially if the input continuously changes). If your application requires autoranging, specify DEFault for the <resolution> or omit the <resolution> altogether.

MMEMory Commands

MMEMory:FORMat:READing:CHEAder

Specifies the content of each column header to be either the channel number (NUMber) or the channel's user-defined label (LABel).

Syntax: MMEMory:FORMat:READing:CHEAder {NUMber|LABel}

Query Syntax: MMEMory:FORMat:READing:CHEAder?

Parameter: NUMber | LABel

Return parameter: NUM | LAB

Example:

```
MMEM:FORM:READ:CHEA LAB
```

- If the value of the column header is set to LABel using the ROUTe:CHANnel:LABel command, any channel without a user-defined label will display its factory-default channel label instead on its column header.

MMEMory:FORMat:READing:CSEParator

Specifies the character to use for separating the information on each row.

Syntax: MMEMory:FORMat:READing:CSEParator

{COMMa|SEMicolon|TAB}

Query Syntax: MMEMory:FORMat:READing:CSEParator?

Parameter: COMMa | SEMicolon | TAB

Return parameter: COMM | SEM | TAB

Example:

```
MMEM:FORM:READ:CSEP COMM
```

MMEMory:FORMat:READing:RLIMit

Specifies the row limit (maximum number of rows for sweep data) that will be written to each data logging file by the count set by MMEMory:FORMat:READing:RLIMit:COUNT command.

Syntax: MMEMory:FORMat:READing:RLIMit {OFF|ON}

Query Syntax: MMEMory:FORMat:READing:RLIMit?

Parameter: 0 | 1 | OFF | ON

Return parameter: 0 | 1, (0 = OFF, 1 = ON)

Example:

```
MMEM:FORM:READ:RLIM ON
```

MMEMory:FORMat:READing:RLIMit:COUNT

Sets the row limits count when MMEMory:FORMat:READing:RLIMit ON is set.

Syntax: MMEMory:FORMat:READing:RLIMit:COUNT

{<number>|MIN|MAX|DEF}

Query Syntax: MMEMory:FORMat:READing:RLIMit:COUNT?

[{MIN|MAX|DEF}]

Parameter: <number> (65536 | 1048576); DEF: 65536

Return parameter: <NR1>

Example:

MMEM:FORM:READ:RLIM:COUN 10000

MMEMory:LOG[:ENABLE]

Enables (On) or disables (Off) logging of the scanned memory readings to a USB drive connected to the front panel USB host port.

Syntax: MMEMory:LOG[:ENABLE] {OFF|ON}

Query Syntax: MMEMory:LOG[:ENABLE]?

Parameter: 0 | 1 | OFF | ON

Return parameter: 0 | 1, (0 = OFF, 1 = ON)

Example:

MMEM:LOG ON

Output Commands

OUTPut:ALARm:CLEar:ALL

Clears the state of all four alarm output lines.

Parameter: [None]

Example:

```
OUTP:ALAR:CLE
```

- You can manually clear the output lines at any time (even during a scan) and the alarm data in reading memory is not cleared. However, data is cleared when you initiate a new scan.

OUTPut:ALARm{1|2|3|4}:CLEar

Clears the state of specified alarm output lines.

Parameter: [None]

Example:

```
OUTP:ALAR3:CLE
```

- You can manually clear the output lines at any time (even during a scan) and the alarm data in reading memory is not cleared. However, data is cleared when you initiate a new scan.

OUTPut:ALARm{1|2|3|4}:SOURce

Assigns one of four alarm numbers to report any alarm conditions on the specified multiplexer or digital channels.

On the digital modules, you can configure the instrument to generate an alarm when a specific bit pattern or bit pattern change is detected on a digital input channel or when a specific count is reached on a totalizer channel.

Syntax: OUTPut:ALARm{1|2|3|4}:SOURce (@<ch_list>)

Query Syntax: OUTPut:ALARm{1|2|3|4}:SOURce?

Parameter: [None]

Example:

```
OUTP:ALAR3:SOUR (@101:104)
```

```
OUTP:ALAR3:SOUR?
```

Returns: #218(@101,102,103,104)

The "#2" means that the next 2 digits indicate how many characters are in the returned memory string.

In the above example, the 2 digits are the "18" after the "#2". Therefore, the remaining of the string is 18 digits long.

- An empty scan list (with no channels selected) will return "#13(@)".
-

OUTPut:ALARm:MODE

Clears the state of specified alarm output lines.

Syntax: OUTPut:ALARm:MODE {LATCH|TRACK}

Query Syntax: OUTPut:ALARm:MODE?

Parameter: LATCH | TRACK

Return parameter: LATC | TRAC

Example:

```
OUTP:ALAR:MODE LATC
```

- Latch Mode: The alarm output is asserted when a channel's reading crosses a limit, and remains asserted until you clear it manually, start a new scan, or cycle power.

- Track Mode: The alarm output is asserted when a channel's reading crosses a limit, and remains asserted only while subsequent readings remain outside the limit. When a reading returns within the limits, the output is automatically cleared.
-

OUTPut:ALARm:SLOPe

Configures the level for all four alarm output lines that indicates an alarm, either falling edge (NEG - 0 V), or rising edge (POS - 3.3 V).

Syntax: OUTPut:ALARm:SLOPe {POSitive|NEGative}

Query Syntax: OUTPut:ALARm:SLOPe?

Parameter: POSitive | NEGative

Return parameter: POS | NEG

Example:

OUTP:ALAR:SLOP POS

OUTPut:TRIGger:SLOPe

Specifies the rising edge (POS) or falling edge (NEG) as the Channel Closed signal on the rear panel Digital I/O connector. The signal operates differently during internal or external scan.

Syntax: OUTPut:TRIGger:SLOPe {POSitive|NEGative}

Query Syntax: OUTPut:TRIGger:SLOPe?

Parameter: POSitive | NEGative

Return parameter: POS | NEG

Example:

OUTP:TRIG:SLOP POS

- For internal scans (INSTrument:DMM ON command), it is generated at the END of a sweep, not the beginning of a sweep.

- For external scans (INSTrument:DMM OFF command), it is generated when each channel is closed, and can be used to trigger the measurement on the external DMM.

ROUTe Commands

ROUTe:CHANnel:ADVance:SOURce

Selects the source of signal that advances to the next channel in the scan list when scanning with an external DMM (internal DMM disabled). When the channel advance signal is received, the instrument opens the currently selected channel and closes the next channel in the scan list. The instrument will accept a software command (BUS), continuous scan trigger (IMMEDIATE), or external TTL-compatible (EXTERNAL) trigger pulse.

Syntax: ROUTe:CHANnel:ADVance:SOURce {BUS|IMMEDIATE|EXTERNAL}

Query Syntax: ROUTe:CHANnel:ADVance:SOURce?

Parameter: BUS | IMMEDIATE | EXTERNAL

Return parameter: BUS | IMM | EXT

Example:

```
ROUT:CHAN:ADV:SOUR IMM
```

ROUTe:CHANnel:DELay

Adds a delay between channels in the scan list (useful for high-impedance or high-capacitance circuits). The delay is inserted between the relay closure and the actual measurement on each channel, in addition to any delay that will implicitly occur due to relay settling time. The programmed channel delay overrides the default channel delay that the instrument automatically adds to each channel.

Syntax: ROUTe:CHANnel:DELay {<seconds>|MIN|MAX}[,@<ch_list>]

Query Syntax: ROUTe:CHANnel:DELay? [{@<ch_list>}|MIN|MAX]?

Parameter: <seconds> (0 ~ 60s)

Return parameter: <NRf>

Example:

```
ROUT:CHAN:DEL 2
```

```
ROUT:CHAN:DEL?
```

```
Returns: +2.00000000E+00
```

ROUTe:CHANnel:DELay:AUTO

Enables (On) or disables (Off) an automatic channel delay on the specified channels. If enabled, the instrument determines the delay based on function, range, integration time, and AC filter setting.

Syntax: ROUTe:CHANnel:DELay:AUTO {OFF|ON}[,(@<ch_list>)]

Query Syntax: ROUTe:CHANnel:DELay:AUTO? [(@<ch_list>)]

Parameter: 0 | 1 | OFF | ON

Return parameter: 0 | 1, (0 = OFF, 1 = ON)

Example:

```
ROUT:CHAN:DEL:AUTO ON
```

ROUTe:CHANnel:FWIRe

Configures the specified channels for 4-wire external scanning. When enabled, channel n is paired with channel n+10 (DAQ-900 or DAQ-901) or n+4 (DAQ-909) to provide source and sense connections.

Syntax: ROUTe:CHANnel:FWIRe {OFF|ON}[,(@<ch_list>)]

Query Syntax: ROUTe:CHANnel:FWIRe? [(@<ch_list>)]

Parameter: 0 | 1 | OFF | ON

Return parameter: 0 | 1, (0 = OFF, 1 = ON)

Example:

```
INST:DMM OFF  
ROUT:CHAN:FWIRe ON,(@101,102)
```

- When specifying the scan list using ROUTe:SCAN, only specify the lower channel number (n) for paired channels; the upper channel number (n+10 or n+4) is not allowed in the scan list.
-

ROUTe:CHANnel:LABel

Assigns a user-defined label to the specified channels.

Syntax: ROUTe:CHANnel:LABel "<label>",(@<ch_list>)

Query Syntax: ROUTe:CHANnel:LABel? [{USER|FACTory},](@<ch_list>)

Parameter:"<label>", max length = 30 characters

Return parameter: "<label>"

USER = Read the user-defined label on the specified channel.

FACTory = Read the factory-default label on the specified channel.

Example:

```
ROUT:CHAN:LAB "test",(@101,103)
```

```
ROUT:CHAN:LAB? USER,(@101,103)
```

Returns: "test","test"

- When shipped from the factory, each channel is assigned a unique factory-default label (cannot be overwritten).

- Specifying a null string ("") disables the user-defined message.

ROUTe:CHANnel:LABel:CLEar:MODule

Clears all user-defined labels on all channels in the specified slot, or on all modules installed in the DAQ9600, and restores the factory-default labels.

Syntax: ROUTe:CHANnel:LABel:CLEar:MODule {<slot>|ALL}

Parameter: <slot> (1 ~ 3) | ALL

Example:

```
ROUT:CHAN:LAB:CLE:MOD 1
```

- This command does not clear the factory-default channel labels. The factory-default labels are always preserved.

- The instrument keeps a record of what module types are installed in each slot. If a different module type is detected in a specific slot at power on, all user-defined channel labels for that slot are discarded. If an empty slot is detected at power-on, any previously-defined labels for that slot are preserved and will be restored if the same module type is installed later; however, if a module of a different type is installed in that slot, the previously-defined labels will be discarded.

ROUTe:CLOSE

Closes the specified channels on a multiplexer or switch module. On the multiplexer modules, if any channel on the module is defined to be part of the scan list, attempting to send this command will result in an error.

Syntax: ROUTe:CLOSE (@<ch_list>)

Query Syntax: ROUTe:CLOSE? (@<ch_list>)

Parameter: [None]

Return parameter: 0 | 1, (0 = open, 1 = close)

Example:

ROUT:CLOS (@101,102)

ROUT:CLOS? (@101,102)

Returns: 1,1

- For the matrix module (DAQ-904), the channel number represents the intersection of the desired row and column. For example, channel 312 represents the intersection of row 1 and column 2 on the module in slot 3 (assumes two-wire mode).

ROUTe:CLOSE:EXCLusive

Opens all channels on a multiplexer or switch module and then closes the specified channels. On the multiplexer modules, if any channel on the module is defined to be part of the scan list, attempting to send this command will result in an error.

Syntax: ROUTe:CLOSE:EXCLusive (@<ch_list>)

Parameter: [None]

Example:

ROUT:CLOS:EXCL (@102)

Returns: 1,1

- This command opens all channels first, and then closes the channels in the <ch_list>, one at a time. Before it closes each channel, it opens all previous channels.

ROUTe:DONE?

Returns the status of all relay operations on modules that not involved in the scan and returns a 1 when finished (even during a scan).

Return parameter: 0 | 1, (0 = Unfinished, 1 = finished)

Example:

ROUT:DONE?

Returns: 1

ROUTe:MONitor

Selects the channel to be displayed on the front panel. Only one channel can be monitored at a time.

Syntax: ROUTe:MONitor (@<channel>)

Query Syntax: ROUTe:MONitor?

Parameter: A single channel

Return parameter: <channel>

Example:

ROUT:MON (@101)

ROUT: MON?

Returns: #16(@101)

The "#1" means that the next 1 digits indicate how many characters are in the returned memory string.

In the above example, the 1 digits are the "6" after the "#1". Therefore, the remaining of the string is 6 digits long.

ROUTe:MONitor:DATA?

Reads the monitor data from the selected channel. It returns the reading only; the units, time, channel, and alarm information are not returned (the FORMat:READing commands do not apply to monitor readings).

Return parameter: <NRf>

Example:

```
ROUT:MON:STAT OFF
ROUT:MON:DATA?
```

Returns: +9.91000000E+37

- If the Monitor mode is not currently enabled, this query returns 9.91E37 (not a number).

- Readings acquired during a Monitor are not stored in reading memory but they are displayed on the front panel; however, all readings from a scan in progress at the same time are stored in reading memory.

ROUTe:MONitor:DATA:FULL?

Reads the monitor data from the selected channel. It returns all the reading with the units, time, channel, and alarm information (all the FORMat:READing enabled commands apply to this monitor readings).

Return parameter: <NRf>

Example:

```
ROUT:MON:STAT ON
ROUT:MON:DATA:FULL?
```

Returns: -1.20901311E-04 VDC,2022,04,17,20,15,08.613,201,0

- If the Monitor mode is not currently enabled, this query returns 9.91E37 (not a number).

- Readings acquired during a Monitor are not stored in reading memory but they are displayed on the front panel; however, all readings from a scan in progress at the same time are stored in reading memory.

ROUTe:MONitor:STATe

Enables (On) or disables (Off) the Monitor mode. The Monitor mode is equivalent to making continuous measurements on a single channel with an infinite scan count. Only one channel can be monitored at a time but you can change the channel being monitored at any time.

Syntax: ROUTe:MONitor:STATe {OFF|ON}

Query Syntax: ROUTe:MONitor:STATe?

Parameter: 0 | 1 | OFF | ON

Return parameter: 0 | 1, (0 = OFF, 1 = ON)

Example:

```
CONF:RES 1000,(@101)
```

```
ROUT:MON (@101)
```

```
ROUT:MON:STAT ON
```

ROUTe:MONitor:VIEW

Selects how measurement data is displayed (numeric, trend chart, histogram, and bar meter format) in monitoring mode.

Syntax: ROUTe:MONitor:VIEW {NUMeric|TCHart|HISTogram|METER}

Query Syntax: ROUTe:MONitor:VIEW?

Parameter: NUMeric | TCHart | HISTogram | METER

Return parameter: NUM | TCH | HIST | MET

Example:

```
ROUT:MON:VIEW NUM
```

ROUTe:OPEN

Opens the specified channels on a multiplexer or switch module. On the multiplexer modules, if any channel on the module is defined to be part of the scan list, attempting to send this command will result in an error.

Syntax: ROUTe:OPEN (@<ch_list>)

Query Syntax: ROUTe:OPEN? (@<ch_list>)

Return parameter: 0 | 1, (0 = close, 1 = open)

Example:

```
ROUT:OPEN (@101,102)
```

```
ROUT:OPEN? (@101,102)
```

Returns: 1,1

- For the matrix module (DAQ-904), the channel number represents the intersection of the desired row and column. For example, channel 312 represents the intersection of row 1 and column 2 on the module in slot 3 (assumes two-wire mode).

ROUTe:SCAN

Selects the channels to be included in the scan list. This command is used in conjunction with the CONFigure commands to set up an automated scan. The specified channels supersede any channels previously defined to be part of the scan list. To start the scan, use the INITiate or READ? command.

Syntax: ROUTe:SCAN (@<ch_list>)

Query Syntax: ROUTe:SCAN?

Parameter: [None]

Return parameter: <channel>

Example:

```
ROUT:SCAN (@101,102)
```

```
ROUT:SCAN?
```

Returns: #210(@101,102)

The "#2" means that the next 2 digits indicate how many characters are in the returned memory string.

In the above example, the 2 digits are the "10" after the "#2". Therefore, the remaining of the string is 10 digits long.

- To remove all channels from the present scan list, issue the command ROUT:SCAN (@).

- An empty scan list (with no channels selected) will return "#13(@)".

ROUTe:SCAN:SIZE?

Returns the number of channels in the scan list as defined by the ROUTe:SCAN command.

Return parameter: <NR1>

Example:

```
ROUT:SCAN (@101:105)
```

```
ROUT:SCAN:SIZE?
```

Returns: +5

- The present scan list is stored in non-volatile memory and will be retained when power is turned off.
-

SENSE Related Commands

[SENSE:]FUNCTION[:ON]

Selects the measurement function on the selected channels (all function-related measurement attributes are retained).

Syntax: [SENSE:]FUNCTION[:ON] "<function>"[, (@<ch_list>)]

Query Syntax: [SENSE:]FUNCTION[:ON]? [(@<ch_list>)]

Parameter:

Return Parameter:

"CAP" | "CURR:AC" | "CURR[:DC]" | "DIOD" | "FREQ" | "PER" | "FRES" |
 "RES" | "STR:DIR" | "STR:FDIR" | "STR:QUAR" | "STR:HALF:BEND" |
 "STR:HALF:POIS" | "STR:FULL:BEND" | "STR:FULL:BEND:POIS" |
 "STR:FULL:POIS" | "TEMP[:TC]" | "TEMP:FRTD" | "TEMP:RTD" |
 "TEMP:FTH" | "TEMP:THER" | "VOLT:AC" | "VOLT[:DC]"

Example:

FUNC "RES"

SENSE AVERAGE Commands

[SENSE:]AVERAGE:COUNT

Sets or returns the digital filter count.

Syntax: [SENSE:]AVERAGE:COUNT {<count>|MIN|MAX}[, (@<ch_list>)]

Query Syntax: [SENSE:]AVERAGE:COUNT? [(@<ch_list>)]MIN|MAX}

Parameter: <count> (2 ~ 100)

Return parameter: <NRf>

Example:

AVER:COUN MIN

AVER:COUN?

Returns: +0.20000000E+00

[SENSe:]AVERage:STATe

Enable(On) or disable(Off) the digital filter function state.

Syntax: [SENSe:]AVERage:STATe {OFF|ON}[,@<ch_list>]

Query Syntax: [SENSe:]AVERage:STATe? [(@<ch_list>)]

Parameter: 0 | 1 | OFF | ON

Return parameter: 0 | 1, (0 = OFF, 1 = ON)

Example:

AVER:STAT ON

- If NPLC \geq 7.2k/s, the filter function will be disabled.
-

[SENSe:]AVERage:WINDow

Sets or returns a digital filter window value.

Syntax: [SENSe:]AVERage:WINDow {<percent>|MIN|MAX}[,@<ch_list>]

Query Syntax: [SENSe:]AVERage:WINDow? [({<ch_list>})|MIN|MAX]

Parameter: <percent> (0.01 | 0.1 | 1 | 10 | NONE)

Return parameter: <NRF>

Example:

AVER:WIND 0.1

[SENSe:]AVERage:WINDow:METHod

Sets or returns a digital filter window method type.

Syntax: [SENSe:]AVERage:WINDow:METHod <type>[,@<ch_list>]

Query Syntax: [SENSe:]AVERage:WINDow:METHod? [(@<ch_list>)]

Parameters: <type> (MEASure | RANGe)

Return parameter: MEASure | RANGe

Example:

AVER:WIND:METH MEAS

SENSe CAPacitance Commands

[SENSe:]CAPacitance:RANGe

Selects a fixed range for capacitance measurements.

Syntax: [SENSe:]CAPacitance:RANGe
{<range>|MIN|MAX|DEF}{,(@<ch_list>)}
Query Syntax: [SENSe:]CAPacitance:RANGe?
[{@<ch_list>}|MIN|MAX|DEF}]

Parameter: <range> (1nF | 10nF | 100nF | 1 μ F | 10 μ F | 100 μ F); DEF:AUTO
Return parameter: <NRf>

Example:

```
CONF:CAP (@101)
CAP:RANG 1e-6
CAP:RANG?
```

Returns: +1.00000000E-06

[SENSe:]CAPacitance:RANGe:AUTO

Enables or disables autoranging for capacitance measurements.

Syntax: [SENSe:]CAPacitance:RANGe:AUTO {OFF|ON}{,(@<ch_list>)}
Query Syntax: [SENSe:]CAPacitance:RANGe:AUTO? [(@<ch_list>)]

Parameter: 0 | 1 | OFF | ON
Return parameter: 0 | 1, (0 = OFF, 1 = ON)

Example:

```
CONF:CAP (@101)
CAP:RANG:AUTO ON
```

- Autorange thresholds:
Down range at: < 10% of range
Up range at: > 120% of range
-

SENSe CURRent Commands

[SENSe:]CURRent:AC:BANDwidth

Sets or returns the ac filter bandwidth for AC current measurements.

Syntax: [SENSe:]CURRent:AC:BANDwidth
 {<freq>|MIN|MAX|DEF}, (@<ch_list>)]
 Query Syntax: [SENSe:]CURRent:AC:BANDwidth?
 [{@<ch_list>}|MIN|MAX|DEF}]

Parameter: <freq> (3 | 20 | 200Hz); DEF: 20Hz

Return parameter: <NRf>

Example:

```
CONF:CURR:AC (@121)
CURR:AC:BAND 3
CURR:AC:BAND?
```

Returns: +3.00000000E+00

[SENSe:]CURRent:{AC|DC}:RANGe

Selects a fixed range for AC and DC current measurements.

Syntax: [SENSe:]CURRent:{AC|DC}:RANGe
 {<range>|MIN|MAX|DEF}, (@<ch_list>)]
 Query Syntax: [SENSe:]CURRent:{AC|DC}:RANGe?
 [{@<ch_list>}|MIN|MAX|DEF}]

Parameter:

<range>:

AC: (100 μ A | 1mA | 10mA | 100mA | 2A); DEF:AUTO

DC: (1 μ A | 10 μ A | 100 μ A | 1mA | 10mA | 100mA | 2A); DEF:AUTO

Return parameter: <NRf>

Example:

```
CONF:CURR:AC (@121)
CURR:AC:RANG 0.1
CURR:AC:RANG?
```

Returns: +1.00000000E-01

[SENSe:]CURRent:{AC|DC}:RANGe:AUTO

Enables or disables autoranging for AC and DC current measurements.

Syntax: [SENSe:]CURRent:{AC|DC}:RANGe:AUTO
{OFF|ON}[,@<ch_list>]

Query Syntax: [SENSe:]CURRent:{AC|DC}:RANGe:AUTO? [(@<ch_list>)]

Parameter: 0 | 1 | OFF | ON

Return parameter: 0 | 1, (0 = OFF, 1 = ON)

Example:

```
CONF:CURR:AC (@101)
CURR:AC:RANG:AUTO ON
```

●Autorange thresholds:

Down range at: < 10% of range

Up range at: > 120% of range

[SENSe:]CURRent:{AC|DC}:RANGe:LOW

Selects a limit minimum current at autoranging for AC and DC current measurements.

Syntax: [SENSe:]CURRent:{AC|DC}:RANGe:LOW
{<range>|MIN|MAX|DEF}[,@<ch_list>]

Query Syntax: [SENSe:]CURRent:{AC|DC}:RANGe:LOW?
[(@<ch_list>)|MIN|MAX|DEF]

Parameter:

<range>:

AC: (100µA | 1mA | 10mA | 100mA), DEF: 100µA

DC: (1µA | 10µA | 100µA | 1mA | 10mA | 100mA) , DEF: 1µA

Return parameter: <NRf>

Example:

```
CONF:CURR:AC (@121)
CURR:AC:RANG:LOW 0.01
CURR:AC:RANG:LOW?
```

Returns: +1.00000000E-02

[SENSe:]CURRent[:DC]:APERture

Enables the aperture mode and sets the integration time in seconds (called aperture time) for DC current measurements.

Syntax: [SENSe:]CURRent[:DC]:APERture
{<seconds>|MIN|MAX|DEF}, (@<ch_list>)]
Query Syntax: [SENSe:]CURRent[:DC]:APERture?
[{@<ch_list>}]MIN|MAX|DEF}]

Parameter: <seconds> (20 μ s ~ 1s); DEF: 100ms
Return parameter: <NRf>

Example:

```
CONF:CURR:DC (@121)
CURR:APER 0.1
CURR:APER?
```

Returns: +1.00000000E-01

[SENSe:]CURRent[:DC]:APERture:ENABLE

Enables the setting of integration time in seconds (called aperture time) for DC current measurements. If aperture time mode is disabled, the integration time is set in PLC (power-line cycles).

Syntax: [SENSe:]CURRent[:DC]:APERture:ENABLE {OFF|ON}, (@<ch_list>)]
Query Syntax: [SENSe:]CURRent[:DC]:APERture:ENABLE? [{@<ch_list>}]

Parameter: 0 | 1 | OFF | ON
Return parameter: 0 | 1, (0 = OFF, 1 = ON)

Example:

```
CONF:CURR:DC (@121)
CURR:APER:ENAB ON
```

[SENSe:]CURRent[:DC]:NPLCycles

Sets or returns the integration time in number of power line cycles (PLCs) for DC current measurements. Where one PLC is equal to 16.6 milliseconds.

Syntax: [SENSe:]CURRent[:DC]:NPLCycles
{<PLCs>|MIN|MAX|DEF},{(@<ch_list>)}

Query Syntax: [SENSe:]CURRent[:DC]:NPLCycles?
[{{(@<ch_list>)|MIN|MAX|DEF}}

Parameter: <PLCs> (0.0016 | 0.0032 | 0.0042 | 0.0083 | 0.0125 | 0.025 | 0.05 | 0.15 | 0.6 | 1 | 3 | 12); DEF: 1 PLC

Return parameter: <NRf>

Example:

```
CONF:CURR (@121)
CURR:NPLC 1
CURR:NPLC?
```

Returns: +1.00000000E+00

[SENSe:]CURRent[:DC]:ZERO:AUTO

Enables or disables the autozero mode for DC current measurements.

Syntax: [SENSe:]CURRent[:DC]:ZERO:AUTO {OFF|ON},{(@<ch_list>)}

Query Syntax: [SENSe:]CURRent[:DC]:ZERO:AUTO? [(@<ch_list>)]

Parameter: 0 | 1 | OFF | ON

Return parameter: 0 | 1, (0 = OFF, 1 = ON)

Example:

```
CONF:CURR (@121)
CURR:ZERO:AUTO ON
```

SENSe DIODE Commands

[SENSe:]DIODE:ZERO:AUTO

Enables or disables the autozero mode for diode measurements.

Syntax: [SENSe:]DIODE:ZERO:AUTO {OFF|ON}[,(@<ch_list>)]

Query Syntax: [SENSe:]DIODE:ZERO:AUTO? [(@<ch_list>)]

Parameter: 0 | 1 | OFF | ON

Return parameter: 0 | 1, (0 = OFF, 1 = ON)

Example:

```
CONF:DIOD (@101)
```

```
DIOD:ZERO:AUTO ON
```

SENSe FREQuency Commands

[SENSe:]{FREQuency|PERiod}:APERture

Sets or returns the aperture time (gate time) for the frequency and period measurements.

Syntax: [SENSe:]{FREQuency|PERiod}:APERture

{<seconds>|MIN|MAX|DEF}[,(@<ch_list>)]

Query Syntax: [SENSe:]{FREQuency|PERiod}:APERture?

[{(@<ch_list>)|MIN|MAX|DEF}]

Parameter: <seconds> (0.001 | 0.01 | 0.1 | 1s); DEF: 0.1s

Return parameter: <NRf>

Example:

```
CONF:FREQ (@101)
```

```
FREQ:APER 0.1
```

```
FREQ:APER?
```

```
Returns: +1.00000000E-01
```

[SENSe:]{FREQuency|PERiod}:RANGe:LOWer

Sets or returns the ac filter bandwidth of frequency and period measurements.

Syntax: [SENSe:]{FREQuency|PERiod}:RANGe:LOWer
{<freq>|MIN|MAX|DEF},(@<ch_list>)

Query Syntax: [SENSe:]{FREQuency|PERiod}:RANGe:LOWer?
[(@<ch_list>)|MIN|MAX|DEF]

Parameter: <freq> (3 | 20 | 200Hz); DEF: 20Hz

Return parameter: <NRf>

Example:

CONF:FREQ (@101)

FREQ:RANG:LOW 3

FREQ:RANG:LOW?

Returns: +3.00000000E+00

[SENSe:]{FREQuency|PERiod}:TIMeout:AUTO

Sets or returns the timeout time for frequency and period measurements.

Syntax: [SENSe:]{FREQuency|PERiod}:TIMeout:AUTO
{OFF|ON},(@<ch_list>)

Query Syntax: [SENSe:]{FREQuency|PERiod}:TIMeout:AUTO?
[(@<ch_list>)]

Parameter: 0 | 1 | ON | OFF

Return parameter: 0 | 1, (0:timeout time = 1 second, 1:timeout time is different in according with ac filter bandwidth)

Example:

CONF:PER

PER:TIM:AUTO ON

[SENSe:]{FREQuency|PERiod}:VOLTage:RANGe

Selects a fixed voltage range for frequency and period measurements.

Syntax: [SENSe:]{FREQuency|PERiod}:VOLTage:RANGe

{<range>|MIN|MAX|DEF}[,@<ch_list>]

Query Syntax: [SENSe:]{FREQuency|PERiod}:VOLTage:RANGe?

[{@<ch_list>}|MIN|MAX|DEF]

Parameter: <range> (100mV | 1V | 10V | 100V | 400V); DEF: 10V

Return parameter: <NRf>

Example:

CONF:FREQ (@101)

FREQ:VOLT:RANG 0.1

FREQ:VOLT:RANG?

Returns: +1.00000000E-01

[SENSe:]{FREQuency|PERiod}:VOLTage:RANGe:AUTO

Enables or disables voltage autoranging for frequency and period measurements.

Syntax: [SENSe:]{FREQuency|PERiod}:VOLTage:RANGe:AUTO

{OFF|ON}[,@<ch_list>]

Query Syntax: [SENSe:]{FREQuency|PERiod}:VOLTage:RANGe:AUTO?

[{@<ch_list>}]

Parameter: 0 | 1 | OFF | ON

Return parameter: 0 | 1, (0 = OFF, 1 = ON)

Example:

CONF:FREQ (@101)

FREQ:VOLT:RANG:AUTO ON

●Autorange thresholds:

Down range at: < 10% of range

Up range at: > 120% of range

SENSE RESistance Commands

[SENSe:]{RESistance|FRESistance}:APERture

Enables the aperture mode and sets the integration time in seconds (called aperture time) for 2-wire and 4-wire resistance measurements.

Syntax: [SENSe:]{RESistance|FRESistance}:APERture
{<seconds>|MIN|MAX|DEF}[,@<ch_list>]

Query Syntax: [SENSe:]{RESistance|FRESistance}:APERture?
[(@<ch_list>)|MIN|MAX|DEF]

Parameter: <seconds> (20 μ s ~ 1s); DEF: 100ms

Return parameter: <NRf>

Example:

```
CONF:RES (@101)
RES:APER 0.1
RES:APER?
```

Returns: +1.00000000E-01

[SENSe:]{RESistance|FRESistance}:APERture:ENABle

Enables the setting of integration time in seconds (called aperture time) for 2-wire and 4-wire resistance measurements. If aperture time mode is disabled, the integration time is set in PLC (power-line cycles).

Syntax: [SENSe:]{RESistance|FRESistance}:APERture:ENABle
{OFF|ON}[,@<ch_list>]

Query Syntax: [SENSe:]{RESistance|FRESistance}:APERture:ENABle?
[(@<ch_list>)]

Parameter: 0 | 1 | OFF | ON

Return parameter: 0 | 1, (0 = OFF, 1 = ON)

Example:

```
CONF:RES (@101)
RES:APER:ENAB ON
```

[SENSe:]{RESistance|FRESistance}:NPLCycles

Sets or returns the integration time in number of power line cycles (PLCs) for 2-wire and 4-wire resistance measurements. Where one PLC is equal to 16.6 milliseconds.

Syntax: [SENSe:]{RESistance|FRESistance}:NPLCycles
{<PLCs>|MIN|MAX|DEF},(@<ch_list>)]

Query Syntax: [SENSe:]{RESistance|FRESistance}:NPLCycles?
[(@<ch_list>)|MIN|MAX|DEF}]

Parameter: <PLCs> (0.0016 | 0.0032 | 0.0042 | 0.0083 | 0.0125 | 0.025 | 0.05 | 0.15 | 0.6 | 1 | 3 | 12); DEF: 1 PLC

Return parameter: <NRf>

Example:

CONF:RES (@101)

RES:NPLC 1

RES:NPLC?

Returns: +1.00000000E+00

[SENSe:]{RESistance|FRESistance}:OCOMpensated

Enables or disables offset compensation for 2-wire and 4-wire resistance measurements.

Syntax: [SENSe:]{RESistance|FRESistance}:OCOMpensated
{OFF|ON},(@<ch_list>)]

Query Syntax: [SENSe:]{RESistance|FRESistance}:OCOMpensated?
[(@<ch_list>)]

Parameter: 0 | 1 | OFF | ON

Return parameter: 0 | 1, (0 = OFF, 1 = ON)

Example:

CONF:RES (@101)

RES:OCOM ON

- Applies only to resistance measurements on the 100 Ω through 100 k Ω ranges.
-

[SENSe:]{RESistance|FRESistance}:POWer:LIMit[:STATe]

Enables or disables low-power for 2-wire and 4-wire resistance measurements.

Syntax: [SENSe:]{RESistance|FRESistance}:POWer:LIMit[:STATe]
{OFF|ON}[,@<ch_list>]

Query Syntax: [SENSe:]{RESistance|FRESistance}:POWer:LIMit[:STATe]?
[(@<ch_list>)]

Parameter: 0 | 1 | OFF | ON

Return parameter: 0 | 1, (0 = OFF, 1 = ON)

Example:

```
CONF:RES (@101)
RES:POW:LIM ON
```

- Low-power resistance measurements apply to the 100 Ω through 100 k Ω ranges only. The 1 M Ω through 1 G Ω ranges source the same current regardless of the low-power setting.
-

[SENSe:]{RESistance|FRESistance}:RANGe

Selects a fixed range for 2-wire and 4-wire resistance measurements.

Syntax: [SENSe:]{RESistance|FRESistance}:RANGe
{<range>|MIN|MAX|DEF}[,@<ch_list>]

Query Syntax: [SENSe:]{RESistance|FRESistance}:RANGe?
[(@<ch_list>)|MIN|MAX|DEF]

Parameter:

<range> (100 Ω | 1k Ω | 10k Ω | 100k Ω | 1M Ω | 10M Ω | 100M Ω | 1G Ω); DEF:
1k Ω

Return parameter: <NRf>

Example:

```
CONF:FRES (@101)
FRES:RANG 10e3
FRES:RANG?
Returns: +1.00000000E+04
```

[SENSe:]{RESistance|FRESistance}:RANGe:AUTO

Enables or disables autoranging for 2-wire and 4-wire resistance measurements.

Syntax: [SENSe:]{RESistance|FRESistance}:RANGe:AUTO

{OFF|ON},(@<ch_list>)]

Query Syntax: [SENSe:]{RESistance|FRESistance}:RANGe:AUTO?

[(@<ch_list>)]

Parameter: 0 | 1 | OFF | ON

Return parameter: 0 | 1, (0 = OFF, 1 = ON)

Example:

CONF:FRES (@101)

FRES:RANG:AUTO ON

•Autorange thresholds:

Down range at: < 10% of range

Up range at: > 120% of range

[SENSe:]{RESistance|FRESistance}:ZERO:AUTO

Enables or disables the autozero mode for 2-wire and 4-wire resistance measurements.

Syntax: [SENSe:]{RESistance|FRESistance}:ZERO:AUTO

{OFF|ON},(@<ch_list>)]

Query Syntax: [SENSe:]{RESistance|FRESistance}:ZERO:AUTO?

[(@<ch_list>)]

Parameter: 0 | 1 | OFF | ON

Return parameter: 0 | 1, (0 = OFF, 1 = ON)

Example:

CONF:FRES (@101)

FRES:ZERO:AUTO ON

SENSE STRain Commands

[SENSE:]STRain:APERture

Enables the aperture mode and sets the integration time in seconds (called aperture time) for strain measurements.

Syntax: [SENSE:]STRain:APERture

{<seconds>|MIN|MAX|DEF}[,@<ch_list>]

Query Syntax: [SENSE:]STRain:APERture? [(@<ch_list>)|MIN|MAX|DEF]

Parameter: <seconds> (20 μ s ~ 1s); DEF: 100ms

Return parameter: <NRF>

Example:

```
CONF:STR:DIR (@101)
```

```
STR:APER 0.1
```

```
STR:APER?
```

```
Returns: +1.00000000E-01
```

[SENSE:]STRain:APERture:ENABLE

Enables the setting of integration time in seconds (called aperture time) for strain measurements. If aperture time mode is disabled, the integration time is set in PLC (power-line cycles).

Syntax: [SENSE:]STRain:APERture:ENABLE {OFF|ON}[,@<ch_list>]

Query Syntax: [SENSE:]STRain:APERture:ENABLE? [(@<ch_list>)]

Parameter: 0 | 1 | OFF | ON

Return parameter: 0 | 1, (0 = OFF, 1 = ON)

Example:

```
CONF:STR:DIR (@101)
```

```
STR:APER:ENAB ON
```

[SENSe:]STRain:EXCitation

Specifies the excitation voltage applied to the bridge by an external DC voltage source. This value will be used to convert strain bridge measurements on the specified channel.

Syntax: [SENSe:]STRain:EXCitation

{<voltage>|MIN|MAX|DEF}[,@<ch_list>]

Query Syntax: [SENSe:]STRain:EXCitation? [(@<ch_list>)|MIN|MAX|DEF]

Parameter: <voltage> (1 ~ 12V); DEF: 5V

Return parameter: <NRf>

Example:

```
CONF:STR:DIR (@101)
```

```
STR:EXC 3
```

```
STR:EXC?
```

Returns: +3.00000000E+00

- The external DC voltage reference channel must be the next lowest channel than the subsequent strain channel.

[SENSe:]STRain:EXCitation:TYPE

Strain bridge conversions require the value of the external bridge excitation voltage. For this voltage, you can dedicate a multiplexer channel to measure the excitation voltage, or can specify a known fixed voltage value.

Syntax: [SENSe:]STRain:EXCitation:TYPE {EXTernal|FIXed}[,@<ch_list>]

Query Syntax: [SENSe:]STRain:EXCitation:TYPE? [(@<ch_list>)]

Parameter: EXTernal | FIXed

Return parameter: EXT | FIX

FIXed = the excitation voltage specified by SENSE:STRain:EXCitation will be used for the strain conversion.

EXTernal = the next-lowest channel configured for DCV measurements with reference mode enabled (see SENSE:VOLTage:DC:REFerence command) will be used as the excitation voltage reference in the strain conversion.

Example:

```
CONF:STR:DIR (@101)
```

```
STR:EXC:TYPE FIX
```

```
STR:EXC 3
```

[SENSe:]STRain:GFACTor

Specifies the gage factor to be used to convert direct strain and strain bridge readings on the specified channel.

Gage factor is defined as the ratio of the fractional change in resistance to the fractional change in length (strain) along the axis of the edge.

Syntax: [SENSe:]STRain:GFACTor

{<gage_factor>|MIN|MAX|DEF},{(@<ch_list>)}

Query Syntax: [SENSe:]STRain:GFACTor? [{@<ch_list>}|MIN|MAX|DEF]

Parameter: <gage_factor> (0.5 ~ 5); DEF: 2

Return parameter: <NRf>

Example:

CONF:STR:DIR (@101)

STR:GFAC 1

STR:GFAC?

Returns: +1.00000000E+00

- Gage factor is a dimensionless quantity. The larger the value, the more sensitive strain gage.
-

[SENSe:]STRain:NPLCycles

Sets or returns the integration time in number of power line cycles (PLCs) strain measurements. Where one PLC is equal to 16.6 milliseconds.

Syntax: [SENSe:]STRain:NPLCycles {<PLCs>|MIN|MAX|DEF},{(@<ch_list>)}

Query Syntax: [SENSe:]STRain:NPLCycles? [{@<ch_list>}|MIN|MAX|DEF]

Parameter: <PLCs> (0.0016 | 0.0032 | 0.0042 | 0.0083 | 0.0125 | 0.025 | 0.05 | 0.15 | 0.6 | 1 | 3 | 12); DEF: 1 PLC

Return parameter: <NRf>

Example:

CONF:STR:DIR (@101)

STR:NPLC 1

STR:NPLC?

Returns: +1.00000000E+00

[SENSe:]STRain:OCOMpensated

Enables or disables offset compensation for strain measurements.

Syntax: [SENSe:]STRain:OCOMpensated {OFF|ON}[,(@<ch_list>)]

Query Syntax: [SENSe:]STRain:OCOMpensated? [(@<ch_list>)]

Parameter: 0 | 1 | OFF | ON

Return parameter: 0 | 1, (0 = OFF, 1 = ON)

Example:

```
CONF:STR:DIR (@101)
```

```
STR:OCOM ON
```

- Applies only to resistance measurements on the 100 Ω through 100 k Ω ranges.
-

[SENSe:]STRain:POISson

This command sets the poisson ratio to be used to convert strain bridge readings on the specified channels.

Poisson ratio is defined as the negative ratio of the strain the transverse direction to the strain the longitudinal direction.

Syntax: [SENSe:]STRain:POISson

{<poisson_ratio>|MIN|MAX|DEF}[,(@<ch_list>)]

Query Syntax: [SENSe:]STRain:POISson? [{(@<ch_list>)|MIN|MAX|DEF}]

Parameter: <poisson_ratio> (-0.9999 ~ 0.5); DEF: 0.3

Return parameter: <NRf>

Example:

```
CONF:STR:DIR (@101)
```

```
STR:POIS 1
```

```
STR:POIS?
```

```
Returns: +1.00000000E+00
```

[SENSe:]STRain:RESistance

This command specifies the gage ohm value to be used to convert direct strain measurements on the specified channel.

Syntax: [SENSe:]STRain:RESistance

{<gage_ohm>|MIN|MAX|DEF}[,@<ch_list>]

Query Syntax: [SENSe:]STRain:RESistance? [{{@<ch_list>}|MIN|MAX|DEF}]

Parameter: <gage_ohm> (80 ~ 1100 Ω); DEF: 120 Ω

Return parameter: <NRf>

Example:

CONF:STR:DIR (@101)

STR:RES 100

STR:RES?

Returns: +1.00000000E+02

[SENSe:]STRain:UNSTrained

This command specifies the unstrained bridge offset (can be either voltage or resistance) that will be subtracted from the strain bridge measurements before the strain conversion is performed strain bridge measurements.

Syntax: [SENSe:]STRain:UNSTrained

{<offset>|MIN|MAX|DEF}[,@<ch_list>]

Query Syntax: [SENSe:]STRain:UNSTrained?

[{{@<ch_list>}|MIN|MAX|DEF}]

Parameter: <offset> (-90 ~ 90); DEF: 0

Return parameter: <NRf>

Example:

CONF:STR:DIR (@101)

STR:UNST 10

STR:UNST?

Returns: +1.00000000E+01

[SENSe:]STRain:UNSTrained:IMMEDIATE

This command immediately measures and stores the bridge offset voltages on the specified channel.

Syntax: [SENSe:]STRain:UNSTrained:IMMEDIATE [(@<ch_list>)]

Parameter: [None]

Example:

CONF:STR:QUAR (@101)

STR:UNST:IMM

STR:UNST?

Returns: -9.055960E-05

[SENSe:]STRain:VOLTage:RANGe

Selects a fixed range for strain measurements.

Syntax: [SENSe:]STRain:VOLTage:RANGe

{<range>|MIN|MAX|DEF}, (@<ch_list>)]

Query Syntax: [SENSe:]STRain:VOLTage:RANGe?

[{@<ch_list>}|MIN|MAX|DEF}]

Parameter:

<range> (100mV | 1V | 10V | 100V | 600V); DEF: 100mV

Return parameter: <NRf>

Example:

CONF:STR:QUAR (@101)

STR:VOLT:RANG 10

Returns: +1.00000000E+01

[SENSe:]STRain:VOLTage:RANGe:AUTO

Enables or disables autoranging for strain measurements.

Syntax: [SENSe:]STRain:VOLTage:RANGe:AUTO {OFF|ON}, (@<ch_list>)]

Query Syntax: [SENSe:]STRain:VOLTage:RANGe:AUTO? [(@<ch_list>)]

Parameter: 0 | 1 | OFF | ON

Return parameter: 0 | 1, (0 = OFF, 1 = ON)

Example:

CONF:STR:QUAR (@101)

STR:VOLT:RANG:AUTO ON

●Autorange thresholds:

Down range at: < 10% of range

Up range at: > 120% of range

[SENSe:]STRain:ZERO:AUTO

Enables or disables the autozero mode for strain measurements.

Syntax: [SENSe:]STRain:ZERO:AUTO {OFF|ON}[,@<ch_list>]

Query Syntax: [SENSe:]STRain:ZERO:AUTO? [(@<ch_list>)]

Parameter: 0 | 1 | OFF | ON

Return parameter: 0 | 1, (0 = OFF, 1 = ON)

Example:

```
CONF:STR:DIR (@101)
```

```
STR:ZERO:AUTO ON
```

SENSe TEMPerature Commands

[SENSe:]TEMPerature:APERture

Enables the aperture mode and sets the integration time in seconds (called aperture time) for temperature measurements.

Syntax: [SENSe:]TEMPerature:APERture
{<seconds>|MIN|MAX|DEF}[,@<ch_list>]

Query Syntax: [SENSe:]TEMPerature:APERture?
[(@<ch_list>)|MIN|MAX|DEF]

Parameter: <seconds> (20 μ s ~ 1s); DEF: 100ms

Return parameter: <NRf>

Example:

```
CONF:TEMP TC,(@101)
```

```
TEMP:APER 0.5
```

```
TEMP:APER?
```

```
Returns: +5.00000000E-01
```

[SENSe:]TEMPerature:APERture:ENABLE

Enables the setting of integration time in seconds (called aperture time) for temperature measurements. If aperture time mode is disabled, the integration time is set in PLC (power-line cycles).

Syntax: [SENSe:]TEMPerature:APERture:ENABLE {OFF|ON}, (@<ch_list>)]

Query Syntax: [SENSe:]TEMPerature:APERture:ENABLE? [(@<ch_list>)]

Parameter: 0 | 1 | OFF | ON

Return parameter: 0 | 1, (0 = OFF, 1 = ON)

Example:

```
CONF:TEMP TC, (@101)
TEMP:APER:ENAB ON
```

[SENSe:]TEMPerature:NPLCycles

Sets or returns the integration time in number of power line cycles (PLCs) temperature measurements. Where one PLC is equal to 16.6 milliseconds.

Syntax: [SENSe:]TEMPerature:NPLCycles

{<PLCs>|MIN|MAX|DEF}, (@<ch_list>)]

Query Syntax: [SENSe:]TEMPerature:NPLCycles?

[{(@<ch_list>)|MIN|MAX|DEF}]

Parameter: <PLCs> (0.0016 | 0.0032 | 0.0042 | 0.0083 | 0.0125 | 0.025 | 0.05 | 0.15 | 0.6 | 1 | 3 | 12); DEF: 1 PLC

Return parameter: <NRf>

Example:

```
CONF:TEMP TC, (@101)
TEMP:NPLC 3
TEMP:NPLC?
Returns: +3.00000000E+00
```

[SENSe:]TEMPerature:RJUNction?

Returns the internal reference junction temperature on the specified channels in degrees Celsius, regardless of the temperature units currently selected. This is useful only for an internal reference source.

Query Syntax: [SENSe:]TEMPerature:RJUNction? [(@<ch_list>)]

Return parameter: <NRf>

Example:

```
CONF:TEMP TC, (@101)
TEMP:RJUN?
Returns: +2.76800914E+01
```

[SENSe:]TEMPerature:RJUNction:SIMulated:AUTO:OFFSet

Sets or returns junction reference temperature adjust value of thermocouple measurement which internal temperature is selected.

Syntax: [SENSe:]TEMPerature:RJUNction:SIMulated:AUTO:OFFSet
{<temperature>|MIN|MAX|DEF}, (@<ch_list>)]

Query Syntax: [SENSe:]TEMPerature:RJUNction:SIMulated:AUTO:OFFSet?
[{{@<ch_list>}|MIN|MAX|DEF}]

Parameter: <temperature> (-20.00 ~ 20.00); DEF:0

Return parameter: <NRf>, where unit = °C

Example:

```
CONF:TEMP TC, (@101)
TEMP:RJUN:SIM:AUTO:OFFS 10
TEMP:RJUN:SIM:AUTO:OFFS?
```

Returns: +1.00000000E+01

[SENSe:]TEMPerature:TRANsdruceR:{RTD|FRTD}:TYPE

Selects the 2-wire and 4-wire RTD sensor type.

Syntax: [SENSe:]TEMPerature:TRANsdruceR:{RTD|FRTD}:TYPE
<sensor_type>[, (@<ch_list>)]

Query Syntax: [SENSe:]TEMPerature:TRANsdruceR:{RTD|FRTD}:TYPE?
[(@<ch_list>)]

parameter: <sensor_type> (PT100 | D100 | F100 | PT385 | PT3916 | USER)

Return parameter: PT100 | D100 | F100 | PT385 | PT3916 | USER

Example:

```
TEMP:TRAN:RTD:TYPE PT100
```

[SENSe:]TEMPerature:TRANsdruceR:{RTD|FRTD}:USER:ALPHa

Sets or returns the 2-wire and 4-wire RTD alpha coefficient.

Syntax: [SENSe:]TEMPerature:TRANsdruceR:{RTD|FRTD}:USER:ALPHa
{<coefficient>|MIN|MAX|DEF}, (@<ch_list>)]

Query Syntax:

[SENSe:]TEMPerature:TRANsdruceR:{RTD|FRTD}:USER:ALPHa?
[{{@<ch_list>}|MIN|MAX|DEF}]

Parameter: <coefficient> (0.0~9.999999); DEF: 0

Return parameter: <NRf>

Example:

```
TEMP:TRAN:RTD:USER:ALPH 0.00385
```

[SENSe:]TEMPerature:TRANsducer:{RTD|FRTD}:USER:BETA

Sets or returns the 2-wire and 4-wire RTD beta coefficient.

Syntax: [SENSe:]TEMPerature:TRANsducer:{RTD|FRTD}:USER:BETA
{<coefficient>|MIN|MAX|DEF}[,@<ch_list>]

Query Syntax: [SENSe:]TEMPerature:TRANsducer:{RTD|FRTD}:USER:BETA?
[{@<ch_list>}|MIN|MAX|DEF]

Parameter: <coefficient> (0.0~9.999999); DEF: 0

Return parameter: <NRf>

Example:

TEMP:TRAN:RTD:USER:BETA 0.10863

[SENSe:]TEMPerature:TRANsducer:{RTD|FRTD}:USER:DELTA

Sets or returns the 2-wire and 4-wire RTD delta coefficient.

Syntax: [SENSe:]TEMPerature:TRANsducer:{RTD|FRTD}:USER:DELTA
{<coefficient>|MIN|MAX|DEF}[,@<ch_list>]

Query Syntax:

[SENSe:]TEMPerature:TRANsducer:{RTD|FRTD}:USER:DELTA?
[{@<ch_list>}|MIN|MAX|DEF]

Parameter: <coefficient> (0.0~9.999999); DEF: 0

Return parameter: <NRf>

Example:

TEMP:TRAN:RTD:USER:DELT 1.4999

[SENSe:]TEMPerature:TRANsducer:{RTD|FRTD}:OCOMpensated
 Enables or disables offset compensation for temperature measurements.

Syntax: [SENSe:]TEMPerature:TRANsducer:{RTD|FRTD}:OCOMpensated
 {OFF|ON}[,@<ch_list>]

Query Syntax:

[SENSe:]TEMPerature:TRANsducer:{RTD|FRTD}:OCOMpensated?
 [(@<ch_list>)]

Parameter: 0 | 1 | OFF | ON

Return parameter: 0 | 1, (0 = OFF, 1 = ON)

Example:

```
CONF:TEMP RTD,(@101)
TEMP:TRAN:RTD:OCOM ON
```

- This command applies only to 2-wire and 4-wire RTD measurements on the 100 Ω , 1 k Ω , and 10 k Ω ranges. Once enabled, offset compensation is applied to both 2-wire and 4-wire RTD measurements on the specified channels.

- Applies only to resistance measurements on the 100 Ω through 100 k Ω ranges.

[SENSe:]TEMPerature:TRANsducer:{RTD|FRTD}:POWER:LIMit[:STAT
 e]

Enables or disables low-power for 2-wire and 4-wire RTD measurements.

Syntax:

[SENSe:]TEMPerature:TRANsducer:{RTD|FRTD}:POWER:LIMit[:STATe]
 {OFF|ON}[,@<ch_list>]

Query Syntax:

[SENSe:]TEMPerature:TRANsducer:{RTD|FRTD}:POWER:LIMit[:STATe]?
 [(@<ch_list>)]

Parameter: 0 | 1 | OFF | ON

Return parameter: 0 | 1, (0 = OFF, 1 = ON)

Example:

```
CONF:TEMP RTD,(@101)
TEMP:TRAN:RTD:POW:LIM ON
```

- Low-power resistance measurements apply to the 100 Ω through 100 k Ω ranges only. The 1 M Ω through 1 G Ω ranges source the same current regardless of the low-power setting.

[SENSe:]TEMPerature:TRANsducer:{RTD|FRTD}:REFerence
 Enables (On) or disables (Off) the specified 2-wire and 4-wire RTD channels to be used as the reference channel for subsequent thermocouple measurements that specify an external reference source.

Syntax: [SENSe:]TEMPerature:TRANsducer:{RTD|FRTD}:REFerence {OFF|ON},(@<ch_list>)]

Query Syntax: [SENSe:]TEMPerature:TRANsducer:{RTD|FRTD}:REFerence? [(@<ch_list>)]

Parameter: 0 | 1 | OFF | ON

Return parameter: 0 | 1, (0 = OFF, 1 = ON)

Example:

```
CONF:TEMP RTD,(@101)
TEMP:TRAN:RTD:REF ON
```

[SENSe:]TEMPerature:TRANsducer:{RTD|FRTD}:RESistance[:REFerence]

Selects the nominal resistance (R0) for 2-wire and 4-wire RTD measurements. R0 is the nominal resistance of an RTD at 0 °C.

Syntax:

[SENSe:]TEMPerature:TRANsducer:{RTD|FRTD}:RESistance[:REFerence] {<resistance>|MIN|MAX|DEF},(@<ch_list>)]

Query Syntax:

[SENSe:]TEMPerature:TRANsducer:{RTD|FRTD}:RESistance[:REFerence]? [({@<ch_list>})|MIN|MAX|DEF]]

Parameter: <resistance> (100 ~ 1000Ω)±20%; DEF: 100Ω

Return parameter: <NRf>

Example:

```
CONF:TEMP RTD,(@101)
TEMP:TRAN:RTD:RES 1000
TEMP:TRAN:RTD:RES?
Returns: +1.00000000E+03
```

[SENSe:]TEMPerature:TRANsducer:{THERmistor|FTHERmistor}:POWer:LIMit[:STATe]

Enables or disables low-power for 2-wire and 4-wire thermistor measurements.

Syntax:

[SENSe:]TEMPerature:TRANsducer:{THERmistor|FTHERmistor}:POWer:LIMit[:STATe] {OFF|ON}, (@<ch_list>)]

Query Syntax:

[SENSe:]TEMPerature:TRANsducer:{THERmistor|FTHERmistor}:POWer:LIMit[:STATe]? [(@<ch_list>)]

Parameter: 0 | 1 | OFF | ON

Return parameter: 0 | 1, (0 = OFF, 1 = ON)

Example:

```
CONF:TEMP THER,(@101)
TEMP:TRAN:THER:POW:LIM ON
```

- Low-power resistance measurements apply to the 100 Ω through 100 k Ω ranges only. The 1 M Ω through 1 G Ω ranges source the same current regardless of the low-power setting.
-

[SENSe:]TEMPerature:TRANsducer:{THERmistor|FTHERmistor}:REFerence

Enables (On) or disables (Off) the specified 2-wire and 4-wire thermistor channels to be used as the reference channel for subsequent thermocouple measurements that specify an external reference source.

Syntax:

[SENSe:]TEMPerature:TRANsducer:{THERmistor|FTHERmistor}:REFerence {OFF|ON}, (@<ch_list>)]

Query Syntax:

[SENSe:]TEMPerature:TRANsducer:{THERmistor|FTHERmistor}:REFerence? [(@<ch_list>)]

Parameter: 0 | 1 | OFF | ON

Return parameter: 0 | 1, (0 = OFF, 1 = ON)

Example:

```
CONF:TEMP THER,(@101)
TEMP:TRAN:THER:REF ON
```

[SENSe:]TEMPerature:TRANsducer:{THERmistor|FTHermistor}:TYPE

Sets or returns the 2-wire and 4-wire thermistor sensor type.

Syntax:

[SENSe:]TEMPerature:TRANsducer:{THERmistor|FTHermistor}:TYPE
{<sensor_type>|MIN|MAX|DEF}[,(@<ch_list>)]

Query Syntax:

[SENSe:]TEMPerature:TRANsducer:{THERmistor|FTHermistor}:TYPE?
[{@<ch_list>}]MIN|MAX|DEF}]

Parameter: <sensor_type> (2.2k Ω | 5k Ω | 10k Ω | USER); DEF: 5k Ω

Return parameter: +2000 | +5000 | +10000 | USER

Example:

TEMP:TRAN:THER:TYPE 2200

[SENSe:]TEMPerature:TRANsducer:{THERmistor|FTHermistor}:USER:AVAlue

Sets or returns the 2-wire and 4-wire thermistor a coefficient.

Syntax:

[SENSe:]TEMPerature:TRANsducer:{THERmistor|FTHermistor}:USER:AVAlue
{<coefficient>|MIN|MAX|DEF}[,(@<ch_list>)]

Query Syntax:

[SENSe:]TEMPerature:TRANsducer:{THERmistor|FTHermistor}:USER:AVAlue?
[{@<ch_list>}]MIN|MAX|DEF}]

Parameter: <coefficient> (0.0~9.9999); DEF: 0

Return parameter: <NRf>

Example:

TEMP:TRAN:FTH :USER:AVAl 0.002154

[SENSe:]TEMPerature:TRANsducer:{THERmistor|FTHERmistor}:USER:BVALue

Sets or returns the 2-wire and 4-wire thermistor b coefficient.

Syntax:

[SENSe:]TEMPerature:TRANsducer:{THERmistor|FTHERmistor}:USER:BVALue {<coefficient>|MIN|MAX|DEF}[,@<ch_list>]

Query Syntax:

[SENSe:]TEMPerature:TRANsducer:{THERmistor|FTHERmistor}:USER:BVALue? [{@<ch_list>}|MIN|MAX|DEF]

Parameter: <coefficient> (0.0~9.9999); DEF: 0

Return parameter: <NRf>

Example:

TEMP:TRAN:FTH :USER:BVAL 0.003425

[SENSe:]TEMPerature:TRANsducer:{THERmistor|FTHERmistor}:USER:CVALue

Sets or returns the 2-wire and 4-wire thermistor c coefficient.

Syntax:

[SENSe:]TEMPerature:TRANsducer:{THERmistor|FTHERmistor}:USER:CVALue {<coefficient>|MIN|MAX|DEF}[,@<ch_list>]

Query Syntax:

[SENSe:]TEMPerature:TRANsducer:{THERmistor|FTHERmistor}:USER:CVALue? [{@<ch_list>}|MIN|MAX|DEF]

Parameter: <coefficient> (0.0~9.9999); DEF: 0

Return parameter: <NRf>

Example:

TEMP:TRAN:FTH:USER:CVAL 0.006993

[SENSe:]TEMPerature:TRANsducer:TCouple:CHECK

Enables or disables the thermocouple check feature to verify that your thermocouples are properly connected for measurements. When enabled, the instrument measures the resistance after each thermocouple measurement to ensure a proper connection. If an open connection is detected (greater than 5 k Ω on the 10 k Ω range), the instrument reports an overload condition.

Syntax: [SENSe:]TEMPerature:TRANsducer:TCouple:CHECK

{OFF|ON},{(@<ch_list>)}

Query Syntax: [SENSe:]TEMPerature:TRANsducer:TCouple:CHECK?

[{@<ch_list>}]

Parameter: 0 | 1 | OFF | ON

Return parameter: 0 | 1, (0 = OFF, 1 = ON)

Example:

```
CONF:TEMP TC,(@101)
```

```
TEMP:TRAN:TC:CHEC ON
```

[SENSe:]TEMPerature:TRANsducer:TCouple:RJUNction

Sets the fixed reference junction temperature in degrees Celsius ($^{\circ}$ C) for thermocouple measurements on the specified channels.

Syntax: [SENSe:]TEMPerature:TRANsducer:TCouple:RJUNction

{<temperature>|MIN|MAX|DEF},{(@<ch_list>)}

Query Syntax: [SENSe:]TEMPerature:TRANsducer:TCouple:RJUNction?

[{@<ch_list>}|MIN|MAX|DEF}]

Parameter: <temperature> (-20 ~ +80); DEF: 0

Return parameter: <NRf>

Example:

```
CONF:TEMP TC,(@101)
```

```
TEMP:TRAN:TC:RJUN 25
```

```
Returns: +2.50000000E+01
```

- For this command, you must always specify the temperature in degrees Celsius regardless of the temperature units currently selected (see UNIT:TEMPerature command).
-

[SENSe:]TEMPerature:TRANsducer:TCouple:RJUNction:TYPE

Selects the reference junction source for thermocouple measurements on the specified channels.

Syntax: [SENSe:]TEMPerature:TRANsducer:TCouple:RJUNction:TYPE
<reference>[, (@<ch_list>)]

Query Syntax:

[SENSe:]TEMPerature:TRANsducer:TCouple:RJUNction:TYPE?
[(@<ch_list>)]

Parameter: <reference> (INTernal | EXTeranl | FIXed)

Return parameter: INT | EXT | FIX

Example:

```
CONF :TEMP TC,(@101)
TEMP:TRAN:TC:RJUN:TYPE INT
```

[SENSe:]TEMPerature:TRANsducer:TCouple:TYPE

Sets or returns the thermocouple sensor type.

Syntax: [SENSe:]TEMPerature:TRANsducer:TCouple:TYPE
<sensor_type>[, (@<ch_list>)]

Query Syntax: [SENSe:]TEMPerature:TRANsducer:TCouple:TYPE?
[(@<ch_list>)]

Parameter: <sensor_type> (J | K | N | R | S | T | B | E)

Return parameter: J | K | N | R | S | T | B | E

Example:

```
TEMP:TRAN:TC:TYPE J
```

[SENSe:]TEMPerature:TRANsducer:TYPE

Selects the transducer probe type to use for temperature measurements.

Syntax: [SENSe:]TEMPerature:TRANsducer:TYPE
<probe_type>[, (@<ch_list>)]

Query Syntax: [SENSe:]TEMPerature:TRANsducer:TYPE? [(@<ch_list>)]

Parameter: TCouple | RTD | FRTD | THERmistor | FTHERmistor

Return parameter: TC | RTD | FRTD | THER | FTH

Example:

```
TEMP:TRAN:TYPE TC
```

[SENSe:]TEMPerature:ZERO:AUTO

Enables or disables the autozero mode for temperature measurements.

Syntax: [SENSe:]TEMPerature:ZERO:AUTO {OFF|ON}[,(@<ch_list>)]

Query Syntax: [SENSe:]TEMPerature:ZERO:AUTO? [(@<ch_list>)]

Parameter: 0 | 1 | OFF | ON

Return parameter: 0 | 1, (0 = OFF, 1 = ON)

Example:

```
CONF:TEMP TC,(@101)
```

```
TEMP:ZERO:AUTO ON
```

SENSe VOLTage Commands

[SENSe:]VOLTage:AC:BANDwidth

Sets or returns the bandwidth for AC voltage measurements.

Syntax: [SENSe:]VOLTage:AC:BANDwidth

{<freq>|MIN|MAX|DEF}[,(@<ch_list>)]

Query Syntax: [SENSe:]VOLTage:AC:BANDwidth?

[{(@<ch_list>)|MIN|MAX|DEF}]

Parameter: <freq> (3 | 20 | 200Hz) ; DEF: 20Hz

Return parameter: <NRf>

Example:

```
CONF:AC (@101)
```

```
VOLT:AC:BAND 20
```

```
VOLT:AC:BAND?
```

```
Returns: +2.00000000E+01
```

[SENSe:]VOLTage:{AC|DC}:RANGe

Selects a fixed range for AC and DC voltage measurements.

Syntax: [SENSe:]VOLTage:{AC|DC}:RANGe

{<range>|MIN|MAX|DEF}[,@<ch_list>]

Query Syntax: [SENSe:]VOLTage:{AC|DC}:RANGe?

[{(@<ch_list>)|MIN|MAX|DEF}]

Parameter:

<range>:

AC: (100mV | 1V | 10V | 100V | 400V); DEF: AUTO

DC: (100mV | 1V | 10V | 100V | 600V); DEF: AUTO

Return parameter: <NRF>

Example:

CONF:AC (@101)

VOLT:AC:RANG 100

Returns: +1.00000000E+02

[SENSe:]VOLTage:{AC|DC}:RANGe:AUTO

Enables or disables autoranging for AC and DC voltage measurements.

Syntax: [SENSe:]VOLTage:{AC|DC}:RANGe:AUTO {OFF|ON}[,@<ch_list>]

Query Syntax: [SENSe:]VOLTage:{AC|DC}:RANGe:AUTO? [(@<ch_list>)]

Parameter: 0 | 1 | OFF | ON

Return parameter: 0 | 1, (0 = OFF, 1 = ON)

Example:

CONF:DC (@101)

VOLT:DC:RANG:AUTO ON

●Autorange thresholds:

Down range at: < 10% of range

Up range at: > 120% of range

[SENSe:]VOLTage[:DC]:APERture

Enables the aperture mode and sets the integration time in seconds (called aperture time) for DC voltage measurements.

Syntax: [SENSe:]VOLTage[:DC]:APERture

{<seconds>|MIN|MAX|DEF}, (@<ch_list>)]

Query Syntax: [SENSe:]VOLTage[:DC]:APERture?

[{@<ch_list>}|MIN|MAX|DEF]

Parameter: <seconds> (20 μ s ~ 1s); DEF: 100ms

Return parameter: <NRf>

Example:

CONF:DC (@101)

VOLT:APER 0.1

VOLT:APER ?

Returns: +1.00000000E-01

[SENSe:]VOLTage[:DC]:APERture:ENABLE

Enables the setting of integration time in seconds (called aperture time) for DC voltage measurements. If aperture time mode is disabled, the integration time is set in PLC (power-line cycles).

Syntax: [SENSe:]VOLTage[:DC]:APERture:ENABLE {OFF|ON}, (@<ch_list>)]

Query Syntax: [SENSe:]VOLTage[:DC]:APERture:ENABLE? [{@<ch_list>}]

Parameter: 0 | 1 | OFF | ON

Return parameter: 0 | 1, (0 = OFF, 1 = ON)

Example:

CONF:DC (@101)

VOLT:APER:ENAB ON

[SENSe:]VOLTage[:DC]:IMPedance:AUTO

Enables or disables automatic input impedance mode for DC voltage measurements.

Syntax: [SENSe:]VOLTage[:DC]:IMPedance:AUTO {OFF|ON}[,@<ch_list>]

Query Syntax: [SENSe:]VOLTage[:DC]:IMPedance:AUTO? [(@<ch_list>)]

Parameter: 0 | 1 | OFF | ON

Return parameter: 0 | 1, (0 = OFF, 1 = ON)

OFF:

The input impedance for DC voltage measurements is fixed at 10 M Ω for all ranges to minimize noise pickup.

ON:

The input impedance for DC voltage measurements varies by range. It is set to "HI-Z" (>10 G Ω) for the 100 mV, 1 V, and 10 V ranges to reduce the effects of measurement loading errors on these lower ranges. The 100 V and 300 V ranges remain at a 10 M Ω input impedance.

Example:

```
CONF:DC (@101)
VOLT:DC:IMP:AUTO ON
```

[SENSe:]VOLTage[:DC]:NPLCycles

Sets or returns the integration time in number of power line cycles (PLCs) DC voltage measurements. Where one PLC is equal to 16.6 milliseconds.

Syntax: [SENSe:]VOLTage[:DC]:NPLCycles

{<PLCs>|MIN|MAX|DEF}[,@<ch_list>]

Query Syntax: [SENSe:]VOLTage[:DC]:NPLCycles?

[{(@<ch_list>)|MIN|MAX|DEF}]

Parameter: <PLCs> (0.0016 | 0.0032 | 0.0042 | 0.0083 | 0.0125 | 0.025 | 0.05 | 0.15 | 0.6 | 1 | 3 | 12); DEF: 1 PLC

Return parameter: <NRf>

Example:

```
CONF:DC (@101)
VOLT:NPLC 1
VOLT:NPLC?
```

Returns: +1.00000000E+00

[SENSe:]VOLTage[:DC]:REFerence

Enables (On) or disables (Off) the specified DC voltage channels to be used as the reference channel for subsequent strain bridge measurements that specify an external excitation reference voltage source (see [SENSe:]STRain:EXCitation:TYPE command).

Syntax: [SENSe:]VOLTage[:DC]:REFerence {OFF|ON}[,@<ch_list>]

Query Syntax: [SENSe:]VOLTage[:DC]:REFerence? [(@<ch_list>)]

Parameter: 0 | 1 | OFF | ON

Return parameter: 0 | 1, (0 = OFF, 1 = ON)

Example:

```
CONF:DC (@101)
```

```
VOLT:REF ON
```

- The external DC voltage reference channel must be one channel lower than the subsequent strain channel.
-

[SENSe:]VOLTage[:DC]:ZERO:AUTO

Enables or disables the autozero mode for DC voltage measurements.

Syntax: [SENSe:]VOLTage[:DC]:ZERO:AUTO {OFF|ON}[,@<ch_list>]

Query Syntax: [SENSe:]VOLTage[:DC]:ZERO:AUTO? [(@<ch_list>)]

Parameter: 0 | 1 | OFF | ON

Return parameter: 0 | 1, (0 = OFF, 1 = ON)

Example:

```
CONF:DC (@101)
```

```
VOLT:ZERO:AUTO ON
```

STATus Report Commands

STATus:ALARm:CONDition?

Returns the total number of the Alarm Condition register.

Return parameter: <NR1> (0 ~ 32767)

Example:

```
STAT:ALAR:COND?
```

Returns: +16

- A condition register continuously monitors the state of the instrument. Condition register bits are updated in real time; they are neither latched nor buffered.

- This register is read-only; bits are not cleared when read.

STATus:ALARm:ENABle

Sets or returns bits in the Alarm Enable register.

Syntax: STATus:ALARm:ENABle <enable>

Query Syntax: STATus:ALARm:ENABle?

Parameter: <enable> (0 ~ 32767)

Return parameter: <NR1>

Example:

```
STAT:ALAR:ENAB 7
```

- The selected bits are then reported to the Status Byte. An enable register defines which bits in the event register will be reported to the Status Byte register group. You can write to or read from an enable register.

STATus:ALARm[:EVENT]?

Returns the total number of the Alarm Event register.

Return parameter: <NR1>

Example:

STAT:ALAR:EVENT?

Returns: +7

- An event register is a read-only register that latches events from the condition register. While an event bit is set, subsequent events corresponding to that bit are ignored.
 - Once a bit is set, it remains set until cleared by reading the event register or by sending *CLS (clear status). This register is read-only; bits are not cleared when read.
-

STATus:OPERation:CONDition?

Returns the total number of the Operation Condition register.

Return parameter: <NR1> (0 ~ 32767)

Example:

STAT:OPER:COND?

Returns: +4096

- A condition register continuously monitors the state of the instrument. Condition register bits are updated in real time; they are neither latched nor buffered.
 - This register is read-only; bits are not cleared when read.
-

STATus:OPERation:ENABle

Sets or returns bits in the Operation Enable register.

Syntax: STATus:OPERation:ENABle <enable>

Query Syntax: STATus:OPERation:ENABle?

Parameter: <enable> (0 ~ 32767)

Return parameter: <NR1>

Example:

STAT:OPER:ENAB 10

- The selected bits are then reported to the Status Byte. An enable register defines which bits in the event register will be reported to the Status Byte register group. You can write to or read from an enable register.
-

STATus:OPERation[:EVENT]?

Returns the total number of the Operation Event register.

Return parameter: <NR1>

Example:

STAT:OPER:EVEN?

Returns: +786

- An event register is a read-only register that latches events from the condition register. While an event bit is set, subsequent events corresponding to that bit are ignored.
 - Once a bit is set, it remains set until cleared by reading the event register or by sending *CLS (clear status).
-

STATus:PRESet

Clears all enable register bits in Alarm Register, Standard Operation Register, and Questionable Data Register.

Parameter: [None]

Example:

STAT:PRES

STATus:QUESTionable:CONDition?

Returns the total number of the Questionable Condition register.

Return parameter: <NR1> (0 ~ 32767)

Example:

STAT:QUES:COND?

Returns: +2

- A condition register continuously monitors the state of the instrument. Condition register bits are updated in real time; they are neither latched nor buffered.
-

STATus:QUEStionable:ENABle

Sets or returns bits in the Questionable Enable register.

Syntax: STATus:QUEStionable:ENABle <enable>

Query Syntax: STATus:QUEStionable:ENABle?

Parameter: <enable> (0 ~ 32767)

Return parameter: <NR1>

Example:

STAT:QUES:ENAB 4099

- The selected bits are then reported to the Status Byte. An enable register defines which bits in the event register will be reported to the Status Byte register group. You can write to or read from an enable register.
- The selected bits are then reported to the Status Byte. An enable register defines which bits in the event register will be reported to the Status Byte register group. You can write to or read from an enable register.
- A STATus:PRESet clears all bits in the enable register.
- The *PSC command controls whether the enable register is cleared at power on.

STATus:QUEStionable[:EVENT]?

Returns the total number of the Questionable Event register.

Return parameter: <NR1>

Example:

STAT:QUES:EVENT?

Returns: +6

- An event register is a read-only register that latches events from the condition register. While an event bit is set, subsequent events corresponding to that bit are ignored.
 - Once a bit is set, it remains set until cleared by reading the event register or by sending *CLS (clear status).
-

SYSTEM Related Commands

SYSTEM:ALARM?

Reads the alarm data from the alarm queue. A record of up to 20 alarms can be stored in the instrument's alarm queues.

Return parameter: <info>

Example:

SYST:ALAR?

Returns: +1.12379111E-03 VDC,2021,01,28,00,43,39.218,101,0,1

+1.12379111E-03 VDC,2021,01,28,00,43,39.218,101,0,1

1	2	3	4	5	6
---	---	---	---	---	---

1. Reading with units (1.124mV)
2. Date (January 28, 2021)
3. Time of day (0:43:39.218 AM)
4. Channel number
5. Alarm limit threshold crossed (0 = No alarm, 1 = LO, 2 = HI)
6. Alarm number (1-4)

- Each time you start a new scan, the instrument clears all readings (including alarm data) stored in reading memory from the previous measurement. Therefore, the contents of memory are always from the most recent scan.

SYSTEM:BEEP[[:IMMEDIATE]]

Makes buzzer beep once.

Parameter: [None]

Example:

SYST:BEEP:IMM

- This function is not affected by the state of SYST:BEEP:STAT.

SYSTem:BEEPer:ERRor

Enables (On) or disables (Off) the beeper to sound on an SCPI error.

Syntax: SYSTem:BEEPer:ERRor {OFF|ON}

Query Syntax: SYSTem:BEEPer:ERRor?

Parameter: 0 | 1 | OFF | ON

Return parameter: 0 | 1, (0 = OFF, 1 = ON)

Example:

SYST:BEEP:ERR ON

SYSTem:BEEPer:STATe

Enables (On) or disables (Off) the beep heard during measurements, or when an error is generated from the front panel or remote interface.

Syntax: SYSTem:BEEPer:STATe {OFF|ON}

Query Syntax: SYSTem:BEEPer:STATe?

Parameter: 0 | 1 | OFF | ON

Return parameter: 0 | 1, (0 = OFF, 1 = ON)

Example:

SYST:BEEP:STAT OFF

- The key sound of front panel is not affected by the state.
-

SYSTem:CLICk:STATe

Enables (On) or disables (Off) the click heard when knob is turned or keys are pressed.

Syntax: SYSTem:CLICk:STATe {OFF|ON}

Query Syntax:SYSTem:CLICk:STATe?

Parameter: 0 | 1 | OFF | ON

Return parameter: 0 | 1, (0 = OFF, 1 = ON)

Example:

SYST:CLIC:STAT OFF

SYSTem:CPON

Resets the module in the specified slot to its power-on state (CPON means "card power on"). This opens all channels on the module.

Syntax: SYSTem:CPON {<slot>|ALL}

Parameter: <slot> (1 | 2 | 3) | ALL

Example:

```
SYST:CPON? ALL
```

• If any channel is configured for a measurement, this command has no effect. If no channel is configured, this command opens all channels.

SYSTem:CTYPe?

Returns the identity of the plug-in modules in the specified slot.

Query Syntax: SYSTem:CTYPe? <slot>

Parameter: <slot> (1 | 2 | 3)

Returns parameter: <Company Name>,<Card Model Number>,<Serial Number>,<Firmware Rev>

Example:

```
SYST:CTYP? 1
```

```
Returns: GWInstek,DAQ-901,DAQ123456,1.00
```

SYSTem:DATE

Sets or returns the date for the instrument's real-time clock.

Syntax: SYSTem:DATE <year>,<month>,<day>

Query Syntax: SYSTem:DATE?

Parameter: <year> (2000 ~ 2099), <month> (1 ~ 12), <day> (1 ~ 31)

Return parameter: <date> (yyyy,mm,dd)

Example:

```
SYST:DATE 2020,1,1
```

```
SYST:DATE?
```

```
Returns: 2020,1,1
```

SYSTem:ERRor?

Returns the current system error, if any.

SYSTem:LFRequency?

Returns the AC source line frequency.

Return parameter: +50 | +60

SYSTem:LOCaI

Enables local control (front panel control) and disables remote control.

SYSTem:REMOte

Enables remote control and disables local control (front panel control, all key are disable besides Shift key(return to local control)).

SYSTem:PARAmeter:LOAD

Load the system parameters from 0 of 3 memory locations.

Syntax: SYSTem:PARAmeter:LOAD <mem_num>

Query Syntax: SYSTem:PARAmeter:LOAD?

Parameter: <mem_num> (0 ~ 3), (0 = default settings, 1 ~ 3 = memory number)

Return parameter: <NR1>, (Last = state before power-off)

Example:

SYST:PAR:LOAD 0

SYSTem:PARAmeter:SAVE

Saves the system parameters into 1 of 3 memory slots.

Syntax: SYSTem:PARAmeter:SAVE <mem_num>

Parameter: <mem_num> (1 ~ 3)

Example:

SYST:PAR:SAVE 1

SYSTem:PERSONa[:MANUfacturer]

Sets the instrument's manufacturer ID string for backward compatibility.

Syntax: SYSTem:PERSONa[:MANUfacturer] "<string>"

Query Syntax: SYSTem:PERSONa[:MANUfacturer]?

Parameter: "<string>", max length 24 characters

Return parameter: "<string>"

Example:

SYST:PERS "HEWLETT-PACKARD"

SYST:PERS?

Returns: "HEWLETT-PACKARD"

SYSTem:PERSONa[:MANufacturer]:DEFault

Sets or returns the default manufacturer's ID string.

Syntax: SYSTem:PERSONa[:MANufacturer]:DEFault

Query Syntax: SYSTem:PERSONa[:MANufacturer]:DEFault?

Parameter: [None]

Return parameter: "<string>"

Example:

SYST:PERS:DEF?

Returns: "Keysight Technologies"

SYSTem:PERSONa:MODEl

Sets the instrument's model number for backward compatibility.

Syntax: SYSTem:PERSONa:MODEl "<string>"

Query Syntax: SYSTem:PERSONa:MODEl?

Parameter: "<string>", max length 24 characters

Return parameter: "<string>"

Example:

SYST:PERS "34970A"

SYST:PERS?

Returns: "34970A"

SYSTem:PERSONa:MODEl:DEFault

Sets or returns the default instrument's model number.

Syntax: SYSTem:PERSONa:MODEl:DEFault

Query Syntax: SYSTem:PERSONa:MODEl: DEFault?

Parameter: [None]

Return parameter: "<string>"

Example:

SYST:PERS:MODE:DEF?

Returns: "DAQ970A"

SYSTem:PRESet

Presets the instrument to a known configuration. Readings are cleared, and channels are opened.

SYSTEM:RELay:CYCLes?

Reads the cycle count on the specified channels. In addition to the channel relays, you can also query the count on the Analog Bus relays and module relays.

Query Syntax: SYSTEM:RELay:CYCLes? (@<ch_list>)

Return parameter: <NR1>

Example:

SYST:REL:CYCL? (@101)

Returns: +100

SYSTEM:RELay:CYCLes:CLEar

Resets the cycle count on the specified channels.

Syntax: SYSTEM:RELay:CYCLes:CLEar (@<ch_list>)

Parameter: [None]

Example:

SYST:REL:CYCL:CLE (@101)

SYSTEM:RELay:CYCLes:FACTory?

Reads the factory cycle count on the specified channels.

Query Syntax: SYSTEM:RELay:CYCLes:FACTory? (@<ch_list>)

Return parameter: <NR1>

Example:

SYST:REL:CYCL:FACT? (@101)

Returns: +200

SYSTem:SCPi:MODE

Sets or returns the SCPI mode. The SCPI mode is used to determine whether the *IDN? query returns the "NORmal" or "COMPatible" identification string. See the SYSTem:IDNStr command for details.

Syntax: SYSTem:SCPi:MODE {NORmal|COMPatible}

Query Syntax: SYSTem:SCPi:MODE?

Parameter: NORmal | COMPatible, (NOR = Normal, COMP = User-define)

Return parameter: NORMAL | COMPATIBLE

Example:

```
SYST:SCP:MODE NOR
```

- The parameters will not be saved.
-

SYSTem:SCPi:AUTO:SAVE

Do the setting parameters need to be saved automatically for SCPI command?

Syntax: SYSTem:SCPi:AUTO:SAVE {OFF|ON}

Query Syntax: SYSTem:SCPi:AUTO:SAVE?

Parameter: 0 | 1 | OFF | ON

Return parameter: 0 | 1, (0 = OFF, 1 = ON)

Example:

```
SYST:SCP:AUTO:SAVE ON
```

- Parameters auto saving generally takes some time. Hence, it is suggested to disable the function when no necessity occurs.
-

SYSTem:SERial?

Returns the serial number(nine characters/numbers).

Return parameter: <string>

Example:

```
SYST:SER?
```

Returns: DAQ123456

SYSTem:SLOT:LABel

Allows you to add a custom label to the module in the specified slot.

Syntax: SYSTem:SLOT:LABel <slot>,"<string>"

Query Syntax: SYSTem:SLOT:LABel? <slot>

Parameter: <slot> (1 | 2 | 3); "<string>", max length 10 characters.

Return parameter: "<string>"

Example:

```
SYST:SLOT:LAB 1," BATTERY "
```

```
SYST:SLOT:LAB? 1
```

Returns: "BATTERY"

- Specifying a null string ("") disables the slot label message.
-

SYSTem:TEMPerature?

Returns the internal temperature of machine.

Return parameter: <NRf>, where unit = °C

Example:

```
SYST:TEMP?
```

Returns: +3.54375000E+01

SYSTem:TIME

Sets or returns the time for the instrument's real-time clock.

Syntax: SYSTem:TIME <hour>,<minute>,<second>

Query Syntax: SYSTem:TIME?

Parameter: <hour> (0 ~ 23); <minute> (0 ~ 59); <second> (0 ~ 59)

Return parameter: <time> (hh,mm,ss.sss)

Example:

```
SYST:TIME 16,20,30
```

```
SYST:TIME?
```

Returns: 16:20:40.000

SYSTem:TIME:SCAN?

Returns the time at the start of the scan.

Return parameter: <time> (yyyy,mm,dd,hh,mm,ss.sss)

Example:

```
SYST:TIME:SCAN?
```

Returns: 2021,09,08,20,21,22.001

SYSTem:UPTime?

Returns the amount of time that the instrument has been running since the last power-on.

Return parameter: <time> (dd, hh, mm, ss)

Example:

SYST:UPT?

Returns: +0,+1,+25,+53

- Typically used to verify that the instrument is warmed up sufficiently before calibration.
-

SYSTem:VERSion?

Returns the SCPI version.

Return parameter: 1994.0.

SYSTem:WMESsage

Displays a power-on message.

Syntax: SYSTem:WMESsage "<string>"

Query Syntax: SYSTem:WMESsage?

Parameter: "<string>", max length 12 characters

Return parameter: "<string>"

Example:

SYST:WMES "GW INSTEK"

SYST:WMES?

Returns: "GW INSTEK"

- Specifying a null string ("") disables the power-on message.
-

SYSTem COMMunication Commands

SYSTem:COMMunicate:GPIB:ADDRess

Sets or returns the GPIB address that is only on GPIB communication bus.

Syntax: SYSTem:COMMunicate:GPIB:ADDRess <address>

Query Syntax: SYSTem:COMMunicate:GPIB:ADDRess?

Parameter: <address> (0 ~ 30)

Return parameter: <NR1>

Example:

```
SYST:COMM:GPIB:ADDR 15
```

SYSTem:COMMunicate:LAN:DHCP

Enables (On) or disables (Off) the use of the Dynamic Host Configuration Protocol (DHCP) for the instrument.

Syntax: SYSTem:COMMunicate:LAN:DHCP {OFF|ON}

Query Syntax: SYSTem:COMMunicate:LAN:DHCP?

Parameter: 0 | 1 | OFF | ON

Return parameter: 0 | 1, (0 = OFF, 1 = ON)

Example:

```
SYST:COMM:LAN:DHCP ON
```

SYSTem:COMMunicate:LAN:DNS[X]

Sets or returns the DNS address. which X = 1 indicate DNS1, X = 2 indicate DNS2.

Syntax: SYSTem:COMMunicate:LAN:DNS[X] "<address>"

Query Syntax: SYSTem:COMMunicate:LAN:DNS[X]? {CURRent|STATic}

Parameter: "<address>"

Return parameter: "xxx.xxx.xxx.xxx"

CURRent : Returns address currently being used by the instrument.

STATic : Returns address from non-volatile memory. This address is used if DHCP is disabled or unavailable.

Example:

```
SYST:COMM:LAN:DNS1 "172.16.1.252"
```

```
SYST:COMM:LAN:DNS1?
```

Returns: "172.16.1.252"

SYSTem:COMMunicate:LAN:DOMain?

Returns the current network domain name.

Return parameter: "<name>"

Example:

SYST:COMM:LAN:DOM?

Returns: "abc.com"

- If a domain name has not been assigned, a null string (" ") is returned.
-

SYSTem:COMMunicate:LAN:GATeway

Sets or returns the Gateway address.

Syntax: SYSTem:COMMunicate:LAN:GATeway "<address>"

Query Syntax: SYSTem:COMMunicate:LAN:GATeway? {CURRent|STATic}

Parameter: "<address>"

Return parameter: "xxx.xxx.xxx.xxx"

CURRent : Returns address currently being used by the instrument.

STATic : Returns address from non-volatile memory. This address is used if DHCP is disabled or unavailable.

Example:

SYST:COMM:LAN:GAT "192.168.31.254"

SYST:COMM:LAN:GAT?

Returns: "172.168.31.254"

SYSTem:COMMunicate:LAN:HOSTname

Sets or returns the hostname.

Syntax: SYSTem:COMMunicate:LAN:HOSTname "<string>"

Query Syntax: SYSTem:COMMunicate:LAN:HOSTname? {CURRent|STATic}

Parameter: "<string>", max length 12 characters

Return parameter: "<string>"

CURRent : Returns hostname currently being used by the instrument.

STATic : Returns hostname from non-volatile memory. This address is used if DHCP is disabled or unavailable.

Example:

SYST:COMM:LAN:HOST "DMM"

SYSTem:COMMunicate:LAN:IPADdress

Sets or returns the IP address.

Syntax: SYSTem:COMMunicate:LAN:IPADdress "<address>"

Query Syntax: SYSTem:COMMunicate:LAN:IPADdress? {CURRent|STATic}

Parameter: "<address>"

Return parameter: "xxx.xxx.xxx.xxx"

CURRent : Returns address currently being used by the instrument.

STATic : Returns static address from non-volatile memory. This address is used if DHCP is disabled or unavailable.

Example:

```
SYST:COMM:LAN:IPAD "192.168.31.117"
```

```
SYST:COMM:LAN:IPAD?
```

Returns: "192.168.31.117"

SYSTem:COMMunicate:LAN:MAC?

Returns the MAC number.

Return parameter: 12 Hexadecimal characters

Example:

```
SYST:COMM:LAN:MAC?
```

Returns: "002224000090"

SYSTem:COMMunicate:LAN:SMASk

Sets or returns the subnet mask address.

Syntax: SYSTem:COMMunicate:LAN:SMASk "<address>"

Query Syntax: SYSTem:COMMunicate:LAN:SMASk? {CURRent|STATic}

Parameter: "<address>"

Return parameter: "xxx.xxx.xxx.xxx"

CURRent : Returns subnet mask currently being used by the instrument.

STATic : Returns subnet mask from non-volatile memory. This address is used if DHCP is disabled or unavailable.

Example:

```
SYST:COMM:LAN:SMAS "255.255.255.0"
```

```
SYST:COMM:LAN:SMAS?
```

Returns: "255.255.255.0"

SYSTem:COMMunicate:LAN:TCP:ENABLE

Enables (On) or disables (Off) the use of the Transmission Control Protocol (TCP) for the instrument.

Syntax: SYSTem:COMMunicate:LAN:TCP:ENABLE {OFF|ON}

Query Syntax: SYSTem:COMMunicate:LAN:TCP:ENABLE?

Parameter: 0 | 1 | ON | OFF

Return parameter: 0 | 1, (0 = OFF, 1 = ON)

Example:

SYST:COMM:LAN:TCP:ENAB ON

SYSTem:COMMunicate:LAN:TCP:PORT

Sets or returns the TCP communication port number.

Syntax: SYSTem:COMMunicate:LAN:TCP:PORT {<port>|MIN|MAX|DEF}

Query Syntax: SYSTem:COMMunicate:LAN:TCP:PORT? [{MIN|MAX|DEF}]

Parameter: <port> (1024 ~ 65535); DEF: 5025

Return parameter: <NR1>

Example:

SYST:COMM:LAN:TCP:PORT "5025"

SYST:COMM:LAN:TCP:PORT?

Returns: 5025

SYSTem:COMMunicate:LAN:TELNet:ECHO

Sets or returns the Telnet communication echo state.

Syntax: SYSTem:COMMunicate:LAN:TELNet:ECHO {OFF|ON}

Query Syntax: SYSTem:COMMunicate:LAN:TELNet:ECHO?

Parameter: 0 | 1 | ON | OFF

Return parameter: 0 | 1, (0 = OFF, 1 = ON)

Example:

SYST:COMM:LAN:TELN:ECHO ON

SYSTem:COMMunicate:LAN:TELNet:ENABle

Enables (On) or disables (Off) the use of the Telecommunications Network (TELNET) for the instrument.

Syntax: SYSTem:COMMunicate:LAN:TELNet:ENABle {OFF|ON}

Query Syntax: SYSTem:COMMunicate:LAN:TELNet:ENABle?

Parameter: 0 | 1 | ON | OFF

Return parameter: 0 | 1, (0 = OFF, 1 = ON)

Example:

SYST:COMM:LAN:TELN:ENAB ON

SYSTem:COMMunicate:LAN:TELNet:TIMeout

Sets or returns the Telnet communication timeout time, where unit = second.

Syntax: SYSTem:COMMunicate:LAN:TELNet:TIMeout <time>

Query Syntax: SYSTem:COMMunicate:LAN:TELNet:TIMeout?

Parameter: <time> (0 ~ 60000)

Return parameter: <NR1>

Example:

SYST:COMM:LAN:TELN:TIM 0

- Since 0 indicates infinite, Telnet communication has no timeout always.
-

SYSTem:COMMunicate:LAN:TELNet:PORT

Sets or returns the Telnet communication port number.

Syntax: SYSTem:COMMunicate:LAN:TELNet:PORT {<port>|MIN|MAX|DEF}

Query Syntax: SYSTem:COMMunicate:LAN:TELNet:PORT?

[{MIN|MAX|DEF}]

Parameter: <port> (1024 ~ 65535); DEF: 5024

Return parameter: <NR1>

Example:

SYST:COMM:LAN:TELN:PORT "5024"

SYST:COMM:LAN:TELN:PORT?

Returns: 5024

SYSTem:COMMunicate:LAN:TELNet:PROMpt

Sets or returns the telnet prompt message.

Syntax: SYSTem:COMMunicate:LAN:TELNet:PROMpt "<string>"

Query Syntax: SYSTem:COMMunicate:LAN:TELNet:PROMpt?

Parameter: "<string>", max length 15 characters

Return parameter: "<string>"

Example:

```
SYST:COMM:LAN:TELN:PROM "DAQ9600>"
```

```
SYST:COMM:LAN:TELN:PROM?
```

Returns: DAQ9600>

SYSTem:COMMunicate:LAN:TELNet:WMESsage

Sets or returns the telnet welcome message that telnet communication connect success.

Syntax: SYSTem:COMMunicate:LAN:TELNet:WMESsage "<string>"

Query Syntax: SYSTem:COMMunicate:LAN:TELNet:WMESsage?

Parameter: "<string>", max length 63 characters

Return parameter: "<string>"

Example:

```
SYST:COMM:LAN:TELN:WMES "Welcome to DAQ9600 Telnet Server"
```

SYSTem:COMMunicate:LAN:TIMEout

Sets or returns the TCP communication timeout time, where unit = second.

Syntax: SYSTem:COMMunicate:LAN:TIMEout <time>

Query Syntax: SYSTem:COMMunicate:LAN:TIMEout?

Parameter: <time> (1 ~ 60000)

Return parameter: <NR1>

Example:

```
SYST:COMM:LAN:TIM 10
```

SYSTem:COMMunicate:LAN:UPDate

Stores any changes made to the LAN settings into non-volatile memory and restarts the LAN driver with the updated settings.

Parameter: [None]

Example:

```
SYST:COMM:LAN:UPD
```

• This command must be sent after changing the settings for DHCP, DNS, gateway, hostname, IP address, subnet, mask, or WINS.

SYSTem:COMMunicate:LAN:WEB:ENABLE

Enables (On) or disables (Off) the use of the WEB page for the instrument.

Syntax: SYSTem:COMMunicate:LAN:WEB:ENABLE {OFF|ON}

Query Syntax: SYSTem:COMMunicate:LAN:WEB:ENABLE?

Parameter: 0 | 1 | ON | OFF

Return parameter: 0 | 1, (0 = OFF, 1 = ON)

Example:

```
SYST:COMM:LAN:WEB:ENAB ON
```

SYSTem:COMMunicate:LAN:WINS

Assigns the static IP addresses of the Windows Internet Name System (WINS) servers.

Syntax: SYSTem:COMMunicate:LAN:WINS "<address>"

Query Syntax: SYSTem:COMMunicate:LAN:WINS? {CURRent|STATic}

Parameter: "<address>"

Return parameter: "xxx.xxx.xxx.xxx"

CURRent : Returns address currently being used by the instrument.

STATic : Returns address from non-volatile memory. This address is used if DHCP is disabled or unavailable.

Example:

```
SYST:COMM:LAN:WINS "192.168.31.117"
```

```
SYST:COMM:LAN:WINS?
```

Returns: "192.168.31.117"

TRIGger Commands

TRIGger:COUNt

Sets or returns the number of trigger counts.

Syntax: TRIGger:COUNt {<count>|MIN|MAX|DEF|INFINITY}

Query Syntax: TRIGger:COUNt? [{MIN|MAX|DEF}]

Parameter: <count> (1 ~ 1,000,000); DEF: 1

Return parameter: <NRf>

Example:

```
CONF:VOLT:DC 10(@101,103)
ROUT:SCAN (@101,103)
TRIG:COUN 2
READ?
```

● For a continuous trigger (INFINITY), the query returns "+9.90000000E+37".

TRIGger:SLOPe

Selects whether the instrument uses the rising edge (POS) or the falling edge (NEG) of the trigger signal on the rear-panel Digital I/O connector when external trigger is selected.

Syntax: TRIGger:SLOPe {POSitive | NEGative}

Query Syntax: TRIGger:SLOPe?

Parameter: POSitive | NEGative

Return parameter: POS | NEG

Example:

```
TRIG:SLOP POS
```

TRIGger:SOURce

Selects or returns current trigger source.

Syntax: TRIGger:SOURce <source>

Query Syntax: TRIGger:SOURce?

Parameter: <source> (IMMEDIATE | EXTERNAL | BUS | TIMER | ALARM{(1|2|3|4)})

Return parameter: IMM | EXT | BUS | TIM | ALAR{(1|2|3|4)}

IMMEDIATE = Continuous scan trigger

EXTERNAL = An external TTL-compatible pulse trigger

BUS = Software trigger

TIMER = Internally paced timer trigger

ALARm = Trigger on alarm 1,2,3, and 4

IMMEDIATE:

The trigger signal is always present. When you place the instrument in the "wait-for-trigger" state, the trigger is issued immediately.

Example:

```
TRIG:SOUR IMM
READ?
```

EXTERNAL:

The instrument accepts hardware triggers applied to the rear-panel Ext Trig input and takes the specified number of measurements, each time a TTL pulse specified by TRIGg:SLOP is received. If the instrument receives an external trigger before it is ready, it buffers one trigger.

Example:

```
TRIG:SOUR EXT
INIT
<wait external trigger in signal>
FETC ?
```

BUS:

The instrument is triggered by *TRG over the remote interface once the DMM is in the "wait-for-trigger" state.

Example:

```
TRIG:SOUR BUS
INIT
*TRG
FETC ?
```

- After selecting the trigger source, you must place the instrument in the "wait-for-trigger" state using the INITiate or READ? command. A trigger will not be accepted from the selected trigger source until the instrument is in the "wait-for-trigger" state.

TRIGger:TIMer

Sets the trigger-to-trigger interval (in seconds) for measurements on the channels in the present scan list.

Syntax: TRIGger:TIMer {<seconds>|MIN|MAX|DEF}

Query Syntax: TRIGger:TIMer? [{MIN|MAX|DEF}]

Parameter: <second> (0 ~ 360,000s); DEF: 10

Return parameter: <NR1>

Example:

```
TRIG:SOUR TIM
```

```
TRIG:TIM: 3600
```

- This command defines the time from the start of one trigger to the start of the next trigger, up to the specified trigger count.
 - If the scan interval is less than the time required to measure all channels in the scan list, the instrument will scan continuously, as fast as possible (no error is generated).
-

IEEE 488.2 Common Commands

*CLS

Clears the Event Status register (Output Queue, Operation Event Status, Questionable Event Status, Standard Event Status Register)

*ESE

Sets or returns the ESER (Event Status Enable Register) contents.

Syntax: *ESE <enable>

Query Syntax: *ESE?

Parameter: <enable> (0 ~ 255)

Return parameter: <NR1>

Example:

*ESE 130

*ESE?

Returns: 130. ESER=10000010

- The selected bits are then reported to bit 5 of the Status Byte Register. An enable register defines which bits in the event register will be reported to the Status Byte register group. You can write to Or read from an enable register.

*ESR?

Returns SESR (Standard Event Status Register) contents.

Return parameter: <NR1>

Example:

*ESR?

Returns: 198. SESR=11000110

- An event register is a read-only register that latches events from the condition register. While an event bit is set, subsequent events corresponding to that bit are ignored.

- Once a bit is set, it remains set until cleared by reading the event register or by sending *CLS (clear status).

***IDN?**

Returns the manufacturer, model No., serial number and system version number.

Example:

*IDN?

Returns: GWInstek,DAQ-9600,000000000,M0.93_S0.86

***OPC**

Sets operation complete bit (bit0) in SERS (Standard Event Status Register) when all pending operations are completed.

Returns 1 to the output buffer after all pending commands complete. Other commands cannot be executed until this command completes.

Syntax: *OPC

Query Syntax: *OPC?

Parameter: [None]

Return parameter: 1;(operation completes)

Example:

CONF:VOLT:DC

TRIG:COUN 10

INIT

*OPC?

●The difference between *OPC and *OPC? is that*OPC sets a status bit when the operation completes,and *OPC? outputs "1" when the operation completes.

***PSC**

Clears or returns the Power On status.

Syntax: *PSC {0|1}

Query Syntax: *PSC?

Parameter: 0 | 1

Return parameter: 0 | 1; (0= disables, 1= enables)

- Enables (1) or disables (0) the clearing of certain enable registers at power on:

Questionable Data Register (STATus:OPERation:ENABLE)

Standard Operation Register (STATus:QUEStionable:ENABLE)

Alarm Register (STATus:ALARm:ENABLE)

Status Byte Condition Register (*SRE)

Standard Event Enable Register (*ESE)

- The *PSC command does not affect the clearing of the condition or event registers, just the enable registers.
-

***RCL**

Load the system parameters from 0 of 3 memory locations.

Syntax: *RCL <mem_num>

Parameter: <mem_num> (0 ~ 3), (0=default settings, 1 ~ 3= memory number)

Example:

*RCL 1

***RST**

Recalls default panel setup.

- Resets instrument to factory default state. This is similar to SYSTem:PRESet. The difference is that *RST resets the instrument for SCPI operation, and SYSTem:PRESet resets the instrument for front panel operation. As a result, *RST turns the histogram and statistics off, and SYSTem:PRESet turns them on.
-

***SAV**

Save the system parameters to 1 of 3 memory locations.

Syntax: *SAV <mem_num>

Parameter: <mem_num> (1 ~ 3)

Example:

*SAV 2

***SRE**

Sets or returns the SRER (Service Request Enable Register) contents.

Syntax: *SRE <enable>

Query Syntax: *SRE?

Parameter: <enable> (0 ~ 255)

Return parameter: <NR1>

Example:

*SRE 7

*SRE?

Returns: 7. SRE=00000111

●An enable register defines which bits in the event register will be reported to the Status Byte register group. You can write to or read from an enable register.

***STB?**

Returns the SBR (Status Byte Register) contents.

Return parameter: <NR1>

Example:

*STB?

Returns: 81. SBR=01010001.

●A condition register continuously monitors the state of the instrument. Condition register bits are updated in real time; they are neither latched nor buffered.

●This register is read-only; bits are not cleared when read.

***TRG**

Manually triggers the DAQ-9600 if TRIG:SOUR is selected to BUS.

Example:

```
TRIG:SOUR BUS
INIT
*TRG
FETC?
```

***TST?**

Runs a standard self-test which is invoked at power-on. It will take few seconds to complete.

Return parameter: 0 | 1; (0 = pass, 1 = one or more tests failed)

Example:

```
*TST?
Returns: +0.
```

***WAI**

Configures the instrument's output buffer to wait for all pending operations to complete before executing any additional commands over the interface.

Status system

The diagram below is a description of the status system

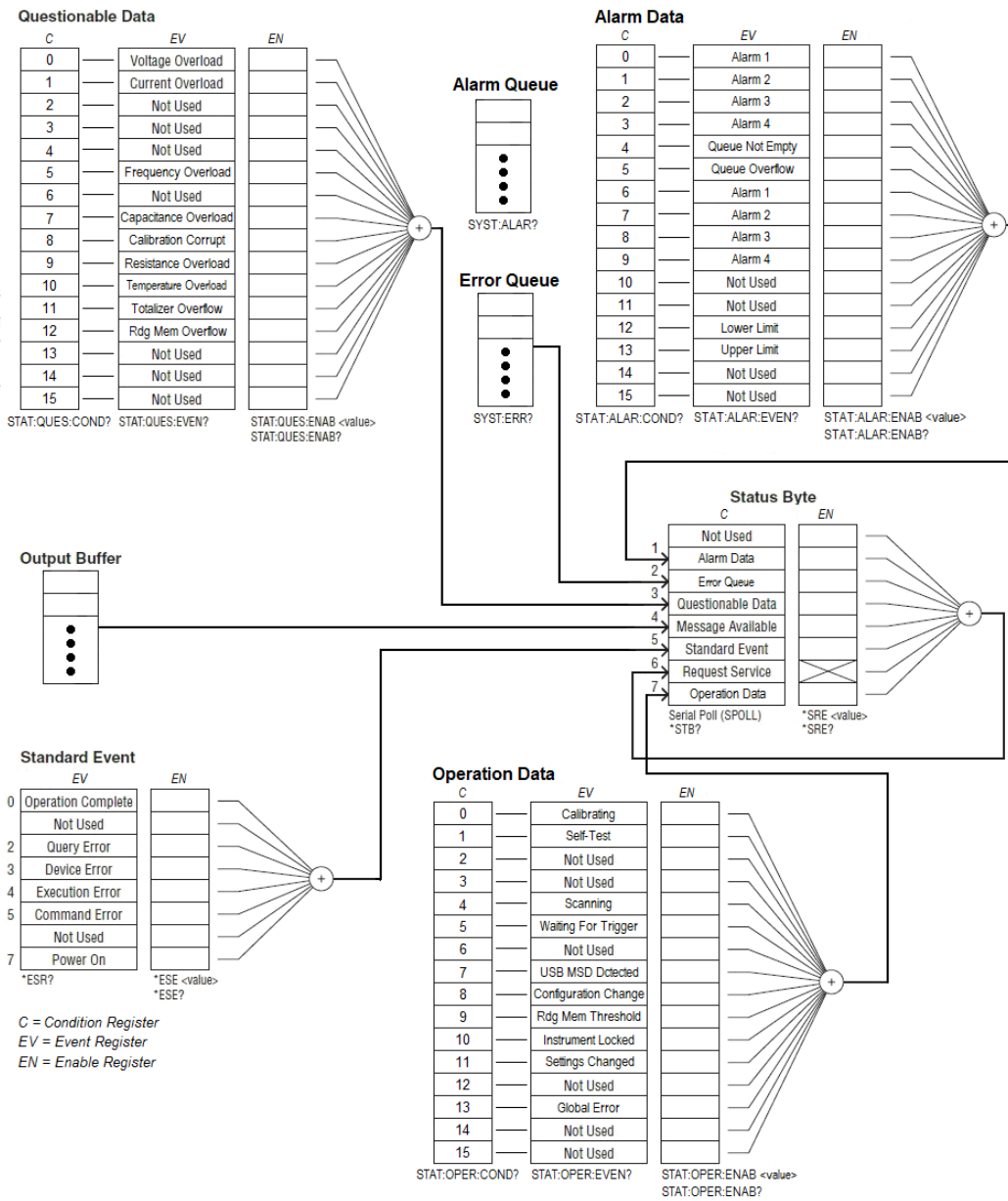

NOTE: The overload bits are set once per INITiate command. If you clear an overload bit, it is not set again until a new INITiate is sent.

The following table lists the bit definitions for the Questionable Data Register:

Bit	Name	Decimal	Definition
0	Voltage Overload	1	A voltage measurement overloaded. Event only; condition register will return 0.
1	Current Overload	2	A current measurement overloaded. Event only; condition register will return 0.
2	Not Used	4	(Reserved for future use)
3	Not Used	8	(Reserved for future use)
4	Not Used	16	(Reserved for future use)
5	Frequency Overload / Underflow	32	A frequency or period measurement overloaded or timed out due to no signal. Event only; condition register will return 0
6	Not Used	64	(Reserved for future use)
7	Capacitance Overload	128	A capacitance measurement overloaded. Event only; condition register will return 0.
8	Calibration Corrupt	256	At least one calibration constant is corrupt.
9	Resistance Overload	512	Only reported as event. In Condition Register this bit always returns 0. Read the Event Register.
10	Temperature Overload	1024	A temperature measurement overloaded. Event only; condition register will return 0.
11	Totalizer Overflow	2048	The most recent measurement failed the lower limit test.
12	Reading Memory Overflow	4096	Reading memory is full. One or more (oldest) measurements have been lost.
13	Not Used	8192	(Reserved for future use)
14	Not Used	16384	(Reserved for future use)
15	Not Used	32768	(Reserved for future use)

The following table lists the bit definitions for the Operation Data Register:

Bit	Name	Decimal	Definition
0	Calibrating	1	Instrument is performing a calibration.
1	Self Test	2	The instrument is doing a self-test.
2	Not Used	4	(Reserved for future use)

3	Not Used	8	(Reserved for future use)
4	Scanning	16	The instrument is scanning.
5	Waiting For Trigger	32	Instrument is waiting for a trigger.
6	Not Used	64	(Reserved for future use)
7	USB MSD detected	128	A USB mass storage device (USB drive) has been detected.
8	Configuration Change	256	The instrument configuration has changed via front panel since the last INIT, READ? or MEASure?.
9	Reading Memory Threshold	512	The number of readings in memory has exceeded the memory threshold setting (DATA:POINts:EVENT:THReshold command)
10	Instrument Locked	1024	The instrument is locked (SYSTem:LOCK command)
11	Settings Changed	2048	The instrument configuration has changed via front panel or SCPI since the last INIT, READ? Or MEASure?. Event only, condition register returns 0.
12	Not Used	4096	(Reserved for future use)
13	Global Error	8192	An error is in the global error queue.
14	Not Used	16384	(Reserved for future use)
15	Not Used	32768	(Reserved for future use)

The following table lists the bit definitions for the Alarm Data Register:

Bit	Name	Decimal	Definition
0	Alarm 1	1	An event has occurred on Alarm 1. Event only; condition register will return 0.
1	Alarm 2	2	An event has occurred on Alarm 2. Event only; condition register will return 0.
2	Alarm 3	4	An event has occurred on Alarm 3. Event only; condition register will return 0.
3	Alarm 4	8	An event has occurred on Alarm 4. Event only; condition register will return 0.
4	Queue Not Empty	16	The alarm queue is not empty.
5	Queue Overflow	32	An alarm queue overflowed. Event only; condition register will return 0.
6	Alarm 1	64	Alarm 1 is triggered.
7	Alarm 2	128	Alarm 2 is triggered.
8	Alarm 3	256	Alarm 3 is triggered.

9	Alarm 4	512	Alarm 4 is triggered.
10	Not Used	1024	(Reserved for future use)
11	Not Used	2048	(Reserved for future use).
12	Lower Limit	4096	A lower limit alarm has occurred.
13	Upper Limit	8192	An upper limit alarm has occurred.
14	Not Used	16384	(Reserved for future use)
15	Not Used	32768	(Reserved for future use)

The following table describes the Standard Event Register

Bit	Name	Decimal	Definition
0	Operation Complete	1	All commands prior to and including *OPC have been executed.
1	Not Used	2	(Reserved for future use)
2	Query Error	4	The instrument tried to read the output buffer but it was empty. Or, a new command line was received before a previous query has been read. Or, both the input and output buffers are full.
3	Device Error	8	A device error, including a self-test error or calibration error, occurred (an error in the -300 range or any positive error has been generated).
4	Execution Error	16	An execution error occurred (an error in the -200 range has been generated).
5	Command Error	32	A command syntax error occurred (an error in the -100 range has been generated).
6	Not Used	64	(Reserved for future use)
7	Power On	128	Power has been cycled since the last time the event register was read or cleared.

The following table describes the Status Byte Register.

Bit	Name	Decimal	Definition
0	Not Used	1	(Reserved for future use)
1	Alarm Data	2	One or more bits are set in the Alarm Enable Register. (bits must be enabled, see STATus:ALARm:ENABLE command.)
2	Error Queue	4	One or more errors have been stored in the Error Queue. Use SYST:ERR? to read and delete errors.
3	Questionabl	8	One or more bits are set in the Questionable Data

	e Data		Register (bits must be enabled, see STAT:QUES:ENAB).
4	Message Available	16	Data is available in the instrument's output buffer.
5	Standard Event	32	One or more bits are set in the Standard Event Register (bits must be enabled, see *ESE).
6	Request Service	64	One or more bits are set in the Status Byte Register and may generate a Request for Service(RQS). Bits must be enabled using *SRE.
7	Operation Data	128	One or more bits are set in the Standard Operation Register (bits must be enabled, see STAT:OPER:ENAB).

APPENDIX

Fuse Replacement	343
Battery Replacement	344
Factory Default Parameters	346
Specifications.....	348
General	348
DAQ-9600 Section	349
DC Characteristics ^[1]	349
AC Characteristics ^[1]	353
Frequency and Period Characteristics	357
Temperature Characteristics ^[1]	358
Capacitance	359
Dimensions – DAQ-9600	362
Dimensions – Module	363
Declaration of Conformity	364

Fuse Replacement

Steps 1. Unplug power cord and place dual flat-blade drivers into the grooves of fuse socket sideways followed by pinching together to pull out the fuse socket.

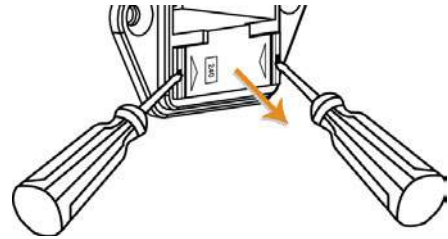

2. The fuse socket appears. The “240” symbol within the hole on fuse socket indicates the line voltage is positioned as 240V.

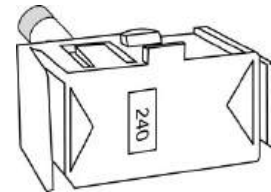

3. Pull the fuse holder out of the fuse socket gently as the right figure illustrates.

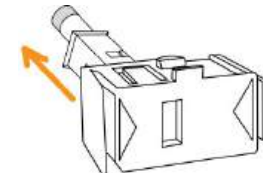

4. Further pull the fuse out of the fuse holder and replace it with a new fuse.

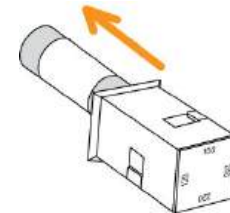

5. Restore the fuse holder with new fuse back to the fuse socket. Ensure that the correct line voltage shows within the hole of the fuse socket per requirement.

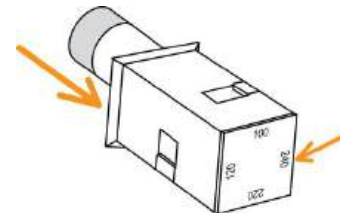

	Type of fuse (time-lag)	Input line voltage
Rating	T0.125A, 250V, 5x20mm	100/120VAC
	T0.125A, 250V, 5x20mm	220/240VAC
Replace Module Internal Current Fuse	DAQ-901 F1.6A, 300V , 5*20mm	breaking capacity:3KA
	DAQ-909 F2.5A, 600V , 6*30mm	breaking capacity:6KA

Battery Replacement

Beforehand

This chapter describes the procedure of battery replacement in the front panel. Before start, it is required to let a certified and trained technician properly aware of potential risks to disassemble instrument case. Some of the electrical connections are dynamic and even available after powering off the instrument. Consequently, Do disconnect all the inputs, cords and cables before disassembling the instrument.

The steps to replace battery

1. Power off properly and disconnect all the cables including power cord and those for external interfaces. Also, uninstall the modules from the slots of the instrument.
 2. Disassemble the instrument case in light of the disassembling instructions.
 3. Find the battery (CR2032) on the main board as shown from the figure below.
-



4. Gently remove the battery via the end tip of flat-head screwdriver as the following figure shown.



5. Use fingers to take the battery out off the compartment with ease.





6. Dispose or recycle the used battery in accord with the applicable local regulations.

7. Place a new battery (CR2032) into the compartment and beware of the polarity (+, -). Put “+” side upwards. Gently press the battery downwards to click it into place.



8. Connect every cable and cord in need and reassemble the instrument in proper order. The procedure of battery replacement is completed.

Factory Default Parameters

Channel			
Item List	Factory Default Parameter	Parameter Save/Load for Group 1 - 3	
Slot1	None	✓	
Slot2	None	✓	
Slot3	None	✓	
Measure	Off	✓	
Switch	Off	✓	
JoinBank	Off	✓	
Interval			
Item List	Factory Default Parameter	Parameter Save/Load for Group 1 - 3	
TrigSource	Auto	✓	
Sweep	1	✓	
Sweeps INF	Off	✓	
Signal Out	Negative	✓	
Log			
Item List	Factory Default Parameter	Parameter Save/Load for Group 1 - 5	
Log PARA	Capture	✓	
Filename	Default	✓	
Name	Time	✓	

Menu			
Item List		Factory Default Parameter	Parameter Save/Load for Group 1 - 5
System	Beep	On	✓
	Key Sound	On	✓
	Time Sync	Open	✗
Display	Brightness	60%	✓
	AutoOff	OFF	✓
	AutoOff Time	30min	✓
	1ST Font Color	White	✓
	Math Font Color	White	✓
	Math Off Display Mode	Off	✓
	Antialiasing	Off	✓
	Additional Info	Open	✓
	Language	English	✗
	Interface	Interface	USB
USB Protocol		USBCDC	✗
GPIB Address		15	✗
Identity		Default	✗
Lan	DHCP	ON	✗
	Web	ON	✗
	Telnet	ON	✗
	Telnet Port	5024	✗
	Telnet Echo	ON	✗
	TCP	ON	✗
	TCP Port	5025	✗



Only utilized parameters are listed here due to over-amount parameters. The rest of the parameters unlisted, however, can be saved and loaded as well.



It indicates parameters can be saved and loaded from the groups 1 to 5.



It indicates the independent save zone which is free from impact of reboot.

Specifications

General

This section lists the general characteristics of the instrument.

 Note	<ul style="list-style-type: none"> All specifications are ensured only under a single display. At least 1 hour of warm-up time is required before applying these specifications. MAX measuring voltage DC600V, AC400V.
Line Power	<ul style="list-style-type: none"> Power Supply: 100 / 120 / 220 / 240 VAC $\pm 10\%$ Power Line Frequency: 50 Hz / 60 Hz $\pm 10\%$ Power Consumption: Max. 50 VA
Environment	<ul style="list-style-type: none"> Operating Environment: Full accuracy for 0 °C to 55 °C Full accuracy to 80% R.H. at 40 °C Non-condensing Operating Altitude Up to 2,000 m Storage Temperature -40 to 70 °C
Mechanical	<ul style="list-style-type: none"> Rack Dimensions: 88mm(H) X 220mm(W) X348.6mm(D) (without bumpers) Bench Dimensions: 107mm(H) X 266.9mm(W) X357.8mm(D) (with bumpers) Weight : 4.5 kg (9.92lbs)
Display	<ul style="list-style-type: none"> 4.3" color WQVGA (480x272) with LED backlight Supports basic number, bar meter, trend chart and histogram views
Temperature Coefficient	<ul style="list-style-type: none"> Increment of one coefficient per one degree Celsius when the range is beyond TCAL ± 5 °C.
Accuracy Specification	<ul style="list-style-type: none"> It is relevant to the calibration standard.
Real-Time Clock/Calendar	<ul style="list-style-type: none"> Set and read, year, month, day, hour, minute, seconds Battery CR-2032 coin-type, replaceable

DAQ-9600 Section

DC Characteristics ^[1]

DC Voltage

Range ^[2]	24 Hour TCAL ± 1 °C	90 Day TCAL ± 5 °C	1 Year TCAL ± 5 °C	Temperature Coefficient/°C
100.0000 mV	0.0030 + 0.0050	0.0040 + 0.0060	0.0050 + 0.0060	0.0005 + 0.0005
1.000000 V	0.0020 + 0.0006	0.0035 + 0.0007	0.0048 + 0.0007	0.0005 + 0.0001
10.00000 V	0.0015 + 0.0004	0.0020 + 0.0005	0.0035 + 0.0005	0.0005 + 0.0001
100.0000 V	0.0020 + 0.0006	0.0035 + 0.0006	0.0050 + 0.0006	0.0005 + 0.0001
600.000 V	0.0025 + 0.0020	0.0040 + 0.0020	0.0050 + 0.0020	0.0005 + 0.0001

Accuracy Specifications: ± (% of reading + % of range)

Resistance ^[3]

Range ^[2]	Test Current	24 Hour TCAL ± 1 °C	90 Day TCAL ± 5 °C	1 Year TCAL ± 5 °C	Temperature Coefficient/°C
100.0000 Ω	1 mA	0.003 + 0.0030	0.008 + 0.004	0.010 + 0.004	0.0008 + 0.0005
1.000000 kΩ	1 mA	0.002 + 0.0005	0.008 + 0.001	0.010 + 0.001	0.0008 + 0.0001
10.00000 kΩ	100 μA	0.002 + 0.0005	0.008 + 0.001	0.010 + 0.001	0.0008 + 0.0001
100.0000 kΩ	10 μA	0.002 + 0.0005	0.008 + 0.001	0.010 + 0.001	0.0008 + 0.0001
1.000000 MΩ	5 μA	0.002 + 0.0010	0.008 + 0.001	0.010 + 0.001	0.0010 + 0.0002
10.00000 MΩ	500 nA	0.015 + 0.0010	0.020 + 0.001	0.040 + 0.001	0.0030 + 0.0004
100.0000 MΩ	500 nA//0.300 + 0.0100 10 MΩ		0.800 + 0.010	0.800 + 0.010	0.1500 + 0.0004
1.000000 GΩ	500 nA//2.50 + 0.0500 10 MΩ		3.50 + 0.0500	3.50 + 0.0500	1.0000 + 0.0040

Accuracy Specifications: ± (% of reading + % of range)

DC Current

Range ^[2]	Burden Voltage	24 Hour TCAL ± 1 °C	90 Day TCAL ± 5 °C	1 Year TCAL ± 5 °C	Temperature Coefficient/°C
Characteristics - typical: DC current					
1.000000 μA	< 0.015 V	0.025 + 0.050	0.050 + 0.050	0.050 + 0.050	0.002 + 0.003
10.00000 μA	< 0.15 V	0.020 + 0.010	0.040 + 0.025	0.050 + 0.025	0.002 + 0.003
100.0000 μA	< 0.020 V	0.010 + 0.020	0.040 + 0.025	0.050 + 0.025	0.002 + 0.003
Specifications: DC current					
1.000000 mA	< 0.20 V	0.007 + 0.006	0.030 + 0.006	0.050 + 0.006	0.002 + 0.001
10.00000 mA	< 0.15 V	0.007 + 0.020	0.030 + 0.020	0.050 + 0.020	0.002 + 0.002
100.0000 mA	< 0.7 V	0.010 + 0.004	0.030 + 0.005	0.050 + 0.005	0.002 + 0.001
2.000000 A	< 0.8V	0.180 + 0.020	0.200 + 0.020	0.200 + 0.020	0.005 + 0.001

Accuracy Specifications: ± (% of reading + % of range)

Diode Test ^[4]

Range ^[2]	24 Hour TCAL ± 1 °C	90 Day TCAL ± 5 °C	1 Year TCAL ± 5 °C	Temperature Coefficient/°C
5 V	0.002 + 0.030	0.008 + 0.030	0.01 + 0.03	0.001 + 0.002

Accuracy Specifications: \pm (% of reading + % of range)

Measuring Characteristics

DC Voltage	Input Resistance	Range
		100 mV
		1 V
		10 V
		100 V
		600 V
	Input Bias	<30 pA (Typ, 25°C)
	Input Protection	600 V on all ranges

Measurement Method: Sigma-delta A/D Converter

Resistance	Max. Lead Resistance	10% of range per lead for 100 Ω, 1 kΩ ranges. 1 kΩ per lead on all other ranges.
	Input Protection	600 V on all ranges

Measurement Method: Selectable 4-wire or 2-wire ohms.

DC Current	Range	Shunt	Burden Voltage
	1 μA	10kΩ	<0.015 V
	10 μA	10kΩ	<0.15 V
	100 μA	100 Ω	<0.020 V
	1 mA	100 Ω	<0.20 V
	10 mA	10 Ω	<0.15 V
	100 mA	1 Ω	<0.7 V
	2 A	0.1 Ω	<0.8 V
	Input Protection	Internal 2 A, 250V fuse_T for 2 A	

Reading Rate (Readings/sec)		Speed	Digits
	DCV	5 /s , 20 /s , 60 /s , 100 /s	6 ½
		400 /s , 1.2 k /s , 2.4 k /s	5 ½
	DCI	4.8 k /s , 7.5 k /s , 14.4k ,	4 ¼
		19.2k , 38.4k	
	2W/4W-Resistance	Speed	Digits
Diode		400 /s	5 ½
			4 ¼

[1]. DC Specification: In addition to the availability that requires warm-up of 60 minutes, it must be set in 5/s speed rate, A-Zero on.

[2]. The entire range of measurement will pass the set range by 20% except the tests of 600 V DC, 2 A DC and diode.

[3]. This specifications applies to 4-wire ohms function or 2-wire ohms using math null for offset. Without math null, add 2 Ω additional error

in 2-wire ohms function. The 100M and 1G ohm ranges are 2-wire only.
[4]. This specification applies to the voltage measured from input terminal.
1 mA test current is the typical value. The change of current source
leads to the variation in buck of diode junction.

AC Characteristics ^[1]

True RMS AC Voltage ^{[2] [3] [4]}

Range ^[2]	Frequency	24 Hour TCAL ± 1 °C	90 Day TCAL ± 5 °C	1 Year TCAL ± 5 °C	Temperature Coefficient/°C
100 mV	3 Hz - 5 Hz	1.00 + 0.03	1.00 + 0.04	1.00 + 0.04	0.100 + 0.004
	5 Hz - 10 Hz	0.35 + 0.03	0.35 + 0.04	0.35 + 0.04	0.035 + 0.004
	10 Hz - 20 kHz	0.04 + 0.03	0.05 + 0.04	0.06 + 0.04	0.005 + 0.003
	20 kHz - 50 kHz	0.10 + 0.05	0.11 + 0.05	0.12 + 0.05	0.011 + 0.005
	50 kHz - 100 kHz	0.55 + 0.08	0.60 + 0.08	0.60 + 0.08	0.060 + 0.008
	100 kHz - 300 kHz	4.00 + 0.50	4.00 + 0.50	4.00 + 0.50	0.200 + 0.020
1 V ~ 400 V	3 Hz - 5 Hz	1.00 + 0.02	1.00 + 0.03	1.00 + 0.03	0.100 + 0.004
	5 Hz - 10 Hz	0.35 + 0.02	0.35 + 0.03	0.35 + 0.03	0.035 + 0.004
	10 Hz - 20 kHz	0.04 + 0.02	0.05 + 0.03	0.06 + 0.03	0.005 + 0.003
	20 kHz - 50 kHz	0.10 + 0.04	0.11 + 0.05	0.12 + 0.05	0.011 + 0.005
	50 kHz - 100 kHz	0.55 + 0.08	0.60 + 0.08	0.60 + 0.08	0.060 + 0.008
	100 kHz - 300 kHz	4.00 + 0.50	4.00 + 0.50	4.00 + 0.50	0.200 + 0.020

Accuracy Specifications: ± (% of reading + % of range)

True RMS AC Current ^{[2] [4] [5]}

Range ^[2]	Burden Voltage	Frequency	24 Hour TCAL ± 1 °C	90 Day TCAL ± 5 °C	1 Year TCAL ± 5 °C	Temperature Coefficient/°C
100 μA	< 0.020 V,	3 Hz – 5 Hz	1.00 + 0.04	1.00 + 0.06	1.00 + 0.06	0.100 + 0.006
		5 Hz – 10 Hz	0.35 + 0.04	0.35 + 0.06	0.35 + 0.06	0.035 + 0.006
		10 Hz – 5 kHz	0.10 + 0.04	0.10 + 0.06	0.10 + 0.06	0.015 + 0.006
		5 kHz – 10 kHz	0.18 + 0.04	0.18 + 0.10	0.18 + 0.10	0.035 + 0.006
1 mA	< 0.20 V,	3 Hz – 5 Hz	1.00 + 0.04	1.00 + 0.04	1.00 + 0.04	0.100 + 0.006
		5 Hz – 10 Hz	0.30 + 0.04	0.30 + 0.04	0.30 + 0.04	0.035 + 0.006
		10 Hz – 5 kHz	0.10 + 0.04	0.10 + 0.04	0.10 + 0.04	0.015 + 0.006
		5 kHz – 10 kHz	0.15 + 0.04	0.15 + 0.04	0.15 + 0.04	0.030 + 0.006
10 mA	< 0.15 V	3 Hz – 5 Hz	1.00 + 0.04	1.00 + 0.04	1.00 + 0.04	0.100 + 0.006
		5 Hz – 10 Hz	0.35 + 0.04	0.35 + 0.04	0.35 + 0.04	0.035 + 0.006
		10 Hz – 5 kHz	0.10 + 0.04	0.10 + 0.04	0.10 + 0.04	0.015 + 0.006
		5 kHz – 10 kHz	0.18 + 0.04	0.18 + 0.04	0.18 + 0.04	0.030 + 0.006
100 mA	< 0.7 V	3 Hz – 5 Hz	1.00 + 0.04	1.00 + 0.04	1.00 + 0.04	0.100 + 0.006
		5 Hz – 10 Hz	0.30 + 0.04	0.30 + 0.04	0.30 + 0.04	0.035 + 0.006
		10 Hz – 5 kHz	0.10 + 0.04	0.10 + 0.04	0.10 + 0.04	0.015 + 0.006
		5 kHz – 10 kHz	0.15 + 0.04	0.15 + 0.04	0.15 + 0.04	0.030 + 0.006
2 A	< 0.8 V	3 Hz – 5 Hz	1.00 + 0.04	1.00 + 0.04	1.00 + 0.04	0.100 + 0.006

5 Hz – 10 Hz	0.35 + 0.04	0.35 + 0.04	0.35 + 0.04	0.035 + 0.006
10 Hz – 5 kHz	0.23 + 0.04	0.23 + 0.04	0.23 + 0.04	0.015 + 0.006
5 kHz – 10 kHz	0.23 + 0.04	0.23 + 0.04	0.23 + 0.04	0.030 + 0.006

Additional Crest Factor Errors (non-sine wave)

Crest Factor	Error (% of reading)
1-2	0.05%
2-3	0.15%
3-4	0.30%
4-5	0.40%

Additional Low Frequency Errors (% of reading)

Frequency	Speed		
	1/s (>3 Hz)	5/s (>20 Hz)	20/s (>200 Hz)
10 Hz~20 Hz	0	0.74	-
20 Hz~40 Hz	0	0.22	-
40 Hz~100 Hz	0	0.06	0.73
100 Hz~200 Hz	0	0.01	0.22
200 Hz~1 k Hz	0	0	0.18
>1 k Hz	0	0	0

Measuring Characteristics

True RMS AC Voltage	Measurement Method:	AC-coupled True RMS – measures the ac component of input with up to 400 Vdc of bias on any range.	
	Crest Factor	Maximum 5:1 at full scale	
AC Bandwidth	Speed	Bandwidth	
	1/s (>3 Hz)	3 Hz – 300 kHz (ACI:3 Hz – 10 kHz)	
	5/s (>20 Hz)	20 Hz – 300 kHz (ACI:20 Hz – 10 kHz)	
	20/s (>200 Hz)	200 Hz – 300 kHz (ACI:200 Hz – 10 kHz)	
	Input Impedance:	1 MΩ ± 2%, in parallel with 100 pF	
	Input Protection:	400 Vrms on all ranges	
True RMS AC Current	Range	Shunt	Burden Voltage
	100 μA	100 Ω	<0.020 V
	1 mA	100 Ω	<0.20 V
	10 mA	10 Ω	<0.15 V
	100 mA	1 Ω	<0.7 V
	2 A	0.1 Ω	<0.8 V
	Input Protection:	Internal 2 A, 250V fuse_T for 2 A	

Operating Characteristics

Function	Speed	Digits	AC Bandwidth
ACV	1/s (>3 Hz)	6 ½	3 Hz – 300 kHz
	5/s (>20 Hz)	5 ½	20 Hz – 300 kHz
	20/s (>200 Hz)	4 ½	200 Hz – 300 kHz
ACI	1/s (>3 Hz)	6 ½	3 Hz – 10 kHz
	5/s (>20 Hz)	5 ½	20 Hz – 10 kHz
	20/s (>200 Hz)	4 ½	200 Hz – 10 kHz

- [1]. AC Specification: It will be available after 60 minutes of warm-up, sine wave as well as 1/s speed rate.
- [2]. The entire range of measurement will pass the set range by 20% except the tests of 400 VAC and 2 A AC.
- [3]. Specifications are for sinewave input >5% of range. For inputs from 1% to 5% of range and <50 kHz, add 0.1% of range additional error. For 50 kHz to 100 kHz, add 0.13% of range. The measurement range of 400 VAC is limited within the range of 7.5×10^7 Volt-Hz.
- [4]. Three speed settings provided for low-frequency performance: 1/s (3 Hz), 5/s (20 Hz), 20/s (200 Hz). Additional errors will Not occur for the frequency greater than the filter settings.
- [5]. Specifications are for sinewave input >5% of range, and is beyond 10 μ A AC. For inputs from 1% to 5% of range, add 0.1% of range additional error.

Frequency and Period Characteristics

Frequency Period ^[1] ^[2]

Range	Frequency	24 Hour TCAL ± 1 °C	90 Day TCAL ± 5 °C	1 Year TCAL ± 5 °C	Temperature Coefficient/°C
100 mV ~	3 Hz – 5 Hz	0.100	0.100	0.100	0.100
400 V ^[3]	5 Hz – 10 Hz	0.050	0.050	0.050	0.035
	10 Hz – 40 Hz	0.030	0.030	0.030	0.015
	40 Hz – 1 M Hz ^[4]	0.006	0.006	0.006	0.015

Accuracy Specifications: ± % of reading

Measuring Characteristics

Frequency and Period	Measurement Method:	Reciprocal-counting technique. AC-coupled input using the ac voltage measurement function.
	Voltage Ranges	100 mVrms full scale to 400 Vrms. Auto or manual ranging.
Settling Considerations		Errors will occur when attempting to measure the frequency or period of an input following a dc offset voltage change. The input blocking RC time constant must be allowed to fully settle (up to 1 sec) before the most accurate measurements are possible.
Measurement Considerations		All frequency counters are susceptible to error when measuring low-voltage, low-frequency signals. Shielding inputs from external noise pickup is critical for minimizing measurement errors.

Operating Characteristics

Function	Gate Time	Digits
Frequency, Period	1 s, 100 ms	6 ½
	10 ms	5 ½
	1 ms	4 ½

[1]. This specification will be available after 60 minutes of warm-up and sine wave input, unless stated otherwise. This specification applies to 1s gate time.

[2]. This specification is available when both sine wave and square wave input ≥ 100 mV. For the input of 10 mV to 100 mV, the % of reading error needs to be multiplied by 10 times.

[3]. The amplitude range is from 10% to 120% and is lower than 400 VAC.

[4]. The input ≥ 60 mV, for 300 k ~ 1 MHz, within 100mV range.

Temperature Characteristics ^[1]

(Exclusive of probe errors)

RTD (Accuracy based on PT100):

(100 Ω platinum [PT100], D100, F100, PT385, PT3916, or user type)

Range	Resolution	1 Year (23°C \pm 5°C)	Temperature Coefficient 0°-18°C & 28°-55°C
-200 °C~ -100 °C	0.001 °C	0.09 °C	0.004 °C / °C
-100 °C~-20 °C	0.001 °C	0.08 °C	0.005 °C / °C
-20 °C~20 °C	0.001 °C	0.06 °C	0.005 °C / °C
20 °C~100 °C	0.001 °C	0.08 °C	0.005 °C / °C
100 °C~300 °C	0.001 °C	0.12 °C	0.007 °C / °C
300 °C~600 °C	0.001 °C	0.22 °C	0.009 °C / °C

Thermocouples (Accuracy based on ITS-90):

Type	Range	Resolution	90 Day/1 Year (23 °C \pm 5 °C)*	Temperature Coefficient 0°-18 °C & 28°-55 °C
E	-200 to +1000 °C	0.002 °C	0.2 °C	0.03 °C / °C
J	-210 to +1200 °C	0.002 °C	0.2 °C	0.03 °C / °C
T	-200 to +400 °C	0.002 °C	0.3 °C	0.04 °C / °C
K	-200 to +1372 °C	0.002 °C	0.3 °C	0.04 °C / °C
N	-200 to +1300 °C	0.003 °C	0.4 °C	0.05 °C / °C
R	-50 to +1768 °C	0.01 °C	1 °C	0.14 °C / °C
S	-50 to +1768 °C	0.01 °C	1 °C	0.14 °C / °C
B	+350 to +1820 °C	0.01 °C	1 °C	0.14 °C / °C

*Relative to simulated junction

Thermistor: (2.2 kΩ, 5 kΩ, 10 kΩ or User Type)

Range	Resolution	90 Day/1 Year (23 °C±5 °C)*	Temperature Coefficient / °C
-80 ° to 150 °C	0.001 °C	0.1 °C	0.003 °C/ °C

	Speed	Digits
TCO/RTD/ Thermistor	5 /s , 20 /s , 60 /s , 100 /s	6 ½
	400 /s , 1.2 k /s , 2.4 k /s	5 ½
	4.8 k /s , 7.5 k /s , 14.4k , 19.2k , 38.4k	4 ½

[1]. The actual measurement range and test lead error will be constrained by the adopted test lead. The test lead accuracy adder covers all errors of measurements and ITS-90 temperature change.

Capacitance [1]

Range	24 Hour TCAL ± 1 °C	90 Day TCAL ± 5 °C	1 Year TCAL ± 5 °C	Temperature Coefficient/ °C
1.000 nF	2.00 + 2.00	2.00 + 2.00	2.00 + 2.00	0.05 + 0.01
10.00 nF	2.00 + 1.00	2.00 + 1.00	2.00 + 1.00	0.05 + 0.01
100.0 nF	2.00 + 0.40	2.00 + 0.40	2.00 + 0.40	0.05 + 0.01
1.000 μF	2.00 + 0.40	2.00 + 0.40	2.00 + 0.40	0.05 + 0.01
10.00 μF	2.00 + 0.40	2.00 + 0.40	2.00 + 0.40	0.05 + 0.01
100.0 μF	2.00 + 0.40	2.00 + 0.40	2.00 + 0.40	0.05 + 0.01

Accuracy Specifications: ± (% of reading + % of range)

[1]. Specifications are for film Capacitance inputs that are greater than 10% range. range.

Capacitance

Measurement method: DC recharge & discharge.

Input protection: 500 Vpeak on all ranges.

The capacitor under test (Cx) is charged using a constant current source. The time to charge Cx is recorded. The capacitor is then discharged using a known resistance and the discharge time is recorded. The value of the resistance depends on the capacitance range that is selected. The charge and discharge time is used to calculate the capacitance of Cx if the selected capacitance range is equal to or less than 10 nF. Only the charge time is used to calculate the capacitance of Cx if the selected capacitance range is equal to or greater than 100 nF.

As measuring capacitance with the DMM is effectively a DC measurement, the measured capacitance tends to be higher than what is measured by LCR meters.

For best measurement results, first perform a zeroing of the test leads when the cables are “open” to compensate for the test lead capacitance.

Model description	Type	Speed (ch/sec)	Max volts	Max amps	Bandwidth	Thermal offset	Comments
DAQ-900 20 ch Multiplexer	2-wire solid-state (4-wire selectable)	450	120 V		10 MHz	< 4 μ V	Built-in cold junction reference
DAQ-901 20 ch Multiplexer + 2 current channels	2-wire armature (4-wire selectable)	80	300 V	1 A	10 MHz	< 4 μ V	Built-in cold junction reference 2 additional current channels (22 total)
DAQ-903 40 ch Single-Ended Mux	1-wire armature (common low)	80	300 V		10 MHz	< 1 μ V	No four-wire measurements
DAQ-904 4 x 8 Matrix	2-wire armature		300 V		10 MHz	< 1 μ V	
DAQ-909 8 ch HV Multiplexer + 2 current channels	2-wire armature (4-wire selectable)	60	DC600V AC400V	2 A	10 MHz	< 4 μ V	2 additional current channels (10 total)
DAQ-908 20-channel Actuator/General Purpose Switch	SPDT/from C		300 V		10 MHz	< 4 μ V	

Internal DMM measurement functions supported

	DAQ-900	DAQ-901	DAQ-903	DAQ-904/DAQ-908	DAQ-909
AC/DC Voltage	√ ^{2,3}	√	√		√
AC/DC Current		√			√
Freq./Period	√	√	√		√
2Wire Resistance	√ ¹	√	√		√
4Wire Resistance	√ ¹	√			√
Thermocouple	√	√			√ ⁴
2Wire RTD		√	√		√
4Wire RTD		√			√
Transistor		√	√		√
Capacitance		√	√		√

- [1]. For the measurement of 100 Ω and 1 k Ω resistance ranges, it is recommended to use 4-wire resistance. The maximum resistance range of DAQ-900 is 1 M Ω .
- [2]. When measuring AC voltage, the input impedance will decrease with frequency. A source impedance of 5 Ω or less will maintain specification over frequency. A source impedance of 50 Ω or less will maintain specification in the 5 kHz range.
- [3]. For DC voltage measurement, if the integration time is short and the source impedance is high, more stabilization time may be required.
- [4]. Need to use an extension cable moving the cold junction outside the chassis and manually set the reference temperature value.

Dimensions – DAQ-9600

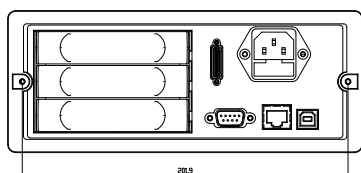
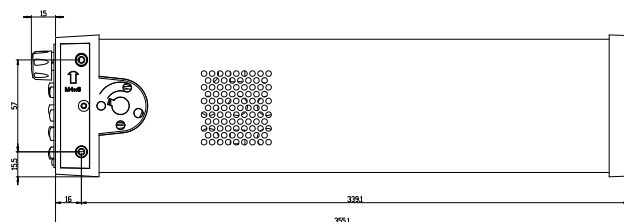
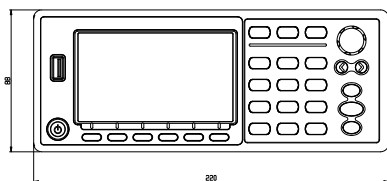
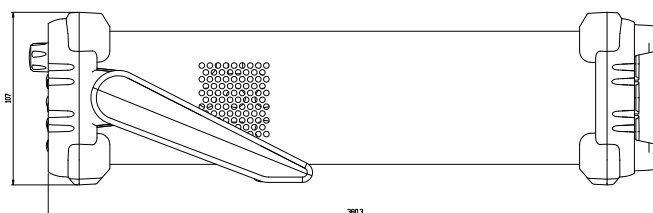
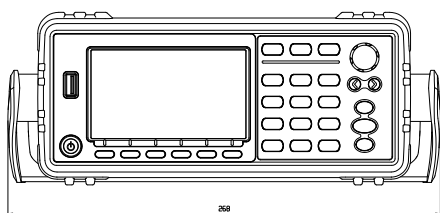

All dimensions are shown in millimeters.

Dimensions – Module

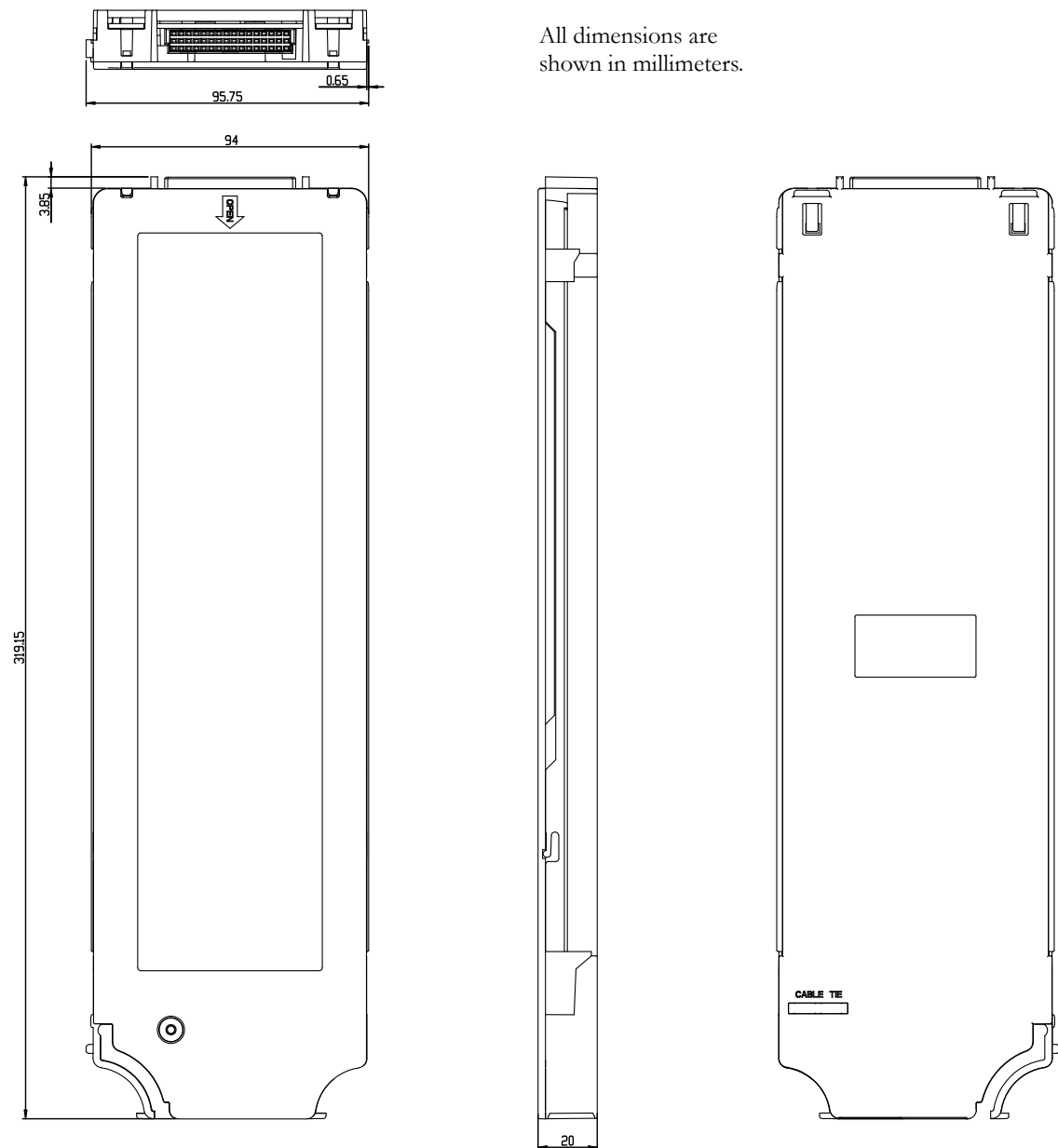

Declaration of Conformity

We

GOOD WILL INSTRUMENT CO., LTD.

declare that the CE marking mentioned product

satisfies all the technical relations application to the product within the scope of council:

Directive: EMC; LVD; WEEE; RoHS

The product is in conformity with the following standards or other normative documents:

◎ EMC	
EN 61326-1 :	Electrical equipment for measurement, control and laboratory use — EMC requirements
Conducted & Radiated Emission EN 55011 / EN 55032	Electrical Fast Transients EN 61000-4-4
Current Harmonics EN 61000-3-2 / EN 61000-3-12	Surge Immunity EN 61000-4-5
Voltage Fluctuations EN 61000-3-3 / EN 61000-3-11	Conducted Susceptibility EN 61000-4-6
Electrostatic Discharge EN 61000-4-2	Power Frequency Magnetic Field EN 61000-4-8
Radiated Immunity EN 61000-4-3	Voltage Dip/ Interruption EN 61000-4-11 / EN 61000-4-34
◎ Safety	
EN 61010-1 :	Safety requirements for electrical equipment for measurement, control, and laboratory use - Part 1: General requirements

GOODWILL INSTRUMENT CO., LTD.

No. 7-1, Jhongsing Road, Tucheng District, New Taipei City 236, Taiwan

Tel: [+886-2-2268-0389](tel:+886-2-2268-0389)

Fax: [+886-2-2268-0639](tel:+886-2-2268-0639)

Web: <http://www.gwinstek.com>

Email: marketing@goodwill.com.tw

GOODWILL INSTRUMENT (SUZHOU) CO., LTD.

No. 521, Zhujiang Road, Snd, Suzhou Jiangsu 215011, China

Tel: [+86-512-6661-7177](tel:+86-512-6661-7177)

Fax: [+86-512-6661-7277](tel:+86-512-6661-7277)

Web: <http://www.instek.com.cn>

Email: marketing@instek.com.cn

GOODWILL INSTRUMENT EURO B.V.

De Run 5427A, 5504DG Veldhoven, The Netherlands

Tel: [+31-\(0\)40-2557790](tel:+31-(0)40-2557790)

Fax: [+31-\(0\)40-2541194](tel:+31-(0)40-2541194)

Email: sales@gw-instek.eu

INDEX

Accessories.....	11	overview	17
Command set		Refresh rate	28, 29, 30, 31, 32
CONFigure commands	226, 263	Remote control	
ROUTE commands	331	Command list.....	216, 217, 218, 219, 220, 221, 222, 223, 224, 225
SENSe commands.....	303	Command syntax	213
STATus report commands	258, 308, 321	Remote terminal session	
SYSTEM related commands	312, 328	telnet	208
Crest factor.....	57, 58	Safety instruction	
Declaration of conformity	362	fuse	7
Digital I/O		Line voltage.....	7
configuration	138	symbol	5
External trigger application	140, 142	Specifications	
Disposal instructions	8	AC	
EN 61010		characteristics	352
measurement category	6	measuring characteristics.....	354
pollution degree	8	Operating characteristics	355
Environment		DC	
operation.....	8	characteristics	348, 358
storage	8	measuring characteristics	350
Ethernet configuration		Dimensions	360, 361
activation.....	192, 193	Frequency and Period	
DHCP	195	characteristics	356
IP 185, 196		measuring characteristics	356, 359
Front panel		Operating characteristics	357
overview.....	13, 19	General	347
Fuse		Temperature characteristics	357
AC fuse replacement	342	Status system.....	336
safety instruction	7	Table of contents	3
Getting Started chapter	9	Temperature	
GPIB configuration	189	RTD setting.....	64, 66
Line voltage safety instruction	7	Thermocouple	
Main features.....	10	junction setting.....	62
Rear panel		setting	61

Triggering	50	overview	209
Web control		Web control interface	209