

**dataTec**

Ihr Ansprechpartner /  
Your Partner:

dataTec AG  
E-Mail: [info@datatec.eu](mailto:info@datatec.eu)  
>>> [www.datatec.eu](http://www.datatec.eu)



Authorized  
Distributor

Mess- und Prüftechnik. Die Experten.

# NI PXI Product Catalog

Test

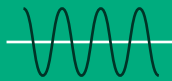

Automate



Measure

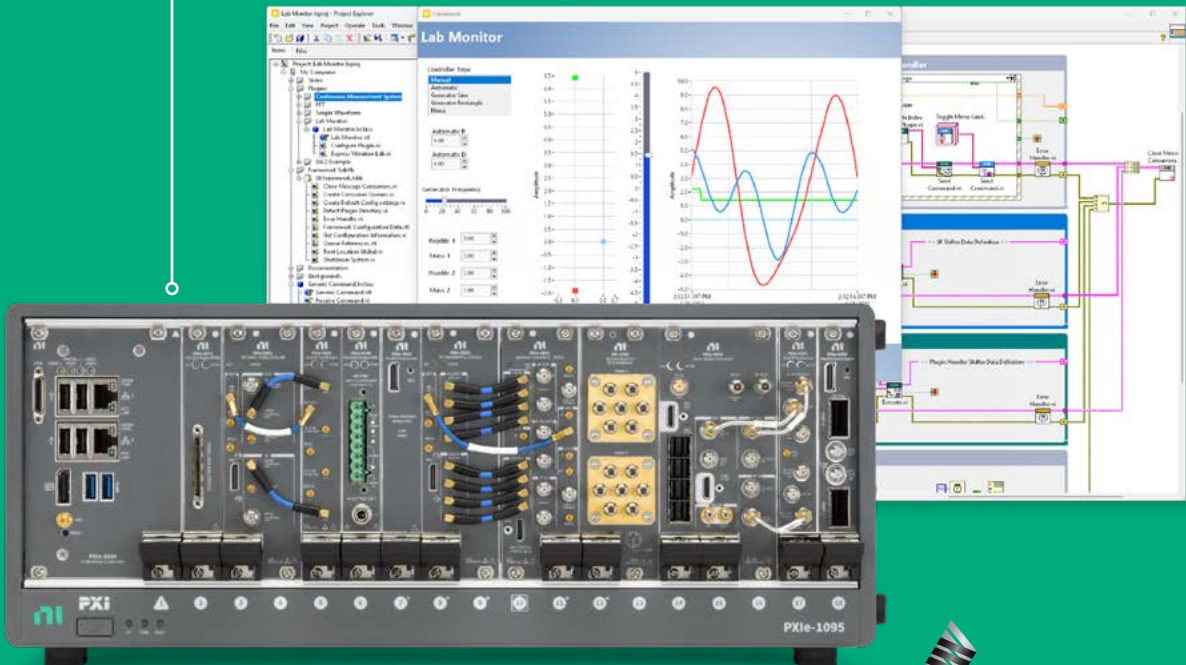

July 2024

EMERSON



# Contents

- 03** What Makes NI Different for Test and Measurement
  - 04 Find NI Anywhere There Is Test
  - 04 Companies and Engineers Seeing Success with NI Today
  - 05 NI Hardware Is Modular
- 07** Why Choose LabVIEW for Test
  - 07 Program Like You Think
  - 08 LabVIEW Connects to Everything in Your Test System
  - 08 Build a Custom User Interface in Minutes
  - 09 Integrate Code from Other Programming Languages
- 10** Get Access to All the Software You Need in the LabVIEW+ Suite
- 12** NI Test Software Overview
  - 14 NI LabVIEW
  - 15 NI G Web Development Software
  - 16 NI TestStand
  - 17 NI DIAdem
  - 18 NI FlexLogger Software
  - 19 NI InstrumentStudio™ Software
- 20** PXI Systems
  - 20 Why PXI for Automated Test?
  - 21 How to Build a PXI Test and Measurement System
  - 22 PXI Chassis
  - 27 PXI Controllers
  - 31 PXI Remote Controllers and System Expansion
- 34** PXI Instrument Overview
  - 36 PXI Oscilloscopes
  - 41 PXI Digital Multimeters
  - 43 PXI Waveform Generator
  - 45 PXI Counter/Timers
  - 47 PXI Power Supplies
  - 49 PXI Switches
  - 50 NI Switch Executive Software
  - 59 PXI Source Measure Units
  - 63 PXI LCR Meter and SMU
  - 65 PXI Digital Pattern Instruments
  - 66 NI Digital Pattern Editor Application Software
  - 67 PXI Digital Waveform Instruments
  - 70 PXI Electronic Loads
  - 72 PXI High-Speed Serial
  - 75 PXI Timing and Synchronization
- 77 PXI Sound and Vibration Modules
- 80 PXI Signal-Conditioning Modules
- 85 PXI Reconfigurable I/O Module (FPGA)
- 88 PXI NI FlexRIO
- 100** PXI DAQ
  - 100 PXI Analog I/O
  - 100 PXI Digital I/O
  - 100 PXI Multifunction I/O
- 107** RF
  - 108 Vector Signal Transceivers
  - 110 Vector Network Analyzers
  - 112 Software Defined Radios
  - 115 NI RFmx
- 116** Instrument Control: GPIB, Serial
- 117** NI Partner Network
  - 117 Types of Partners
  - 118 Hardware Services
  - 119 Education Services
  - 119 Technical Support Services

# What Makes NI Different for Test and Measurement

At our core, we're passionate about test technology and improving product performance. We know your research or latest product design will move markets and improve the world we live in. We're here to help you.

## We Are Software-Obsessed

NI products are designed for software. From simple USB devices to advanced RF testbeds, engineers working with NI systems see software as a defining element of test.

## Our Hardware Is Modular

You may be used to purpose-built boxed instruments; when you need a new measurement or more channels, you buy a whole new box. With NI hardware, you change or add measurements by adding new modules. Just like you upgrade your PC with a new graphics card, you can upgrade your NI test system with a new oscilloscope module.

## The NI Ecosystem Is Open

Test engineers benefit most when they combine NI software with NI hardware, but NI hardware works with other (non-LabVIEW) popular programming languages and NI software connects to non-NI hardware. Choose the tools that work for you.

## Why NI for Test

Every company says they save you time and money. Here are the challenges NI solves to do it.



### Flexibility

Changing designs, market needs, and supply chains challenge product development. Use NI tools to adapt and stay on schedule.



### Standardization

Don't spend time and money repeating work. Lower your cost of test by sharing code libraries and hardware architectures amongst all of your test teams.



### Quality

NI is known for data throughput, acquisition rates, synchronization, and measurement quality. Better products need better test.





### Productivity

You are a critical part of test. NI improves your productivity, so you focus more on what matters to you, your team, and your business.

# Find NI Anywhere There Is Test

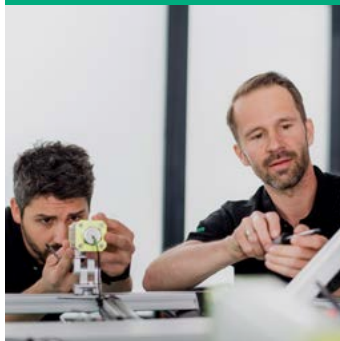
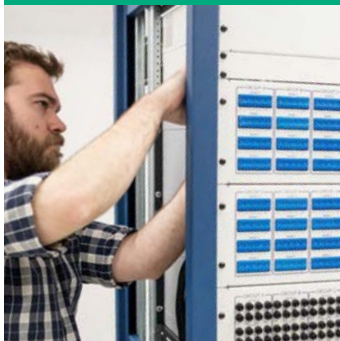
NI works with more than 40,000 customers each year to deliver the test and measurement technology engineers use to create better products, on time, while driving down the cost of test. Find NI anywhere there is test, including:

<p>Quick desktop measurements to test design assumptions</p>	<p>Mechanical and sensor-based tests to validate specifications</p>	<p>Automated software (HIL) test racks to cover the whole test envelope in less time</p>	<p>Manufacturing test systems to improve test quality and throughput</p>
			

## Industries Served

- Semiconductor
- Electronics (consumer and industrial)
- Electrical components (motors, switches)
- White goods and appliances
- Automotive
- Aerospace
- Military and defense
- Life sciences
- Academic (teaching and research)
- Heavy equipment, industrial, and off-highway
- Commercial and government research labs
- Energy: Smart grid
- Energy: Renewables research
- Energy: O&G mid/downstream and well-servicing

## Companies and Engineers Seeing Success with NI Today

**Qorvo**

**2x**

test throughput and prepared for 5G

**Hyundai**

**83%**

lower development time for new test systems per variant

**Honeywell**

**40%**

reduction in cost of each test station

**Philips**

**\$2M+**

reduction in OpEx per project

## Philips Rethinks Functional Test, Shortening Time to Market

“The move to a COTS approach using PXI and LabVIEW was critical to this production-test success at Philips. The combination of best-in-class modular hardware along with industry-standard software was pivotal to millions of dollars and hundreds of hours saved in production test engineering.”

Neil Evans  
Senior Manager, Philips

## Productivity Boost in Post-Silicon Validation

“It was never easier to configure the PXI instruments and run automated measurement without much coding in a few minutes of setup time. I believe the powerful combination between InstrumentStudio™ software and TestStand with the sweep loop is an incredible feature that (will) boost our productivity for debugging activities in postsilicon validation.”

Wolfgang Rominger  
NXP

## NI Hardware Is Modular

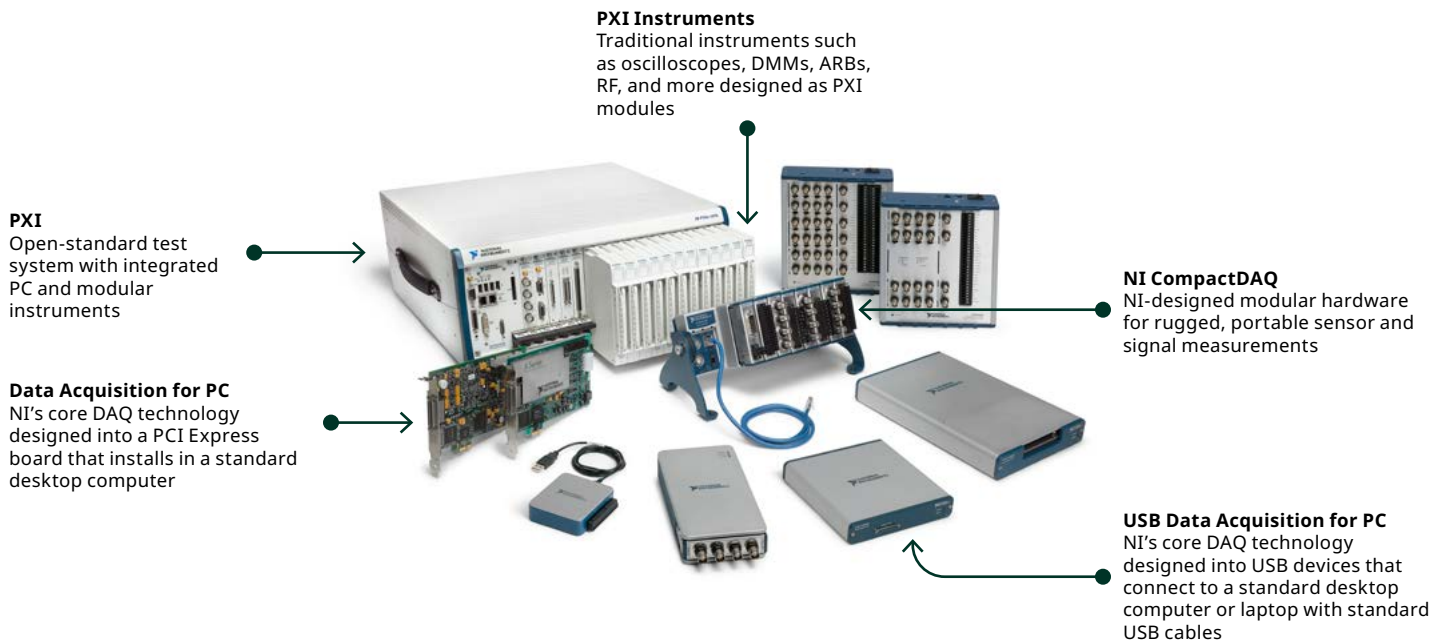

Mix and match NI's modular hardware with a PC to build a custom test and measurement solution for the desktop, lab bench, or production floor.

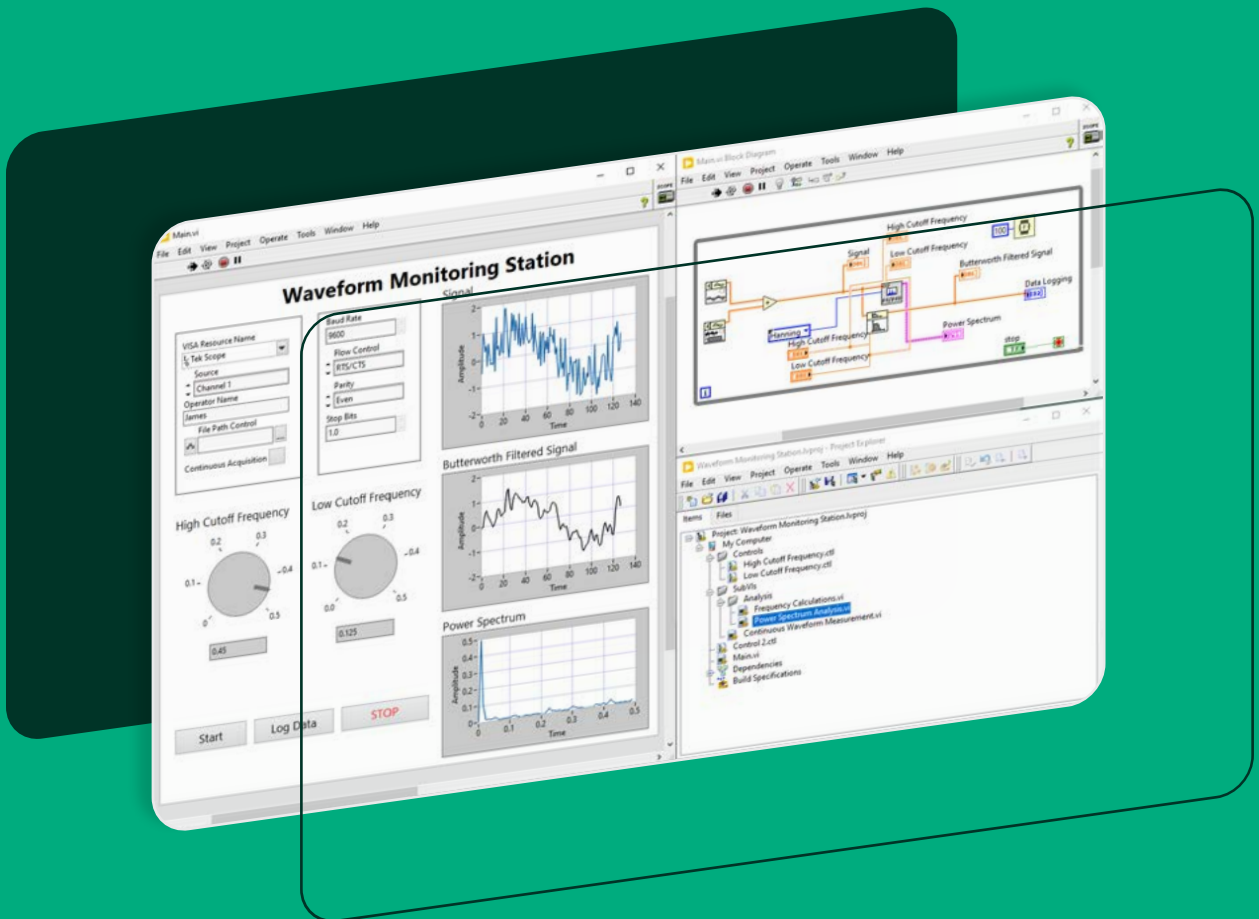

# Why Choose LabVIEW for Test

Our comprehensive software portfolio scales from the instrument to the enterprise, allowing us to serve a complete range of needs, from performing a simple measurement to managing test systems across the globe.

In 1986, we released LabVIEW and have been the leaders in automated test since. From performing a simple voltage measurement to advancing space missions, LabVIEW has been engineers' tool of choice. Let's take a look at why engineers choose LabVIEW:

## Program Like You Think

Graphical data flow in LabVIEW (bottom) is like flowchart logic (top) and considered easier by many to interpret and debug.

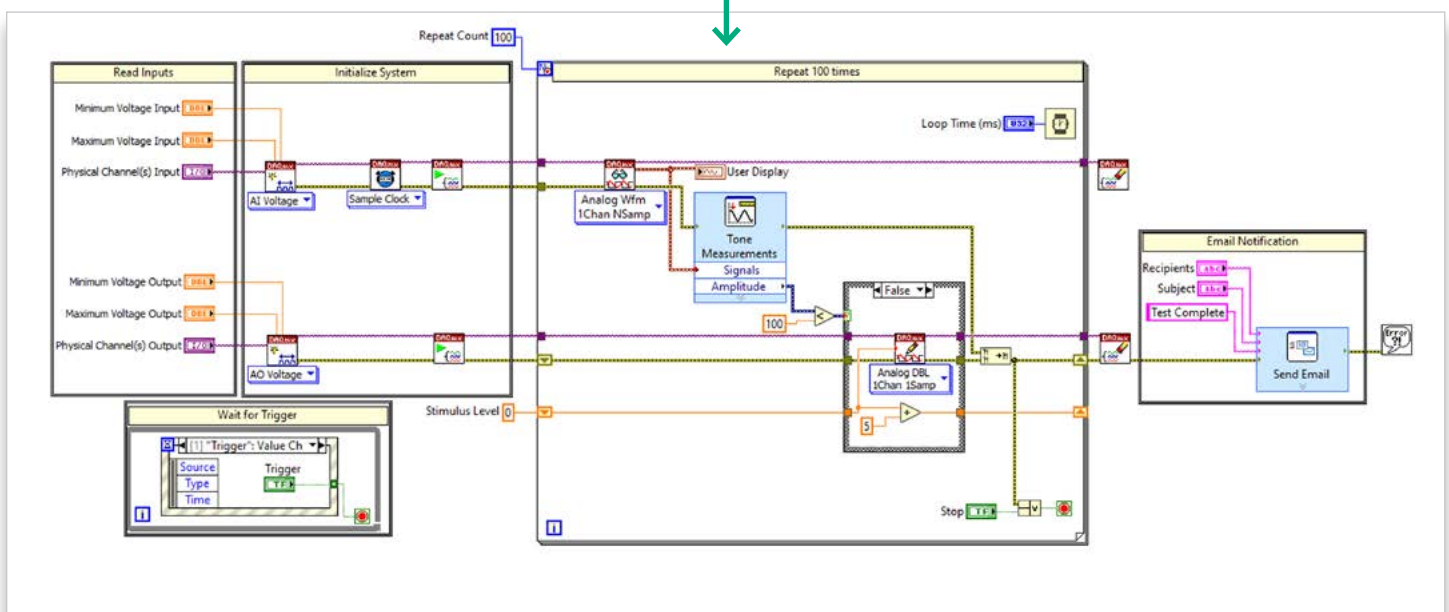
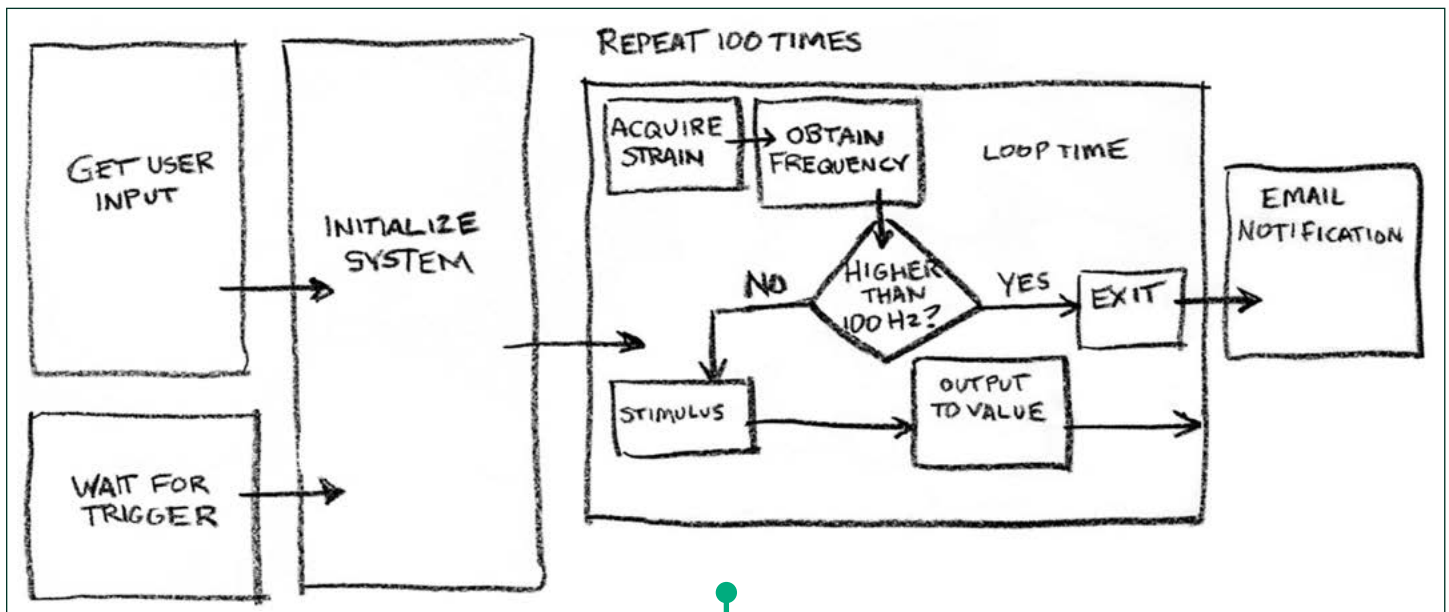

# LabVIEW Connects to Everything in Your Test System

Get unparalleled instrument connectivity with LabVIEW – automate NI and non—NI hardware. Any device is accessible and programmable with thousands of available instrument drivers.

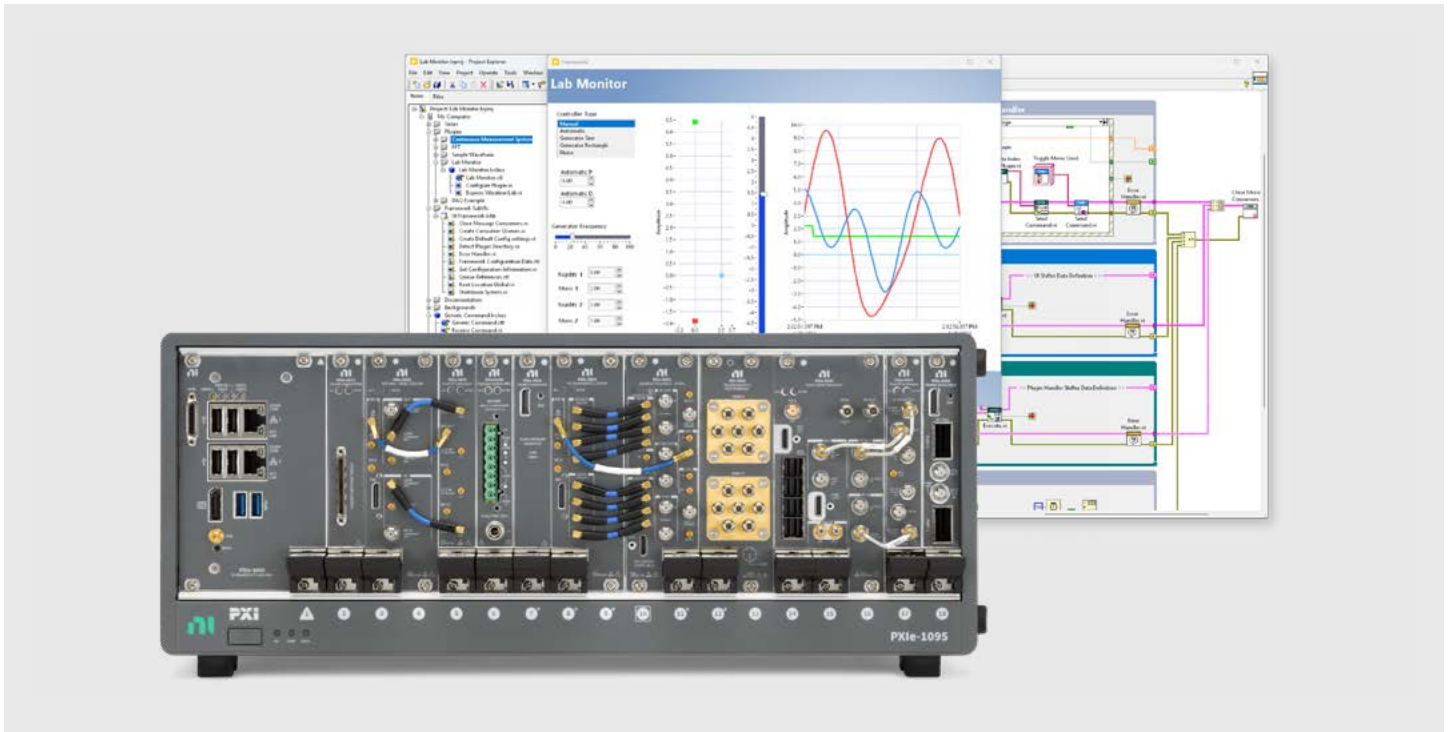

# Build a Custom User Interface in Minutes

Use drag-and-drop UI elements to build a custom professional test panel. The UI elements in LabVIEW are designed specifically for engineers building test and measurement systems.

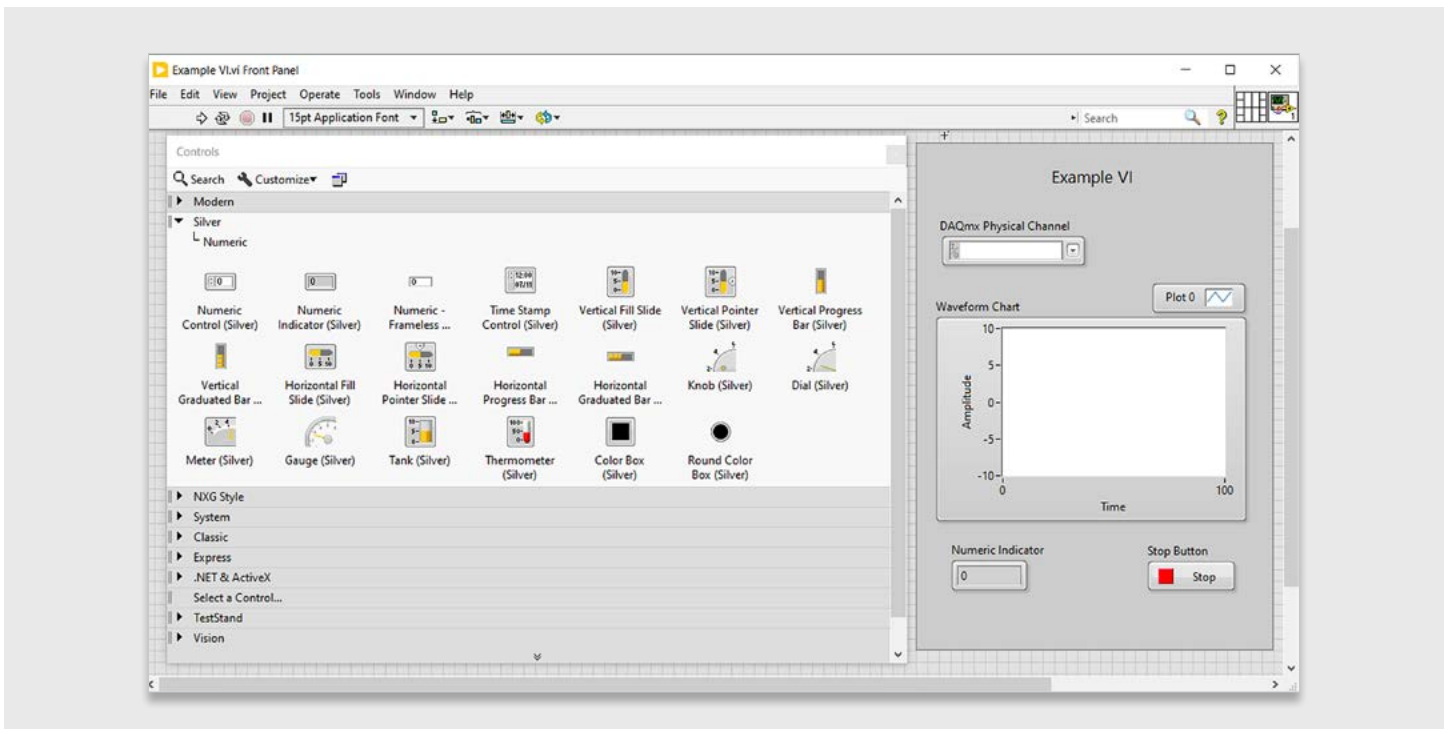



# Integrate Code from Other Programming Languages

Add new algorithms and data analysis routines, and connect to other systems with code written in Python, C, and .NET. Language flexibility and integration save time.

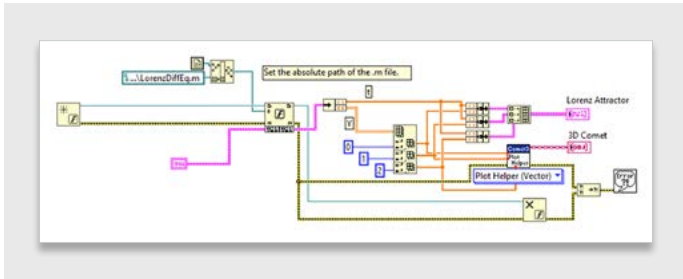

**MATLAB®**

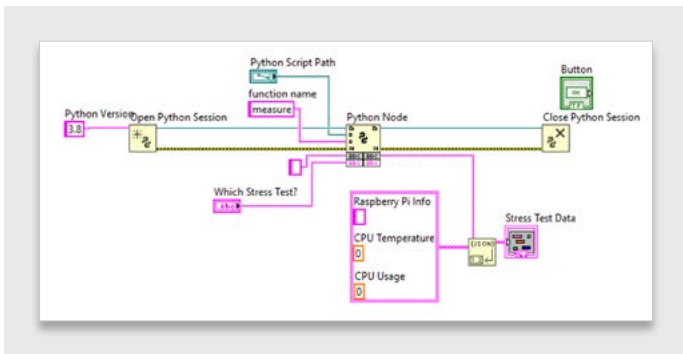

**Python**

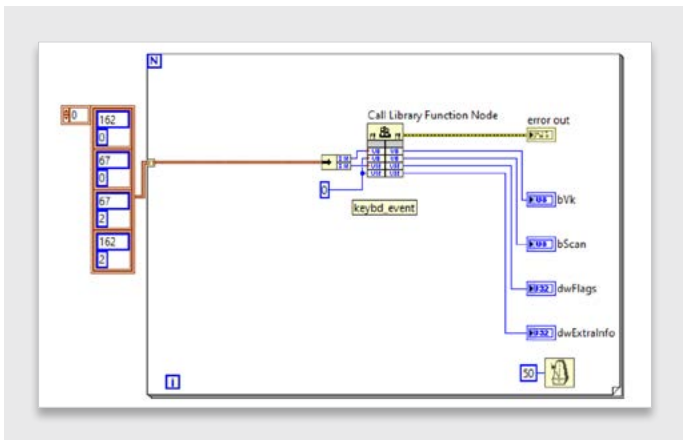

**C/C++, C#**

# Get Access to All the Software You Need in the LabVIEW+ Suite



788509-35

It's LabVIEW, plus whole lot more. The LabVIEW+ Suite brings together the best of NI test software that saves engineers time by optimizing every part of their workflow. Each software includes features and capabilities designed to accelerate test:

- NI LabVIEW is the industry-leading environment for automated test system development.
- NI TestStand is used in validation labs and on manufacturing floors across the world to automate and sequence tests.
- NI DIAdem saves engineers hundreds of hours of manual data analysis and report creation with automation.
- NI FlexLogger and InstrumentStudio software make measurement and instrument configuration a quicker and interactive process.

The suite provides purpose-built tools for automating measurement, analysis, and test that work together to save you time.

## Measure

### Take a Quick Measurement

Configure NI hardware channels for sensor, analog, and digital signals

Interactively set up PXI instruments and debug unexpected behavior

Powered by:



## Test

### Optimize Test for Validation and Production

Create test sequences with code from LabVIEW, Python, C/C++, and .NET

Track units and automatically store test results to your database

Powered by:



## Analyze

### Interactively Analyze Data

Use built-in engineering analysis functions for calculations

View any type of data, quickly and all at once, with segmented displays

Powered by:



### Create and Share Reports

Drag-and-drop to graphics to create shareable reports for your team or organization

Automate your post-processing routine with VBS or Python

Powered by:



# NI Test Software Overview

NI software can be purchased individually or as part of LabVIEW+; short descriptions of the software follow. More information on applications and key features can be found in this section.

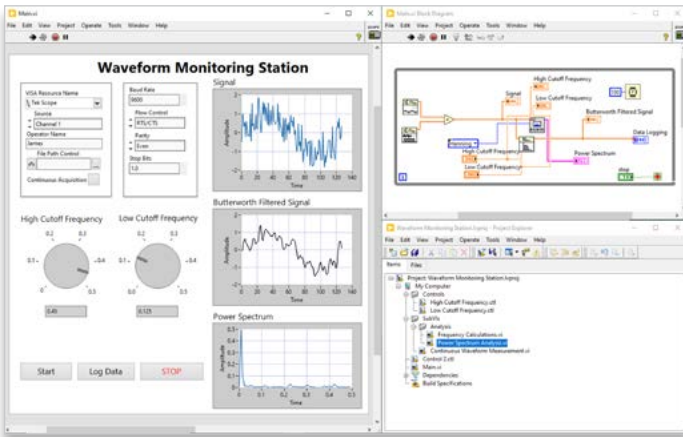

## NI LabVIEW

A graphical programming environment for developing automated test systems with rapid access to hardware and data insights.

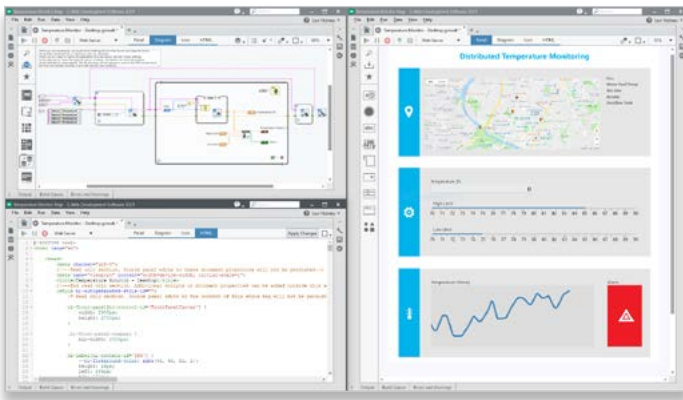

## NI G Web Development Software

A graphical programming environment optimized for developing web applications for test systems.



## NI TestStand

Test executive software for developing test sequences for validation and production testers.

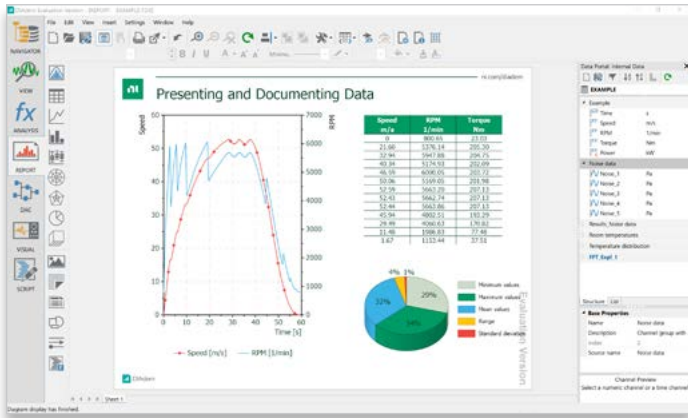

## NI DIAdem

Data analytics software for measurement data search, inspection, analysis, and automated reporting.

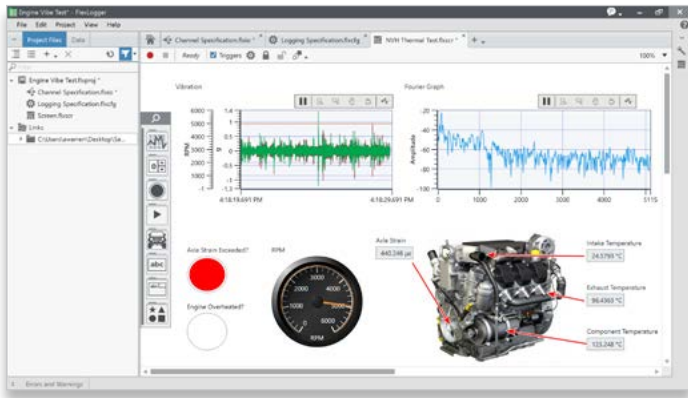

## NI FlexLogger Software

No-code software that accelerates measurement configuration and logging with NI DAQ hardware.

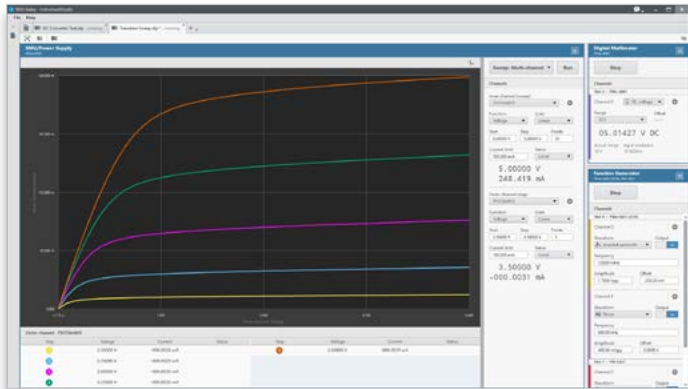

## NI InstrumentStudio Software

Software to configure NI PXI instruments and automate and sequence measurements.

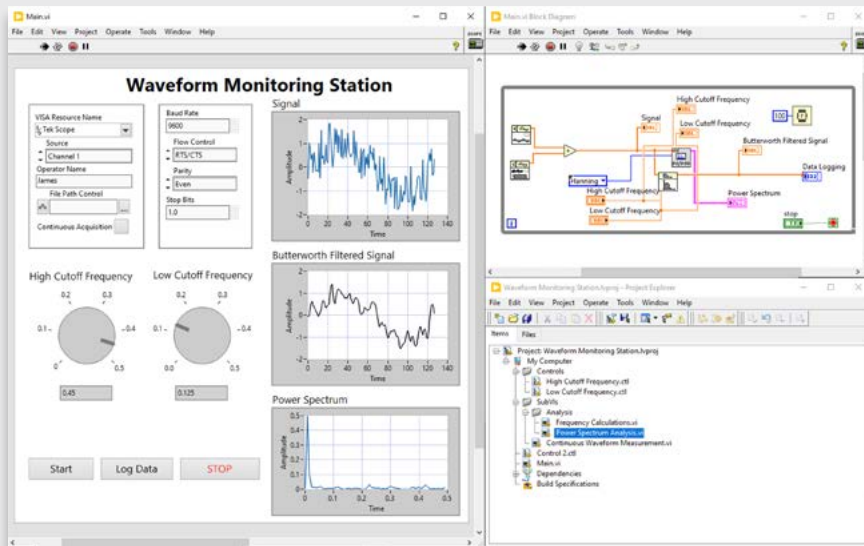

**LabVIEW Base**  
784503-35  
Recommended for simple test and measurement applications.

**LabVIEW Full**  
784522-35  
Recommended for applications needing advanced analysis or signal processing.

**LabVIEW Professional**  
784584-35  
Recommended for engineers who need tools for software engineering, code deployment, distribution, and reporting.

## NI LabVIEW

LabVIEW is a graphical programming environment engineers use to develop automated research, validation, and production test systems.

### Engineers use LabVIEW to:

- Accelerate the development of flexible test systems
- Automate and control any instrument
- Perform data acquisition, analysis, and report generation

### Key Features:

#### Maximize Productivity

- Graphical Programming**—Visualize your test system with a natural flowchart-like data flow.
- Customizable User Interfaces**—Create custom, interactive UIs with prebuilt objects for real-time data display and user input.

#### Integrate Everything

- Hardware Access**—Connect to any device with thousands of drivers for third-party instrumentation.
- Code Reuse**—Call Python, C, MATLAB, and .NET code.

#### Increase Capabilities

- Real-Time and FPGA Modules**—Use add-ons for applications that require embedded hardware and FPGA systems.
- Automated Reporting**—Share test results by generating reports for Microsoft Office or writing to a database, such as MongoDB.

**Active Debugging**—LabVIEW recompiles code after every action. Identify and resolve issues with no last-minute surprises.

**Protocol Support**—Exchange data between applications using TCP/IP, UDP, serial, IrDA, Bluetooth, Modbus, SMTP, and many more.

**Application Builder**—Create and deploy your code as stand-alone applications for other to use in just a few clicks.

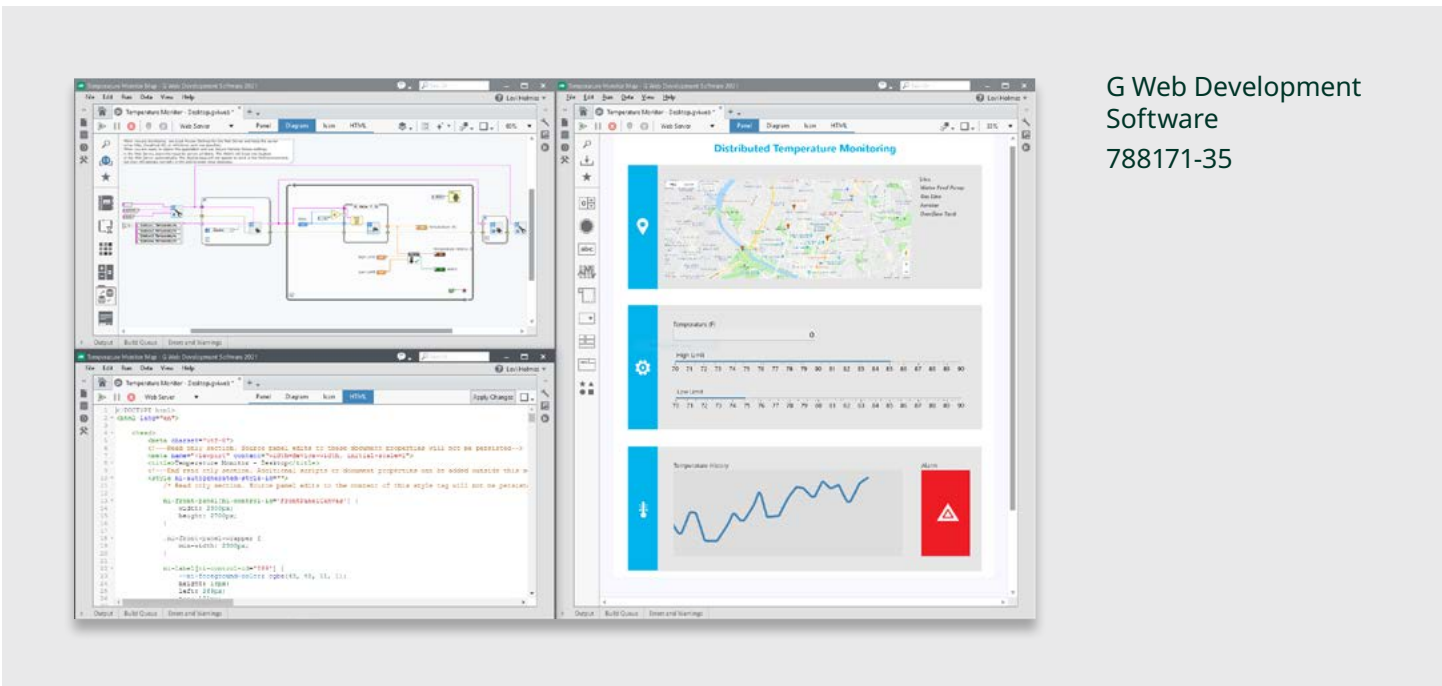

G Web Development Software  
788171-35

## NI G Web Development Software

G Web Development Software helps engineers create web-based user interfaces for test and measurement applications without traditional web development skills.

Engineers use G Web Development Software to build web apps for:

- Accessing their test system remotely
- Sharing test information with colleagues
- Accessing their test system on another device

### Key Features:

- Customizable User Interfaces**—Create custom user interfaces with prebuilt objects for data display and user input.
- Data Communication APIs**—Exchange information with prepackaged APIs that simplify communication. Maintain compatibility with any test system built in LabVIEW, C#, or Python.
- Hosting**—Host your application on your test machine or a dedicated server.

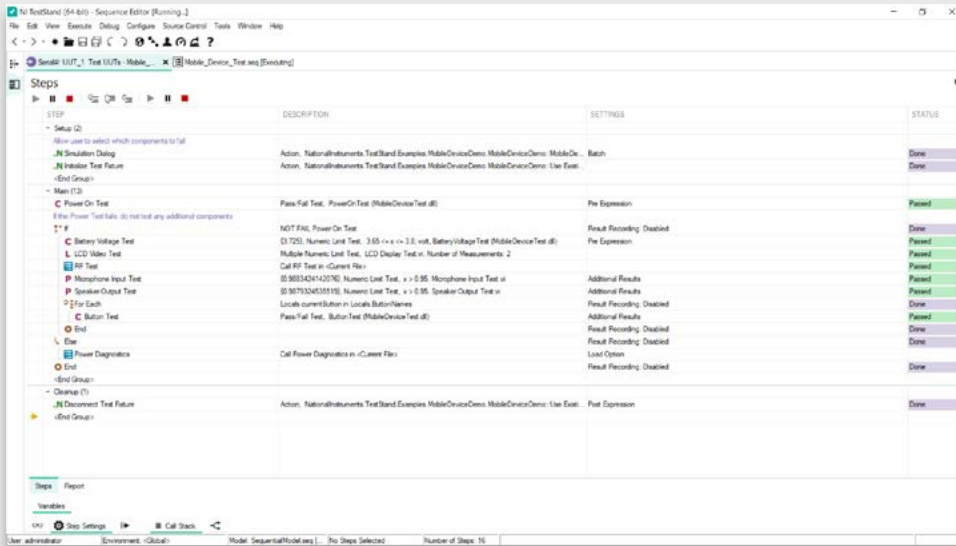

### TestStand Development 788372-35

Recommended for engineers developing test sequences.

### TestStand Deployment Engine 777774-35

Required for deploying test sequences to additional test systems.

## NI TestStand

TestStand is test executive software that accelerates system development and deployment for engineers in validation and production.

### Engineers use TestStand to:

- Rapidly develop, deploy, and manage automated test systems
- Test products in parallel to optimize instrument use and test times with built-in autoscheduling intelligence
- Integrate and sequence tests written in various programming languages
- Log and share test results to local and network databases

### Key Features:

#### Develop Systems Faster

- **Execute Code Modules Written in Multiple Test Languages**—Take advantage of investments in existing test code by integrating with LabVIEW, Python, LabWindows™/CVI software, C#, C++, Microsoft Visual Basic .NET, and more.
- **Drag-and-Drop Development Environment**—Use the TestStand Sequence Editor to quickly sequence, configure, and execute test code modules.

#### Simplify System Deployment

- **TestStand Deployment Utility**—Easily package all required DLLs, source code, drivers, and configuration information into a single installer.
- **Deployment Patching**—Reduce the difficulty of maintaining deployed test stations by building small deployment patches that can be quickly downloaded and installed on target machines.

#### Increase Test Throughput

- **Autoschedule Hardware Resources**—Minimize equipment costs by sharing hardware among multiple threads by using built-in autoscheduling steps.
- **Simplify Parallel Testing**—Leverage multicore processors when scaling from single-unit testing to multiple-unit parallel testing.

#### Record and Publish Test Results

- **Enterprise Connectivity**—Log test results using standard database connectivity or plug-ins for specialized data management systems, such as NI SystemLink™.
- **Built-In Reporting**—Log critical results to several industry-standard report formats, such as ATML, XML, HTML, and ASCII.



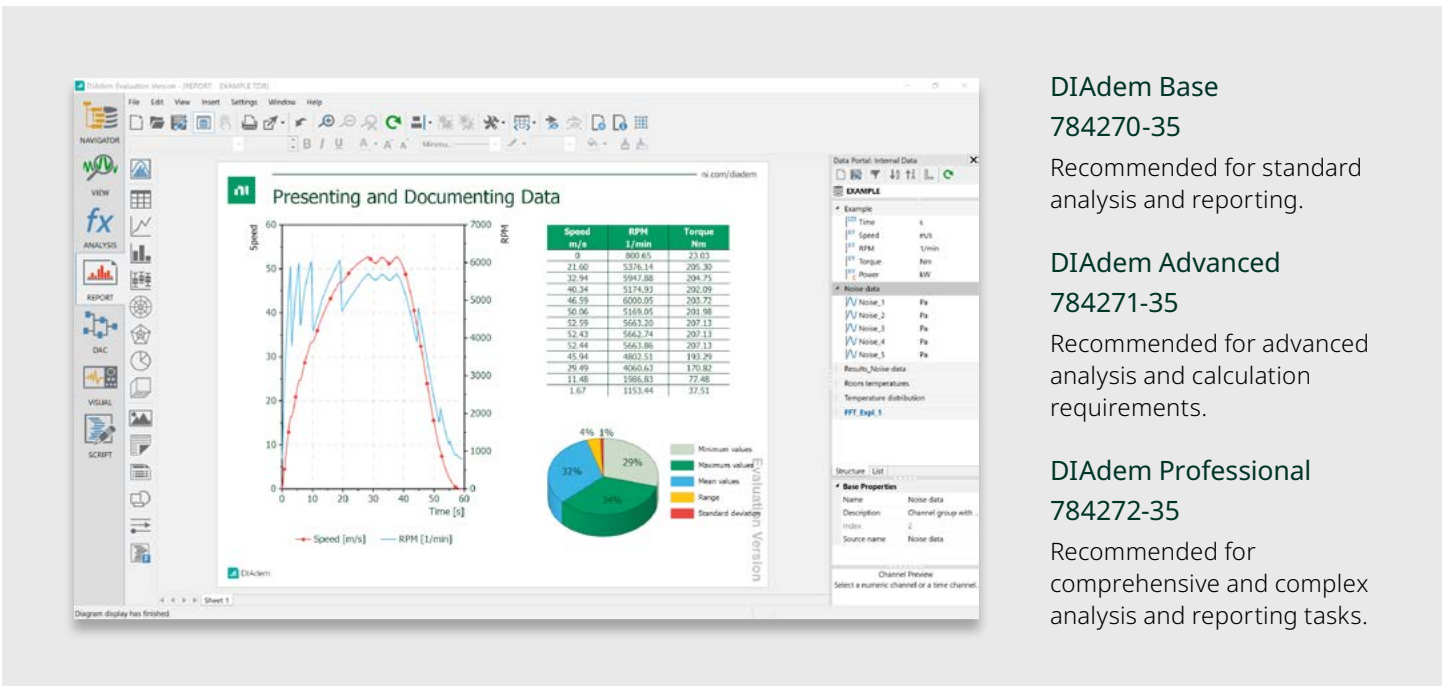

**DIAdem Base  
784270-35**

Recommended for standard analysis and reporting.

**DIAdem Advanced  
784271-35**

Recommended for advanced analysis and calculation requirements.

**DIAdem Professional  
784272-35**

Recommended for comprehensive and complex analysis and reporting tasks.

## NI DIAdem

DIAdem is data-analytics software for measurement data search, inspection, analysis, and automated reporting.

**Engineers use DIAdem to:**

- Search for and find specific data
- Visualize multiple types of test data
- Save time by automating analysis routines and report generation

**Key Features:**

- DataPlugins**—DIAdem can import more than 1,000 file types through a technology called DataPlugins. Utilize the 200+ existing DataPlugins or create your own using an interactive Wizard or API.
- Data Display**—Instantly display data in multiple 2D-axis systems and tables; play audio and video data; and view map data. Use a paneled display to view multiple datasets with different layouts in one window.
- Built-In Functions**—Transform your data with a simple point-and-click interface to perform analysis.
- Script**—Automate your measurement data analysis workflow, from import to analysis to report, by writing scripts in Python and VBS.

**“We have reduced our reporting and analysis time by 95 percent and achieved our goal of replacing the current multistep process with a one-button DIAdem solution.”**

**Jim Knuff**  
Raytheon Missile Systems

FlexLogger  
785748-3501

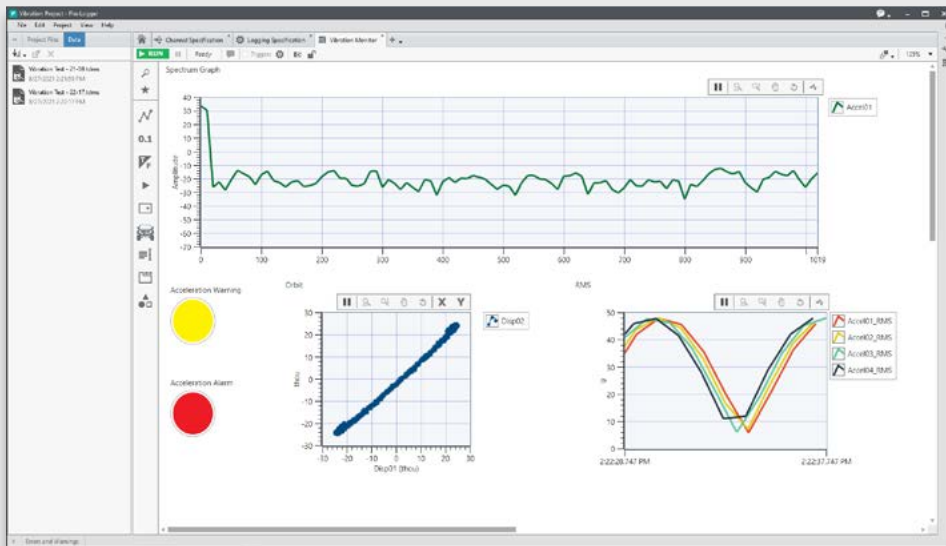

## NI FlexLogger Software

FlexLogger software is no-code software that accelerates measurement configuration and logging with NI DAQ hardware.

Engineers use FlexLogger software to:

- Quickly acquire data to validate designs or assumptions
- Build configurable test systems with a custom UI for operators
- Log data from sensors and electrical signals to disk

Key Features:

- **Calculated Channels**—Perform basic arithmetic on measurement channels and log results to file alongside raw data.
- **Alarms and Events**—Set alarms that monitor single channels or groups to be notified of unexpected behavior. Make quick, informed decisions.
- **File Configuration**—Store data according to your test needs. Built-in functionality can partition files according to file size or time specifications during for long-running tests. Save to multiple locations to reduce risk of data loss.

### FlexLogger Lite

**FlexLogger Lite comes free** with NI DAQ Hardware! It includes standard capabilities such as configuring measurements and saving data. For additional automation and integration of custom measurements, choose the complete version of FlexLogger.

InstrumentStudio  
Professional  
789987-35

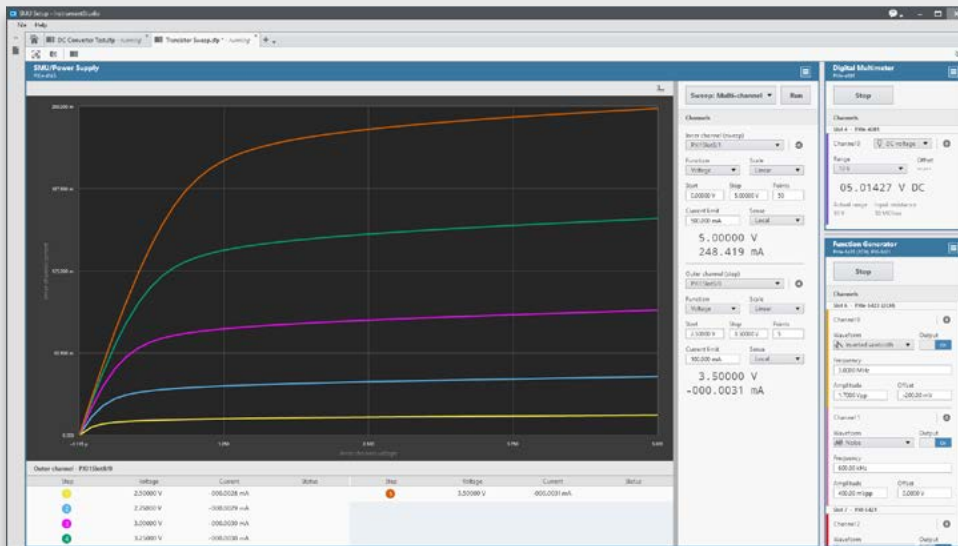

## NI InstrumentStudio™ Software

InstrumentStudio is an interactive configuration-based software for engineers to control and configure instruments, run measurements, and develop and debug test sequences within a single environment.

Engineers use InstrumentStudio software to:

- Validate hardware functionality through instrument bring up, measurement automation, and debugging
- Simultaneously interact with multiple instruments, non-NI hardware, and measurements
- Integrate measurements developed in various programming languages with a common user interface

Key Features:

- **Native Panels for NI PXI Instruments**—Control and configure a wide range of DC, analog, digital, RF, and NI instruments with customizable panels
- **Measurement Plug-Ins**—Run language-agnostic code modules that can be reused across projects, teams, and sites.
- **Develop Test Sequences**—Automate quickly by sequencing instrument and measurement configurations through the sequencer panel. For more advanced validation and production test, utilize copy-paste functionality with TestStand.
- **Export Configurations to Code**—Guarantee correlation by replicating instrument configurations in LabVIEW or any other programming environment using a single API function call.

## InstrumentStudio

**InstrumentStudio comes free** with NI PXI instruments, including oscilloscopes, digital multimeters, waveform generators, VSTs, and more! It includes standard capabilities such as configuring instruments, saving data, and exporting instrument configurations. For additional automation and integration of custom measurements, choose InstrumentStudio Professional.

# PXI Systems

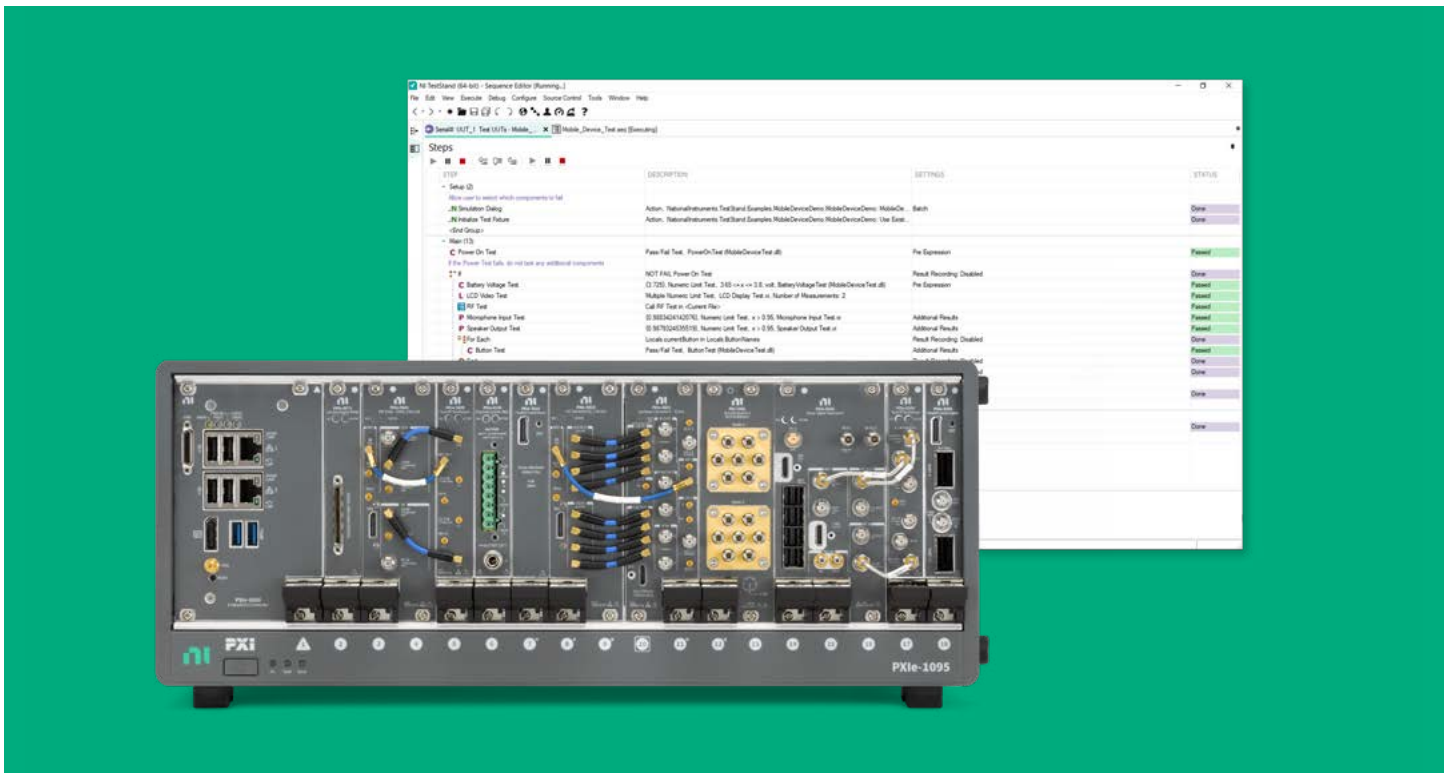

Built for automated test, NI PXI is a rugged, PC-based platform for measurement and automation systems that uses modular instrumentation and software to ensure unparalleled accuracy, timing, and synchronization for high-channel, mixed-measurement applications from the lab to the manufacturing line. Developed in 1997 and launched in 1998, PXI is an open industry standard governed by the PXI Systems Alliance (PXISA), a group of more than 70 companies chartered to promote the PXI standard, ensure interoperability, and maintain the PXI specification across its mechanical, electrical, and software architectures.

## Why PXI for Automated Test?

**Modularity and Scalability**—Use PXI's modular architecture to customize and scale test systems with multiple instruments from DC to the mmWave spectrum. Continuously evolve test systems by integrating new modular instruments, ensuring adaptability to changing requirements.

**Designed for Advanced Applications**—NI PXI offers unparalleled instrument performance, data throughput, latency, and synchronization for advanced test and measurement applications.

**Software-Defined**—NI PXI's open architecture helps you develop application-specific measurement and analysis programs to enhance automated test productivity. With a comprehensive and connected set of software tools, it offers a seamless development experience with a consistent software interface across multiple instruments.

**Vibrant Ecosystem**—With NI's global vendor, integrator, and consultant network, achieve unsurpassed customization and support. Connect with a global community of solution providers, systems integrators, consultants, and product developers ready to guide you to your next innovation.

# How to Build a PXI Test and Measurement System



## 1. Chassis

Use the following Controller Selection Table to select your chassis with built-in controller.



## 2. Controller

For a PXI system with built-in computer:

Shop for a PXI embedded controller just like you would shop for a desktop computer.

To connect a PXI chassis to your laptop using a Thunderbolt™ cable, from the chassis section table, select a chassis with a built-in Thunderbolt cable.



## 3. Instruments (Modules)

Choose your instruments and measurement modules from the PXI Instrumentation section.



## PXI Chassis

### NI PXI chassis offer:

- Up to 24 GB/s system bandwidth and 8 GB/s per-slot of dedicated bandwidth
- Size options ranging from 2 to 18 slots
- Hybrid slots for instrumentation flexibility; compatibility with PXI, PXI Express, CompactPCI, and CompactPCI Express modules
- Up to 82 W per slot of power and cooling for more advanced I/O modules

### Key Features:

#### Timing and Synchronization

NI PXI Express chassis incorporate a dedicated 10 MHz system reference clock, PXI trigger bus, star trigger bus, and slot-to-slot local bus, as well as a 100 MHz differential system clock, differential signaling, and differential star triggers for advanced timing and synchronization.

#### Peer-to-Peer Streaming

Use NI PXI Express chassis and software for peer-to-peer communication from a modular instrument to an FPGA module for inline signal processing that bypasses the PXI embedded controller.

#### Cooling

All NI PXI Express chassis exceed PXI Express requirements by providing at least 38.25 W of power and cooling to every peripheral slot; some chassis push slot cooling capacity even further by providing 58 W or 82 W of cooling to a single slot.

## PXI Chassis Modules

Selection Guide	Model	Part Number	Chassis Power-Supply Type	External Clocking	External Trigger Access	Max System Bandwidth	Slot Count	Onboard Clock Type	Slot Cooling Capacity	System Timing Slot
Low Cost, Small Form Factor Chassis, Older-Generation	<b>PXIe-1071</b>	781368-01	AC	—	—	3 GB/s	Total: 4 Hybrid: 3 PXI Express: 0	VCXO	38 W	—
	<b>PXIe-1073</b>	781163-01	AC	—	—	250 MB/s	Total: 5 Hybrid: 3 PXI Express: 2	VCXO	38 W	—
	<b>PXIe-1090</b>	787040-01	AC	✓	—	2 GB/s	Total: 2 Hybrid: 1 PXI Express: 1	VCXO	58 W	—
	<b>PXIe-1083</b>	787026-01	AC	—	—	2 GB/s	Total: 5 Hybrid: 5 PXI Express: 0	VCXO	58 W	—
Entry-Level, Cost-Competitive, Medium Cooling Capacity	<b>PXIe-1082DC</b>	782946-01	DC	✓	—	8 GB/s	Total: 8 Hybrid: 4 PXI Express: 3	VCXO	38 W	✓
	<b>PXIe-1084</b>	784058-01	AC	—	—	4 GB/s	Total: 18 Hybrid: 17 PXI Express: 0	VCXO	58 W	—
		786397-01	AC	✓	✓	4 GB/s	Total: 18 Hybrid: 17 PXI Express: 0	VCXO	58 W	—
	<b>PXIe-1085</b>	783588-01	AC	✓	—	24 GB/s	Total: 18 Hybrid: 16 PXI Express: 1	VCXO	38 W	✓
	<b>PXIe-1086</b>	781720-01	AC	✓	—	12 GB/s	Total: 18 Hybrid: 16 PXI Express: 1	VCXO	38 W	✓
	<b>PXIe-1086DC</b>	787137-01	DC	✓	—	12 GB/s	Total: 18 Hybrid: 16 PXI Express: 1	VCXO	38 W	✓
	<b>PXIe-1088</b>	784782-01	AC	—	—	8 GB/s	Total: 9 Hybrid: 8 PXI Express: 0	VCXO	58 W	—
Highest Performance, Newest-Generation, Highest Cooling Capacity	<b>PXIe-1092</b>	784781-01	AC	—	—	24 GB/s	Total: 10 Hybrid: 7 PXI Express: 0	VCXO	82 W	✓
		786991-01	AC	✓	✓	24 GB/s	Total: 10 Hybrid: 7 PXI Express: 0	OCXO	82 W	✓
	<b>PXIe-1095</b>	783882-01	AC	—	—	24 GB/s	Total: 18 Hybrid: 5 PXI Express: 11	VCXO	82 W	✓
		785971-01	AC	✓	✓	24 GB/s	Total: 18 Hybrid: 5 PXI Express: 11	OCXO	82 W	✓

## PXI Chassis Accessories

### MXI-Express Cable

Part Number	779500-01	779500-03	779500-07
Description	MXI-Express Cable, Gen 1 X1, Copper, 1 m	MXI-Express Cable, Gen 1 X1, Copper, 3 m	MXI-Express Cable, Gen 1 X1, Copper, 7 m
PXIe-1073	✓	✓	✓

### PXI Chassis Trigger Cable

Part Number	149055-0R2
Description	Chassis D-SUB Trigger Breakout Cable To 6 BNC For PFI 0-3, Remote Inhibit and Fault, 20 CM
PXIe-1084	✓
PXIe-1092 Timing and Synchronization (786991-01)	✓
PXIe-1095 Timing and Synchronization (785971-01)	✓

### PXI Rack-Mount Kit

Part Number	788347-01	778948-01	778644-01	778644-02	787525-01	781634-01	786371-01	786372-01	786969-01	786970-01
Description	PXIe-1090 Chassis Rack-Mount Kit	PXI-103X and 107x Rack-Mount Kit	PXI 18-Slot Front Rack-Mount Kit	PXI 18-Slot Rear Rack-Mount Kit	Rack-Mount Kit For PXIe-1088	Rack-Mount Kit For PXIe-1078 and PXIe-1088 (Legacy)	PXI 18-Slot Front Rack-Mount Kit, Extended Recess	PXI 18-Slot Rear Rack-Mount Kit, Extended Recess	PXIe-1092 Chassis Front Rack-Mount Kit, Extended Recess	PXIe-1092 Chassis Rear Rack-Mount Kit, Extended Recess
PXIe-1090	✓	—	—	—	—	—	—	—	—	—
PXIe-1071	—	✓	—	—	—	—	—	—	—	—
PXIe-1083	—	✓	—	—	—	—	—	—	—	—
PXIe-1073	—	✓	—	—	—	—	—	—	—	—
PXIe-1086DC	—	—	✓	✓	—	—	—	—	—	—
PXIe-1086	—	—	✓	✓	—	—	—	—	—	—
PXIe-1088	—	—	—	—	✓	✓	—	—	—	—
PXIe-1084 Timing and Synchronization (786397-01)	—	—	—	—	—	—	✓	✓	—	—
PXIe-1084	—	—	—	—	—	—	✓	✓	—	—
PXIe-1085	—	—	✓	✓	—	—	—	—	—	—
PXIe-1092 Timing and Synchronization (786991-01)	—	—	—	—	—	—	—	—	✓	✓
PXIe-1095	—	—	—	—	—	—	✓	✓	—	—
PXIe-1095 Timing and Synchronization (785971-01)	—	—	—	—	—	—	✓	✓	—	—



## Thunderbolt 3 Male-to-Male Cable

Part Number	785607-02	785608-02	787580-0R8
Description	Thunderbolt 3 Type-C Cable, Active 40 Gb/S, 3A, 2 m	Thunderbolt 3 Type-C Cable, Passive 20 Gb/S, 5A, 2 m	Thunderbolt 3 Type-C Cable, Passive 40 Gb/S, 5A, 0.8 m
PXie-1090	✓	✓	✓
PXie-1083	✓	✓	✓

## HDMI Trigger Cable

Part Number	148864-01	148864-02	149055-0R2
Description	HDMI Cable for Trigger Routing (1 m)	HDMI Cable for Trigger Routing (2 m)	Chassis Trigger Breakout Cable (0.2 m)
PXie-1084 Timing and Synchronization (786397-01)	✓	✓	✓
PXie-1092 Timing and Synchronization (786991-01)	✓	✓	✓
PXie-1092	✓	✓	✓
PXie-1095	✓	✓	✓
PXie-1095 Timing and Synchronization (785971-01)	✓	✓	✓

## Power Supply Replacement

Part Number	782106-01	782107-01	784057-01	781719-01	786300-01
Description	Replacement Power Supply for NI PXie-1066DC and PXie-1086DC	Replacement Power Supply for NI PXie-1066DC and PXie-1086DC —for EU	Power Supply Filler Panel for PXie-1066DC and PXie-1086DC	Replacement Power Supply for PXie-1085	Upgrade/ Replacement Power Supply for PXie-1092 or PXie-1095
PXie-1086DC	✓	✓	✓	—	—
PXie-1086	✓	✓	✓	—	—
PXie-1085	—	—	—	✓	—
PXie-1092 Timing and Synchronization (786991-01)	—	—	—	—	✓
PXie-1092	—	—	—	—	✓
PXie-1095	—	—	—	—	✓
PXie-1095 Timing and Synchronization (785971-01)	—	—	—	—	✓

## Fan Replacement Kits

Part Number	784854-01	786324-02	786972-01	786324-01
Description	Chassis Fan Replacement Kit for PXIe-1078 and PXIe-1088	Replacement Fan Assembly for NI PXIe-1084	Fan Replacement Kit for PXIe-1092 Chassis	Replacement Fan Assembly for NI PXIe-1095
PXIe-1088	✓	—	—	—
PXIe-1084 Timing and Synchronization (786397-01)	—	✓	—	—
PXIe-1084	—	✓	—	—
PXIe-1092	—	—	✓	—
PXIe-1092 Timing and Synchronization (786991-01)	—	—	✓	—
PXIe-1095	—	—	—	✓
PXIe-1095 Timing and Synchronization (785971-01)	—	—	—	✓

## NI PXI Carrying Case

Part Number	780398-01
Description	PXI Carrying Case for Midsize Chassis (10 Slots or Fewer)
PXIe-1083	✓
PXIe-1073	✓
PXIe-1071	✓
PXIe-1088	✓
PXIe-1092 Timing and Synchronization (786991-01)	✓
PXIe-1092	✓



## PXI Controllers

### With NI PXI controllers, take advantage of:

- The latest high-performance Intel processors, with up to 18 cores available
- OSs: Windows 11, Windows 10, Windows 7, Linux Desktop (RHEL, OpenSUSE, Ubuntu), NI Linux Real-Time Memory and storage up to 512 GB and 64 GB, respectively
- Solid-state drives, Thunderbolt 3, USB 3.0, Gigabit Ethernet, and other peripheral ports

### Key Features:

#### High Performance

NI maintains close partnerships with key processor manufacturers, including Intel and Advanced Micro Devices, so NI controllers feature the latest processors, such as the Intel Atom, Core i7, and Xeon.

#### Durability

NI offers PXI controllers with solid-state drives (SSDs) so that you can test under a wide range of conditions. Controllers with SSDs are designed to operate in extreme shock, high altitude, and random vibration environments.

#### Data Security

The Trusted Platform Module, a secure cryptoprocessor, is a component on select embedded controllers specifically designed to elevate platform security above the capabilities of today's software by providing a protected space for key operations and other security-critical tasks.

## PXI Controller Modules

Selection Guide	Model	Part Number	Controller OS	Hard Drive Memory Size	HDD Removable	Max Controller Bandwidth	Cores	Processor Core	TPM Version	Region
Good, Intel Core i3	PXIe-8822	787881-01	Windows 10 64-bit	512 GB	—	4 GB/s	4	Intel Core i3	2	Rest of the World
		787881-0118	Windows 10 64-bit	512 GB	—	4 GB/s	4	Intel Core i3	2	China
		787881-33	LabVIEW Real-Time (NI Linux Real-Time)	512 GB	—	4 GB/s	4	Intel Core i3	—	—
		788815-01	Windows 11	512 GB	—	4 GB/s	4	Intel Core i3	2	Rest of the World
		788815-0118	Windows 11	512 GB	—	4 GB/s	4	Intel Core i3	2	China
Better, Intel Core i5	PXIe-8842	787882-01	Windows 10 64-bit	512 GB	—	8 GB/s	6	Intel Core i5	2	Rest of the World
		787882-0118	Windows 10 64-bit	512 GB	—	8 GB/s	6	Intel Core i5	2	China
		787882-33	LabVIEW Real-Time (NI Linux Real-Time)	512 GB	—	8 GB/s	6	Intel Core i5	—	—
		788816-01	Windows 11	512 GB	—	8 GB/s	6	Intel Core i5	2	Rest of the World
		788816-0118	No OS	—	—	—	6	—	2	China
Best, Intel Core i7	PXIe-8862	787987-01	Windows 10 64-bit	512 GB	—	16 GB/s	8	Intel Core i7	2	Rest of the World
		787987-0118	Windows 10 64-bit	512 GB	—	16 GB/s	8	Intel Core i7	2	China
		787987-33	LabVIEW Real-Time (NI Linux Real-Time)	512 GB	—	16 GB/s	8	Intel Core i7	—	—
		788817-01	Windows 11	512 GB	—	16 GB/s	8	Intel Core i7	2	Rest of the World
		788817-0118	Windows 11	512 GB	—	16 GB/s	8	Intel Core i7	2	China
		788818-01	Windows 11	960 GB	—	16 GB/s	8	Intel Core i7	2	Rest of the World
		789546-01	Windows 10 64-bit	512 GB	—	16 GB/s	8	Intel Core i7	—	—
Extreme, Server-Grade	PXIe-8881	786636-01	Windows 10 64-bit	512 GB	—	24 GB/s	8	Xeon 8-Core	2	Rest of the World
		786636-0118	Windows 10 64-bit	512 GB	—	24 GB/s	8	Xeon 8-Core	—	China
		787805-01	Windows 10 64-bit	512 GB	—	24 GB/s	8	Xeon 8-Core	—	—
		787805-33	LabVIEW Real-Time (NI Linux Real-Time)	512 GB	—	24 GB/s	8	Xeon 8-Core	—	—
		787806-01	Windows 10 64-bit	512 GB	—	24 GB/s	18	Xeon 18-Core	2	Rest of the World
		787806-0118	Windows 10 64-bit	512 GB	—	24 GB/s	18	Xeon 18-Core	—	China
		787807-01	Windows 10 64-bit	512 GB	—	24 GB/s	4	Xeon Quad-Core	2	Rest of the World
		787807-0118	Windows 10 64-bit	512 GB	—	24 GB/s	4	Xeon Quad-Core	—	China
		789431-01	Windows 11	512 GB	—	24 GB/s	8	Xeon 8-Core	2	Rest of the World
		789431-0118	Windows 11	512 GB	—	24 GB/s	8	Xeon 8-Core	2	China

## PXI Rack-Mount Controller Modules

Model	Part Number	Processor	Controller OS	RAM	Storage	PCI Express	Video	Ports
NI RMC-8356 for PXI Express Control (Windows)	785321-01	Intel Xeon E5620 (2.4G Hz Quad Core)	Windows 10 64-bit	16 GB–64 GB DDR4	1 TB HDD + 3 Additional Bays	3.0 x 16, 1 Slot (for Remote Control)	2 Display Ports, 1 DVI, 1 VGA	2 USB 3.0, 4 USB 2.0, 2 Gigabit Ethernet RJ-45
NI RMC-8354 1U Controller, Core i7-860, 1X 500 GB, Real-Time Software	781650-33	Intel Core i7-860 (2.8 GHz)	LabVIEW Real-Time OS	1 GB (Included)	500 GB	Gen 1 MXI	—	—

## Controller Accessories

### Hard Drives

Hard Drive	1 TB NVMe Solid-State Drive Upgrade For PXIe-8822/8842/8862, M.2, 80 mm	Spare 512 GB NVMe Solid-State Drive for PXIe-8822/8842/8862, M.2, 80 mm	Spare 512 GB NVMe Solid-State Drive, M.2, 80 mm
Part Number	788898-01	788897-01	786775-01
PXIe-8822	✓	✓	—
PXIe-8842	✓	✓	—
PXIe-8862	✓	✓	—
PXIe-8881	—	—	✓

## RAM

RAM	16 GB DDR4 3200 SO-DIMM RAM for PXIe-8822/8842/8862	16 GB DDR4 2666 SO-DIMM RAM, ECC for PXIe-8881	16 GB DDR4 2666 SO-DIMM RAM, ECC for PXIe-8881
Part Number	788899-01	787659-01	787659-01
PXIe-8822 [787881-01]	✓	✓	—
PXIe-8822 [787881-0118]	✓	✓	—
PXIe-8822 [787881-33]	✓	✓	—
PXIe-8822 [788815-01]	✓	✓	—
PXIe-8822 [788815-0118]	✓	✓	—
PXIe-8842 [787882-01]	✓	✓	—
PXIe-8842 [787882-0118]	✓	✓	—
PXIe-8842 [787882-33]	✓	✓	—
PXIe-8842 [788816-01]	✓	✓	—
PXIe-8842 [788816-0118]	✓	✓	—
PXIe-8862 [787987-01]	✓	✓	—
PXIe-8862 [787987-0118]	✓	✓	—
PXIe-8862 [787987-33]	✓	✓	—
PXIe-8862 [788817-01]	✓	✓	—
PXIe-8862 [788817-0118]	✓	✓	—
PXIe-8862 [788818-01]	✓	✓	—
PXIe-8862 [789546-01]	✓	✓	—
PXIe-8881 [786636-01]	—	—	✓
PXIe-8881 [786636-0118]	—	—	✓
PXIe-8881 [787805-01]	—	—	✓
PXIe-8881 [787805-33]	—	—	✓
PXIe-8881 [787807-01]	—	—	✓
PXIe-8881 [787807-0118]	—	—	✓
PXIe-8881 [789431-01]	—	—	✓
PXIe-8881 [789431-0118]	—	—	✓



## PXI Remote Controllers and System Expansion

### Achieve the ultimate flexibility with PXI remote controllers:

- Control a PXI chassis from a desktop PC, laptop, or rack-mount controller
- Create synchronized, data-connected, multichassis PXI systems
- Choose from copper and fiber-optic cable options
- Take advantage of a software-transparent link requiring no programming

### Key Features:

#### Desktop or Rack-Mount PC Control

With a PXI remote control module, a host computer can establish a PCI Express connection to the chassis using a compatible MXI-Express Cable.

#### Multichassis Synchronization

PXI remote control modules can leverage the architecture of the PXI platform to achieve high-accuracy synchronization between modular instruments in separate chassis. By combining NI's timing and synchronization modules with MXI-Express, you can synchronize instruments across multiple chassis with NI-TClk technology deskewing.

#### Flexible Topologies

While a daisy-chaining topology is the most common approach to building multichassis systems, some host interface cards support star topologies so that each chassis can communicate directly with the host.

## PXI Remote Control Modules

Selection Guide	Model	Part Number	Bus Connector	MXI Bandwidth	MXI Communication Level	MXI Ports	Supported Cable Type	Supports Daisy-Chaining
Entry	<b>PXIe-8360</b>	779700-01	—	250 MB/s	MXI-Express x1	1	Copper	—
	<b>PCIe-8363</b>	788814-01	PCI Express		MXI-Express x1	1	Copper	—
	<b>PXIe-8364</b>	781819-01	PXI Express	250 MB/s	MXI-Express x1	—	Copper	—
	<b>PXIe-8374</b>	781820-04	PXI Express	1 GB/s	MXI-Express x4	—	Copper	—
Midrange	<b>PXIe-8381</b>	782362-01	—	4 GB/s	MXI-Express Gen2 x8	1	Copper	—
	<b>PCIe-8382</b>	779933-01	PCI Express	—	MXI-Express Gen2 x8	1	Copper	—
	<b>PCIe-8383</b>	789542-01	PCI Express	—	MXI-Express Gen2 x8	1	Copper	—
	<b>PXIe-8384</b>	782363-01	PXI Express	4 GB/s	MXI-Express Gen2 x8	—	Copper	—
Performance	<b>PXIe-8398</b>	784178-01	—	16 GB/s	MXI-Express Gen3 x16	4	Copper and Fiber-Optic	✓
	<b>PXIe-8399</b>	784180-01	—	16 GB/s	MXI-Express Gen3 x16	8	Copper and Fiber-Optic	✓
	<b>PCIe-8398</b>	784179-01	PCI Express	—	MXI-Express Gen3 x16	1	Copper and Fiber-Optic	—
	<b>PXIe-8394</b>	785157-01	PXI Express	7.9 GB/s	MXI-Express Gen3 x8	—	Copper and Fiber-Optic	—
Thunderbolt	<b>PXIe-8301</b>	785679-01	—	2.3 GB/s	Thunderbolt 3.0	2	Copper	—

## PXI Remote Control Module Accessories

### PXI Remote Control Module Cables

Cable Type	Thunderbolt 3 Type-C Cable, Active 40 GB/S, 3A, 2 m	Thunderbolt 3 Type-C Cable, Passive 20 GB/S, 5A, 2 m	Thunderbolt 3 Type-C Cable, Passive 40 GB/S, 5A, 0.8 m	MXI-Express Cable, Gen 1 x1, Copper, 1 m	MXI-Express Cable, Gen 1 x1, Copper, 3 m
Part Number	785607-02	785608-02	787580-0R8	779500-01	779500-03
PXIe-8301	✓	✓	✓	—	—
PXIe-8360	—	—	—	✓	✓
PCIe-8368	—	—	—	—	✓
PCIe-8382	—	—	—	—	—
PCIe-8383	—	—	—	—	—
PXIe-8381	—	—	—	—	—
PCIe-8398	—	—	—	—	—
PXIe-8398	—	—	—	—	—
PXIe-8399	—	—	—	—	—
PXIe-8374	—	—	—	✓	✓
PXIe-8384	—	—	—	—	—
PXIe-8394	—	—	—	—	—
PXIe-8364	—	—	—	✓	✓



## PXI Remote Control Module Cables (continued)

Cable Type	MXI-Express Cable, Gen 1 x1, Copper, 7 m	MXI-Express Cable, Gen 2 x8, Copper, 1 m	MXI-Express Cable, Gen 2 x8, Copper, 2 m	MXI-Express Cable, Gen 2 x8, Copper, 3 m	MXI-Express Cable, Gen 2 x8, Copper, 5 m
Part Number	779500-07	782317-01	782317-02	782317-03	782317-05
PXIe-8301	—	—	—	—	—
PXIe-8360	✓	—	—	—	—
PCIE-8368	—	—	—	—	—
PCIE-8382	—	✓	✓	✓	✓
PCIE-8383	—	✓	✓	✓	✓
PXIe-8381	—	✓	✓	✓	✓
PCIE-8398	—	—	—	—	—
PXIe-8398	—	—	—	—	—
PXIe-8399	—	—	—	—	—
PXIe-8374	✓	—	—	—	—
PXIe-8384	—	✓	✓	✓	✓
PXIe-8394	—	—	—	—	—
PXIe-8364	✓	—	—	—	—

## PXI Remote Control Module Cables (continued)

Cable Type	MXI-Express Cable, Gen 3 x4, Copper, 3 m	MXI-Express Cable, Gen 3 x8, Copper, 1 m	MXI-Express Cable, Gen 3 x8, Copper, 3 m	MXI-Express Cable, Gen 3 x4, Fiber-Optic, 10 m	MXI-Express Cable, Gen 3 x4, Fiber-Optic, 100 m	MXI-Express Cable, Gen 3 x4, Fiber-Optic, 30 m
Part Number	785549-03	785550-01	785550-03	788302-10	788302-100	788302-30
PXIe-8301	—	—	—	—	—	—
PXIe-8360	—	—	—	—	—	—
PCIE-8368	—	—	—	—	—	—
PCIE-8382	—	—	—	—	—	—
PCIE-8383	—	—	—	—	—	—
PXIe-8381	—	—	—	—	—	—
PCIE-8398	✓	✓	✓	—	—	—
PXIe-8398	✓	✓	✓	✓	✓	✓
PXIe-8399	✓	✓	✓	✓	✓	✓
PXIe-8374	—	—	—	—	—	—
PXIe-8384	—	—	—	—	—	—
PXIe-8394	✓	✓	✓	✓	✓	✓
PXIe-8364	—	—	—	—	—	—

# PXI Instrument Overview



## PXI Oscilloscopes Page 36

- Sample at speeds of up to 12.5 GS/s
- 5 GHz of analog bandwidth
- Numerous triggering modes
- Up to 24-bit resolution



## PXI Digital Multimeters Page 41

- Voltage measurements up to 1,000 VDC
- Current measurements up to 3 A
- Resistance measurements up to 5 G $\Omega$
- Isolated digitizer mode up to 1.8 MS/s



## PXI Waveform Generators Page 43

- Up to two 16-bit channels per module
- 800 MS/s with 20, 40, and 80 MHz bandwidth
- Up to 34 channels to build parallel
- Max  $\pm 12$  V and min  $\pm 7.75$  mV output ranges



## PXI Counter/Timers Page 45

- Up to eight 32-bit counter/timers
- TTL/CMOS-compatible digital I/O
- Up to 80 MHz measure frequency
- On-board high-precision oscillators



## PXI Power Supplies Page 47

- Two isolated, 60 W channels per module
- Hardware timing and triggering
- Output disconnect relays
- Four-wire remote sense



## PXI Switches Page 49

- Electromechanical, reed, solid-state, FET
- Up to 150 V or 2 A
- Up to 544 crosspoints in a single PXI slot
- 1- and 2-wire options



## PXI Source Measure Units (SMU) Page 59

- Up to 24 channels (408 per chassis)
- Up to 200 V and 3 A (10 A pulse)
- Current sensitivity down to 10 fA
- Max power per channel of 40 W (500 W pulse)



## PXI LCR Meter and SMU Page 63

- AC stimulus frequency up to 2 MHz
- AC stimulus amplitude up to 7.07 V<sub>rms</sub>
- DC bias up to  $\pm 40$  V
- Basic impedance accuracy of 0.05%



## PXI Digital Pattern Instruments Page 65

- 32-channel module (up to 512 per chassis)
- 100 MHz vector rate, 39 ps displacement
- Digital voltage of -2 V to 6 V
- Up to 200 Mb/s data rate



## PXI Digital Waveform Instruments Page 67

- Standard TTL/CMOS interface voltages and programmable voltage levels
- 32 bidirectional digital channels
- Advanced waveform sequencing and streaming features



## PXI Electronic Loads Page 70

- Ability to sink up to 300 W of DC power
- Voltage and current measurements with sample rates up to 1.8 MS/s and update rates up to 100 kS/s
- Hardware timing and triggering
- Four-wire remote sense



### PXI High-Speed Serial Page 72

- Up to 48 Xilinx MGT (Multigigabit Transceivers) with line rates up to 28.2 Gb/s
- Various high-speed serial protocols on the user-programmable Xilinx Kintex UltraScale+ or 7 series FPGAs
- High-speed P2P backplane data streaming up to 7 GB/s to host, disk, or other PXI Express modules
- Up to 20 GB onboard DDR3 DRAM



### PXI Timing and Synchronization Page 75

- Generate high-stability PXI system reference clocks and high-resolution sample clocks
- Achieve synchronization over long distance through GPS, IEEE 1588, IRIG-B, or PPS
- Develop advanced timing and sync applications with NI-Sync and NI-TClk software
- Import and export system reference clocks for synchronization between multiple chassis or external devices



### PXI Sound and Vibration Page 77

- Built-in high-pass filtering
- Reliable dynamic signal characterization
- Per-channel, software-selectable AC input coupling
- Per-channel, software-selectable input gain settings



### PXI Signal Conditioning Modules Page 80

- High channel density for conditioned and sensor measurements
- Flexible, synchronized, and accurate measurements
- Isolated measurement options
- Swappable front mount terminal block



### PXI DAQ Page 100

- High resolution
- High-accuracy measurements
- Advanced timing technology
- A family of products built around flexibility



### PXI Reconfigurable I/O (FPGA) Page 85

- Variety of onboard FPGA options
- 12-bit to 18-bit analog input resolution
- Up to 16 analog channels and 96 bidirectional channels
- Up to 1 MS/s analog sample rate



### PXI FlexRIO Page 88

- Analog I/O up to 6.4 GS/s, digital I/O up to 1.25 Gb/s, RF I/O up to 4.4 GHz
- High-performance Xilinx FPGAs with up to 20 GB of onboard DRAM
- Program with LabVIEW FPGA or Xilinx Vivado
- Develop application-specific I/O with FlexRIO Module Development Kit



Recommended software (sold separately):

 LabVIEW

 InstrumentStudio Professional

Additional resources for software development:

C/C++, C#, Python

 InstrumentStudio

 LabWindows/CVI

## PXI Oscilloscopes

Sample at speeds up to 5 GS/s

1.5 GHz of analog bandwidth

Numerous triggering modes

Up to 24-bit resolution

### Key Features:

#### Deep On-Board Memory

PXI oscilloscopes feature deep onboard memory capable of storing multiple acquisitions from single channels or parallel acquisitions from multiple channels on the same device.

#### CableSense™ Technology

CableSense technology can reduce risk of faulty electrical connection by detecting changes from a known, golden setup without having to alter the connections themselves.

#### Automatic Synchronization

The same model scopes will synchronize in a PXI chassis for high-channel scope applications.

## PXI Oscilloscope Modules

Selection Guide	Model	Part Number	Memory Size	CableSense	Channels	Resolution	Bandwidth	Sample Rate	Reconfigurable FPGA
High Performance	PXIe-5160	782621-01	64 MB	—	2	10 Bits	500 MHz	2.5 GS/s	—
		782621-02	2 GB	—	2	10 Bits	500 MHz	2.5 GS/s	—
		782621-03	2 GB	—	4	10 Bits	500 MHz	2.5 GS/s	—
		782621-11	64 MB	✓	2	10 Bits	500 MHz	2.5 GS/s	—
		782621-12	2 GB	✓	2	10 Bits	500 MHz	2.5 GS/s	—
		782621-13	2 GB	✓	4	10 Bits	500 MHz	2.5 GS/s	—
High Performance, High Bandwidth	PXIe-5162	782622-01	64 MB	—	2	10 Bits	1.5 GHz	5 GS/s	—
		782622-05	2 GB	—	2	10 Bits	1.5 GHz	5 GS/s	—
		782622-06	2 GB	—	4	10 Bits	1.5 GHz	5 GS/s	—
		782622-11	64 MB	✓	2	10 Bits	1.5 GHz	5 GS/s	—
		782622-15	2 GB	✓	2	10 Bits	1.5 GHz	5 GS/s	—
		782622-16	2 GB	✓	4	10 Bits	1.5 GHz	5 GS/s	—
High Density with Reconfigurable FPGA	PXIe-5172	784224-01	0.75 GB	—	4	14 Bits	100 MHz	250 MS/s	Kintex-7 325T
		784225-01	1.5 GB	—	8	14 Bits	100 MHz	250 MS/s	Kintex-7 325T
		784226-01	1.5 GB	—	8	14 Bits	100 MHz	250 MS/s	Kintex-7 410T
High Density, Low Voltage Input with Reconfigurable FPGA	PXIe-5170	783690-01	0.75 GB	—	4	14 Bits	100 MHz	250 MS/s	Kintex-7 325T
		783691-01	1.5 GB	—	8	14 Bits	100 MHz	250 MS/s	Kintex-7 325T
	PXIe-5171	783692-01	1.5 GB	—	8	14 Bits	250 MHz	250 MS/s	Kintex-7 410T
High Density, Low Cost	PXIe-5105	783590-01	16 MB	—	8	12 Bits	60 MHz	60 MS/s	—
		783590-02	128 MB	—	8	12 Bits	60 MHz	60 MS/s	—
		783590-03	512 MB	—	8	12 Bits	60 MHz	60 MS/s	—
Low Cost	PXIe-5114	783591-01	8 MB	—	2	8 Bits	125 MHz	250 MS/s	—
		783591-02	64 MB/ch	—	2	8 Bits	125 MHz	250 MS/s	—
		783591-03	256 MB/ch	—	2	8 Bits	125 MHz	250 MS/s	—
Low Cost, Lowest Bandwidth	PXIe-5110	785767-01	64 MB	—	2	8 Bits	100 MHz	1 GS/s	—
		785768-01	512 MB	—	2	8 Bits	100 MHz	1 GS/s	—
		785768-11	512 MB	✓	2	8 Bits	100 MHz	1 GS/s	—
Low Cost, Medium Bandwidth	PXIe-5111	785769-01	64 MB	—	2	8 Bits	350 MHz	3 GS/s	—
		785769-11	64 MB	✓	2	8 Bits	350 MHz	3 GS/s	—
		785770-01	512 MB	—	2	8 Bits	350 MHz	3 GS/s	—
		785770-11	512 MB	✓	2	8 Bits	350 MHz	3 GS/s	—
Low Cost, Highest Bandwidth	PXIe-5113	786375-01	64 MB	—	2	8 Bits	500 MHz	3 GS/s	—
		786375-11	64 MB	✓	2	8 Bits	500 MHz	3 GS/s	—
		786405-01	512 MB	—	2	8 Bits	500 MHz	3 GS/s	—
		786405-11	512 MB	✓	2	8 Bits	500 MHz	3 GS/s	—
High-Voltage Input	PXIe-5163	785182-01	512 MB	—	2	14 Bits	200 MHz	1 GS/s	—
High Resolution	PXIe-5122	779967-01	8 MB/ch	—	2	14 Bits	100 MHz	100 MS/s	—
		779967-02	64 MB/ch	—	2	14 Bits	100 MHz	100 MS/s	—
		779967-03	256 MB/ch	—	2	14 Bits	100 MHz	100 MS/s	—
Flexible Resolution	PXI-5922	779153-01	8 MB/ch	—	2	24 Bits	6 MHz	15 MS/s	—
		779153-02	32 MB/ch	—	2	24 Bits	6 MHz	15 MS/s	—
		779153-03	256 MB/ch	—	2	24 Bits	6 MHz	15 MS/s	—
Highest Voltage Input	PXIe-5164	784183-01	1.5 GB	—	2	14 Bits	400 MHz	1 GS/s	Kintex-7 410T

## PXI Oscilloscope Accessories

### Single-Ended Passive Probes

Single-Ended Passive Probes	SP500X Single-Ended Passive Probe, 500 MHz, 300 VDC, 10:1 Attenuation	SP500C Single-Ended Passive Probe, 500 MHz, 300 VDC, 100:1 Attenuation	CP500X Single-Ended Coaxial Passive Probe, 500 MHz, 60 VDC, 10:1 Attenuation	CP400X Single-Ended Coaxial Passive Probe, 400 MHz, 60 VDC, 10:1 Attenuation
Part Number	783629-01	783630-01	784253-01	784254-01
PXIe-5105	—	—	—	—
PXIe-5110	✓	✓	✓	✓
PXIe-5111	✓	✓	✓	✓
PXIe-5113	✓	✓	✓	✓
PXIe-5114	—	—	—	✓
PXIe-5122	—	—	—	✓
PXIe-5160	✓	✓	✓	✓
PXIe-5162	✓	✓	✓	✓
PXIe-5163	✓	✓	✓	✓
PXIe-5164	✓	✓	✓	✓
PXIe-5170	—	—	—	—
PXIe-5171	—	—	—	—
PXIe-5172	✓*	✓*	✓*	✓*
PXI-5922	—	—	—	—

\* Requires SMB-to-BNC Adapter

### Active Probes

Active Probes	SA1000X Single-Ended Active Probe, 1 GHz, 20 VDC, 10:1 Attenuation	SA1500X Single-Ended Active Probe, 1.5 GHz, 20 VDC, 10:1 Attenuation	SA2500X Single-Ended Active Oscilloscope Probe, 2.5 GHz
Part Number	784255-01	784256-01	784257-01
PXIe-5105	✓	✓	✓
PXIe-5110	✓	✓	✓
PXIe-5111	✓	✓	✓
PXIe-5113	✓	✓	✓
PXIe-5114	✓	✓	✓
PXIe-5122	✓	✓	✓
PXIe-5160	✓	✓	✓
PXIe-5162	✓	✓	✓
PXIe-5163	✓	✓	✓
PXIe-5164	✓	✓	✓
PXIe-5170	✓	✓	✓
PXIe-5171	✓	✓	✓
PXIe-5172	✓	✓	✓
PXI-5922	✓	✓	✓

## Current Probes

Current Probes	CC0550X Hioki Current Probe, 5 Arms, 50 MHz	CC05120X Hioki Current Probe, 5 Arms, 120 MHz	CC3050X Hioki Current Probe, 30 Arms, 50 MHz	CC30100X Hioki Current Probe, 30 Arms, 100 MHz	CC15010X Hioki Current Probe, 150 A, 10 MHz	CC5002X Hioki Current Probe, 500 A, 2 MHz
Part Number	786846-01	786847-01	785561-01	785562-01	786849-01	786848-01
PXIe-5105	✓	✓	✓	✓	✓	✓
PXIe-5110	✓	✓	✓	✓	✓	✓
PXIe-5111	✓	✓	✓	✓	✓	✓
PXIe-5113	✓	✓	✓	✓	✓	✓
PXIe-5114	✓	✓	✓	✓	✓	✓
PXIe-5122	✓	✓	✓	✓	✓	✓
PXIe-5160	✓	✓	✓	✓	✓	✓
PXIe-5162	✓	✓	✓	✓	✓	✓
PXIe-5163	✓	✓	✓	✓	✓	✓
PXIe-5164	✓	✓	✓	✓	✓	✓
PXIe-5170	—	—	—	—	—	—
PXIe-5171	—	—	—	—	—	—
PXIe-5172	✓	✓	✓	✓	✓	✓
PXI-5922	✓	✓	✓	✓	✓	✓

## Cables

Description	BNC TO BNC Cable, 50 $\Omega$ , 0.9 m	HD BNC Male to BNC Female Cable, 50 $\Omega$ , 20 cm	SMA Male Plug X SMA Male Plug (Maxi-Flex) 5 in.	Cable Assy, SMA to SMA, Coax, RG-402, 50 $\Omega$ , 1 m
Part Number	781887-01	787230-0R2	763443-01	763444-01
PXIe-5105	—	—	—	—
PXIe-5110	✓	✓	—	—
PXIe-5111	✓	✓	—	—
PXIe-5113	✓	✓	—	—
PXIe-5114	✓	✓	—	—
PXIe-5122	✓	✓	—	—
PXIe-5160	✓	✓	—	—
PXIe-5162	✓	✓	—	—
PXIe-5163	✓	✓	—	—
PXIe-5164	✓	✓	—	—
PXIe-5170	—	—	✓	✓
PXIe-5171	—	—	✓	✓
PXIe-5172	—	—	—	—
PXI-5922	✓	✓	—	—

## Cables (continued)

Description	SMA Male to SMA Male Cable, 50 $\Omega$ , 38.1 cm	1-Pin BNC (Male or Female) to 1-Pin SMB Female, 50 $\Omega$ Coaxial Cable	1-Pin SMB (Female) to 1-Pin BNC (Male or Female), 50 $\Omega$ Coaxial Cable, 2 ft.	1-Pin SMB (Female) to 1-Pin BNC (Male or Female), 50 $\Omega$ Coaxial Cable, 1 m
Part Number	781845-01	189425-0R6	763389-01	763405-01
PXIe-5105	—	—	—	—
PXIe-5110	—	—	✓	✓
PXIe-5111	—	—	✓	✓
PXIe-5113	—	—	✓	✓
PXIe-5114	—	—	✓	✓
PXIe-5122	—	—	✓	✓
PXIe-5160	—	—	✓	✓
PXIe-5162	—	—	✓	✓
PXIe-5163	—	—	✓	✓
PXIe-5164	—	—	✓	✓
PXIe-5170	✓	✓	—	—
PXIe-5171	✓	✓	—	—
PXIe-5172	—	—	✓	✓
PXI-5922	—	—	✓	✓

## Probe Compensation Tabs

Probe Compensation Tabs	SMB Female to Probe Compensation Tabs, 8 cm
Part Number	786983-01
PXIe-5105	✓
PXIe-5110	—
PXIe-5111	—
PXIe-5113	—
PXIe-5114	—
PXIe-5122	—
PXIe-5160	✓
PXIe-5162	✓
PXIe-5163	—
PXIe-5164	—
PXIe-5170	—
PXIe-5171	—
PXIe-5172	—
PXI-5922	—







Recommended software (sold separately):

-  LabVIEW
-  InstrumentStudio Professional

Additional resources for software development:

- C/C++, C#, Python
-  InstrumentStudio
-  LabWindows/CVI

## PXI Digital Multimeters

- Voltage measurements up to 1,000 VDC
- Current measurements up to 3 A
- Resistance measurements up to 5 GΩ
- Isolated digitizer mode up to 1.8 MS/s

### Key Features:

#### Most Accurate 7.5-Digit DMM

With 26 bits of resolution and high stability, NI digital multimeters (DMMs) outperform traditional box DMMs.

#### Customizable Settings

With NI DMMs, you programmatically can customize measurement settings to prioritize speed or accuracy.

#### Isolated Digitizer Mode

Isolated, high-voltage digitizer mode means sample rates up to 1.8 MS/s—36X faster than traditional DMMs.

### PXI Digital Multimeter Modules

Selection Guide	Model	Part Number	Basic DC Voltage Accuracy	Bus Connector	DC Current Range	DC Voltage Range	Digits of Resolution	L&C Measurements	Max Sample Rate
LCR Meter Functionality	<a href="#">PXIe-4082</a>	783131-01	25 ppm	PXI Express	-1 A to 1 A	-300 V to 300 V	6.5	✓	1.8 MS/s
Highest Resolution and Voltage Range	<a href="#">PXIe-4081</a>	783130-01	12 ppm	PXI Express	-3 A to 3 A	-1000 V to 1000 V	6.5	—	1.8 MS/s
General Purpose	<a href="#">PXIe-4080</a>	783129-01	25 ppm	PXI Express	-1 A to 1 A	-300 V to 300 V	7.5	—	1.8 MS/s
Lowest Cost	<a href="#">PXI-4065</a>	780011-01	90 ppm	PXI Hybrid	-3 A to 3 A	-300 V to 300 V	6.5	—	3 kS/s

## PXI Digital Multimeter Accessories

### Probes

Probe	P-1 DMM Test Probes	P-2 Probe Set	P-3 Probe Set, Banana Plug to Bare Wire DMM Cable, 1 m	Low-Leakage, Low-Thermal-EMF Cable Set (60 V Max)	Low-Leakage, Low-Thermal-EMF Connectivity Kit for Custom Cables (60 V Max)	Digital Multimeter Trigger Cable, 9 pin DIN to 2 BNC, 0.5 m
Part Number	761000-01	184698-01	185692-01	779410-01	779499-01	184931-0R5
PXIe-4082	✓	✓	✓	✓	✓	—
PXIe-4081	✓	✓	✓	✓	✓	—
PXIe-4080	✓	✓	✓	✓	✓	—
PXI-4065	✓	✓	✓	✓	✓	✓

### Connector Blocks

Connector Block	200 mA Current Shunt	10 A Current Shunt
Part Number	777488-01	777488-02
PXIe-4082	✓	✓
PXIe-4081	✓	✓
PXIe-4080	✓	✓
PXI-4065	✓	✓



Recommended software (sold separately):

 LabVIEW

 InstrumentStudio Professional

Additional resources for software development:

C/C++, C#, Python

 InstrumentStudio

 LabWindows/CVI

## PXI Waveform Generator

- Up to two 16-bit channels
- 800 MS/s update rate with 20, 40, and 80 MHz bandwidth options
- Up to 34 channels in parallel per chassis
- Maximum  $\pm 12$  V and minimum  $\pm 7.75$  mV output ranges

### Key Features:

#### Waveform Streaming

A PXI waveform generator can stream hundreds of megasamples per second to instrument memory.

#### Digital Filtering

PXI waveform generators feature digital filtering designed to remove unwanted frequency images from the generated signal in arbitrary generation mode.

#### Waveform Scripting

Define standard and arbitrary waveforms that can be looped and burst using scripts.

### PXI Waveform Generator Modules

Selection Guide	Model	Part Number	Memory Size	Channels	Resolution	Bandwidth	Upload Rate
Lowest Bandwidth	PXIe-5413	784181-01	512 MB	1	16	20 MHz	800 MS/s
		785114-01	1 GB	2	16	20 MHz	800 MS/s
Medium Bandwidth	PXIe-5423	785115-01	512 MB	1	16	40 MHz	800 MS/s
		785116-01	1 GB	2	16	40 MHz	800 MS/s
Highest Bandwidth	PXIe-5433	785117-01	512 MB	1	16	80 MHz	800 MS/s
		785118-01	1 GB	2	16	80 MHz	800 MS/s
Clock Generator	PXI-5404	778577-02	8 MB	1	12	100 MHz	300 MS/s

## PXI Waveform Generator Accessories

### Cables

Description	Double-Shielded SMB to BNC Male Coax Cable, 50 $\Omega$ , 1 m	SMB Plug to SMB Plug Coax Cable, 50 $\Omega$ , 1 m, Qty 1	SMB Female to BNC Male Coax Cable, 1 m, Qty 1	SMA Male to SMA Male Cable, 50 $\Omega$ , 1 m	SMA Male to SMA Male Cable, 50 $\Omega$ , 30 cm	SMA Male to SMA Male Cable, 50 $\Omega$ , 38.1 cm
Part Number	778827-01	188859-01	763405-01	781845-01	781846-01	763444-01
PXIe-5413	—	—	—	✓	✓	✓
PXIe-5423	—	—	—	✓	✓	✓
PXIe-5433	—	—	—	✓	✓	✓
PXI-5404	✓	✓	✓	—	—	—



Recommended software (sold separately):

 LabVIEW

Additional resources for software development:

C/C++, C#, Python,

 LabWindows/CVI

## PXI Counter/Timers

- Up to eight 32-bit counter/timers
- Up to 80 MHz measure frequency
- TTL/CMOS-compatible digital I/O
- Onboard high-precision oscillators

### Key Features:

#### Multiple Counter/Timers:

These devices feature up to eight 32-bit counter/timers. These modules are suitable for a wide array of applications such as automotive/aerospace, industrial/motion control, and manufacturing test.

#### Versatile Measurement and Generation Capabilities:

PXI counter/timer modules perform encoder position measurement, event counting, period measurement, pulse-width measurement, pulse generation, pulse-train generation, and frequency measurement.

#### High Precision and Accuracy:

The PXIe-6614 has an onboard high-precision oscillator for highly accurate and precise measurement over longer periods of time because of the oven-controlled crystal oscillator (OCXO).

### PXI Counter/Timers Modules

Category	Model	Part Number	Counters/Timers	Measure Frequency	Onboard High-Precision Oscillator
High Voltage Option	<b>PXI-6624</b>	778975-01	8	400 MHz	—
Lowest Cost	<b>PXIe-6612</b>	782352-01	8	80 MHz	—
Onboard High-Precision Oscillator	<b>PXIe-6614</b>	782353-01	8	80 MHz	✓

## PXI Counter/Timers Accessories

### Connector Block

Connector Block	BNC-2121	CB-68LP Connector Block	CB-68LPR I/O Connector Block	SCB-68A Shielded Connector Block	TBX-68 Connector Block	SCB-100A Noise-Rejecting, Shielded I/O Connector Block	CB-100 I/O Kit, Din Rail/Panel/Desktop, 50-Pin Connector Blocks, R1005050 Cable, 1 m
Part Number	778289-01	777145-01	777145-02	782536-01	777141-01	785024-01	777812-01
PXIe-6612	✓	✓	✓	✓	✓	—	—
PXIe-6614	✓	✓	✓	✓	✓	—	—
PXI-6624	—	—	—	—	—	✓	✓

### Cables

Cables	Cable Assembly, 2 X 100-Pos .050 Series D-Type, Shielded, Flex Motion, Type SH100M-100M Flex, 1 m	Cable Assembly, 2 X 100-Pos .050 Series D-Type, Shielded, Flex Motion, Type Sh100M-100M Flex, 2 M (4150-0008)	Cable Assembly Kit, 68-68, SCSI-II, Idc, Type R6868	R6868 Low-Cost Unshielded Ribbon Cable, 0.25 m
Part Number	185095-01	185095-02	182482-01	182482-0R25
PXIe-6612	—	—	✓	✓
PXIe-6614	—	—	✓	✓
PXI-6624	✓	✓	—	—

### Cables (continued)

Cables	SH68-68-D1 Shielded Cable, 2 m	SH68-68-D1 Shielded Cable, 5 m	SH68-68-D1 Shielded Cable, 0.4 m	Cable Assy, Type SH6868-D1, 10 m	Cable Assy, Type SH6868-D1, 1m
Part Number	183432-02	183432-05	183432-0R4	183432-10	183432-01
PXIe-6612	✓	✓	✓	✓	✓
PXIe-6614	✓	✓	✓	✓	✓
PXI-6624	—	—	—	—	—



Recommended software (sold separately):

 LabVIEW

 InstrumentStudio Professional

Additional resources for software development:

C/C++, C#, Python

 InstrumentStudio

 LabWindows/CVI

## PXI Power Supplies

Ability to source up to 300 W of DC power

Voltage and current measurements with sample rates up to 1.8 MS/s and update rates up to 100 kS/s

4-wire remote-sense hardware timing and triggering

### Key Features:

#### Source and Measure Faster

You can power your device under test with up to 300 W of DC power, all while taking current and voltage measurements up to 1.8 MS/s to capture the dynamic signal performance. Additionally, high-speed data converters offer update rates up to 100 kS/s for creating dynamic sequences.

#### Increase Measurement Accuracy

You can use multiple measurement ranges in certain PXI power supplies for both voltage and current to enhance measurement accuracy and reduce quantization noise. With this feature, you can achieve higher accuracy for both large and small signals, surpassing what you could do with one range.

#### Tune the Transient Response

You can use NI SourceAdapt technology to optimize system stability and minimize transient response times for a given load with your PXI Programmable Power Supply. With NI SourceAdapt technology, you can test faster without potentially damaging your device.

### PXI Power Supply Modules

Selection Guide	Model	Part Number	Channels	Maximum Voltage (V)	Maximum Current (A)	Maximum Power Per Channel (W)	Maximum Voltage Measurement Resolution	Maximum Current Measurement Resolution	SourceAdapt	Auxiliary Power Supply
Most Channels	<a href="#">PXI-4110</a>	779647-11	3	±20	1	20	0.06 mV	0.20 µA	—	Included with Kit
Highest Voltage	<a href="#">PXIe-4112</a>	782857-01	2	+60	1	60	17 mV	274 µA	—	Included with Kit
General Purpose	<a href="#">PXIe-4113</a>	782857-02	2	+10	6	60	3 mV	2 mA	—	Included with Kit
Highest Power	<a href="#">PXIe-4151</a>	788176-02	1	+20	25*	300	1 µV	10 nA	✓	Not Included

\*Requires a 58 W or greater chassis to source more than 22 A

## PXI Power Supply Accessories

### Auxiliary Power Supplies and Cables

Auxiliary Power Supply or Cable	APS-4100 Auxiliary Power Source for NI DC Power Supplies*	Replacement Auxiliary Power Supply Module for NI PXIe-4112/13*	APS-4158, 8-Channel Auxiliary Power Supply, 1,200 W, 48 V	APS-4159, 8-Channel Auxiliary Power Supply, 2,400 W, 48 V	Auxiliary Power Cable for APS-415x, 0.5 m	Auxiliary Power Cable for APS-415x, 1 m
Part Number	779671-01	782888-01	788201-01	788201-02	788199-0R5	788199-01
PXI-4110	✓	—	—	—	—	—
PXIe-4112	—	✓	—	—	—	—
PXIe-4113	—	✓	—	—	—	—
PXIe-4151	—	—	✓	✓	✓ **	✓ **

\*Replacement/extra

\*\*Must purchase 1x auxiliary cable option per PXIe-4151

### Connectors and Connector Kits

Connectors and Connector Kits	Screw Terminal Connector Kit for PXI-4130 SMU***	Screw Terminal Connector Kit for PXIe-4112/3 Power Supplies***	Connector Kit for PXIe-4150/1 Power Supplies and PXIe-4051 Electronic Load***
Part Number	780557-01	782887-01	788197-01
PXI-4110	✓	—	—
PXIe-4112	—	✓	—
PXIe-4113	—	✓	—
PXIe-4151	—	—	✓

\*\*\*Replacement/extra

### Mounting Kits

Mounting Kit	Rack-Mount Kit for APS-4158/9 Auxiliary Power Supplies
Part Number	786340-01
APS-4158	✓
APS-4159	✓



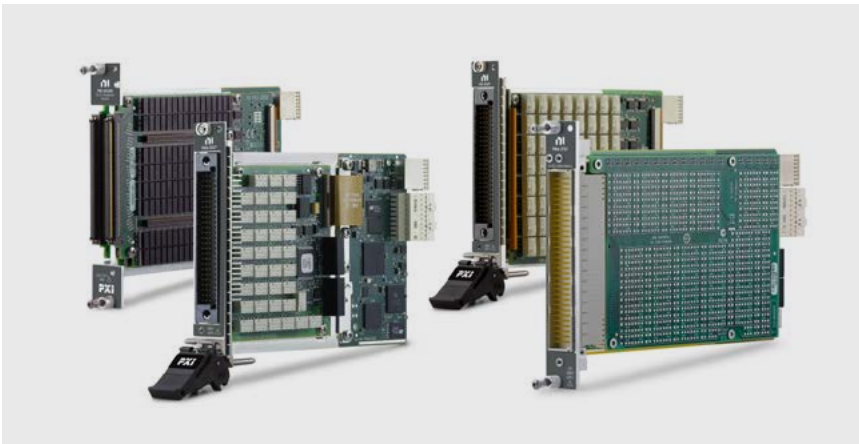

Recommended software (sold separately):

 LabVIEW

 Switch Executive

Additional resources for software development:

C/C++, C#, Python

 LabWindows/CVI

## PXI Switches

100+ different switching topologies

Up to 600 V and 40 A

Bandwidth up to 40 GHz

Up to 544 matrix crosspoints

1- wire, 2- wire, and 4-wire options

Software selectable topologies offer flexibility

### Key Features:

#### PXI Switch Expansion

Physically combine multiple PXI switches to create a single, larger switch by either joining the rows/columns of PXI matrices or by joining the COMs of PXI multiplexers.

#### Synchronize with Instruments

Perform hardware handshaking to synchronize a PXI switch with another PXI instrument, removing the software overhead and bus latency.

#### Switch Executive Software

Utilize this application software for intelligent switch management and routing that accelerates development and simplifies maintenance of complex switch systems.

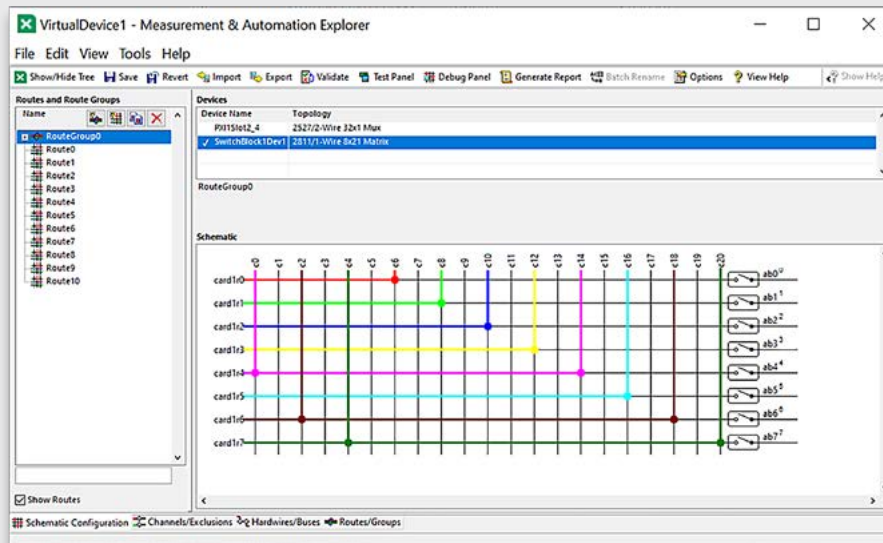

## NI Switch Executive Software

While the NI-SWITCH driver provides all the low-level functionality required to program switch actions, Switch Executive is application software for intelligent switch management and routing that accelerates development and simplifies maintenance of complex switch systems. The point-and-click graphical configuration and automatic routing capabilities make it easy to design your switch system. Using intuitive channel aliases and route names keeps your system documented for future modifications. Save time and increase test code reuse by integrating your system with NI TestStand, LabVIEW, LabWindows/CVI, and NI Measurement Studio™ software.

### With Switch Executive, you can:

- Graphically configure routes and route groups
- Develop reusable switching code and integrate it into NI TestStand or NI LabVIEW
- Automatically route signals between switch endpoints
- Scale switch configuration using Microsoft Excel
- Maintain switch configuration using route validation, reporting, and debugging features

## PXI Switches Modules

### General Purpose Switches

Selection Guide	Model	Part Number	Max Voltage (DC V)	Max Voltage (AC V)	Max Current (Switching)	Max Current (Carry)	Relay Type	Bandwidth
General-Purpose Switches	PXI-2520	778572-20	150	150	2	2	EMR	51 MHz
	PXI-2522	778572-22	100	100	2	2	EMR	36 MHz
	PXI-2527	778572-27	150	150	2	1	EMR	10MHz
	PXI-2529	778739-01	150	150	5	5	EMR	10MHz
	PXI-2564	778572-64	125	250	5	5	EMR	10 MHz
	PXI-2566	778573-66	150	125	5	5	EMR	10 MHz
	PXI-2567	778572-67	150	150	2	2	—	20 MHz
	PXI-2568	778572-68	100	100	1	1	EMR	40 MHz
	PXI-2569	778572-69	100	100	1	1	EMR	40 MHz
	PXI-2571	778572-71	100	100	1	1	EMR	8 MHz
	PXI-2586	778572-86	300	300	12	12	EMR	20 MHz
	PXIe-2569	780587-69	100	100	1	1	EMR	8 MHz

### Matrix and Multiplexer Switches

Selection Guide	Model	Part Number	Max Voltage (DC V)	Max Voltage (AC V)	Max Current (Switching)	Max Current (Carry)	Relay Type	Bandwidth
Matrix and Multiplexer Switches	PXI-2503	777697-01	60	30	1	1	EMR	10 MHz
	PXI-2530B	778572-30	60	30	0.4	0.4	Reed	3 MHz
	PXI-2532B	782383-01	100	100	0.5	0.5	Reed	25 MHz
	PXIe-2529	780587-29	100	100	1	1	EMR	40 MHz
	PXIe-2737	782835-37	100	100	2	2	EMR	10 MHz
	PXI-2575	778572-75	100	100	1	1	EMR	10 MHz
	PXI-2576	778572-76	150	150	2	2	EMR	10 MHz
	PXIe-2525	780587-25	150	150	2	2	EMR	10 MHz
	PXIe-2527	780587-27	150	150	2	1	EMR	10 MHz
	PXIe-2532B	782384-01	100	100	0.5	0.5	EMR	25 MHz
	PXIe-2575	780587-75	100	100	1	1	EMR	10 MHz
	PXIe-2727	781986-27	60	30	0.3	0.3	EMR	—

### RF Switches

Selection Guide	Model	Part Number	Max Voltage (DC V)	Max Voltage (AC V)	Max Current (Switching)	Max Current (Carry)	Relay Type	Bandwidth
RF Switches	PXI-2547	778572-47	30	30	0.5	0.5	EMR	2.7 GHz
	PXI-2594	778572-94	30	30	0.5	0.5	EMR	2.5 GHz
	PXI-2596	778572-96	—	90	—	1.73	EMR	26.5 GHz
	PXI-2599	778572-99	—	90	—	1.73	EMR	26.5 GHz
	PXIe-2541	780587-41	60	42	0.5	0.5	Reed	300 MHz
	PXIe-2593	780587-93	150	150	0.5	0.5	EMR	750 MHz
	PXIe-2748	780587-48	30	30	0.5	0.5	EMR	3 GHz

## SwitchBlock Modules and Carrier Modules

Selection Guide	Model	Part Number	Max Voltage (DC V)	Max Voltage (AC V)	Max Current (Switching)	Max Current (Carry)	Relay Type	Bandwidth
SwitchBlock PXI Carrier Module	<b>PXI-2800</b>	781420-00	150	150	2	2	—	—
SwitchBlock Modules	<b>SWB-2810</b>	781420-10	150	0	1	1	Reed	10 MHz
	<b>SWB-2810</b>	781421-10	150	0	1	1	Reed	10 MHz
	<b>SWB-2816</b>	781420-16	100	70	0.25	0.3	Reed	8 MHz
	<b>SWB-2816</b>	781421-16	100	70	0.25	0.3	Reed	8 MHz
	<b>SWB-2834</b>	781420-34	100	0	2	2	EMR	10 MHz
	<b>SWB-2834</b>	781421-34	100	0	2	2	EMR	10 MHz

## General-Purpose Switch Accessories

### General-Purpose Switch Accessories

Description	160 Pin DIN to Bare Wire Cable for PXI Switches, 1 m	160 Pin DIN to 160 Pin DIN Cable for PXI Switches, 1 m	160 Pin DIN to 4 D-SUB Cable for PXI Switches, 1 m	NI TBX-50B, 50 Pin D-SUB Screw Terminal Block	Cable for PXI-2520 (160-Pin DIN to 160-Pin DIN)	Cable for PXI-2510 (160-Pin DIN to Bare Wire)
Part Number	782417-01	782417-02	782417-03	782866-01	781090-02	781090-03
PXI-2520	✓	✓	✓	✓	✓	✓
PXI-2522	✓	✓	✓	✓	✓	✓
PXI-2527	—	—	—	—	—	—
PXI-2529	—	—	—	—	—	—
PXI-2564	—	—	—	—	—	—
PXI-2566	—	—	—	—	—	—
PXI-2567	—	—	—	—	—	—
PXI-2568	—	—	—	—	—	—
PXI-2569	—	—	—	—	—	—
PXI-2571	—	—	—	—	—	—
PXI-2586	✓	✓	—	—	—	—
PXI-2576	—	—	—	—	—	—
PXIe-2525	✓	✓	✓	✓	✓	✓
PXIe-2527	—	—	—	—	—	—
PXIe-2529	—	—	—	—	—	—
PXIe-2569	—	—	—	—	—	—

## General-Purpose Switch Accessories (continued)

Description	Relay Replacement Kit for IM42GR Relays (Qty: 10)	NI TB-2636 Terminal Block for NI PXI-2529 4 X 32 (2-Wire) Matrix	NI TB-2635, Terminal Block for NI PXI-2529 as 8X16 Matrix	NI TB-2634, Terminal Block for NI PXI-2529 as 4X32 Matrix	37-Pin Female-to-Female D-SUB Cable for NI PXI-2564 1 m	D-SUB, 62/57Pos, Backshell and Connector Kit
Part Number	779356-01	196762-01	778839-01	778840-01	779955-01	778720-01
PXI-2520	—	—	—	—	—	—
PXI-2522	—	—	—	—	—	—
PXI-2527	✓	—	—	—	—	—
PXI-2529	—	✓	✓	✓	—	—
PXI-2564	—	—	—	—	✓	—
PXI-2566	—	—	—	—	—	✓
PXI-2567	—	—	—	—	—	—
PXI-2568	—	—	—	—	—	—
PXI-2569	—	—	—	—	—	—
PXI-2571	—	—	—	—	—	—
PXI-2586	—	—	—	—	—	—
PXI-2576	—	—	—	—	—	—
PXIe-2525	—	—	—	—	—	—
PXIe-2527	✓	—	—	—	—	—
PXIe-2529	—	✓	✓	✓	—	—
PXIe-2569	—	—	—	—	—	—

## General-Purpose Switch Accessories (continued)

Description	62-Pin Female-to-Female Shielded D-SUB Cable for NI PXI-2568	NI TBX-62 62-Pin D-SUB Screw Terminal Block	NI TB-2666 Terminal Block	LFH200 to 4X50-Pin D-SUB Switch Cable (Ch-Ch Twisted), 60 VDC, 1 m	LFH200 to 4X50-Pin D-SUB Switch Cable (Ch-Com Twisted), 60 VDC, 2 m	NI TBX-50, 50 Pin D-SUB Screw Terminal Block
Part Number	779956-01	779957-01	778717-66	779038-03	783139-02	779305-01
PXI-2520	—	—	—	—	—	—
PXI-2522	—	—	—	—	—	—
PXI-2527	—	—	—	—	—	—
PXI-2529	—	—	—	—	—	—
PXI-2564	—	—	—	—	—	—
PXI-2566	—	—	—	—	—	—
PXI-2567	—	—	—	—	—	—
PXI-2568	✓	✓	—	—	—	—
PXI-2569	—	—	✓	✓	✓	—
PXI-2571	—	—	—	✓	✓	—
PXI-2586	—	—	—	—	—	—
PXI-2576	—	—	—	—	—	✓
PXIe-2525	—	—	—	—	—	—
PXIe-2527	—	—	—	—	—	—
PXIe-2529	—	—	—	—	—	—
PXIe-2569	—	—	✓	✓	✓	—

## General-Purpose Switch Accessories (continued)

Description	NI TB-2676 Terminal Block for NI PXI-2576	Ribbon Cable Kit for NI TB-2676 Terminal Block	LFH160 to 50-Pin D-SUB	Cable for NI PXI-2585 and NI PXI-2586 (GMCT20-GMCT20)	Cable for NI PXI-2585 and NI PXI-2586 (GMCT20-Bare Wire)
Part Number	779535-01	779669-01	780009-01	781256-01	781257-01
PXI-2520	—	—	—	—	—
PXI-2522	—	—	—	—	—
PXI-2527	—	—	—	—	—
PXI-2529	—	—	—	—	—
PXI-2564	—	—	—	—	—
PXI-2566	—	—	—	—	—
PXI-2567	—	—	—	—	—
PXI-2568	—	—	—	—	—
PXI-2569	—	—	—	—	—
PXI-2571	—	—	—	—	—
PXI-2586	—	—	—	✓	✓
PXI-2576	✓	✓	✓	—	—
PXIe-2525	—	—	—	—	—
PXIe-2527	—	—	—	—	—
PXIe-2529	—	—	—	—	—
PXIe-2569	—	—	—	—	—

## Matrix Switches

### Matrix Switch Accessories

Description	NI TB-2630B, Terminal Block for NI PXI-2530B as Multiplexer	NI TB-2631B, Term Block for NI PXI-2530B, 4X32 1W or 4X16 2W Matrix	NI TB-2632B, Terminal Block for NI PXI-2530B as 8X16 1W Matrix	LFH160 to 50-Pin D-SUB for NI PXI-2530B	Cable for PXI-2510 (160-Pin DIN to 160-Pin DIN)	Cable for PXI-2510 (160-Pin DIN to Bare Wire)
Part Number	781687-01	781688-01	781689-01	781692-01	781090-02	781090-03
PXI-2503	—	—	—	—	—	—
PXI-2530B	✓	✓	✓	✓	—	—
PXI-2532B	—	—	—	—	—	—
PXIe-2529	—	—	—	—	—	—
PXIe-2737	—	—	—	—	✓	✓
PXIe-2530B	✓	✓	✓	✓	—	—
PXIe-2532B	—	—	—	—	—	—

## Matrix Switch Accessories (continued)

Description	160 Pin DIN to Bare Wire Cable for PXI Switches, 1 m	160 Pin DIN to 160 Pin DIN Cable for PXI Switches, 1 m	160 Pin DIN to 4 D-SUB Cable for PXI Switches, 1 m	NI TB-2636 Terminal Block for NI PXI-2529 4 X 32 (2-Wire) Matrix	NI TB-2635, Terminal Block for NI PXI-2529 as 8X16 Matrix	NI TB-2634, Terminal Block for NI PXI-2529 as 4X32 Matrix
Part Number	782417-01	782417-02	782417-03	196762-01	778839-01	778840-01
PXI-2503	—	—	—	—	—	—
PXI-2530B	—	—	—	—	—	—
PXI-2532B	—	—	—	—	—	—
PXIe-2529	—	—	—	✓	✓	✓
PXIe-2737	✓	✓	✓	—	—	—
PXIe-2530B	—	—	—	—	—	—
PXIe-2532B	—	—	—	—	—	—

## Matrix Switch Accessories (continued)

Description	Matrix Terminal Block and Analog Bus Plug Kit	2 X 68-Pos .050 Series D-Type Shielded, Type SH68-68-S, 1 m	2 X 68-Pos .050 Series D-Type Shielded, Type SH68-68-S, 2 m	2 X 68-Pos .050 Series D-Type Shielded, Type SH68-68-S, 5 m	2 X 68-Pos .050 Series D-Type Shielded, Type SH68-68-S, 0.5 m	TB Extension-Low Voltage General 24-Ch with CJC
Part Number	777879-01	185262-01	185262-02	185262-05	786762-01	777716-01
PXI-2503	✓	✓	✓	✓	✓	✓
PXI-2530B	—	—	—	—	—	—
PXI-2532B	—	—	—	—	—	—
PXIe-2529	—	—	—	—	—	—
PXIe-2737	—	—	—	—	—	—
PXIe-2530B	—	—	—	—	—	—
PXIe-2532B	—	—	—	—	—	—

## Matrix Switch Accessories (continued)

Description	TBX-68 Connector Block	50 Pin D-SUB Screw Terminal Block	Screw Terminal Block Accessory for TB-264XB (60 VDC)	Matrix Expansion Cable for TB-264XB Terminal Blocks (60 VDC, 9 in.)	Row and Column Cable Kit for TB-264XB Terminal Blocks (60 VDC, 1.5 m)	Row and Column Cable Kit for TB-264XB Terminal Blocks (100 VDC, 1.5 m)
Part Number	777141-01	782866-01	779341-01	779325-01	779346-01	782427-01
PXI-2503	✓	—	—	—	—	—
PXI-2530B	—	—	—	—	—	—
PXI-2532B	—	—	—	—	—	—
PXIe-2529	—	—	—	—	—	—
PXIe-2737	—	✓	—	—	—	—
PXIe-2530B	—	—	—	—	—	—
PXIe-2532B	—	—	✓	✓	✓	✓

## Matrix Switch Accessories (continued)

Description	Terminal Block for NI2531 as 4 X 128 Matrix	NI TB-2649 Terminal Block for NI 2531 as Dual 4 X 64 Matrix	NI TB-2640B Terminal Block for NI 2532B as 4 X 128 Matrix	NI TB-2640B Terminal Block for NI 2532B as 4 X 128 Matrix W/100 Ω	NI TB-2641B Terminal Block for NI 2532B as 8 X 64 Matrix	NI TB-2641B Terminal Block for NI 2532B as 8 X 64 Matrix w/100 Ω
Part Number	781131-01	781131-02	782385-01	782385-02	782385-03	782385-04
PXI-2503	—	—	—	—	—	—
PXI-2530B	—	—	—	—	—	—
PXI-2532B	—	—	—	—	—	—
PXIe-2529	—	—	—	—	—	—
PXIe-2737	—	—	—	—	—	—
PXIe-2530B	—	—	—	—	—	—
PXIe-2532B	✓	✓	✓	✓	✓	✓

## Matrix Switch Accessories (continued)

Description	NI TB-2642B Terminal Block for NI 2532B as 16 X 32 Matrix	NI TB-2642B Terminal Block for NI 2532B as 16 X 32 Matrix w/100 Ω	NI TB-2643B Terminal Block for NI 2532B as 4 X 64 Matrix	NI TB-2643B Terminal Block for NI 2532B as 4 X 64 Matrix W/100 Ω	NI TB-2644B Terminal Block for NI 2532B as 8 X 32 Matrix	NI TB-2644B Terminal Block for NI 2532B as 8 X 32 Matrix W/100 Ω
Part Number	782385-05	782385-06	782385-07	782385-08	782385-09	782385-10
PXI-2503	—	—	—	—	—	—
PXI-2530B	—	—	—	—	—	—
PXI-2532B	—	—	—	—	—	—
PXIe-2529	—	—	—	—	—	—
PXIe-2737	—	—	—	—	—	—
PXIe-2530B	—	—	—	—	—	—
PXIe-2532B	✓	✓	✓	✓	✓	✓

## Matrix Switch Accessories (continued)

Description	NI TB-2645B Terminal Block for NI 2532B as 16 X 16 Matrix	NI TB-2645B Terminal Block for NI 2532B as 16 X 16 Matrix W/100 Ω	NI TB-2646B Terminal Block for NI 2532B as 4 X 32 Matrix	NI TB-2646B Terminal Block for NI 2532B as 4 X 32 Matrix W/100 Ω	Matrix Expansion Cable for TB-264XB Terminal Blocks (100 VDC, 9 In.)
Part Number	782385-11	782385-12	782385-13	782385-14	782426-01
PXI-2503	—	—	—	—	—
PXI-2530B	—	—	—	—	—
PXI-2532B	—	—	—	—	—
PXIe-2529	—	—	—	—	—
PXIe-2737	—	—	—	—	—
PXIe-2530B	—	—	—	—	—
PXIe-2532B	✓	✓	✓	✓	✓



## Multiplexer Switches

### Multiplexer Switch Accessories (continued)

Description	NI TBX-50, 50 Pin D-SUB Screw Terminal Block	NI TB-2676 Terminal Block for NI PXI-2576	Ribbon Cable Kit for NI TB-2676 Terminal Block	LFH160 to 50-Pin D-SUB	160 Pin DIN to Bare Wire Cable for PXI Switches, 1 m	160 Pin DIN to 160 Pin DIN Cable for PXI Switches, 1 m	160 Pin DIN to 4 D-SUB Cable for PXI Switches, 1 m
Part Number	779305-01	779535-01	779669-01	780009-01	782417-01	782417-02	782417-03
PXI-2575	✓	—	—	✓	—	—	—
PXI-2576	✓	✓	✓	✓	—	—	—
PXIe-2525	✓	—	—	—	✓	✓	✓
PXIe-2527	—	—	—	—	—	—	—
PXIe-2575	✓	—	—	✓	—	—	—

### Multiplexer Switch Accessories (continued)

Description	NI TBX-50B, 50 Pin D-SUB Screw Terminal Block	Cable for PXI-2520 (160-Pin DIN to 160-Pin DIN)	160-Pin DIN to Bare Wire	Relay Replacement Kit for IM42GR Relays (Qty: 10)	SH37F-37M-1 37-Pin Female to Male Shielded I/O Cable, 1 m	SH37F-37M-2 37-Pin Female to Male Shielded I/O Cable, 2 m	MCX Plug to MCX Plug, 0.15 m
Part Number	782866-01	781090-02	781090-03	779356-01	778621-01	778621-02	188374-0R15
PXI-2575	✓	—	—	—	—	—	—
PXI-2576	✓	—	—	—	—	—	—
PXIe-2525	✓	✓	✓	—	—	—	—
PXIe-2527	—	—	—	✓	—	—	—
PXIe-2575	✓	—	—	—	—	—	—

### Multiplexer Switch Accessories (continued)

Description	LFH200 Connector to Bare Wire Switch Cable, 60 VDC, 2 m	LFH200 to 4X50-Pin D-SUB Switch Cable (Ch-Com Twisted), 60 VDC, 1 m	LFH200 to 4X50-Pin D-SUB Switch Cable (Ch-Ch Twisted), 60 VDC, 1 m	LFH200 to 4X50-Pin D-SUB Switch Cable (Ch-Com Twisted), 60 VDC, 2 m	Terminal Block for NI PXI-2527
Part Number	779038-01	779038-02	779038-03	783139-02	779358-01
PXI-2575	✓	✓	✓	✓	—
PXI-2576	—	—	—	—	—
PXIe-2525	—	—	—	—	—
PXIe-2527	—	—	—	—	✓
PXIe-2575	✓	✓	✓	✓	—

## RF Switches

### RF Switch Accessories

Description	MCX Plug to MCX Plug, 0.15 m	MCX Plug to BNC Plug, 1 m	MCX Plug to BNC Plug, 0.3 m	MCX Male to SMB Female Cable, 50 Ω, 30 cm	MCX Male to SMB Female Cable, 50 Ω, 1 m	MCX Male to SMA Male Cable, 50 Ω, 1 m	MCX Male to MCX Male Cable, 50 Ω, 1 m	MCX Male to MCX Male Cable, 50 Ω, 30 cm
Part Number	188374-OR15	188375-01	188375-OR3	188376-OR3	188376-01	188377-01	188374-01	188374-OR3
PXI-2546	—	—	—	—	—	✓	—	—
PXI-2548	—	—	—	—	—	✓	—	—
PXIe-2543	—	—	—	—	—	✓	—	—
PXIe-2544	—	—	—	—	—	✓	—	—
PXIe-2746	✓	✓	✓	✓	✓	✓	✓	✓

### RF Switch Accessories (continued)

Description	MCX Male to SMA Male Cable, 50 Ω, 30 cm	MCX Male to BNC Male Cable, 50 Ω, 1 m	MCX Male to BNC Male Cable, 50 Ω, 30 cm	MCX Male to MCX Male Cable, 50 Ω, 15 cm	SMA Male to SMA Male Cable, 50 Ω, 38.1 cm	SMA Male to SMA Male Cable, 50 Ω, 12.7 cm	SMA Male to SMA Male Cable for USRP, 50 Ω, 2 m	SMA Male to SMA Male Cable, 50 Ω, 30 cm
Part Number	188377-OR3	188375-01	188375-OR3	188374-OR15	763444-01	763443-01	783470-01	781846-01
PXI-2546	—	—	—	—	✓	✓	✓	✓
PXI-2548	—	—	—	—	✓	✓	✓	✓
PXIe-2543	✓	—	—	—	—	—	—	—
PXIe-2544	✓	—	—	—	—	—	—	—
PXIe-2746	✓	✓	✓	✓	—	—	—	—

## SwitchBlock

### SwitchBlock Accessories

Description	SH96F-96M Cable for NI SwitchBlock, 1 m	SH96F-96M Cable for NI SwitchBlock, 0.5 m	SH96F-96M Cable for NI SwitchBlock, 1.5 m	SH96F-96M-Res Cable for NI SwitchBlock (100 Ω Protection), 1 m	SH96F-96M-42V Shielded Cable for PXIe-4304/5 to Rack-Mount Terminal Block, 1 m
Part Number	150275-01	150275-OR5	150275-1R5	150579-01	158228-01
SWB-2810	✓	✓	✓	✓	✓
SWB-2816	✓	✓	✓	✓	✓
SWB-2834	✓	✓	✓	✓	✓

### SwitchBlock Accessories



Description	SH96F-96M-42V Shielded Cable for PXIe-4304/5 to Rack-Mount Terminal Block, 3 m	SH96F-96M-42V Shielded Cable for PXIe-4304/5 to Rack-Mount Terminal Block, 5 m	SH96F-96M-Cal4330, Shielded Cable for PXIe-4330 and PXIe-4331 to CAL-4330, 1 m	96-Pin Screw Terminal Accessory for NI SwitchBlock
Part Number	158228-03	158228-05	787003-01	781420-09
SWB-2810	✓	✓	✓	✓
SWB-2816	✓	✓	✓	✓
SWB-2834	✓	✓	✓	✓



Recommended software (sold separately):

-  LabVIEW
-  InstrumentStudio Professional

Additional resources for software development:

- C/C++, C#, Python
-  InstrumentStudio
-  LabWindows/CVI

## PXI Source Measure Units

- Up to 24 channels (408 per chassis)
- Up to 200 V and 3 A (10 A pulse)
- Current sensitivity down to 10 fA
- Max power per channel of 40 W (500 W pulse)

### Key Features:

#### Unmatched Channel Density

Reduce test time, increase throughput, and meet today's manufacturing requirements by reducing a full rack to a few inches of physical space with up to 408 SMU channels in a single PXI chassis.

#### Built-In IV Sweep

Reconfigure and repurpose the same SMUs across test cases with configuration-based IV sweeps in InstrumentStudio software and a path to more advanced customization in programming environments.

#### High-Power Pulsing

Operate beyond the basic DC power boundary of PXI SMUs by pulsing current or voltage instead of supplying a constant DC source, allowing you to test at high instantaneous power with limited or no heat sink infrastructure.

## PXI Source Measure Unit Modules

Selection Guide	Model	Part Number	Channel Count	Max Voltage	Max Current	Current Sensitivity	Max Source Power	Max Sink Power	Pulsing	Max Sample Rate	SourceAdapt
1-Channel Precision SMU, 20 W	<a href="#">PXIe-4135</a>	783762-01	1	200 V	1 A	10 fA	20 W	20 W	✓	1.8 MS/s	✓
1-Channel Precision SMU, 40 W	<a href="#">PXIe-4135</a>	783762-02	1	200 V	1 A	10 fA	40 W	40 W	✓	1.8 MS/s	✓
1-Channel Lower-Cost SMU, 20 W	<a href="#">PXIe-4136</a>	783760-01	1	200 V	1 A	1 pA	20 W	20 W	—	1.8 MS/s	—
1-Channel Precision SMU, 20 W	<a href="#">PXIe-4137</a>	783761-01	1	200 V	1 A	100 fA	20 W	20 W	✓	1.8 MS/s	✓
1-Channel Precision SMU, 40 W	<a href="#">PXIe-4137</a>	783761-02	1	200 V	1 A	100 fA	40 W	40 W	✓	1.8 MS/s	✓
1-Channel Lower-Cost SMU, 20 W	<a href="#">PXIe-4138</a>	782856-01	1	60 V	3 A	1 pA	20 W	20 W	—	1.8 MS/s	—
1-Channel Precision SMU, 20 W	<a href="#">PXIe-4139</a>	782856-02	1	60 V	3 A	100 fA	20 W	20 W	✓	1.8 MS/s	✓
1-Channel Precision SMU, 40 W	<a href="#">PXIe-4139</a>	782856-03	1	60 V	3 A	100 fA	40 W	40 W	✓	1.8 MS/s	✓
4-Channel Lower-Cost SMU	<a href="#">PXIe-4142</a>	782430-01	4	24 V	150 mA	100 pA	3.6 W	3.6 W	—	600 kS/s	—
4-Channel Precision SMU	<a href="#">PXIe-4143</a>	782431-01	4	24 V	150 mA	10 pA	3.6 W	3.6 W	—	600 kS/s	✓
4-Channel Lower-Cost SMU	<a href="#">PXIe-4144</a>	782432-01	4	6 V	500 mA	150 pA	3 W	3 W	—	600 kS/s	—
4-Channel Precision SMU	<a href="#">PXIe-4145</a>	782435-01	4	6 V	500 mA	15 pA	3 W	3 W	—	600 kS/s	✓
4-Channel Precision SMU	<a href="#">PXIe-4147</a>	786888-01	4	6 V	3 A	100 fA	24 W	24 W	—	1.8 MS/s	✓
12-Channel High-Density SMU	<a href="#">PXIe-4162</a>	785680-01	12	24 V	100 mA	100 pA	2.4 W	2.4 W	—	100 kS/s	✓
12-Channel High-Density Precision SMU	<a href="#">PXIe-4162</a>	785680-02	12	24 V	100 mA	10 pA	2.4 W	2.4 W	—	100 kS/s	✓
24-Channel High-Density SMU	<a href="#">PXIe-4163</a>	784483-01	24	24 V	50 mA	100 pA	1.2 W	1.2 W	—	100 kS/s	✓
24-Channel High-Density Precision SMU	<a href="#">PXIe-4163</a>	784483-02	24	24 V	50 mA	10 pA	1.2 W	1.2 W	—	100 kS/s	✓
1-Channel 500 kHz Lower-Cost LCR Meter and SMU	<a href="#">PXIe-4190</a>	788101-01	1	40 V	100 mA	1 pA	4 W	4 W	—	600 kS/s	✓
1-Channel 2 MHz LCR Meter and SMU	<a href="#">PXIe-4190</a>	788088-01	1	10 V	100 mA	1 fA	1 W	1 W	—	600 kS/s	✓

## PXI Source Measure Unit Accessories

### Cables

Cables	TriaxM-TriaxM Low-Noise Triaxial-to-Triaxial Cable			Safety Interlock Cable PXIe-4135/6/7		SH8M-7F-LL Low-Leakage Cable	
	1 m	3 m	5 m	8 in.	48 in.	1 m	2 m
Part Number	785659-01	785659-03	788746-05	142998-08	142998-48	130123-01	130123-02
PXIe-4135	✓	✓	✓	✓	✓		
PXIe-4136	—	—	—	✓	✓	✓	✓
PXIe-4137	—	—	—	✓	✓	✓	✓
PXIe-4138	—	—	—	—	—	✓	✓
PXIe-4139	—	—	—	—	—	✓	✓
PXIe-4142	—	—	—	—	—	—	—
PXIe-4143	—	—	—	—	—	—	—
PXIe-4144	—	—	—	—	—	—	—
PXIe-4145	—	—	—	—	—	—	—
PXIe-4147	—	—	—	—	—	—	—
PXIe-4162	—	—	—	—	—	—	—
PXIe-4163	—	—	—	—	—	—	—

### Cables (continued)

Cables	SHDB25F-DB25F Low-Leakage 25-Pin D-SUB Cable		SHDB62M-DB62M-LL Low-Leakage 62-Pin D-SUB Cable		SHDB62M-BW-LL Low-Leakage 62-Pin D-SUB to Bare Wire Cable	
	1 m	2 m	1 m	2 m	1 m	2 m
Part Number	132893-01	132893-02	142947-01	142947-02	142948-01	142948-02
PXIe-4135	—	—	—	—	—	—
PXIe-4136	—	—	—	—	—	—
PXIe-4137	—	—	—	—	—	—
PXIe-4138	—	—	—	—	—	—
PXIe-4139	—	—	—	—	—	—
PXIe-4142	✓	✓	—	—	—	—
PXIe-4143	✓	✓	—	—	—	—
PXIe-4144	✓	✓	—	—	—	—
PXIe-4145	✓	✓	—	—	—	—
PXIe-4147	✓	✓	—	—	—	—
PXIe-4162	—	—	✓	✓	✓	✓
PXIe-4163	—	—	✓	✓	✓	✓

## Screw Terminal Connectors and Adapters

Screw Terminal Connectors and Adapters	SA-413B Banana Jack Adapter for PXIe-4136/7/8/9	SA-413T Triaxial Adapter for PXIe-4138/9	Additional or Replacement Connector Kit*					
			Part Number	786818-01	784000-01	784484-01	784068-01	787611-01
PXIe-4135	—	—	✓	—	—	—	—	—
PXIe-4136	✓	—	—	✓	—	—	—	—
PXIe-4137	✓	—	—	✓	—	—	—	—
PXIe-4138	✓	✓	—	✓	—	—	—	—
PXIe-4139	✓	✓	—	✓	—	—	—	—
PXIe-4142	—	—	—	—	✓	—	—	—
PXIe-4143	—	—	—	—	✓	—	—	—
PXIe-4144	—	—	—	—	✓	—	—	—
PXIe-4145	—	—	—	—	✓	—	—	—
PXIe-4147	—	—	—	—	✓	—	—	—
PXIe-4162	—	—	—	—	—	✓	—	—
PXIe-4163	—	—	—	—	—	—	—	✓

\*Replacement/extra

## Protection Accessories

Protection Accessories	Open-Sense Protection Accessory without Detection		Current and Open-Sense Protection Accessory with Detection**		Open-Sense Protection Accessory with Detection		
	Part Number	787719-01	787720-01	788403-01	788404-01	787719-02	787720-02
PXIe-4162	✓	—	✓	—	✓	—	—
PXIe-4163	—	✓	—	✓	—	✓	—

\*\*Replacement/extra



Recommended software (sold separately):

 LabVIEW

 InstrumentStudio Professional

Additional resources for software development:

C/C++, C#, Python

 InstrumentStudio

 LabWindows/CVI

## PXI LCR Meter and SMU

- AC stimulus frequency up to 2 MHz
- AC stimulus amplitude up to 7.07 V<sub>rms</sub>
- DC bias up to ± 40 V
- Basic impedance accuracy of 0.05 percent

### Key Features:

#### High-Precision, High-Accuracy Measurements

NI LCR meters are built with a combination of off-the-shelf high-speed and high-precision data converter technology to provide low noise measurements across a wide range of LCR meter stimulus frequencies and SMU measurement speeds.

#### High-Speed Measurement and Update Rate

The NI PXIe-4190 provides flexible measurement time settings, including preset options (100 ms for slow, 10 ms for normal, and 1 ms for fast) and the ability to choose custom values outside of these three preset values.

#### SourceAdapt Digital Control Loop Technology

SourceAdapt is a digital control loop technology that gives you the ability to optimize the SMU response for any device under test (DUT). This provides fast and stable measurements for a variety of loads, even highly capacitive or inductive ones, and prevents damage to your DUT by removing harmful overshoots and oscillations.

### PXI LCR Meter and SMU Modules

Selection Guide	Model	Part Number	Channel Count	Min AC Stimulus Frequency	Max AC Stimulus Frequency	Max AC Stimulus Voltage	Max AC Stimulus Current	Max DC Bias Voltage (DC + AC)	Max DC Bias Current (DC + AC)
1-Channel 500 kHz Lower-Cost LCR Meter and SMU	<b>PXIe-4190</b>	788101-01	1	40 Hz	500 kHz	7.07 V <sub>rms</sub>	70.7 mA <sub>rms</sub>	10 V	100 mA
1-Channel 2 MHz LCR Meter and SMU	<b>PXIe-4190</b>	788088-01	1	40 Hz	2 MHz	7.07 V <sub>rms</sub>	70.7 mA <sub>rms</sub>	40 V	100 mA

## PXI LCR Meter and SMU Accessories

Cable	SHDB13W6-4BNM-LL Low-Leakage D-SUB to Male BNC Cable			SHDB13W6-4BNCF-LL Low-Leakage D-SUB to Female BNC Cable			SHDB13W6-4TriaxM-LL Low-Leakage D-SUB to Male Triax Cable			SHDB13W6-DB13W6-LL Low-Leakage D-SUB to D-SUB Cable		
	1 m	2 m	4 m	0.5 m	1 m	2 m	1 m	2 m	4 m	1 m	2 m	4 m
Part Number	788280- 01	788280- 02	788280- 04	789536- 0R5	789536- 01	789536- 02	788281- 01	788281- 02	788281- 04	788279- 01	788279- 02	788279- 04
PXIe-4190	✓	✓	✓	✓	✓	✓	✓	✓	✓	✓	✓	✓







Recommended software (sold separately):

-  LabVIEW<sup>®</sup>
-  Semiconductor Device Control Add-On for InstrumentStudio

Additional resources for software development:

- C/C++, C#, Python
-  Digital Pattern Editor
-  LabWindows/CVI

## PXI Digital Pattern Instruments

- 32-channel module (up to 512 per chassis)
- 100 MHz vector rate, 39 ps displacement
- Digital voltage -of 2 V to 6 V
- Up to 200 Mb/s data rate

### Key Features:

#### Dedicated Digital Pattern Editor

The Digital Pattern Editor is an interactive tool for importing, editing, or creating test patterns. The software integrates editing sheets for device pin maps, specifications, and patterns to develop or edit imported digital test vectors and patterns.

#### Debug Digital Test Patterns

The Digital Pattern Editor includes tools such as Shmoo plots to provide a deeper understanding of DUT performance across variation. The editor also offers debugging tools such as overlaying pattern failures on a pattern or using digital scope for an analog view of the pin data.

#### Programmatic Pattern Bursting

The NI-Digital Pattern Driver in LabVIEW, C, or .NET offers the ability to develop test code to interact with PXI digital pattern instruments.

### PXI Digital Pattern Instrument Modules

Selection Guide	Model	Part Number	Active Load	Channels	Maximum Vector Rate	Maximum Data Rate	Maximum Clock Generation	Pattern Timing	Drive Formats	Timing Specifications
Higher Channel Count, Higher Active Load	<a href="#">PXIE-6570</a>	785283-01	24 mA	32 per Module	100 MHz (10 ns Minimum Vector Period)	200 Mb/s	160 MHz*	31 Time Sets 39.0625 ps Edge-Placement Resolution	Nonreturn (NR), Return to Low (RL), Return to High (RH) (100 MHz max), Surround by Complement (SBC) (50 MHz max)	Warranted
Higher Channel Count	<a href="#">PXIE-6571</a>	786320-01	16 mA	32 per Module						Warranted
General Purpose	<a href="#">PXIE-6571</a>	786320-02	16 mA	8 per Module						Typical

\*Clock rates >133 MHz will have a non-50% duty cycle.

\*\* See the [PXI Digital Waveform and Pattern Instrument Accessories](#)

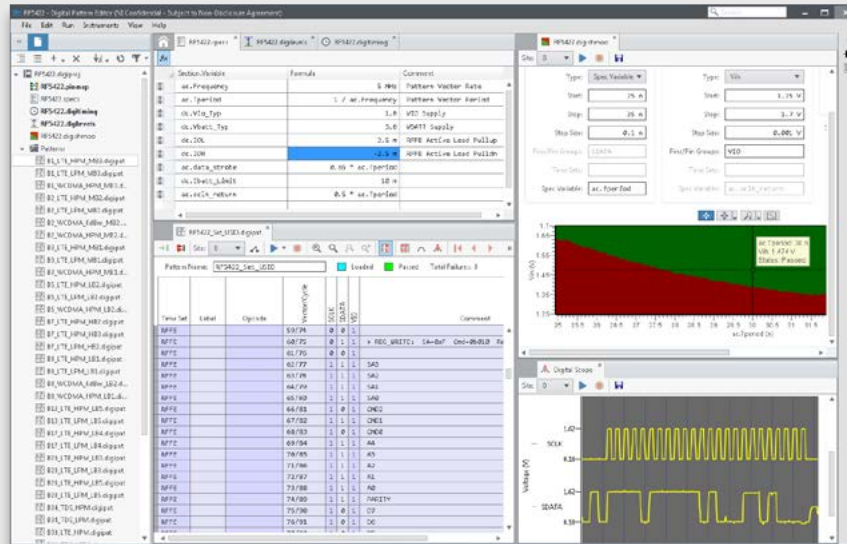

## NI Digital Pattern Editor Application Software

The Digital Pattern Editor is an interactive tool for importing, editing, or creating test patterns. All the sheets developed in the Digital Pattern Editor can be reused by the API in LabVIEW, C, or .NET languages, as well as in the TestStand Semiconductor Module.

### Pattern Development and Format

A pattern file is a collection of vectors, with each vector containing time sets, labels, opcodes, pin states, and comments. The Digital Pattern Editor has development sheets for all these items as well as debug tools for refining patterns, time sets, and specifications. A compiled, binary version of the pattern file is required to edit or burst. Engineers can compile an ASCII text pattern file format (.digpatsrc) into a binary version using the Digital Pattern Editor or a command line process. The ASCII form can be used to convert existing patterns by following the well-defined pattern file format. Design simulation and SCAN files generated by EDA tools can be cyclized and targeted to the NI format using existing customer in-house EDA workflows or third-party cyclizing tools.

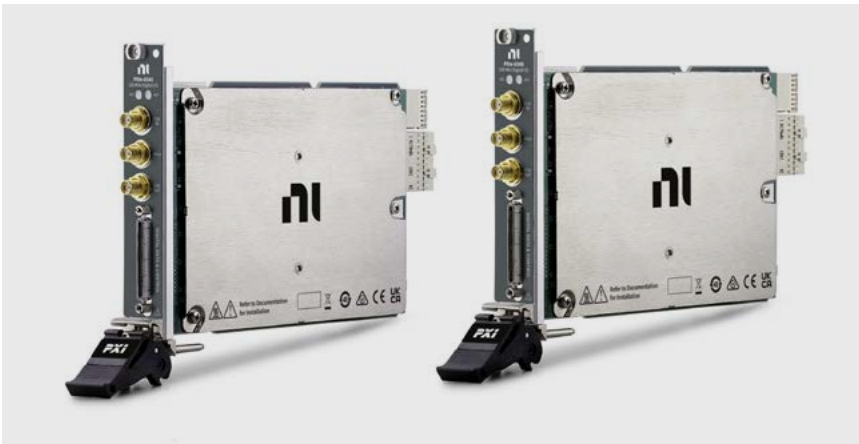

Recommended software (sold separately):

 LabVIEW

 Digital Waveform Editor

Additional resources for software development:

C/C++, C#, Python

 LabWindows/CVI

## PXI Digital Waveform Instruments

- Standard TTL/CMOS interface voltages and programmable voltage levels
- 32 bidirectional digital channels
- Advanced waveform sequencing and streaming features
- Up to 200 Mb/s SDR and 400 Mb/s DDR

### Key Features:

#### Synchronization and Memory Core (SMC)

The synchronization and memory core architecture is designed to enhance testing efficiency through deep onboard memory, flexible data transfer cores, and precise timing synchronization.

#### Dedicated Digital Waveform Editor

The Digital Waveform Editor is a software tool that facilitates creating, editing, and importing digital waveforms for customized interfacing and test conditions. The editor also supports the design of digital vectors with six drive and compare states.

#### Driver and API Support

The NI-HSDIO driver includes a flexible API based on IVI guidelines, complete documentation of supported hardware, and configuration and testing utilities to communicate with PXI digital waveform instruments.

## PXI Digital Waveform Instrument Modules

Selection Guide	Model	Part Number	Number of Bidirectional Digital Channels	Logic Family	Maximum Sample Clock	Maximum Generation Rate	Maximum Acquisition Rate	Onboard Memory	Hardware Compare
Starter Module	PXIe-6544	780992-01	32	1.2 V, 1.5 V, 1.8 V, 2.5 V, 3.3 V	100 MHz	100 Mb/s SDR	100 Mb/s SDR	1 Mb/ch (4 MB total)	—
		780992-02	32	1.2 V, 1.5 V, 1.8xV, 2.5 V, 3.3 V	100 MHz	100 Mb/s SDR	100 Mb/s SDR	8 Mb/ch (32 MB total)	—
		780992-03	32	1.2 V, 1.5 V, 1.8=V, 2.5 V, 3.3 V	100 MHz	100 Mb/s SDR	100 Mb/s SDR	64 Mb/ch (256 MB total)	—
Higher Clock Rate	PXIe-6545	780993-01	32	1.2 V, 1.5 V, 1.8 V, 2.5 V, 3.3 V	200 MHz	200 Mb/s SDR	200 Mb/s SDR	1 Mb/ch (4 MB total)	—
		780993-02	32	1.2 V, 1.5 V, 1.8 V, 2.5 V, 3.3 V	200 MHz	200 Mb/s SDR	200 Mb/s SDR	8 Mb/ch (32 MB total)	—
		780993-03	32	1.2 V, 1.5 V, 1.8 V, 2.5 V, 3.3 V	200 MHz	200 Mb/s SDR	200 Mb/s SDR	64 Mb/ch (256 MB total)	—
Programmable Voltage Levels	PXIe-6547	781011-01	32	1.2 V–3.3 V Programmable	100 MHz	100 Mb/s SDR (200 Mb/s DDR)	100 Mb/s SDR (200 Mb/s DDR)	1 Mb/ch (4 MB total)	✓
		781011-02	32	1.2 V–3.3 V Programmable	100 MHz	100 Mb/s SDR (200 Mb/s DDR)	100 Mb/s SDR (200 Mb/s DDR)	8 Mb/ch (32 MB total)	✓
		781011-03	32	1.2 V–3.3 V Programmable	100 MHz	100 Mb/s SDR (200 Mb/s DDR)	100 Mb/s SDR (200 Mb/s DDR)	64 Mb/ch (256 MB total)	✓
Higher Clock Rate + Programmable Voltage Levels	PXIe-6548	781012-01	32	1.2 V–3.3 V Programmable	200 MHz	200 Mb/s SDR (400 Mb/s DDR)*	200 Mb/s SDR (300 Mb/s DDR)*	1 Mb/ch (4 MB total)	✓
		781012-02	32	1.2 V–3.3 V Programmable	200 MHz	200 Mb/s SDR (400 Mb/s DDR)*	200 Mb/s SDR (300 Mb/s DDR)*	8 Mb/ch (32 MB total)	✓
		781012-03	32	1.2 V–3.3 V Programmable	200 MHz	200 Mb/s SDR (400 Mb/s DDR)*	200 Mb/s SDR (300 Mb/s DDR)*	64 Mb/ch (256 MB total)	✓

\*Maximum DDR data rate is dependent on logic family or programmed voltage level. See specs for mapping of voltage levels to data rates.

## PXI Digital Waveform and Pattern Instrument Accessories

### Digital Cables

Digital Cables	SHC68-C68-D4 Shielded Single-Ended Cable, 0.55 m	SHC68-C68-D4 Shielded Single-Ended Cable, 1 m	SHC68-C68-D4 Shielded Single-Ended Cable, 2 m	SHC68-C68-D4 Shielded Single-Ended Cable, Low Leakage, 1 m	SHC68-C68-D4 Shielded Single-Ended Cable, Lower DC Resistance, 3 m	C68-C68-D4 Unshielded Cable, 2X68-Position VHDCI Offset, 1 m	SHC68-H1X38 High-Speed Digital Flying-Leads Cable Accessory, 1.5 m
Part Number	781013-01	196275-01	781293-01	152870-01	132625-03	195949-01	192681-1R5
Shielding	Shielded	Shielded	Shielded	Shielded	Shielded	Unshielded	Shielded
PXIe-6570	✓	✓	✓	✓	✓	✓	✓
PXIe-6571	✓	✓	✓	✓	✓	✓	✓
PXIe-6544	✓	✓	✓	✓	✓	✓	✓
PXIe-6545	✓	✓	✓	✓	✓	✓	✓
PXIe-6547	✓	✓	✓	✓	✓	✓	✓
PXIe-6548	✓	✓	✓	✓	✓	✓	✓

### Breakout Terminal Blocks, Boxes, and Adapters



Breakout Terminal Blocks, Boxes, and Adapters	SCB-68 HSDIO, Shielded 68-Pin Connector Block for R Series DIO and HSDIO Products	CB-2162 Single-Ended Digital I/O Accessory	SMB-2163 Single-Ended Digital I/O Accessory (Rack-Mountable)	653x Cable Adapter, 68-Pin D-Type to 68-Pin VHDCI Adapter	SCB-68A Noise-Rejecting, Shielded I/O Connector Block	CB-68LP Low-Cost, Unshielded I/O Connector Block	CB-68LPR I/O Connector Block	TBX-68, 68-Pin Screw Terminal Connector Block
Part Number	782914-01	778592-01	778747-01	195846-01	782536-01	777145-01	777145-02	777141-01
Receptacle	68-Pin 0.8 mm VHDCI	68-Pin 0.8 mm VHDCI	68-Pin 0.8 mm VHDCI	68-Pin SCSI 0.050 D-Type Female	68-Pin SCSI 0.050 D-Type Male	68-Pin SCSI 0.050 D-Type Male	68-Pin SCSI 0.050 D-Type Male	68-Pin SCSI 0.050 D-Type Female
Output Connections	Screw Terminal	Through-Hold and Surface-Mount Solder Pads	SMB	68-Pin 0.8 mm VHDCI	Screw Terminal	Screw Terminal	Screw Terminal	Screw Terminal
Shielding	Shielded	Unshielded	Shielded	N/A	Shielded	Unshielded	Unshielded	Unshielded
PXIe-6570	✓	✓	✓	—	—	—	—	—
PXIe-6571	✓	✓	✓	—	—	—	—	—
PXIe-6544	✓	✓	✓	✓	✓	✓	✓	✓
PXIe-6545	✓	✓	✓	✓	✓	✓	✓	✓
PXIe-6547	✓	✓	✓	✓	✓	✓	✓	✓
PXIe-6548	✓	✓	✓	✓	✓	✓	✓	✓



Recommended software (sold separately):

-  LabVIEW
-  InstrumentStudio Professional

Additional resources for software development:

- C/C++, C#, Python
-  InstrumentStudio
-  LabWindows/CVI

## PXI Electronic Loads

- Ability to sink up to 300 W of DC power
- Voltage and current measurements with sample rates up to 1.8 MS/s and update rates up to 100 kS/s
- Hardware timing and triggering
- 4-wire remote sense

### Key Features:

#### Acquire Data at High Speed

You can sink up to 300 W of power into the PXI electronic load module to test a range of electronic devices, all while gathering voltage and current measurements at rates up to 1.8 MS/s. The first PXI electronic load module in the industry also features high-speed data converters that offer update rates up to 100 kS/s.

#### Improve Accuracy with Selectable Ranges

When measuring voltage or current with the PXI electronic load module, you have multiple measurement ranges to choose from. You can enhance the accuracy of your measurement by selecting the most suitable range for the magnitude of the measurement, optimizing the ADC range.

#### Tune the Transient Response

You can maximize stability, reduce overshoot, and decrease test times by digitally controlling the transient response of the PXI electronic load module. NI SourceAdapt, a patented technology on the PXI electronic load module, power supplies, and source measure units (SMUs), eliminates custom circuitry.

## PXI Electronic Load Modules

Selection Guide	Model	Part Number	PXI Slots	Maximum Voltage (V)	Maximum Current (A)	Maximum Power Per Channel (W)	Maximum Voltage Measurement Resolution	Maximum Current Measurement Resolution	SourceAdapt
1-Channel, 60 V, 40 A PXI Electronic Load Module	PXIe-4051	788179-01	3	60	40*	300	1 $\mu$ V	10 $\mu$ A	✓

\*Requires an 82 W PXI chassis to achieve maximum power of 300 W

## PXI Electronic Load Accessories

### Connectors and Connector Kits

Connectors and Connector Kits	Connector Kit for PXIe-4150/1 Power Supplies and PXIe-4051 Electronic Load
Part Number	788197-01
PXIe-4051	✓



Recommended software (sold separately):

- ▶ LabVIEW
- ▶ LabVIEW Real-Time Module
- ▶ LabVIEW FPGA

Additional resources for software development:

- C/C++, Python,
- ▶ LabWindows/CVI

## PXI High-Speed Serial

Up to 48 Xilinx multigigabit transceivers (MGTs) with line rates up to 28.2 Gb/s

Various high-speed serial protocols on the user-programmable Xilinx Kintex UltraScale + or 7 series FPGAs

High-speed P2P backplane data streaming up to 7 GB/s to host, disk, or other PXI Express modules

Up to 20 GB onboard DDR3 DRAM

### Key Features:

#### Protocol Flexibility

PXI high-speed serial instruments leverage Xilinx FPGAs and flexible clocking circuitry to implement a variety of both standard and custom high-speed serial protocols.

#### Data Streaming

High-speed serial instruments benefit from PXI high-speed data movement capabilities. The modules have a PCI Express Gen 3 x8 interface for sustained data streaming rates of 7 GB/s unidirectional and 2.4 GB/s bidirectional to or from a host processor or other instruments that support P2P streaming.

#### Flexible Software Experience

PXI high-speed serial instruments support programming with either NI LabVIEW FPGA or VHDL via Xilinx Vivado.



## PXI High-Speed Serial Modules

Selection Guide	Model	Part Number	HSS Physical Ports	Multi-Gigabit Transceivers (MGTS)	Max Line Rate (Gb/s)	Max Throughput (GB/s)	FPGA Family	High-Speed Serial Connector	PXI Express Slots
Lowest Cost	<b>PXIE-6592</b>	783639-01	4	4	10	5	Kintex-7 K410	SFP+	1
Low Cost	<b>PXIE-6591</b>	783638-01	2	8	12.5	13	Kintex-7 K410	MiniSAS-HD	1
	<b>PXIE-6593</b>	785976-01	2	8	16.3	16	Ultrascale KU040	QSFP28	1
	<b>PXIE-6593</b>	785977-01	2	8	16.3	16	UltraScale KU060	QSFP28	1
High Throughput, Large FPGA	<b>PXIE-6594</b>	786939-01	2	8	28.2	28	UltraScale+ KU15R	QSFP28	1
High Throughput	<b>PXIE-7902</b>	784232-01	6	24	12.5	38	Virtex-7	MiniSAS-HD	1
Highest Throughput, Largest FPGA	<b>PXIE-7903</b>	788917-01	12	48	28.2	169	UltraScale+ VU11P	MiniSAS-zHD	2

## PXI High-Speed Serial Accessories

### Cables

Cable	MINI-SAS HD Cable x4 Lanes, 1 m	MINI-SAS HD Cable x4 Lanes, 3 m	MINI-SAS HD Optical Cable x4 Lanes, 10 m	SMA-SMA Cable, 1 m	SMB-SMB Cable, 1 m	QSFP28-QSFP28 Cable, 1 m	QSFP28-QSFP28 Cable, 2 m	QSFP28-QSFP28 Active Optical Cable, 10 m
Part Number	783976-01	783977-01	783978-01	783469-01	188859-01	788256-01	788256-02	788257-10
PXIE-6591	✓	✓	—	✓	—	—	—	—
PXIE-6592	—	—	—	—	✓	—	—	—
PXIE-6593	—	—	—	✓	—	✓	✓	✓
PXIE-6594	—	—	—	✓	—	✓	✓	✓
PXIE-7902	✓	✓	✓	✓	—	—	—	—
PXIE-7903	—	—	—	✓	—	—	—	—

### Cables (continued)



Cable	zHD to QSFP28 Cable, 2 m	zHD to zHD Cable, 1 m	zHD to zHD Cable, 2 m	zHD to zHD Cable, 0.5 m	SHC68-C68-D4 Single-Ended Cable, 1 m	SFP+ Copper Cable, 1 m	Nano-Pitch-Nano-Pitch Cable, 1 m	mHDMI to mHDMI, 1 m
Part Number	788928-02	788927-01	788927-02	788927-0R5	152870-01	784076-01	785486-01	784091-01
PXIE-6591	—	—	—	—	✓	—	—	—
PXIE-6592	—	—	—	—	—	✓	—	—
PXIE-6593	—	—	—	—	—	—	✓	—
PXIE-6594	—	—	—	—	—	—	✓	—
PXIE-7902	—	—	—	—	—	—	—	—
PXIE-7903	✓	✓	✓	✓	—	—	—	✓

## Connector Blocks

Connector Block	CB-2162 Digital Connector Block	SCB-12 Nano-Pitch Connector Block	SCB-19 mHDMI Connector Block
Part Number	778592-01	787419-01	783959-01
PXIe-6591	✓	—	—
PXIe-6592	—	—	—
PXIe-6593	—	✓	—
PXIe-6594	—	✓	—
PXIe-7902	—	—	—
PXIe-7903	—	—	✓



Recommended software (sold separately):

-  LabVIEW
-  LabVIEW Real-Time Module

Additional resources for software development:

- C/C++
-  LabWindows/CVI

## PXI Timing and Synchronization

Generate high-stability PXI system reference clocks and high-resolution sample clocks

Achieve synchronization over long distance through GPS, IEEE 1588, IRIG-B, or PPS

Develop advanced timing and sync applications with NI-Sync and NI-TClk software

Import and export system reference clocks for synchronization between multiple chassis or external devices

### Key Features:

#### High-Stability, High-Accuracy Onboard Clock

Replace this backplane system reference clock using a higher accuracy oscillator for high-performance applications.

#### Time-Base Synchronization

Generate triggers and clock signals at programmable future times, and timestamp input events with the synchronized system time.

#### Advanced Clock and Trigger Routing

Timing and synchronization modules provide many more source-to-destination routes for more flexible designs and efficient use of system resources.

### PXI Timing and Synchronization Modules

Selection Guide	Model	Part Number	Connector Types	Supported Timing Protocols	Onboard Oscillator Accuracy	DDS Range	Override PXI 10 MHz Backplane Clock	PXI Star-Capable	PXI Express DSTAR-Capable
Ethernet and GPS Time Sync	<b>PXI-6683H</b>	782110-01 782110-02	RJ-45, SMB	IEEE-1588, GPS, IRIG-B, IEEE-802.1as (Linux only), PPS	+/-3.5 ppm	—	—	—	—
Clock and Trigger Routing and Generation	<b>PXIe-6672</b>	783639-01	SMB	—	+/-3.5 ppm	DC to 105 MHz	✓	✓	—
High-Performance Clock and Trigger Routing and Generation	<b>PXIe-6674T</b>	785976-01	SMA	—	+/-80 ppb	0.3 Hz to 1 GHz	✓	✓	✓

## PXI Timing and Synchronization Accessories

### Cables and Terminal Blocks

Description	Ethernet Cable, 2 m	Ethernet Cable, 5 m	GPS Antenna, Bullet III	SMB-SMB Cable, 1 m	SMB-Alligator Cable	SMB-Alligator Cable	SMA-SMA Cable, 1 m
Part Number	151733-02	151733-05	196304-30	188859-01	763388-01	763388-01	783469-01
PXI-6683H	✓	✓	✓	✓	✓	—	—
PXIe-6672	—	—	—	✓	—	✓	—
PXIe-6674T	—	—	—	—	—	—	✓



Recommended software (sold separately):

▶ LabVIEW

+ LabVIEW Sound and Vibration Toolkit

Additional resources for software development:

C/C++, C#, Python,

▣ LabWindows/CVI

## PXI Sound and Vibration Modules

- Dynamic sensor measurements at 51.2 kS/s, 102.4 kS/s, 204.8 kS/s, or 1.25 MS/s
- Built-in highpass filtering
- Reliable dynamic signal characterization
- Per-channel, software-selectable AC input coupling
- Per-channel, software-selectable input gain settings

### Key Features:

#### Perform Signal-Chain Distortion Analysis

The PXIe-4468 sound and vibration module supports benchtop-quality signal-chain distortion analysis in a single-slot PXI Express form factor. Additional new features include Pure Tone sine wave generation mode for more test coverage as well as support for independent operation and synchronization of each channel for improved utilization in test systems.

#### Generate and Acquire High-Dynamic-Range Signals

NI's PXI Sound and Vibration Module is a dynamic signal acquisition (DSA) device that can accurately measure the frequency content of signals with a very high dynamic range. Modules provide software-configurable AC/DC coupling, antialiasing filters, and IEPE conditioning to ensure precision measurements with microphones, accelerometers, and other transducers with large dynamic ranges.

#### Add Accelerometer Measurements to Your System

PXI Sound and Vibration Modules and the accompanying NI software make it fast to connect microphones and accelerometers for vibration test and measurement. NI-DAQmx supports NI programming environments as well as Python, ANSI C, C#.NET, and MathWorks® MATLAB® software.

## PXI Sound and Vibration Modules

Selection Guide	Model	Part Number	DSA Dynamic Range	Front Connection Type	Highpass Filter Cutoff Frequency	Max Differential Analog	Max Sample Rate	Analog Output Channels	Gain Settings
AO Only	PXIe-4463	783086-01	—	BNC BNC SMB SMB	3.4 Hz	—	51.2 kS/s	2	3
		783086-02	—	Mini-XLR Mini-XLR SMB SMB	3.4 Hz	—	51.2 kS/s	2	3
AI Only	PXIe-4464	783087-01	119 dB	BNC BNC BNC BNC SMB	0.72 Hz	4	204.8 kS/s	—	6
		783087-02	119 dB	Mini-XLR Mini-XLR Mini-XLR Mini-XLR SMB	0.72 Hz	4	204.8 kS/s	—	6
2 AI, 2 AO	PXIe-4468	788511-01	121 dB	BNC BNC BNC BNC SMB	0.8 Hz	2	250 kS/s	2	6
		788512-01	121 dB	Mini-XLR Mini-XLR Mini-XLR Mini-XLR SMB	0.8 Hz	2	250 kS/s	2	6
High Bandwidth with Signal Conditioning	PXIe-4480*	784277-01	115 dB	InfiniBand (IB) SMB	0.5 Hz	6	1.25 MS/s	—	4
High Bandwidth	PXIe-4481	784278-01	115 dB	InfiniBand (IB) SMB	0.5 Hz	6	1.25 MS/s	—	4

\*Antialiasing Filter, Voltage Excitation, Current Excitation Signal Conditioning

## PXI Sound and Vibration Modules Accessories

### Cables

Cables	BNC Male to BNC Male Cable, 75 Ω, 2 m (x4)	Extended Temperature, BNCM-MXLRF, 0.46 m	Extended Temperature, BNCM-MXLRF 0.91 m	Extended Temperature, BNCM-MXLRF 2.4 m	Extended Temperature, MXLRF-MXLRF 0.46 m
Part Number	779697-02	140150-0R46	140150-0R91	140150-2R4	140151-0R46
PXIe-4463, MXLR [783086-02]	—	✓	✓	✓	✓
PXIe-4463, BNC [783086-01]	✓	—	—	—	—
PXIe-4464, MXLR [783097-02]	—	✓	✓	✓	✓
PXIe-4464, BNC [783097-01]	✓	—	—	—	—
PXIe-4468, MXLR [788512-01]	—	✓	✓	✓	✓
PXIe-4468, BNC [788511-01]	✓	—	—	—	—
PXIe-4480, InfiniBand [784277-01]	—	—	—	—	—
PXIe-4481, Infiniband [784278-01]	—	—	—	—	—

## Cables (continued)

Cables	Extended Temperature, MXLRF-MXLRF 0.91 m	Extended Temperature, MXLRF-MXLRF 2.4 m	Extended Temperature, MXLRF-XLRM, 0.46M, 3-Pin Female Mini-XLR	SMB-100, SMB Female to BNC Female Coax Cable, 50 Ω, 0.08 m	SMB-100, SMB Female to BNC Female Coax Cable, 50 Ω, 0.6 m
Part Number	140151-0R91	140151-2R4	140152-0R46	781449-01	763389-01
PXIe-4463, MXLR [783086-02]	✓	✓	✓	—	—
PXIe-4463, BNC [783086-01]	—	—	—	✓	✓
PXIe-4464, MXLR [783097-02]	✓	✓	✓	—	—
PXIe-4464, BNC [783097-01]	—	—	—	✓	✓
PXIe-4468, MXLR [788512-01]	✓	✓	✓	✓	✓
PXIe-4468, BNC [788511-01]	—	—	—	✓	✓
PXIe-4480, InfiniBand [784277-01]	—	—	—	—	—
PXIe-4481, Infiniband [784278-01]	—	—	—	—	—

## Cables (continued)

Cables	SMB Female to 2 Alligator Clips Cable, 50 Ω, 1 m	SMB Female to BNC Male Coax Cable, 50 Ω, 1 m	InfiniBand SHB12x-6BNC, 0.2 m	InfiniBand SHB12x-6MXLRM, 0.2 m	InfiniBand SHB12x-6RJ50, 0.2 m
Part Number	763388-01	763405-01	140296-0R2	140303-0R2	140304-0R2
PXIe-4463, MXLR [783086-02]	—	—	—	—	—
PXIe-4463, BNC [783086-01]	✓	✓	—	—	—
PXIe-4464, MXLR [783097-02]	—	—	—	—	—
PXIe-4464, BNC [783097-01]	✓	✓	—	—	—
PXIe-4468, MXLR [788512-01]	✓	✓	—	—	—
PXIe-4468, BNC [788511-01]	✓	✓	—	—	—
PXIe-4480, InfiniBand [784277-01]	—	—	✓	✓	✓
PXIe-4481, Infiniband [784278-01]	—	—	✓	✓	✓



Recommended software (sold separately):

 LabVIEW

Additional resources for software development:

C/C++, C#, Python,

 LabWindows/CVI

## PXI Signal-Conditioning Modules

High channel density for conditioned and sensor measurements

Flexible, synchronized, and accurate measurements

Isolated measurement options

Swappable front-mount terminal block

### Key Features:

#### Accessory Auto-Detection

SC Express modules automatically detect compatible accessories or terminal blocks. The RSVD pins on the I/O connector provide power to the accessories as well as digital communication lines.

#### Multiple Timing Engines

Several SC Express modules are equipped with multiple timing engines, each customizable with its own configuration settings for timing, triggering, and sample mode (buffered or hardware-timed single point). This feature enables devices to execute multiple tasks simultaneously.

#### Chopping Mode

The PXIe-4309 supports chopping mode, which is a feature that can be used to remove offset voltages and other low frequency errors. By measuring a signal twice, once normally and once with the inputs inverted, the measurements can be averaged by the device to create each sample. This provides significant noise rejection to enable 10 nV measurements and better measurement stability over temperature.



## PXI Analog Input and Output Modules

Selection Guide	Model Name	Part Number	Analog Input Isolation	Analog Input Resolution	Analog Input Voltage Range	Discrete Lowpass Filter	Filtering	Max Differential Analog	Max Sample Rate
Isolated AI	<b>PXIe-4300</b>	781337-01	300 V Ch-Ch Isolation	16 Bits	-300 V to 300 V -150 V to 150 V -60 V to 60 V -30 V to 30 V -10 V to 10 V -5 V to 5 V -2 V to 2 V -1 V to 1 V	10 kHz 100 kHz	Butterworth	8	250 kS/s/ch
General-Purpose Filtered AI	<b>PXIe-4302</b>	783865-01	—	24 Bits	-10 V to 10 V -0.1 V to 0.1 V	2 Hz; 20 Hz; 200 Hz; 1 kHz; 2 kHz	Anti-Alias	32	5 kS/s/ch
General-Purpose Filtered AI with Higher Sampling	<b>PXIe-4303</b>	783866-01	—	24 Bits	-10 V to 10 V -0.1 V to 0.1 V	2 Hz; 20 Hz; 200 Hz; 1 kHz; 2 kHz	Anti-Alias	32	51.2 kS/s/ch
High-Voltage Filtered AI	<b>PXIe-4304</b>	783867-01	—	24 Bits	-42 V to 42 V	2 Hz; 20 Hz; 200 Hz; 1 kHz; 2 kHz	Anti-Alias	32	5 kS/s/ch
High-Voltage Filtered AI with Higher Sampling	<b>PXIe-4305</b>	783868-01	—	24 Bits	-42 V to 42 V	2 Hz 20 Hz 200 Hz 1 kHz 2 kHz	Anti-Alias	32	51.2 kS/s/ch
High-Resolution Simultaneous AI	<b>PXIe-4309</b>	784471-01	—	28 Bits	-15 V to 15 V -10 V to 10 V -1 V to 1 V -0.1 V to 0.1 V	—	Anti-Alias	32	2 MS/s/ch
Highest-Voltage Isolated AI	<b>PXIe-4310</b>	784813-01	600 V Ch-Ch Isolation	16 Bits	-600 V to 600 V -300 V to 300 V -120 V to 120 V -60 V to 60 V -10 V to 10 V -5 V to 5 V -2 V to 2 V -1 V to 1 V	10 kHz; 100 kHz	Butterworth	8	400 kS/s/ch
Isolated AO	<b>PXIe-4322</b>	782878-01	—	16 Bits	-16V to 16 V	—	—	8	250 kS/s/ch

## PXI Strain Bridge Input Modules

Selection Guide	Model Name	Part Number	Analog Input Voltage Range	Bridge Configurations	Bridge Resistance	Max Differential Analog	Max Sample Rate
Starter Module	<b>PXIe-4330</b>	781346-01	-100 mV/V to 100 mV/V -25 mV/V to 25 mV/V	Full-Bridge Quarter-Bridge Half-Bridge	120 Ω 350 Ω 1,000 Ω	8	25.6 kS/s
Fastest Sample Rates	<b>PXIe-4331</b>	781345-01	-100 mV/V to 100 mV/V -25 mV/V to 25 mV/V	Full-Bridge Half-Bridge Quarter-Bridge	120 Ω 350 Ω 1,000 Ω	8	102.4 kS/s
Largest Input Ranges	<b>PXIe-4339</b>	783531-01	-10 V to 10 V -4 V to 4 V -1 V to 1 V -0.5 V to 0.5 V -0.2 V to 0.2 V -200 mV/V to 200 mV/V -0.1 V to 0.1 V -80 mV/V to 80 mV/V -50 mV/V to 50 mV/V -40 mV/V to 40 mV/V -20 mV/V to 20 mV/V -10 mV/V to 10 mV/V	Quarter-Bridge Full-Bridge Half-Bridge	120 Ω 350 Ω 1,000 Ω	8	25.6 kS/s

## PXI Displacement Input Modules

Selection Guide	Model	Part Number	Analog Input Resolution	Input Level	Analog Inputs	Max Sample Rate	Excitation Voltage	Excitation Frequency	Max Sample Rate
Displacement Module	<b>PXIe-4340</b>	785068-01	24 Bits	+/-7 V <sub>rms</sub>	4	25.6 kS/s	1-7 V <sub>rms</sub> with 0.5 V <sub>B,rms</sub> Increments	400 Hz to 10 kHz with 10 Hz Increments	25.6 kS/s

## PXI Temperature Input Modules

Selection Guide	Model Name	Part Number	Supported Sensor Type	Analog Input Isolation	Max Number of Differential Analog
Thermocouple Module	<b>PXIe-4353</b>	781348-01	Thermocouple	300 V Bank Isolation	32
RTD Measurement Module	<b>PXIe-4357</b>	782118-01	RTD	—	20

## PXI Signal-Conditioning Accessories

### Terminal Blocks

Description	TB-4300, 10 V Input	TB-4300, 20mA Input	TB-4300B, 300 V Input	TB-4302, 10 V Input	TB-4302, 20 mA Input	TB-4304	TB-4309, Screw Terminals
Part Number	781338-01	784280-01	781338-02	783869-01	783871-01	783870-01	784956-01
PXIe-4300	✓	✓	✓	—	—	—	—
PXIe-4302	—	—	—	✓	✓	—	—
PXIe-4303	—	—	—	✓	✓	—	—
PXIe-4304	—	—	—	—	—	✓	—
PXIe-4305	—	—	—	—	—	✓	—
PXIe-4309	—	—	—	—	—	—	✓

## Terminal Blocks (continued)

Description	TB-4309, VHDCI Terminals	TB-4309, High Channel Density VHDCI Terminal	TB-4310, 10 V Input	TB-4310, 600V Input	TB-4310, 10 V Input, 10 Hz Filter	TB-4322	TB-4330
Part Number	784957-01	785743-01	785021-01	785022-01	786281-01	782882-01	781347-01
PXIe-4309	✓	✓	—	—	—	—	—
PXIe-4310	—	—	✓	✓	✓	—	—
PXIe-4322	—	—	—	—	—	✓	—
PXIe-4330	—	—	—	—	—	—	✓
PXIe-4331	—	—	—	—	—	—	✓

## Terminal Blocks (continued)

Description	TB-4339, 120 Ohm 1/4 Bridge, 50K-Ohm Shunt Cal	TB-4339B, 350 Ohm 1/4 Bridge, 100K Ohm Shunt Cal	TB-4339C, 1K Ohm 1/4 Bridge, 100K Ohm Shunt Cal	TB-4340	TB-4353, Isothermal Terminal Block	TC-4353, mini TC Connector Terminal Block	TB-4357
Part Number	783532-01	783533-01	783534-01	784087-01	781349-01	782403-01	782119-01
PXIe-4339	✓	✓	✓	—	—	—	—
PXIe-4340	—	—	—	✓	—	—	—
PXIe-4353	—	—	—	—	✓	✓	—
PXIe-4357	—	—	—	—	—	—	✓

## Rack-Mounts

Rack-Mount	RM-4302	RM-4304	RM-24999	RM-4339, Rackmount TB for PXIe-4339 with in situ calibration	Custom Shunt Calibration Accessory for RM-4339 (SCAL-4339)
Part Number	783872-01	783873-01	785840-01	783535-01	783536-01
PXIe-4302	✓	—	—	—	—
PXIe-4303	✓	—	—	—	—
PXIe-4304	—	✓	—	—	—
PXIe-4305	—	✓	—	—	—
PXIe-4331	—	—	✓	—	—
PXIe-4339	—	—	—	✓	✓

## Cables

Description	SH96-96-2 Cable (1 m)	SH96-96-2 Cable (3 m)	SH96-96-2 Cable (5 m)	SH96F-96M-42 V Shielded Cable for PXIe-4304/5 to Rack-Mount Terminal Block, 1 m	SH96F-96M-42 V Shielded Cable for PXIe-4304/5 to Rack-Mount Terminal Block, 3 m	SH96F-96M-42 V Shielded Cable for PXIe-4304/5 to Rack-Mount Terminal Block, 5 m	SH96-96-1, 1 m	SH96-96-1, 3 m	SH96-96-1, 5 m
Part Number	157350-01	157350-03	157350-05	158228-01	158228-03	158228-05	190668-01	190668-03	190668-05
PXIe-4302	✓	✓	✓	—	—	—	—	—	—
PXIe-4303	✓	✓	✓	—	—	—	—	—	—
PXIe-4304	—	—	—	✓	✓	✓	—	—	—
PXIe-4305	—	—	—	✓	✓	✓	—	—	—
PXIe-4339	✓	✓	✓	—	—	—	—	—	—
PXIe-4353	—	—	—	—	—	—	✓	✓	✓

## Calibration Accessories

Calibration Accessories	CAL-4300B	CAL-4309	CAL-4330	CAL-4353
Part Number	781852-01	784958-01	786988-01	781350-01
PXIe-4300	✓	—	—	—
PXIe-4309	—	✓	—	—
PXIe-4330	—	—	✓	—
PXIe-4353	—	—	—	✓

## Sensors

Sensors	J-Type Fiberglass Thermocouple, 1 m (32 °F to 900 °F)	J-Type Fiberglass Thermocouple, 2 m (32 °F to 900 °F)	K-Type Fiberglass Thermocouple, 1 m (3-2 °F to 900 °F)	K-Type Fiberglass Thermocouple, 2 m (32 °F to 900 °F)	K-Type Thermocouple Wire, 30 m (32 °F to 900 °F)	K-Type Thermocouple Wire, 300 m (32 °F to 900 °F)	T-Type Fiberglass Thermocouple, 2 m (32 °F to 500 °F)	3-Wire, 100 Ω Platinum RTD (Field-Cuttable Probe)
Part Number	745690-J001	745690-J002	745690-K001	745690-K002	745687-K030	745687-K300	745690-T002	745686-01
PXIe-4353	✓	✓	✓	✓	✓	✓	✓	—
PXIe-4357	—	—	—	—	—	—	—	✓



Recommended software (sold separately):

 LabVIEW

 LabVIEW FPGA

Additional resources for software development:

C/C++, Python

## PXI Reconfigurable I/O Module (FPGA)

- Variety of onboard FPGA options
- 12-bit to 18-bit analog input resolution
- Up to 16 analog channels and 96 bidirectional channels
- Up to 1 MS/s analog sample rate

### Key Features:

#### Flexible Functionality

Match individual application requirements to mimic the functionality of fixed I/O devices. You also can use it with software in timing and triggering applications such as control and hardware-in-the-loop (HIL) simulations.

#### Accelerate FPGA Programming

The software behind NI R Series modules gives you the flexibility to implement a custom FPGA design from scratch and the support of starting from a host-based driver.

#### Real-Time Signal Processing

PXI R Series modules have the resources you need to engineer complex algorithms, process data in real time between the I/O and CPU, and deploy your designs to hardware.

## PXI Reconfigurable I/O Modules (FPGA)

Category	Model	Part Number	Analog Input Voltage Range	Digital I/O Logic Levels	Dynamic RAM (DRAM)	FPGA	Max Clock Rate	Max Sample Rate	Channels
Multifunction I/O, General Purpose	PXI-7841	780337-01	-10 V to 10 V	3.3 V 5 V	0 MB	Virtex-5 LX30	40 MHz	200 kS/s	Analog Input: 8 Analog Output: 8 Digital: 96
	PXIe-7846	784143-01	-10 V to 10 V -5 V to 5 V -2 V to 2 V -1 V to 1 V	1.2 V 1.5 V 1.8 V 2.5 V 3.3 V	0 MB	Kintex-7 160T	80 MHz	500 kS/s	Analog Input: 8 Analog Output: 8 Digital: 48
	PXI-7842	780338-01	-10 V to 10 V	3.3 V 5 V	0 MB	Virtex-5 LX50	40 MHz	200 kS/s	Analog Input: 8 Analog Output: 8 Digital: 96
Fast Clock Rate	PXI-7851	780339-01	-10 V to 10 V	3.3 V 5 V	0 MB	Virtex-5 LX30	40 MHz	750 kS/s	Analog Input: 8 Analog Output: 8 Digital: 96
	PXI-7852	780340-01	-10 V to 10 V	3.3 V 5 V	0 MB	Virtex-5 LX50	40 MHz	750 kS/s	Analog Input: 8 Analog Output: 8 Digital: 96
	PXI-7853	780341-01	-10 V to 10 V	3.3 V 5 V	0 MB	Virtex-5 LX85	40 MHz	750 kS/s	Analog Input: 8 Analog Output: 8 Digital: 96
	PXIe-7856	784145-01	-10 V to 10 V -5 V to 5 V -2 V to 2 V -1 V to 1 V	1.2 V 1.5 V 1.8 V 2.5 V 3.3 V	0 MB	Kintex-7 160T	80 MHz	1 MS/s	Analog Input: 8 Analog Output: 8 Digital: 48
	PXI-7854	780342-01	-10 V to 10 V	3.3 V 5 V	0 MB	Virtex-5 LX110	40 MHz	750 kS/s	Analog Input: 8 Analog Output: 8 Digital: 96
Dynamic RAM (DRAM) Available	PXIe-7847	784144-01	-10 V to 10 V -5 V to 5 V -2 V to 2 V -1 V to 1 V	1.2 V 1.5 V 1.8 V 2.5 V 3.3 V	512 MB	Kintex-7 160T	80 MHz	500 kS/s	Analog Input: 8 Analog Output: 8 Digital: 48
	PXIe-7857	784146-01	-10 V to 10 V -5 V to 5 V -2 V to 2 V -1 V to 1 V	1.2 V 1.5 V 1.8 V 2.5 V 3.3 V	512 MB	Kintex-7 160T	80 MHz	1 MS/s	Analog Input: 8 Analog Output: 8 Digital: 48
	PXIe-7861	786671-01	-10 V to 10 V -5 V to 5 V -2 V to 2 V -1 V to 1 V	3.3 V	512 MB	Kintex-7 160T	10 MHz	1 MS/s	Analog Input: 16 Analog Output: 8 Digital: 32
	PXIe-7865	787355-01	-10 V to 10 V -5 V to 5 V -2 V to 2 V -1 V to 1 V	5 V 3.3 V	512 MB	Kintex-7 160T	20 MHz	1 MS/s	Analog Input: 2 Analog Output: 24 Digital: 32
	PXIe-7867	785570-01	-10 V to 10 V -5 V to 5 V -2 V to 2 V -1 V to 1 V	3.3 V	512 MB	Kintex-7 160T	80 MHz	1 MS/s	Analog Input: 6 Analog Output: 18 Digital: 48
	PXIe-7868	785571-01	-10 V to 10 V -5 V to 5 V -2 V to 2 V -1 V to 1 V	3.3 V	512 MB	Kintex-7 325T	80 MHz	1 MS/s	Analog Input: 6 Analog Output: 18 Digital: 48
Dynamic RAM (DRAM) Available, Largest FPGA	PXIe-7862	786672-01	-10 V to 10 V -5 V to 5 V -2 V to 2 V -1 V to 1 V	3.3 V	512 MB	Kintex-7 325T	10 MHz	1 MS/s	Analog Input: 16 Analog Output: 8 Digital: 32
	PXIe-7866	787354-01	-10 V to 10 V -5 V to 5 V -2 V to 2 V -1 V to 1 V	3.3 V 5 V	512 MB	Kintex-7 325T	20 MHz	1 MS/s	Analog Input: 2 Analog Output: 24 Digital: 32
	PXIe-7858	784147-01	-10 V to 10 V -5 V to 5 V -2 V to 2 V -1 V to 1 V	1.2 V 1.5 V 1.8 V 2.5 V 3.3 V	512 MB	Kintex-7 325T	80 MHz	1 MS/s	Analog Input: 8 Analog Output: 8 Digital: 48

## PXI Reconfigurable I/O Accessories (FPGA)

### Cables



Cables	SHC68-68-RDIO Cable, 68-Pos .50 Series D-Type To 68-Pos VHDCI Offset, 1 m	SHC68-68-RMIO Cable, 68-Pos .50 Series D-Type To 68-Pos VHDCI Offset, 1 m	SHC68-68-RMIO Cable, 68-Pos .50 Series D-Type To 68-Pos VHDCI Offset, 2 m	Shielded R Series High-Speed Digital Cable, 2 m	Shielded R Series High-Speed Digital Cable, 1 m
Part Number	191667-01	189588-01	189588-02	156166-02	156166-01
PXI-7841	✓	✓	✓	—	—
PXI-7842	✓	✓	✓	—	—
PXI-7851	✓	✓	✓	—	—
PXI-7852	✓	✓	✓	—	—
PXI-7853	✓	✓	✓	—	—
PXI-7854	✓	✓	✓	—	—
PXIe-7846	—	✓	✓	✓	✓
PXIe-7847	—	✓	✓	✓	✓
PXIe-7856	—	✓	✓	✓	✓
PXIe-7857	—	✓	✓	✓	✓
PXIe-7858	—	✓	✓	✓	✓
PXIe-7861	—	✓	✓	✓	✓
PXIe-7862	—	✓	✓	✓	✓
PXIe-7865	—	✓	✓	✓	✓
PXIe-7866	—	✓	✓	✓	✓
PXIe-7867	—	✓	✓	✓	✓
PXIe-7868	—	✓	✓	✓	✓

### Connector Block

Model	SCB-68A Shielded Connector Block	SCB-68 HSDIO, Shielded 68-Pin Connector Block
Part Number	782536-01	782914-01
PXI-7841	✓	—
PXI-7842	✓	—
PXI-7851	✓	—
PXI-7852	✓	—
PXI-7853	✓	—
PXI-7854	✓	—
PXIe-7846	✓	✓
PXIe-7847	✓	✓
PXIe-7856	✓	✓
PXIe-7857	✓	✓
PXIe-7858	✓	✓
PXIe-7861	✓	✓
PXIe-7862	✓	✓
PXIe-7865	✓	✓
PXIe-7866	✓	✓
PXIe-7867	✓	✓
PXIe-7868	✓	✓



Recommended software (sold separately):

-  LabVIEW
-  LabVIEW Real-Time Module
-  LabVIEW FPGA

Additional resources for software development:

- C/C++, Python,
-  LabWindows/CVI

## PXI NI FlexRIO

Analog I/O up to 6.4 GS/s, digital I/O up to 1.25 Gbps, RF I/O up to 4.4 GHz  
 High-performance Xilinx FPGAs with up to 20 GB of onboard DRAM  
 Program with LabVIEW FPGA or Xilinx Vivado  
 Develop application-specific I/O with the FlexRIO Module Development Kit

### Key Features:

#### Leverage Rapidly Evolving Technology

FlexRIO provides the latest high-speed converter and FPGA technologies before they are widely available in commercial instruments. You can use FlexRIO to develop applications that push the requirements for sample rate, bandwidth, resolution, and channel count.

#### Accelerate FPGA Programming

LabVIEW FPGA is a powerful tool for designing and implementing custom hardware circuits that can provide high-speed and low-latency processing for a wide range of applications.

#### Process Signals in Real Time

FlexRIO can help you keep up with faster converters. Modules from the Xilinx Kintex UltraScale FPGA to the Xilinx Virtex UltraScale+ VU11P FPGA, paired with LabVIEW FPGA, provide the resources you need to engineer complex algorithms, process data in real time between the I/O and CPU, and deploy your designs to hardware.

### FPGA Modules for FlexRIO

Selection Guide	Model	Part Number	FPGA	FPGA Slices	FPGA DSP Slices	FPGA Block RAM (Kb)	Onboard Memory	Streaming Throughput
Highest Performance	<a href="#">PXIe-7976</a>	783625-01	Kintex 7 K410T	63,550	1,540	28,620	2 GB	3.2 GB/s
Larger FPGA	<a href="#">PXIe-7975</a>	782955-01	Kintex 7 K410T	63,550	1,540	28,620	2 GB	1.7 GB/s
Lower Cost with DRAM	<a href="#">PXIe-7972</a>	782954-01	Kintex 7 K325T	50,950	840	16,020	2 GB	1.7 GB/s
Lowest Cost	<a href="#">PXIe-7971</a>	782953-01	Kintex 7 K325T	50,950	840	16,020	0 GB	1.7 GB/s



## FPGA Modules and Adapter Module Compatibility

### Adapter Module Compatibility

Adapter Module Type	FlexRIO Digitizer Adapter Modules					FlexRIO Signal Generator Adapter Modules	
Model	NI-5734	NI-5751B	NI-5752B	NI-5771	NI-5772	AT-1120	AT-1212
PXIe-7976	✓	✓	✓	✓	✓	✓	✓
PXIe-7975	✓	✓	✓	✓	✓	✓	✓
PXIe-7972	✓	✓	✓	✓	✓	✓	✓
PXIe-7971	✓	✓	✓	✓	✓	✓	✓

### Adapter Module Compatibility (continued)

Adapter Module Type	FlexRIO Digital Adapter Modules					FlexRIO Transceiver Adapter Modules	FlexRIO RF Adapter Modules	FlexRIO Camera Link Adapter Modules
Model	NI-6581B	NI-6583	NI-6584	NI-6585B	NI-6589	NI-5783	NI-5791	NI-1483
PXIe-7976	✓	✓	✓	✓	✓	✓	✓	✓
PXIe-7975	✓	✓	✓	✓	✓	✓	✓	✓
PXIe-7972	✓	✓	✓	✓	✓	✓	✓	✓
PXIe-7971	✓	✓	✓	✓	✓	✓	✓	✓

### FlexRIO Digitizers Adapter Modules

Selection Guide	Model	Part Number	Compatible FPGA	Resolution	Channels	Maximum Sample Rate	Maximum Bandwidth	Coupling	Full-Scale Input Range	Connectivity
High-Resolution FlexRIO Digitizer FAM	<b>NI-5734</b>	781659-04	Refer to FPGA Modules for FlexRIO	16	4	120 MS/s	117 MHz	AC and DC	2 Vpp	BNC
High-Density FlexRIO Digitizer FAMs	<b>NI-5751B</b>	784061-01	Refer to FPGA Modules for FlexRIO	14	16	50 MS/s	26 MHz	DC	2 Vpp	VHDCI
	<b>NI-5752B</b>	784062-01	Refer to FPGA Modules for FlexRIO	12	32	50 MS/s	14 MHz	AC	2 Vpp	VHDCI
Wide-Bandwidth FlexRIO Digitizer FAMs	<b>NI-5771</b>	781419-02	Refer to FPGA Modules for FlexRIO	8	2	3 GS/s	900 MHz	DC	1.3 Vpp	SMA
	<b>NI-5772</b>	782097-01	Refer to FPGA Modules for FlexRIO	12	2	1.6 GS/s	2.2 GHz	AC	2 Vpp	SMA
		782097-02	Refer to FPGA Modules for FlexRIO	12	2	1.6 GS/s	2.2 GHz	DC	2 Vpp	SMA

## FlexRIO Digitizer Adapter Modules Accessories

### Cables

Cables	BNC Male (Plug) To BNC Male (Plug), 75 Ω, 2 m Cables, 4-Pack	SHH19-H19-AUX Shielded Single-Ended Cable For Aux Digital I/O With Jackscrew, 2 m	SHC68-C68-D4 Shielded Single-Ended Cable, Lower DC Resistance, 3 m	SHC68-C68-D4 Shielded Single-Ended Cable, Low Leakage, 1 m	SHC68-C68-D4 Shielded Single-Ended Cable, 1 m	SHC68-C68-D4 Shielded Single-Ended Cable, 0.55 m	SHC68-C68-D4 Shielded Single-Ended Cable, 2 m	SHC68-C68-D3, Male VHDCI To Male VHDCI, Shielded LVDS Cable, 1 m	Shc68-C68-D3, Male VHDCI To Male VHDCI, Shielded LVDS Cable, 2 m
Part Number	779697-02	152629-02	132625-03	152870-01	196275-01	781013-01	781293-01	188143-01	788905-02
NI-5734	✓	✓	—	—	—	—	—	—	—
NI-5751B	—	—	✓	✓	✓	✓	✓	—	—
NI-5752B	—	—	✓	✓	✓	✓	✓	✓	✓
NI-5771	—	✓	—	—	—	—	—	—	—
NI-5772	—	✓	—	—	—	—	—	—	—

### Connector Block

Connector Blocks	SCB-19 Noise-Rejecting, Shielded AUX I/O Connector Block	SMB-2147 16-Channel Analog Input Accessory	SMB-2146 2-Ch Input, 16-Channel Output Digital I/O Accessory	SMB-2145 16-Channel Analog Input Accessory
Part Number	782444-01	781518-01	781517-01	781516-01
NI-5734	✓	—	—	—
NI-5751B	—	✓	—	—
NI-5752B	—	—	✓	✓
NI-5771	✓	—	—	—
NI-5772	✓	—	—	—

## FlexRIO Digitizers With Integrated I/O Modules

Selection Guide	Model	Part Number	Analog Input Bandwidth	Analog Input Coupling	Analog Input Resolution	Analog Input Voltage Range	CableSense™	Dynamic RAM (DRAM)	FPGA	Max Sample Rate	Voltage Input Channels
High-Resolution Integrated FlexRIO Digitizer	PXIe-5763	785160-01	225 MHz	AC	16 Bits	-1 V to 1 V	—	0 GB	Kintex UltraScale KU035	500 MS/s	4
		785161-01	225 MHz	AC	16 Bits	-1 V to 1 V	—	4 GB	Kintex UltraScale KU040	500 MS/s	4
		785162-01	225 MHz	AC	16 Bits	-1 V to 1 V	—	4 GB	Kintex UltraScale KU060	500 MS/s	4
		785163-01	225 MHz	DC	16 Bits	-1 V to 1 V	—	0 GB	Kintex UltraScale KU035	500 MS/s	4
		785164-01	225 MHz	DC	16 Bits	-1 V to 1 V	—	4 GB	Kintex UltraScale KU040	500 MS/s	4
		785165-01	225 MHz	DC	16 Bits	-1 V to 1 V	—	4 GB	Kintex UltraScale KU060	500 MS/s	4
	PXIe-5764	785166-01	1.15 GHz	AC	16 Bits	-1 V to 1 V	—	0 GB	Kintex UltraScale KU035	1 GS/s	4
		785167-01	1.15 GHz	AC	16 Bits	-1 V to 1 V	—	4 GB	Kintex UltraScale KU040	1 GS/s	4
		785168-01	1.15 GHz	AC	16 Bits	-1 V to 1 V	—	4 GB	Kintex UltraScale KU060	1 GS/s	4
		785169-01	400 MHz	DC	16 Bits	-1 V to 1 V	—	0 GB	Kintex UltraScale KU035	1 GS/s	4
		785170-01	400 MHz	DC	16 Bits	-1 V to 1 V	—	4 GB	Kintex UltraScale KU040	1 GS/s	4
		785171-01	400 MHz	DC	16 Bits	-1 V to 1 V	—	4 GB	Kintex UltraScale KU060	1 GS/s	4
High-Bandwidth Integrated FlexRIO Digitizers	PXIe-5774	785646-01	3 GHz	DC	12 Bits	200 mVpp 1 Vpp	—	4 GB	Kintex UltraScale KU040	6.4 GS/s	2
		785646-02	1.6 GHz	DC	12 Bits	200 mVpp 1 Vpp	—	4 GB	Kintex UltraScale KU040	6.4 GS/s	2
		785647-01	3 GHz	DC	12 Bits	200 mVpp 1 Vpp	—	4 GB	Kintex UltraScale KU060	6.4 GS/s	2
		785647-02	1.6 GHz	DC	12 Bits	200 mVpp 1 Vpp	—	4 GB	Kintex UltraScale KU060	6.4 GS/s	2
		785647-11	3 GHz	DC	12 Bits	200 mVpp to 1 Vpp	✓	4 GB	Kintex UltraScale KU060	6.4 GS/s	2
		785647-12	1.6 GHz	DC	12 Bits	200 mVpp to 1 Vpp	✓	4 GB	Kintex UltraScale KU060	6.4 GS/s	2
	PXIe-5775	785590-01	6 GHz	AC	12 Bits	1.25 Vpp	—	0 GB	Kintex UltraScale KU035	6.4 GS/s	2
		785591-01	6 GHz	AC	12 Bits	1.25 Vpp	—	4 GB	Kintex UltraScale KU040	6.4 GS/s	2
		785592-01	6 GHz	AC	12 Bits	1.25 Vpp	—	4 GB	Kintex UltraScale KU060	6.4 GS/s	2

## FlexRIO Digitizers With Integrated I/O Accessories

### Connector Block

	SCB-12, Nano-Pitch Connector Block, 8 SE DIO, 1 QSFP+	SCB-8 Noise-Rejecting, Shielded Nano-Pitch Connector Block
Part Number	787419-01	786335-01
PXIe-5763	✓	✓
PXIe-5764	✓	✓
PXIe-5774	✓	✓
PXIe-5775	✓	✓

### FlexRIO Signal Generator Adapter Modules

Selection Guide	Model	Part Number	Compatible FPGA	Resolution (Bits)	Channels	Maximum Sample Rate	Maximum Bandwidth	Coupling	Signaling	Connectivity
High-Speed FlexRIO Signal-Generator FAMS	AT-1120	782248-01	Refer to FPGA Modules for FlexRIO	14	1	2 GS/s	550 MHz	DC	Differential	SMA
	AT-1212	782248-02	Refer to FPGA Modules for FlexRIO	14	2	1.25 GS/s	400 MHz	DC	Differential	SMA

### FlexRIO Signal Generator Adapter Modules Accessories

#### Cables

Cables	SMA Male to SMA Male Cable, 50 $\Omega$ , 38.1 cm	SMA Male to SMA Male Cable, 50 $\Omega$ , 12.7 cm	SMA Male to SMA Male Cable for USRP, 50 $\Omega$ , 2 m	SMA Male to SMA Male Cable, 50 $\Omega$ , 30 cm
Part Number	763444-01	763443-01	783470-01	781846-01
AT-1120	✓	✓	✓	✓
AT-1212	✓	✓	✓	✓

### FlexRIO Signal Generator Integrated I/O Modules

Selection Guide	Model	Part Number	FPGA	Reconstruction Filter	Resolution (Bits)	Channels	Maximum Sample Rate	Maximum Bandwidth	Coupling	Signaling	Connectivity
High-Speed Integrated FlexRIO Signal Generator	PXIe-5745	785596-01	Kintex UltraScale KU035	—	12	2	3.2 GS/s per Channel	2.9 GHz	AC	Single-Ended	SMA
		785596-02	Kintex UltraScale KU035	✓	12	2	3.2 GS/s per Channel	2.9 GHz	AC	Single-Ended	SMA
		785597-01	Kintex UltraScale KU040	—	12	2	3.2 GS/s per Channel	2.9 GHz	AC	Single-Ended	SMA
		785597-02	Kintex UltraScale KU040	✓	12	2	3.2 GS/s per Channel	2.9 GHz	AC	Single-Ended	SMA
		785598-01	Kintex UltraScale KU060	—	12	2	3.2 GS/s per Channel	2.9 GHz	AC	Single-Ended	SMA
		785598-02	Kintex UltraScale KU060	✓	12	2	3.2 GS/s per Channel	2.9 GHz	AC	Single-Ended	SMA

## FlexRIO Signal Generator Integrated I/O Module Accessories

### Connector Blocks

Connector Block	SCB-12, Nano-Pitch Connector Block, 8 SE DIO, 1 QSFP+	SCB-8 Noise-Rejecting, Shielded Nano-Pitch Connector Block
Part Number	787419-01	786335-01
PXIe-5745	✓	✓

### FlexRIO Digital Adapter Modules

Selection Guide	Model	Part Number	Compatible FPGA	Digital I/O Termination	Duplex	Logic Levels And Range	Max Clock Rate	Max Data Rate	Number of Bidirectional Digital Channels	Signaling Type
General Purpose	<b>NI-6581B</b>	783887-01	Refer to FPGA Modules for FlexRIO	50 Ω	—	1.8 V 2.5 V 3.3 V	100 MHz	100 Mb/s	54	Single-Ended
General Purpose + LVDS	<b>NI-6583</b>	781320-01	Refer to FPGA Modules for FlexRIO	50 Ω	—	LVDS Programmable 1.2 V—3.3 V	200 MHz	300 Mb/s	32	Single-Ended Differential
		781320-02	Refer to FPGA Modules for FlexRIO	50 Ω	—	mLVDS Programmable 1.2 V—3.3 V	200 MHz	300 Mb/s	32	Single-Ended Differential
RS422 and RS485	<b>NI-6584</b>	781290-01	Refer to FPGA Modules for FlexRIO	100 Ω	Half Duplex	RS422/RS485	16 MHz	16 Mb/s	16	Differential
		781290-02	Refer to FPGA Modules for FlexRIO	100 Ω	Full Duplex	RS422/RS485	16 MHz	16 Mb/s	16	Differential
		781290-03	Refer to FPGA Modules for FlexRIO	N/A, External Termination Recommended	Full Duplex	RS422/RS485	16 MHz	16 Mb/s	16	Differential
LVDS	<b>NI-6585B</b>	784060-01	Refer to FPGA Modules for FlexRIO	100 Ω	—	LVDS	200 MHz	300 Mb/s	32	Differential
LVDS	<b>NI-6589</b>	783888-01	Refer to FPGA Modules for FlexRIO	100 Ω	—	LVDS	1 GHz	1 Gb/s	20	Differential

## FlexRIO Digital Adapter Module Accessories

### Cables

Cable	C68-C68-D4 Unshielded Cable For High-Speed Digital I/O, 2X 68-Position VHDCI Offset, 1 m	SHC68-C68-D4 Shielded Single-Ended Cable, Lower DC Resistance, 3 m	SHC68-C68-D4 Shielded Single-Ended Cable, Low Leakage, 1 m	SHC68-C68-D4 Shielded Single-Ended Cable, 1 m	SHC68-C68-D4 Shielded Single-Ended Cable, 0.55 m	SHC68-C68-D4 Shielded Single-Ended Cable, 2 m	C68-C68-D4 Unshielded Cable For High-Speed Digital I/O, 2X 68-Position VHDCI Offset, 1 m
Part Number	195949-01	132625-03	152870-01	196275-01	781013-01	781293-01	195949-01
NI-6581B	✓	✓	✓	✓	✓	✓	✓
NI-6583	✓	✓	✓	✓	✓	✓	✓
NI-6584	✓	✓	✓	✓	✓	✓	✓
NI-6585B	—	—	—	—	—	—	—
NI-6589	—	—	—	—	—	—	—

### Cables (continued)

Cable	SHB12X-B12X, Male InfiniBand to Male Infiniband, Shielded LVDS Cable, 1 m	SHB12X-B12X, Male InfiniBand to Male Infiniband, Shielded LVDS Cable, 2 m	SHB12X-H3X24, Male InfiniBand to Differential Flying Leads, Shielded LVDS Cable, 1.5 m	BNC Male (Plug) to BNC Male (Plug), 75 Ω, 2 m Cables, 4 Pack	SHC68-C68-D3, Male VHDCI to Male VHDCI, Shielded LVDS Cable, 1 m	SHC68-C68-D3, Male VHDCI to Male VHDCI, Shielded LVDS Cable, 2 m	68 Pos VHDCI Connector to Eight 9 POS D-SUB, RS485, 1 m
Part Number	192344-01	192344-02	196236-1R5	779697-02	188143-01	788905-02	197546-01
NI-6581B	—	—	—	—	—	—	—
NI-6583	✓	✓	✓	—	—	—	—
NI-6584	—	—	—	✓	—	—	✓
NI-6585B	—	—	—	—	✓	✓	—
NI-6589	✓	✓	✓	—	—	—	—

### Breakout Boxes and Adapters

Breakout Boxes and Adapters	CB-2162 Single-Ended Digital I/O Accessory	SMB-2163 Single-Ended Digital I/O Accessory (Rack-Mountable)	SMA-2164 LVDS Prototyping Accessory	SMA-2165 Prototyping Accessory For NI 6585	SCB-68 HSDIO, Shielded 68-Pin Connector Block
Part Number	778592-01	778747-01	779323-01	782092-01	782914-01
NI-6581B	✓	✓	—	—	✓
NI-6583	✓	✓	✓	—	✓
NI-6584	✓	✓	—	—	✓
NI-6585B	—	—	—	✓	—
NI-6589	—	—	✓	—	—

## FlexRIO Digital Integrated I/O Modules

Selection Guide	Model	Part Number	FPGA	Logic Levels And Range	Digital Input Only Channels	Digital Output Only Channels	Max Data Rate
LVDS FlexRIO Digital I/O Module	PXIe-6569	787280-01	Kintex UltraScale KU035	LVDS	32	32	300 Mb/s
		787281-01	Kintex UltraScale KU060	LVDS	—	64	300 Mb/s
		787282-01	Kintex UltraScale KU060	LVDS	64	0	300 Mb/s
		787283-01	Kintex UltraScale KU060	LVDS	32	32	300 Mb/s
		787284-01	Kintex UltraScale KU035	LVDS	0	64	300 Mb/s
		787285-01	Kintex UltraScale KU035	LVDS	64	0	300 Mb/s

## FlexRIO Digital Integrated I/O Module Accessories

### Cables

Cable	MINI-SAS HD Breakout Cable To 16 SMA	SR240M-SR240M Cable, LVDS With SE, 1 m	SR240M-SR240M Cable, LVDS With SE, 0.5 m
Part Number	788260-01	787317-01	787317-0R5
PXIe-6569	✓	✓	✓

### Terminal Block

Terminal Block	TB-6569 High Speed Searay To Mini-SAS HD Breakout
Part Number	788259-01
PXIe-6569	✓

## FlexRIO Transceiver Adapter Modules

Selection Guide	Model	Part Number	Available Filters	Analog Input Sampling Rate	Compatible FPGA	IF Transceiver Max Bandwidth	Input Coupling	Max Analog Output Update Rate	Analog Input Channels	Analog Output Channels	Resolution
40 MHz Bandwidth Transceiver Adapter Module for FlexRIO	NI-5783	784364-01	Elliptic	100 MS/s	Refer to FPGA Modules for FlexRIO	175 MHz	DC	400 MS/s	4	4	16
		784364-02	Butterworth	100 MS/s	Refer to FPGA Modules for FlexRIO	175 MHz	DC	400 MS/s	4	4	16

## FlexRIO Transceiver Adapter Module Accessories

### Cables

Cable	HD BNC Male to Bnc Female Cable, 50 $\Omega$ , 20 cm	HD BNC To SMA Cable, 50 $\Omega$ , 1 m	SHH19-H19-Aux Shielded Single-Ended Cable For Aux Digital I/O With Jackscrew, 2 m
Part Number	787230-0R2	784995-01	152629-02
NI-5783	✓	✓	✓

### Digital Cables

Digital Cable	SHH19-H19-AUX Shielded Single-Ended Cable, 2 m
Part Number	152629-02
NI-5783	✓

### Connector Blocks

Connector Block	SCB-19 Noise-Rejecting, Shielded Aux I/O Connector Block
Part Number	782444-01
NI-5783	✓

## FlexRIO Transceiver Integrated I/O Modules

Selection Guide	Model	Part Number	FPGA	Dynamic RAM (DRAM)	Analog Output Bandwidth	Reconstruction Filter	Channels	Max Input Sample Rate	Max Output Sample Rate	Coupling	Resolution
12-Bit, 6.4 GS/s, 2-Channel PXI FlexRIO IF Transceiver	PXIe-5785	785584-01	Kintex UltraScale KU035	0 GB	2.9 GHz	—	2 AI, 2 AO	6.4 GS/s	3.2 GS/s	AC	12
		785584-02	Kintex UltraScale KU035	0 GB	2.4 GHz	✓	2 AI, 2 AO	6.4 GS/s	3.2 GS/s	AC	12
		785585-01	Kintex UltraScale KU040	4 GB	2.9 GHz	—	2 AI, 2 AO	6.4 GS/s	3.2 GS/s	AC	12
		785585-02	Kintex UltraScale KU040	4 GB	2.4 GHz	✓	2 AI, 2 AO	6.4 GS/s	3.2 GS/s	AC	12
		785586-01	Kintex UltraScale KU060	4 GB	2.9 GHz	—	2 AI, 2 AO	6.4 GS/s	3.2 GS/s	AC	12
		785586-02	Kintex UltraScale KU060	4 GB	2.4 GHz	✓	2 AI, 2 AO	6.4 GS/s	3.2 GS/s	AC	12



## FlexRIO Transceiver Integrated I/O Module Accessories

### Cables

Description	Nano-Pitch Male to Nano-Pitch Male OCuLink x4 Cable, 1 m	SMA Male to SMA Male Cable, 50 Ω, 30 cm	SMA Male to SMA Male Cable, 50 Ω, 1 m
Part Number	785486-01	781846-01	781845-01
PXIe-5785	✓	✓	✓

### Connector Block

Description	SCB-12, Nano-Pitch Connector Block, 8 SE DIO, 1 QSFP+	SCB-8 Noise-Rejecting, Shielded Nano-Pitch Connector Block
Part Number	787419-01	786335-01
PXIe-5785	✓	✓

## FlexRIO RF Adapter Modules

Selection Guide	Model	Part Number	Input Noise Density	Max Input Power	Max Output Power	RF Analyzer Instantaneous Band	RF Generator Frequency Range	RF Generator Instantaneous Band	Compatible FPGA
100 MHz Bandwidth, 200 MHz to 4.4 GHz, RF Adapter Module for FlexRIO	<b>NI-5791</b>	782510-01	-148 dBm/Hz	20 dBm	8 dBm	100 MHz	200 MHz to 4.4 GHz	100 MHz	Refer to FPGA Modules for FlexRIO

## FlexRIO RF Adapter Module Accessories

### Cables

Description	SMA Male to SMA Male Cable, 50 Ω, 30 cm	SMA Male to SMA Male Cable, 50 Ω, 1 m
Part Number	781846-01	781845-01
NI-5791	✓	✓

## FlexRIO Camera Link Adapter Modules

Selection Guide	Model	Part Number	Supported Configurations	Connector	Supported Pixel Clock Frequency	Aux I/O	Compatible FPGA
Full-Configuration Camera Link Adapter Module for FlexRIO	<b>NI-1483</b>	781341-01	Base, Medium, Full Camera Link	2x 26-Pin SDR	20–85 MHz	4x TTL, 2x Isolated Digital Inputs, 1x Quadrature Encoder	Refer to FPGA Modules for FlexRIO

## FlexRIO Camera Link Adapter Module Accessories

### Cables

Description	Cable, Power Over Camera Link (PoCL), MDR To MDR, 2 m	Cable, Power Over Camera Link( PoCL), MDR To MDR, 5 m	Cable, Power Over Camera Link( PoCL), MDR To SDR, 5 m	Cable, Power Over Camera Link (PoCL), SDR To SDR, 5 m
Part Number	199744-02	199744-05	199745-05	199746-05
NI-1483	✓	✓	✓	✓

## FlexRIO Coprocessor Modules

Selection Guide	Model	Part Number	I/O	Block RAM	DSP Slices	Dynamic RAM	FPGA	Max Line Rate
Highest Throughput and Largest FPGA	<b>PXIE-7903</b>	788917-01	48 HSS MGTs 8 GPIO	341 Mb	9216	20 GB	Virtex UltraScale+ XCVU11P	28.2 Gb/s
Lowest Cost	<b>PXIE-7912</b>	785173-01	4 HSS MGTs 8 GPIO	21 Mb	1920	4 GB	Kintex UltraScale KU040	16.375 Gb/s
Low Cost	<b>PXIE-7915</b>	785174-01	4 HSS MGTs 8 GPIO	38 Mb	2760	4 GB	Kintex UltraScale KU060	16.375 Gb/s

## FlexRIO Coprocessor Module Accessories

### Cables

Description	Nano-Pitch Male to Nano-Pitch Male OCuLink x4 Cable, 1 m	Nano-Pitch Male to Mini-SAS HD Male OCuLink x4 Cable, 1 m
Part Number	785486-01	786215-01
PXIE-7912	✓	✓
PXIE-7915	✓	✓

### Connector Blocks

Description	SCB-12, Nano-Pitch Connector Block, 8 SE DIO, 1 QSFP+	SCB-8 Noise-Rejecting, Shielded Nano-Pitch Connector Block
Part Number	787419-01	786335-01
PXIE-7912	✓	✓
PXIE-7915	✓	✓

## FlexRIO Camera Interface Modules

Selection Guide	Model	Part Number	Deserializer	Digital Input-Only Channels	Digital Output-Only Channels	Serial Link	Serializer	Supported Modes	FPGA	
8-Channel GMSL2 Automotive Camera Interface Module	PXIe-1487	787456-01	MAX9296A	8	0	GMSL2	—	Pixel	Kintex UltraScale+ KU11P	
		787457-01	MAX9296A	4	4	GMSL2	MAX9295A	Pixel	Kintex UltraScale+ KU11P	
		787458-01	—	—	0	8	GMSL2	MAX9295A	Pixel	Kintex UltraScale+ KU11P
		788714-01	MAX96716A	4	4	GMSL2	MAX96717	Pixel Tunneling	Kintex UltraScale+ KU11P	
		788715-01	—	—	0	8	GMSL2	MAX96717	Pixel Tunneling	Kintex UltraScale+ KU11P
		788716-01	MAX96716A	8	0	GMSL2	—	Pixel Tunneling	Kintex UltraScale+ KU11P	
		788719-01	—	—	0	8	GMSL2	MAX96717F	Pixel Tunneling	Kintex UltraScale+ KU11P
		788781-01	MAX96716A	4	4	GMSL2	MAX96717F	Pixel Tunneling	Kintex UltraScale+ KU11P	
4-Channel GMSL3 Automotive Camera Interface Module	PXIe-1489	788355-01	MAX96792A	4	0	GMSL3	—	Pixel Tunneling	Kintex UltraScale+ KU11P	
		788356-01	MAX96792A	2	2	GMSL3	MAX96793	Pixel Tunneling	Kintex UltraScale+ KU11P	
		788357-01	—	—	0	4	GMSL3	MAX96793	Pixel Tunneling	Kintex UltraScale+ KU11P
8-Channel FPD-LINK III Automotive Camera Interface Module	PXIe-1486	787453-01	DS90UB954	8	0	FPD-LINK III	—	—	Kintex UltraScale+ KU11P	
		787454-01	DS90UB954	4	4	FPD-LINK III	DS90UB953	—	Kintex UltraScale+ KU11P	
		787455-01	—	—	0	8	FPD-LINK III	DS90UB9702	—	Kintex UltraScale+ KU11P
		788711-01	DS90UB638	8	0	FPD-LINK III	—	—	Kintex UltraScale+ KU11P	
		788712-01	DS90UB638	4	4	FPD-LINK III	DS90UB635	—	Kintex UltraScale+ KU11P	
		788713-01	—	—	0	8	FPD-LINK III	DS90UB635	—	Kintex UltraScale+ KU11P
8-Channel FPD-LINK IV Automotive Camera Interface Module	PXIe-1488	788350-01	DS90UB791	8	0	FPD-LINK IV	—	—	Kintex UltraScale+ KU11P	
		788351-01	DS90UB9702	4	4	FPD-LINK IV	DS90UB791	—	Kintex UltraScale+ KU11P	
		788352-01	—	—	0	8	FPD-LINK IV	DS90UB9702	—	Kintex UltraScale+ KU11P

# PXI DAQ

## PXI Analog I/O

- Analog input modules
- Analog output modules
- Displacement input modules
- Strain/bridge input modules
- Temperature input modules

## PXI Digital I/O

- Acquire and generate digital signals and patterns at multiple logic levels
- Characterize circuits, toggle control lines, and meet many other digital application needs

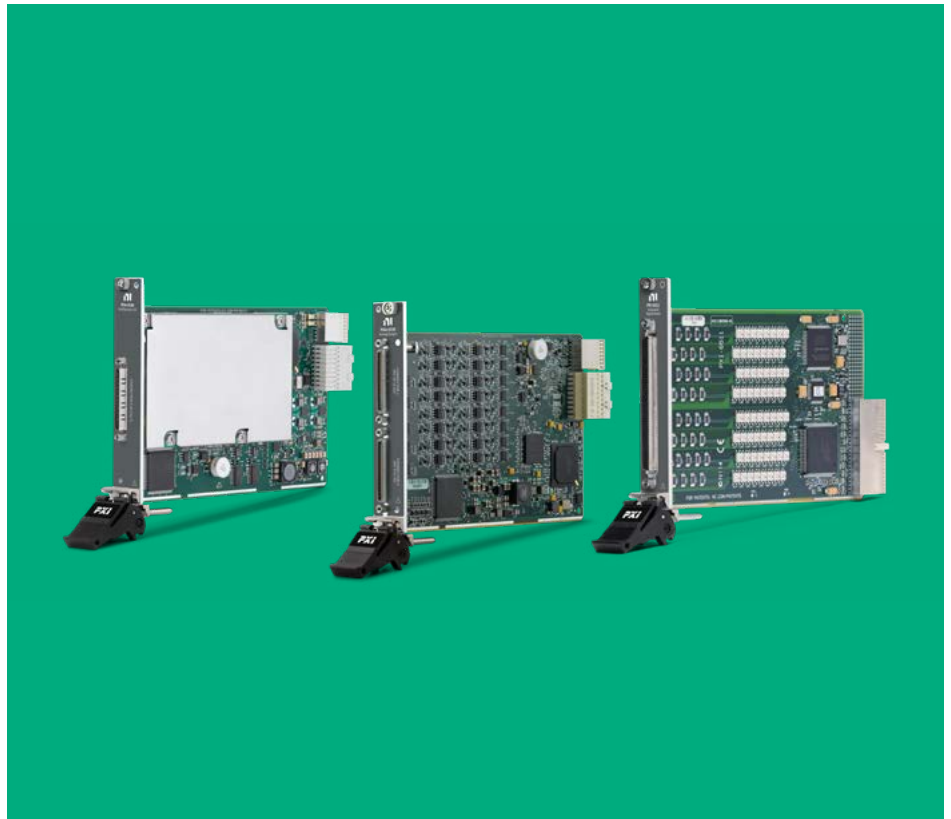

## PXI Multifunction I/O

- Voltage measurements up to 10 MS/s per channel
- Analog, digital and counter/timer I/O in one device
- Multiplexed or simultaneous analog architectures
- Software-selectable input ranges and input channel isolation available
- Up to four analog output channels and four counters/timers

### Key Features:

#### High-Resolution, High-Accuracy Measurements

NI PXI DAQ modules have been meticulously designed, tested, and calibrated to achieve the highest possible accuracy across all input channels.

#### Advanced Timing Technology

Much of the PXI multifunction I/O module family provides up to four enhanced counters, a 100 MHz timebase, and additional options for native, advanced I/O timing and triggering.

#### A Family of Products Built around Flexibility

Because measurement requirements vary significantly from one application to the next, the PXI platform's modularity makes custom hardware configuration easy. Furthermore, the breadth of specification options for PXI data acquisition modules covers a wide swath of circumstances.

Recommended software (sold separately):

 LabVIEW

Additional resources for software development:

C/C++, C#, Python,  
 LabWindows/CVI

## Analog Output Modules

Category	Model	Part Number	Analog Output Resolution	Analog Output Voltage Range	Bus Connector	Max Update Rate	Analog Output Channels	Output Current Range
General Purpose	<b>PXI-6704</b>	777796-01	16 Bits	-10.1 V to 10.1 V	PXI Hybrid	Static	32	0.1 mA to 20.2 mA
Lowest Cost	<b>PXI-6723</b>	778998-01	13 Bits	-10 V to 10 V	PXI Hybrid	800 kS/s	32	—
Fastest Update Rate	<b>PXI-6733</b>	778512-01	16 Bits	-10 V to 10 V	PXI Hybrid	1 MS/s	8	—
	<b>PXIe-6738</b>	783800-01	16 Bits	-10 V to 10 V	PXI Express	1 MS/s	32	—
Highest Channel Count and Fastest Update Rate	<b>PXIe-6739</b>	783801-01	16 Bits	-10 V to 10 V	PXI Express	1 MS/s	64	—

## Analog Output Accessories

### Connector Block

Model	CB-68LP Connector Block	CB-68LPRI/O Connector Block	SCB-68A Shielded Connector Block	TBX-68 Connector Block	BNC-2110 Noise-Rejecting, Shielded BNC Connector Block
Part Number	777145-01	777145-02	782536-01	777141-01	777643-01
PXI-6704	✓	✓	✓	✓	—
PXI-6723	✓	✓	✓	✓	✓
PXI-6733	✓	✓	✓	✓	✓
PXIe-6738	✓	✓	✓	✓	—
PXIe-6739	✓	✓	✓	✓	—

### Cables

Model	Cable Assembly, Type SH6868-D1, 1 m	Cable Assembly, Type SH6868-D1, 2 m	Cable Assembly, Type SH6868-D1, 5 m	Cable Assembly, Type SH6868-D1, 0.4 m	Cable Assembly, Type SH6868-D1, 10 m	Kit, Cable Assembly, 2X 68-Pos Series D-Type, Type SH68-68-EPM, 1 m	Kit, Cable Assembly, 2X 68-Pos Series D-Type, Type SH68-68-EPM, 2 m
Part Number	183432-01	183432-02	183432-05	183432-0R4	183432-10	199006-01	199006-02
PXI-6704	✓	✓	✓	✓	✓	—	—
PXI-6723	—	—	—	—	—	—	—
PXI-6733	—	—	—	—	—	✓	✓
PXIe-6738	—	—	—	—	—	—	—
PXIe-6739	—	—	—	—	—	—	—

## Cables (continued)

Model	Kit, Cable Assembly, 2X 68-Pos Series D-Type, Type SH68-68-EPM, 5 m	SH68-68-EPM Shielded Cable, 68 D-Type To 68 D-Type, 0.25 m	SH68-68-EPM Shielded Cable, 68 D-Type To 68 D-Type, 0.35 m	Kit, Cable Assembly, 2X 68-Pos Series D-Type, Type SH68-68-EPM, .5 m	Kit, Cable Assembly, 2X 68-Pos Series D-Type, Type SH68-68-EPM, 10 m	RC68-68 Ribbon Cable, 68 D-Type to 68 VHDCI Offset, 1 m	RC68-68 Ribbon Cable, 68 D-Type to 68 VHDCI Offset, .25 m
Part Number	199006-05	199006-0R25	199006-0R35	199006-0R5	199006-10	187252-01	187252-0R25
PXI-6704	—	—	—	—	—	—	—
PXI-6723	—	—	—	—	—	✓	✓
PXI-6733	✓	✓	✓	✓	✓	—	—
PXIe-6738	—	—	—	—	—	✓	✓
PXIe-6739	—	—	—	—	—	✓	✓

## Cables (continued)

Model	RC68-68 Ribbon Cable, 68 D-Type to 68 VHDCI Offset, .5 m	SHC68-68-A2, 68-Pin Male VHDCI to 68-Pin Female SCSI, 1 m Cable	SHC68-68-A2, 68-Pin Male VHDCI to 68-Pin Female SCSI, 2 m Cable	SHC68-68-A2, 68-Pin Male VHDCI to 68-Pin Female SCSI, 0.5 m Cable	SH68-C68-S, 68 Pin VHDCI To 68 Pin 0.05 Series D-Type 1 m	SH68-C68-S, 68 Pin VHDCI To 68 Pin 0.05 Series D-Type 0.5 m	SH68-C68-S, 68 Pin VHDCI To 68 Pin 0.05 Series D-Type SH68-C68-S 2 m
Part Number	187252-0R5	157599-01	157599-02	157599-0R5	186381-01	186381-0R5	186381-02
PXI-6704	—	—	—	—	—	—	—
PXI-6723	✓	—	—	—	✓	✓	✓
PXI-6733	—	—	—	—	—	—	—
PXIe-6738	✓	✓	✓	✓	—	—	—
PXIe-6739	✓	✓	✓	✓	—	—	—

## Digital I/O Modules

Category	Model	Part Number	Bus Connector	Digital I/O Logic Levels	Digital Input Voltage Range	Max Clock Rate	Bidirectional Digital Channels	Digital Input-Only Channels	Digital Output-Only Channels	Output Voltage Range	Signaling Type	Single-Ended Digital I/O Channel
30 V High-Channel DI	<a href="#">PXI-6511</a>	778967-01	PXI Hybrid	24 V	-30 V to 30 V	—	—	64	—	—	Single-Ended	—
30 V High-Channel DO	<a href="#">PXI-6512</a>	778969-01	PXI Hybrid	24 V	—	—	—	—	64	0 V to 30 V	Single-Ended	350 mA
30 V Sink/Source DI, Source DO	<a href="#">PXI-6514</a>	778965-01	PXI Hybrid	24 V	-30 V to 30 V	—	—	32	32	-30 V to 30 V	Single-Ended	350 mA
Highest-Channel Current Drive (475 mA), 32 DI, 32 DO	<a href="#">PXI-6515</a>	778964-01	PXI Hybrid	24 V	-30 V to 30 V	—	—	32	32	-30 V to 30 V	Single-Ended	475 mA
60 V Sink/Source DI/DO; Channel-Channel Isolated	<a href="#">PXI-6528</a>	778543-01	PXI Hybrid	60 V	-60 V to 60 V	—	—	24	24	-60 V to 60 V	Single-Ended	150 mA
Lowest Cost	<a href="#">PXIe-6509</a>	787358-01	PXI Express	5 V	0 V to 5 V	—	96	0	0	0 V to 5.5 V	Single-Ended	24 mA
Programmable Logic Level	<a href="#">PXIe-6535</a>	780695-0	PXI Express	2.5 V 3.3 V 5 V TTL	-1 V to 6 V	10 MHz	32	—	—	0 V to 5 V	Single-Ended	32 mA

## Digital I/O Accessories

### Connector Block

Connector Blocks	CB-50 I/O Connector Without Cable	CB-50LP Connector Block Without Cable	SCB-100A Noise-Rejecting, Shielded I/O Connector Block	CB-68LP Connector Block	SCB-68A Shielded Connector Block	TBX-68 Connector Block
Part Number	776164-90	777101-01	785024-01	777145-01	782536-01	777141-01
PXI-6511	✓	✓	✓	—	—	—
PXI-6512	✓	✓	✓	—	—	—
PXI-6514	✓	✓	✓	—	—	—
PXI-6515	✓	✓	✓	—	—	—
PXI-6528	✓	✓	✓	—	—	—
PXIe-6509	✓	✓	✓	—	—	—
PXIe-6535	—	—	—	✓	✓	✓

### Cables

Cables	Cable Assembly, 100 Pos .050 Series D-Type to 2X 50 Pos, Type R1005050, 1 m	Cable Assembly, 100 Pos .050 Series D-Type to 2X 50 Pos, Type R1005050, 2 m	Cable Assembly, 100 Pos .050 Series D-Type to 2X 50 Pos, Type R1005050, .5 m	Cable Assembly, 2 X 100-Pos .050 Series D-Type, Shielded, Flex Motion, Type SH 100 m-100 m Flex, 1 m	Cable Assembly, 2 X 100-Pos .050 Series D-Type, Shielded, Flex Motion, Type SH100 M-100 m Flex, 2 m (4150-0008)	C68-C68-D4 Unshielded Cable For High-Speed Digital I/O, 2X 68-Position VHDCI Offset, 1 m	SHC68-C68-D4 Shielded Single-Ended Cable, Lower DC Resistance, 3 m
Part Number	182762-01	182762-02	182762-0R5	185095-01	185095-02	195949-01	132625-03
PXI-6511	✓	✓	✓	✓	✓	—	—
PXI-6512	✓	✓	✓	✓	✓	—	—
PXI-6514	✓	✓	✓	✓	✓	—	—
PXI-6515	✓	✓	✓	✓	✓	—	—
PXI-6528	✓	✓	✓	✓	✓	—	—
PXIe-6509	✓	✓	✓	✓	✓	—	—
PXIe-6535	—	—	—	—	—	✓	✓

### Cables (continued)

Cables	SHC68-C68-D4 Shielded Single-Ended Cable, Low Leakage, 1 m	SHC68-C68-D4 Shielded Single-Ended Cable, 1 m	SHC68-C68-D4 Shielded Single-Ended Cable, 0.55 m	SHC68-C68-D4 Shielded Single-Ended Cable, 2 m
Part Number	152870-01	196275-01	781013-01	781293-01
PXI-6511	—	—	—	—
PXI-6512	—	—	—	—
PXI-6514	—	—	—	—
PXI-6515	—	—	—	—
PXI-6528	—	—	—	—
PXIe-6509	—	—	—	—
PXIe-6535	✓	✓	✓	✓

## Multifunction I/O Modules

Category	Model	Part Number	Analog Input Absolute Accuracy	Analog Input FIFO Buffer Size	Analog Input Resolution	Max Number of Differential Analog	Max Number of Single-Ended Analog	Max Sample Rate	Max Update Rate	Channels
High Channel Count	PXIe-6345	783631-01	1,520 $\mu$ V	4,095 Samples	16 Bits	40	80	500 kS/s	2.86 MS/s	Analog Output: 2 Bidirectional Digital: 24
	PXIe-6355	783632-01	1,520 $\mu$ V	4,095 Samples	16 Bits	40	80	1.25 MS/s	2.86 MS/s	Analog Output: 2 Bidirectional Digital: 24
	PXIe-6365	783633-01	1,520 $\mu$ V	4,095 Samples	16 Bits	72	144	2 MS/s	2.86 MS/s	Analog Output: 2 Bidirectional Digital: 24
	PXIe-6375	783634-01	1,660 $\mu$ V	4,095 Samples	16 Bits	104	208	3.86 MS/s	2.86 MS/s	Analog Output: 2 Bidirectional Digital: 24
General Purpose	PXIe-6363	781056-01	1,660 $\mu$ V	2,047 Samples	16 Bits	16	32	2 MS/s	2.86 MS/s	Analog Output: 4 Bidirectional Digital: 48
	PXIe-6361	781055-01	1,660 $\mu$ V	2,047 Samples	16 Bits	8	16	2 MS/s	2.86 MS/s	Analog Output: 2 Bidirectional Digital: 24
	PXIe-6341	781052-01	2,190 $\mu$ V	2,047 Samples	16 Bits	8	16	500 kS/s	900 kS/s	Analog Output: 2 Bidirectional Digital: 24
Simultaneous Sampling	PXIe-6366	781057-01	2,688 $\mu$ V	8,182 Samples	16 Bits	8	0	2 MS/s/ch	3.3 MS/s/ch	Analog Output: 2 Bidirectional Digital: 24
	PXIe-6368	781058-01	2,688 $\mu$ V	8,182 Samples	16 Bits	16	0	2 MS/s/ch	3.3 MS/s/ch	Analog Output: 4 Bidirectional Digital: 48
	PXIe-6376	781475-01	2,688 $\mu$ V	8,182 Samples	16 Bits	8	0	3.57 MS/s/ch	3.3 MS/s/ch	Analog Output: 2 Bidirectional Digital: 24
	PXIe-6378	781476-01	2,688 $\mu$ V	12,268 Samples	16 Bits	16	0	3.57 MS/s/ch	3.3 MS/s/ch	Analog Output: 4 Bidirectional Digital: 48
	PXIe-6356	781053-01	2,688 $\mu$ V	8,182 Samples	16 Bits	8	0	1.25 MS/s/ch	3.3 MS/s/ch	Analog Output: 2 Bidirectional Digital: 24
	PXIe-6358	781054-01	2,688 $\mu$ V	8,182 Samples	16 Bits	16	0	1.25 MS/s/ch	3.3 MS/s/ch	Analog Output: 4 Bidirectional Digital: 48
	PXIe-6124	780536-01	3,147 $\mu$ V	16382 Samples	16 Bits	4	0	4 MS/s/ch	4 MS/s/ch	Analog Output: 2 Bidirectional Digital: 24
	PXIe-6349	785808-01	3,225 $\mu$ V	4,095 Samples	16 Bits	32	0	500 kS/s/ch	900 kS/s	Analog Output: 2 Bidirectional Digital: 24
Highest-Rate Simultaneous Sampling	PXIe-6386	785926-01	1,769 $\mu$ V	8,182 Samples	16 Bits	8	0	14 MS/s/ch	3.3 MS/s/ch	Analog Output: 2 Bidirectional Digital: 24
	PXIe-6396	785927-01	1,769 $\mu$ V	8,182 Samples	18 Bits	8	0	14 MS/s/ch	3.3 MS/s/ch	Analog Output: 2 Bidirectional Digital: 24



## Multifunction I/O Accessories

### Cables

Cables	RC68-68 Ribbon Cable, 68 D-Type To 68 VHDCI Offset, 1 m	RC68-68 Ribbon Cable, 68 D-Type To 68 VHDCI Offset, .25 m	RC68-68 Ribbon Cable, 68 D-Type To 68 VHDCI Offset, .5 m	SHC68-68, Twisted Pair Cable With Basic Shielding, 1 m	SHC68-68, Twisted Pair Cable With Basic Shielding, 2 m
Part Number	187252-01	187252-0R25	187252-0R5	191945-01	191945-02
PXIe-6124	✓	✓	✓	✓	✓
PXIe-6341	✓	✓	✓	✓	✓
PXIe-6345	✓	✓	✓	✓	✓
PXIe-6349	✓	✓	✓	✓	✓
PXIe-6355	✓	✓	✓	✓	✓
PXIe-6356	✓	✓	✓	✓	✓
PXIe-6358	✓	✓	✓	✓	✓
PXIe-6361	✓	✓	✓	✓	✓
PXIe-6363	✓	✓	✓	✓	✓
PXIe-6365	✓	✓	✓	✓	✓
PXIe-6366	✓	✓	✓	✓	✓
PXIe-6368	✓	✓	✓	✓	✓
PXIe-6375	✓	✓	✓	✓	✓
PXIe-6376	✓	✓	✓	✓	✓
PXIe-6378	✓	✓	✓	✓	✓
PXIe-6386	✓	✓	✓	✓	✓
PXIe-6396	✓	✓	✓	✓	✓

## Cables (continued)

Cables	SHC68-68, Twisted Pair Cable With Basic Shielding, 0.5 m	SHC68-68-EPM Shielded Cable, 68-Position.050 Series D-Type to 68-Pos VHDCI Offset, 1 m	SHC68-68-EPM Shielded Cable, 68-Position.050 Series D-Type to 68-Pos VHDCI Offset, 2 m	SHC68-68-EPM Shielded Cable, 68-Position.050 Series D-Type to 68-Pos VHDCI Offset, 5 m	SHC68-68-EPM Shielded Cable, 68-Position.050 Series D-Type to 68-Pos VHDCI Offset, .5 m	SHC68-68-EPM Shielded Cable, 68-Position.050 Series D-Type to 68-Pos VHDCI Offset, 10 m
Part Number	191945-0R5	192061-01	192061-02	192061-05	192061-0R5	192061-10
PXIe-6124	✓	✓	✓	✓	✓	✓
PXIe-6341	✓	✓	✓	✓	✓	✓
PXIe-6345	✓	✓	✓	✓	✓	✓
PXIe-6349	—	—	—	—	—	—
PXIe-6355	✓	✓	✓	✓	✓	✓
PXIe-6356	✓	✓	✓	✓	✓	✓
PXIe-6358	✓	✓	✓	✓	✓	✓
PXIe-6361	✓	✓	✓	✓	✓	✓
PXIe-6363	✓	✓	✓	✓	✓	✓
PXIe-6365	✓	✓	✓	✓	✓	✓
PXIe-6366	✓	✓	✓	✓	✓	✓
PXIe-6368	✓	✓	✓	✓	✓	✓
PXIe-6375	✓	✓	✓	✓	✓	✓
PXIe-6376	✓	✓	✓	✓	✓	✓
PXIe-6378	✓	✓	✓	✓	✓	✓
PXIe-6386	✓	✓	✓	✓	✓	✓
PXIe-6396	✓	✓	✓	✓	✓	✓

## Connector Block

Connector Blocks	CB-68LP Connector Block	CB-68LPR I/O Connector Block	SCB-68A Shielded Connector Block	TBX-68 Connector Block	BNC-2111 Single-Ended, Shielded BNC Connector Block	BNC-2110 Noise-Rejecting, Shielded BNC Connector Block	BNC-2120 Shielded BNC Connector Block With Onboard Function Generator and Quadrature Encoder	BNC-2115 Noise Rejecting, Shielded BNC Connector Block For Extended I/O	BNC-2090A Rack-Mountable Accessory For 68-Pin Multifunction DAQ
Part Number	777145-01	777145-02	782536-01	777141-01	779347-01	777643-01	777960-01	777807-01	779556-01
PXIe-6124	✓	✓	✓	✓	—	✓	✓	—	✓
PXIe-6363	✓	✓	✓	✓	✓	✓	✓	—	✓
PXIe-6368	✓	✓	✓	✓	✓	✓	✓	—	✓
PXIe-6375	✓	✓	✓	✓	—	—	—	✓	—
PXIe-6376	✓	✓	✓	✓	—	✓	✓	—	✓
PXIe-6378	✓	✓	✓	✓	—	✓	✓	—	✓
PXIe-6386	✓	✓	✓	✓	—	✓	✓	—	✓
PXIe-6396	✓	✓	✓	✓	—	✓	✓	—	✓

# RF



As we push the boundaries of wireless communications, NI offers software defined radios, generators, analyzers, and transceivers for rapid prototyping and production test.



Recommended software (sold separately):

-  LabVIEW
-  RFmx
-  InstrumentStudio Professional

Additional resources for software development:

-  InstrumentStudio

## Vector Signal Transceivers

- Generate and acquire wide instantaneous bandwidth
- Ensure test coverage for new and legacy wireless standards
- Achieve better than -50 dB EVM performance for higher-order modulation schemes

### Key Features:

#### Test High Frequency and Wide Instantaneous Bandwidth

With frequency coverage from baseband to mmWave and up to 2 GHz instantaneous bandwidth, Vector Signal Transceivers (VSTs) are ideally suited for carrier aggregation, digital predistortion, and radar testing.

#### Perform Fast and Accurate EVM Measurements

Low phase noise, high linearity, and patented IQ calibration combine to achieve best-in-class EVM performance with higher-order modulation schemes.

#### Optimize RF Front-End Validation

Easy-to-use and customizable DPD algorithms and up to 2 GHz of instantaneous RF bandwidth translate to quick and easy DPD implementation in RFIC characterization.

## Vector Signal Transceiver Modules

Selection Guide	Model	Part Number	I/O Type	Module Width	Frequency Range	Instantaneous Bandwidth	EVM (5G NR 100 MHz, Loopback @ 5.5 GHz)	Tuning Time	P2P Streaming
High-Performance RF	PXIe-5842	789600-26211	RF In, RF Out, or Both	4 Slots	30 MHz–26.5 GHz	2 GHz	-58 dB	230 µs	Yes, up to 1 GHz
	PXIe-5842	789600-18211			30 MHz–18 GHz	2 GHz			Yes, up to 1 GHz
	PXIe-5842	789600-12211			30 MHz–12 GHz	2 GHz			Yes, up to 1 GHz
	PXIe-5842	789600-08211			30 MHz–8 GHz	2 GHz			Yes, up to 1 GHz
	PXIe-5842	789600-08111			30 MHz–8 GHz	1 GHz			Yes, up to 1 GHz
	PXIe-5842	789600-12111			30 MHz–12 GHz	1 GHz			Yes, up to 1 GHz
	PXIe-5842	789600-08511			30 MHz–8 GHz	500 MHz			Yes, up to 1 GHz
	PXIe-5842	789600-12511			30 MHz–12 GHz	500 MHz			Yes, up to 1 GHz
	PXIe-5842	788566-02	RF In and RF Out	6 Slots	200 MHz–23 GHz, 22.5 GHz–54 GHz	2 GHz			Yes, up to 1 GHz
Sub-6 GHz	PXIe-5841	786982-01	RF In and RF Out	2 Slots	9 kHz–6 GHz	1 GHz	-49 dB	380 µs	Yes, up to 1 GHz
	PXIe-5841	785832-01		3 Slots	9 kHz–6 GHz	1 GHz		175 µs	Yes, up to 1 GHz
mmWave, Built-In Switching	PXIe-5831	786856-01	RF In and RF Out	6 Slots	5 GHz–31.3 GHz, 37 GHz–44 GHz	1 GHz	-51 dB	500 µs	Yes, up to 1 GHz
IF	PXIe-5831	786853-01	RF In and RF Out	4 Slots	5 GHz–21 GHz	1 GHz		500 µs	Yes, up to 1 GHz
Baseband	PXIe-5820	783967-01	I/Q In and I/Q Out	2 Slots	DC–500 MHz	1 GHz	N/A	380 µs	Yes, up to 1 GHz



\* See the [RF Module Accessories](#)



Recommended software (sold separately):

-  LabVIEW
-  RFmx
-  InstrumentStudio Professional

Additional resources for software development:

- C/C++, .NET
-  LabWindows/CVI
-  InstrumentStudio

## Vector Network Analyzers

- Single-slot 26.5 GHz 2-port VNA with pass-through mode for VSG and VSA testing at VNA ports
- Combined VST+VNA simplifies large and small signal testing to one test insertion
- Vector Calibration Module for automated short-open-load-through (SOLT) calibration
- Software support with RFmx VNA and InstrumentStudio™ software

### Key Features:

**Single-Connection Modulation Analysis and S-Parameter Testing**  
 Pair the NI VNA with an NI VST to integrate both S-parameter and modulation measurements into a DUT test plan without complex switching setups.

**Simplified Calibration Process**  
 Simplify calibration using an electronic vector calibration module for short-open-load (SOL) and SOLT methodologies.

**Powerful Software**  
 RFmx is a set of interoperable measurement personalities together with waveform creation software that extends the capability of NI RF instrumentation for general-purpose, connectivity, cellular, and aerospace and defense test applications.

## Vector Network Analyzers Modules

Selection Guide	Model	Part Number	Frequency Range	Ports	Dynamic Range (Typical)	Maximum Source Power (Typical)	Corrected Directivity
High-Performance S-Parameter Capability	PXIe-5633	788182-26	50 MHz-26.5 GHz	2	125 dB (> 22 GHz to 26.5 GHz) 134 dB (> 18 GHz to 22 GHz) 137 dB (> 8 GHz to 18 GHz) 138 dB (> 6 GHz to 8 GHz) 146 dB (> 300 MHz to 6 GHz) 134 dB (100 MHz to 300 MHz)	+5 dBm (> 22 GHz to 26.5 GHz) +10 dBm (> 18 GHz to 22 GHz) +13 dBm (> 12 GHz to 18 GHz) +15 dBm (> 8 GHz to 12 GHz) +16 dBm (> 6 GHz to 8 GHz) +18 dBm (50 MHz to 6 GHz)	≥ 39 dB (> 20 GHz to 26.5 GHz) ≥ 40 dB (> 12 GHz to 20 GHz) ≥ 41 dB (> 8 GHz to 12 GHz) ≥ 42 dB (100 MHz to 8 GHz)
		788182-18	50 MHz-18 GHz	2	137 dB (> 8 GHz to 18 GHz) 138 dB (> 6 GHz to 8 GHz) 146 dB (> 300 MHz to 6 GHz) 134 dB (100 MHz to 300 MHz)	+13 dBm (> 12 GHz to 18 GHz) +15 dBm (> 8 GHz to 12 GHz) +16 dBm (> 6 GHz to 8 GHz) +18 dBm (50 MHz to 6 GHz)	≥ 40 dB (> 12 GHz to 20 GHz) ≥ 41 dB (> 8 GHz to 12 GHz) ≥ 42 dB (100 MHz to 8 GHz)
		788182-12	50 MHz-12 GHz	2	138 dB (> 6 GHz to 8 GHz) 146 dB (> 300 MHz to 6 GHz) 134 dB (100 MHz to 300 MHz)	+15 dBm (> 8 GHz to 12 GHz) +16 dBm (> 6 GHz to 8 GHz) +18 dBm (50 MHz to 6 GHz)	≥ 41 dB (> 8 GHz to 12 GHz) ≥ 42 dB (100 MHz to 8 GHz)
		788182-08	50 MHz-8 GHz	2	138 dB (> 6 GHz to 8 GHz) 146 dB (> 300 MHz to 6 GHz) 134 dB (100 MHz to 300 MHz)	+16 dBm (> 6 GHz to 8 GHz) +18 dBm (50 MHz to 6 GHz)	≥ 42 dB (100 MHz to 8 GHz)

## RF Module Accessories

### VST and VNA Accessories

Selection Guide	Cable Part Number	Length	Back-End Connection	Front-End Connection	Max Frequency	Description	Model Compatibility
High Performance, Temperature-Stable	136692-1000	1,000 mm	2.92 mm (Male)	2.92 mm (Male)	26.5 GHz	Phase stability over temperature for wideband and some VNA applications. Lower insertion loss.	PXIe-5842 PXIe-5841 PXIe-5831 PXIe-5633
	136692-0650	650 mm					
Temperature-Stable	136691-0870	870 mm	SMA (Male)	SMA (Male)	26.5 GHz	Phase stability over temperature for wideband and some VNA applications. Higher insertion loss.	PXIe-5842 PXIe-5841 PXIe-5831 PXIe-5633
	136691-0670	670 mm					
	136691-0400	400 mm					
High Performance, Phase-Stable for VNA Applications	137445-01	1,000 mm	3.5 mm (Male)	3.5 mm (Male)	26.5 GHz	Phase stable measurements (S-parameters). Best performance.	PXIe-5842 PXIe-5841 PXIe-5831 PXIe-5633
Phase-Stable for VNA Applications	137446-03	3,000 mm	3.5 mm (Male)	3.5 mm (Male)	26.5 GHz	Phase stable measurements (S-parameters). Higher flexibility.	PXIe-5842 PXIe-5841 PXIe-5831 PXIe-5633
	137446-01	1,000 mm					
Low Cost	137833-1000	1,000 mm	SMA (Male)	SMA (Male)	26.5 GHz	Suitable for most configurations needing 26 GHz. Low cost.	PXIe-5842 PXIe-5841 PXIe-5831 PXIe-5633
	137833-0600	600 mm					
	137833-0300	300 mm					
	137833-0150	150 mm					
Rated for mmWave Applications	138286-1000	1,000 mm	1.85 mm (Male)	1.85 mm (Male)	67 GHz	High-performance, suitable for mmWave applications.	PXIe-5842 PXIe-5831

### VNA Calibration Kits and Accessories

Selection Guide	Model	Part Number	Number of Ports	Frequency Coverage	Calibration Method
Electronic Vector Calibration Module	CAL-5501*	788189-01	2	50 MHz – 26.5 GHz	Short, Open, Load (SOL) and Short, Open, Load, Through (SOLT)

\*For Use With PXIe-5633 VNA Only



Recommended software (sold separately):

 LabVIEW

Additional resources for software development:

C/C++, Python, VHDL/Verilog, UHD/RfNoC

## Software Defined Radios

- 1 MHz to 7.2 GHz frequency ranges (tunable up to 8 GHz)
- Up to 1.6 GHz/channel of bandwidth
- Up to eight transmit and eight receive channels per radio
- Development tools such as LabVIEW, open-source UHD, GNU Radio, and MathWorks MATLAB<sup>®</sup> software

### Key Features:

#### Build Advanced Wireless Systems

Modern wireless systems require a new generation of software defined radios (SDRs) for prototyping and deployment. Systems need wider bandwidth, higher frequencies, and more advanced digital signal-processing architectures. Explore how the latest USRP (Universal Software Radio Peripheral) options offer enhanced performance to build your next advanced wireless prototype.

#### Prototype with Wider Bandwidth

Prototyping algorithms for applications such as radar research requires the need for wider bandwidths and more channels. At up to 1.6 GHz of bandwidth and eight transmit and receive channels, the NI Ettus USRP X440 achieves higher accuracy for direction-finding while maintaining phase coherency.

#### Use the Software of Your Choice

No matter your development tool preferences, you can be confident in USRP hardware, which is compatible with the broadest range of software workflows on the market. You can choose LabVIEW for a unified dataflow programming style, or use the open-source driver with support for C, C++, MathWorks MATLAB<sup>®</sup>, GNU Radio, and more.



## Software Defined Radio Modules

Selection Guide	NI Model	NI Ettus Model	Part Number	#TX	#RX	Frequency Range	Bandwidth
Stand-Alone, FPGA-Enabled, High Performance	<b>USRP X440</b>	USRP X440	788670-01	8	8	30 MHz—4 GHz	1.6 GHz
	<b>USRP X410</b>	USRP X410	787272-01	4	4	1 MHz—7.2 GHz	400 MHz
	—	<b>USRP N320</b>	786503-01	2	2	3 MHz—6 GHz	200 MHz
	—	<b>USRP N321</b>	786504-01				
	—	<b>USRP N310</b>	785067-01	4	4	10 MHz—6 GHz	100 MHz
	<b>USRP-2974</b>	N/A	785606-01	2	2	10 MHz—6 GHz	160 MHz
Host-Connected, FPGA-Enabled, High Performance	<b>USRP-2944</b>	USRP X310 + UBX	783149-01	2	2	30 MHz—6 GHz	160 MHz
	<b>USRP-2945</b>	USRP X310 + TwinRx	785263-01	0	4	10 MHz—6 GHz	80 MHz
	<b>USRP-2954</b>	USRP X310 + UBX + GPSDO	783153-01	2	2	30 MHz—6 GHz	160 MHz
	<b>USRP-2955</b>	USRP X310 + TwinRx + GPSDO	785264-01	0	4	10 MHz—6 GHz	80 MHz
Low Size, Weight, and Power (SWAP), Stand-Alone, Embedded	—	<b>USRP E310</b>	783773-01	2	2	70 MHz—6 GHz	56 MHz
		<b>USRP E313 (Rugged and Weatherproof)</b>	784583-01				
		<b>USRP E320 (Larger FPGA)</b>	786189-01				
Low SWAP, Low Cost, USB-Connected	—	<b>USRP B200mini-i</b>	785889-01	1	1	70 MHz—6 GHz	56 MHz
		<b>USRP B205mini-i (Larger FPGA)</b>	785888-01				
	<b>USRP-2900</b>	USRP B200	784039-01	1	1	70 MHz—6 GHz	56 MHz
	<b>USRP-2901</b>	USRP B210	784040-01	2	2	70 MHz—6 GHz	56 MHz

## Software Defined Radio Accessories

### USRP Power Cables

Part Description	EMI Suppression Ferrite, 13.05 mm	Power Cord for USRP RIO, Australia	Power Cord for USRP RIO, China	Power Cord for USRP RIO, Europe	Power Cord for USRP RIO, Japan	Power Cord for USRP RIO, Korea	Power Cord for USRP RIO, UK	Power Cord for USRP RIO, US	International Power Cords for USRP RIO
Part Number	784968-01	785023-03	785023-10	785023-04	785023-07	785023-09	785023-06	785023-01	783490-01
USRP X440	✓	✓	✓	✓	✓	✓	✓	✓	✓
USRP X410	✓	✓	✓	✓	✓	✓	✓	✓	✓
USRP 2955	✓	✓	✓	✓	✓	✓	✓	✓	—
USRP 2954	✓	✓	✓	✓	✓	✓	✓	✓	—
USRP 2945	✓	✓	✓	✓	✓	✓	✓	✓	—
USRP 2974	✓	✓	✓	✓	✓	✓	✓	✓	—
USRP N321	✓	✓	✓	✓	✓	✓	✓	✓	—
USRP N320	✓	✓	✓	✓	✓	✓	✓	✓	—
USRP N310	✓	✓	✓	✓	✓	✓	✓	✓	—

## RF Cables

Part Description	Kit for USRP systems includes Two SMA-M to SMA-M Cables (1 m) and Two SMA-F to SMA-M Attenuators (30 dB, 50 Ω, DC-6 GHz)	One SMA-M to SMA-M Cable, New Low-Loss Coax Good to 6 GHz, 1 m
Part Number	782781-01	783469-01
USRP X440	—	—
USRP X410	✓	✓
USRP 2955	✓	✓
USRP 2954	✓	✓
USRP 2945	✓	✓
USRP 2974	✓	✓
USRP N321	✓	✓
USRP N320	✓	✓
USRP N310	✓	✓
USRP 2900	✓	✓
USRP 2901	✓	✓
USRP B200mini/B205mini	✓	✓

## USRP X4XX Accessories

Part Description	USRP X4XX 19" Rack-Mount Accessory, 1U, 1 USRP X4XX Device, w/ Surrogate Extension	USRP X4XX 19" Rack-Mount Accessory, 1U, 2 USRP X4XX Devices, Shoulder to Shoulder	USRP X4XX Desktop Stack Accessory, Single USRP X4XX Device Fastened Buildup	USRP X4XX Fan Cartridge Accessory, Exhaust	USRP X4XX Fan Cartridge Accessory, Intake
Part Number	788149-01	788147-01	788148-01	788164-01	788165-01
USRP X440	✓	✓	✓	✓	✓
USRP X410	✓	✓	✓	✓	✓

## USRP X4XX Accessories (continued)

Part Description	Dual 100 Gigabit Ethernet PCIe Interface Kit for Ettus USRP X4XX	SHH19-H19-AUX Shielded Single-Ended Cable for AUX Digital I/O with Jackscrew, 2 m	PCIe Gen3 Interface Kit for Ettus USRP X4XX (Desktop)	QSFP28 to 4XSFP28 Breakout Cable, 1 m	QSFP28 Twinaxial Cable, 3 m	SCB-19 Noise-Rejecting, Shielded Auxiliary I/O Connector Block
Part Number	788216-01	152629-02	788264-01	788214-01	788215-03	782444-01
USRP X440	✓	✓	✓	✓	✓	✓
USRP X410	✓	—	✓	✓	✓	—

## USRP RIO Accessories

Part Description	PCIe-MXI Express Interface Kit for USRP RIO	PXIe-MXI Express Interface Kit for USRP RIO	SFP+ Cable, 1 m	GPIO Connection Kit for USRP RIO
Part Number	783487-01	783488-01	784076-01	783491-01
USRP 2974	✓	✓	✓	✓
USRP 2955	✓	✓	—	—
USRP 2954	✓	✓	—	—
USRP 2945	✓	✓	—	—
USRP 2944	✓	✓	—	—

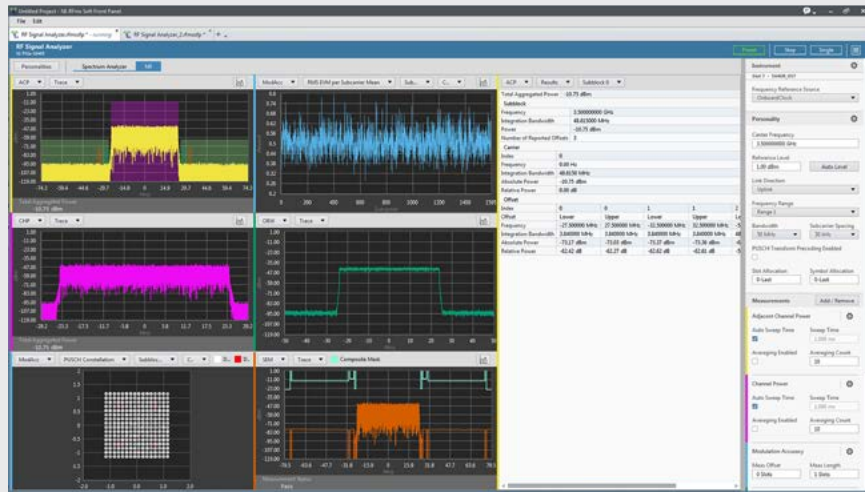

## NI RFmx

RFmx is a set of interoperable software applications that optimize NI RF instrumentation for general-purpose, cellular, connectivity, and aerospace/defense test applications. RFmx simplifies your signal generation and measurement experience.

### Key Features:

#### Standard-Compliant

Test multiple wireless standards for cellular, connectivity, and IoT signals. Select the personality of RFmx for your specific application and testing needs.

#### Quicker Start

Begin measurement out of the box with interactive soft front panels and, with waveform creation software, generate and modify unlocked waveforms.

#### Faster Execution

Complete testing quicker by taking advantage of innate high-speed measurement algorithms and composite measurement functionality.

# Instrument Control: GPIB, Serial

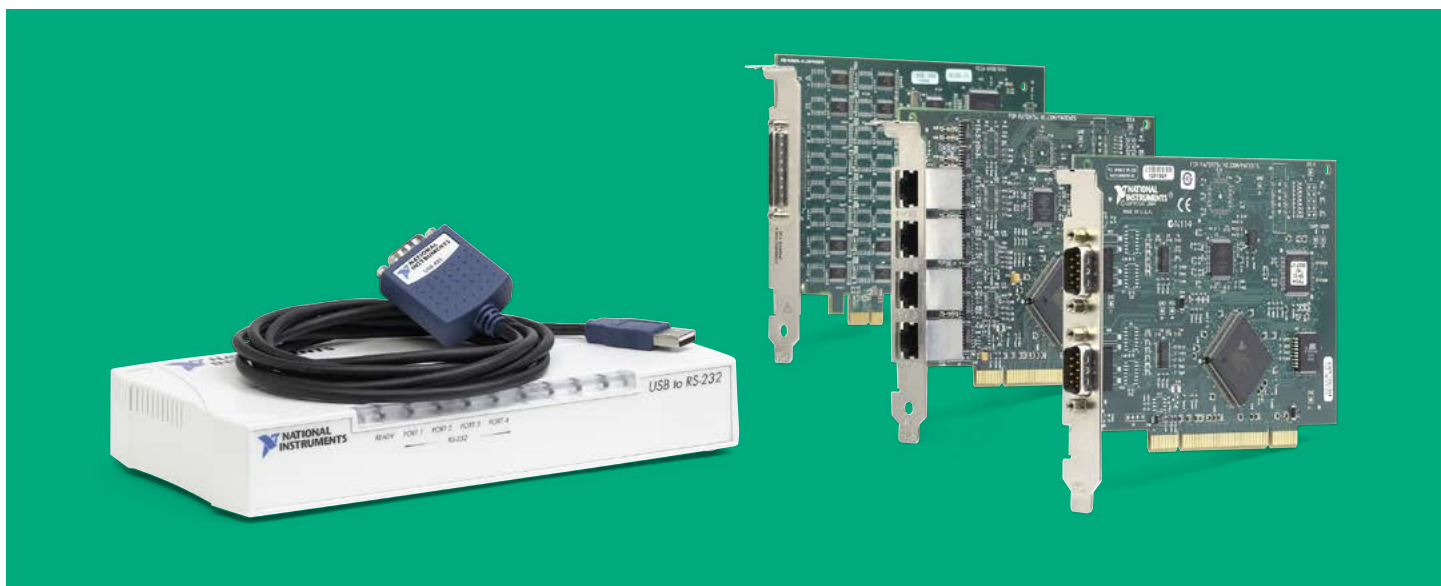

Recommended software (sold separately):  LabVIEW™

Too often, powerful box instruments are left on the shelf collecting dust because they communicate using outdated interfaces like serial and GPIB. NI instrument-control hardware can connect these instruments to your laptop or desktop using USB, Ethernet, or PCI Express. We also offer to Take advantage of thousands of ready-use instrument drivers that make it easy to control your instruments using LabVIEW.

Connection to Your Instrument	Connection to your Computer	Notes	Model Name
GPIB	Ethernet		<b>GPIB-ENET/1000</b>
GPIB	RS232		<b>GPIB-RS232</b>
GPIB	USB 2.0		<b>GPIB-USB-HS</b>
GPIB	USB 2.0	Onboard GPIB Analyzer	<b>GPIB-USB-HS+</b>
GPIB	PCI Express		<b>PCIe-GPIB</b>
GPIB	PCI Express	Onboard GPIB Analyzer	<b>PCIe-GPIB+</b>
RS232	PCI Express	2, 8, and 16 Channels	<b>PCIe-8430</b>
RS485, RS422	PCI Express	2, 8, and 16 Channels	<b>PCIe-8431</b>
RS232	PCI Express	2 Channels, Port-Port Isolation	<b>PCIe-8432</b>
RS485, RS422	PCI Express	2 Channels, Port-Port Isolation	<b>PCIe-8433</b>
RS232	USB 2.0	1, 2, and 4 Channels	<b>USB-232</b>
RS485, RS422	USB 2.0	1, 2, and 4 Channels	<b>USB-485</b>

## LabVIEW for Instrument Control

- 7000+ ready-to-run instrument drivers with examples and documentation
- Plug-and-play functionality for popular vendors like Tektronix, Keysight, Keithley, Rohde & Schwarz, and more
- Immediate start with open-and-run examples
- Flexible, scalable software platform to accomplish more with less time, effort, and budget

Visit our Instrument Driver Network ([NI.com/idnet](https://ni.com/idnet)) to download a driver to communicate with third-party instruments.

# NI Partner Network

The NI Partner Program offers domain, application, and overall test development expertise to help your team get ahead and stay ahead:

Innovate faster with proven scalable solutions

Reduce development time and cost through integration and consulting assistance

## Types of Partners



### Solution Partners

Experts in delivering products and solutions to solve your specific automated test or automated measurement application challenges.



### System Integrators

Specialists in integrating and deploying test and measurement systems, based on your specific requirements and their mature industry capabilities.



### Consultants

Experts in project services in areas such as software development, engineering, science, analytics, regulatory compliance, or other specialized skills to support complex systems.



### Distributors

Globally and regionally accessible, authorized distributors with local knowledge and an understanding of the available NI product portfolio, providing a one-stop option for configuring and sourcing your project needs.

Connect with our global community of trusted NI Partners ready to give your business a competitive edge. Find a partner or solution at [ni.com/findapartner](https://ni.com/findapartner).





# Services

NI offers a variety of services to ensure you can be successful throughout the lifecycle of your application. With global solution centers, NI engineers in more than 40 countries, and a vast network of more than 900 NI Partners, NI service programs help you mitigate risks, develop faster, and reduce costs to achieve your goals.

## Hardware Services

From the moment you unbox your hardware to deployment and maintenance, NI hardware services help you get started quickly and operate efficiently throughout the lifecycle of your test system.

Entitlement	Hardware Warranty	Standard	Premium	Description
Duration at Point of Sale	1 Year; Included	3 Years; Optional	3 Years; Optional	NI enhances warranty coverage with additional service benefits provided with a hardware service program.
Maximum Duration with Renewal	≤5 Years with Service Program	≤5 Years	≤5 Years	NI maintains high performance and availability of your hardware for up to 5 years with a hardware service program. For coverage beyond 5 years, NI provides lifecycle service options.
Extended Repair Coverage (3 or 5 years)	✓	✓	✓	NI restores your device's functionality and includes firmware updates and factory calibration.
System Configuration, Assembly, and Test	—	✓	✓	NI technicians assemble, install software on, and test your system per your custom configuration prior to shipment.
Advanced Replacement	—	—	✓	NI stocks replacement hardware that can be shipped immediately if a repair is needed.
System RMA	—	—	✓	NI accepts the delivery of fully assembled systems when performing repair services.
Technical Support	✓	✓	✓	NI provides access to support resources for your hardware.
Calibration Plan (Optional)	—	Standard	Expedited	NI performs the requested level of calibration at a specified calibration interval for the duration of the service program.

## Education Services

Education Services incorporate courses and certification programs from NI to help you proficiently develop applications, work with NI hardware, and more. You can apply your knowledge to reduce development time and increase productivity.



### Customer Education Courses

Attending on-location or in virtual classrooms and labs, gain knowledge on everything from fundamentals to advanced specifics and become familiar with NI hardware and software.



### Training Entitlements

You can gain unique and unlimited access to all NI training courses and certification programs using credits or a training membership.



### Certification Program

With certifications from associate developer to architect for LabVIEW and NI TestStand software, you can join the ranks of the thousands of engineers with NI professional certifications.

NI provides flexible options for purchasing training and certification. Whether you want to make an upfront investment or pay as you go, NI has offerings to meet a variety of budgetary needs.

#### Save money with a training membership

A training membership is a cost-effective way to take multiple instructor-led training courses. This program provides one year of unlimited access to instructor-led training and certification.

#### Buy credits now, schedule later

Purchase Education Services Credits now and redeem later for any training or certification offering. Education Services Credits expire after one year.

#### Secure a seat in a public course

View NI's global training calendar and secure a seat in an upcoming virtual or classroom instructor-led course.

#### Take advantage of on-demand learning

NI software licenses include one-year access to introductory on-demand learning content so you can onboard quickly. Additional on-demand courses are available for purchase.

#### Organize a private training event

NI offers private training events for teams of up to 12 students. Private training events can leverage standard NI training courses and include custom materials tailored to your needs.

## Technical Support Services

With the knowledge, experience, and responsiveness of NI applications engineers in more than 30 languages and 40 countries, NI has the technical support resources to ensure your success.

### Access Your NI Standard Technical Support:

#### Included with Software

Technical support included with your software subscription license

#### Included with NI Hardware Warranty

One year of standard technical support is included with all NI hardware through your hardware warranty



**Ihr Ansprechpartner /  
Your Partner:**

**dataTec AG**  
E-Mail: [info@datatec.eu](mailto:info@datatec.eu)  
**>>> [www.datatec.eu](http://www.datatec.eu)**

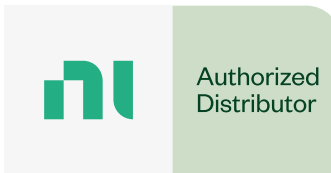

Mess- und Prüftechnik. Die Experten.

Neither Emerson, Emerson Automation Solutions, nor any of their affiliated entities assumes responsibility for the selection, use, or maintenance of any product. Responsibility for proper selection, use, and maintenance of any product remains solely with the purchaser and end user.

Engineer Ambitiously, LabVIEW, CVI, TestStand, DIAdem, FlexLogger, InstrumentStudio, CompactDAQ, CompactRIO, USRP, FlexRIO, and SourceAdapt are marks owned by one of the companies in the Test & Measurement business unit of Emerson Electric Co. Emerson and the Emerson logo are trademarks and service marks of Emerson Electric Co. Thunderbolt and the Thunderbolt logo are trademarks of Intel Corporation or its subsidiaries in the US and/or other countries. MathWorks®, MATLAB®, and Simulink® are registered trademarks of The MathWorks, Inc. The mark LabWindows is used under a license from Microsoft Corporation. Windows is a registered trademark of Microsoft Corporation in the United States and other countries. The registered trademark Linux® is used pursuant to a sublicense from LMI, the exclusive licensee of Linus Torvalds, owner of the mark on a worldwide basis. All other marks are the property of their respective owners. An NI Partner is a business entity independent from NI and has no agency or joint-venture relationship and does not form part of any business associations with NI.

The contents of this publication are presented for informational purposes only, and while every effort has been made to ensure their accuracy, they are not to be construed as warranties or guarantees, express or implied, regarding the products or services described herein or their use or applicability. All sales are governed by our terms and conditions, which are available upon request. We reserve the right to modify or improve the designs or specifications of such products at any time without notice.

NI  
11500 N Mopac Expwy  
Austin, TX 78759-3504

© 2024 National Instruments. All rights reserved.

Other product and company names listed are trademarks or trade names of their respective companies.

 [Linkedin.com/company/niglobal/](https://www.linkedin.com/company/niglobal/)

 [Twitter.com/NIglobal](https://twitter.com/NIglobal)

 [Youtube.com/@NIGlobalYoutube](https://www.youtube.com/@NIGlobalYoutube)

 [Instagram.com/niglobal/](https://www.instagram.com/niglobal/)

 [Facebook.com/NationalInstruments](https://www.facebook.com/NationalInstruments)