



Probing Solutions.
Made in Germany.

EN



Mess- und Prüftechnik. Die Experten.

**Ihr Ansprechpartner /
Your Partner:**

dataTec AG

E-Mail: info@datatec.eu

>>> www.datatec.eu



HORNET® Series

High Voltage Differential Probes
with Universal BNC Interface

$\pm 4000 \text{ V}$, $> 300 \text{ MHz}$

PRELIMINARY

Instruction Manual



Copyright © 2024 PMK - All rights reserved.

Manufacturer

PMK Mess- und Kommunikationstechnik GmbH
Königsteiner Str. 98
65812 Bad Soden, Germany

Tel: +49 (0) 6196 999 5000

Internet: www.pmk.de
E-Mail: sales@pmk.de

Warranty

PMK warrants this product for normal use and operation within specifications for a period of one year from date of shipment and will repair or replace any defective product which was not damaged by negligence, misuse, improper installation, accident or unauthorized repair or modification by the buyer. This warranty covers defects in materials and workmanship only and does not cover wear and tear. PMK disclaims any other implied warranties of merchantability or fitness for a particular purpose. PMK will not be liable for any indirect, special, incidental, or consequential damages (including damages for loss of profits, loss of business, loss of use or data, interruption of business and the like), even if PMK has been advised of the possibility of such damages arising from any defect or error in this manual or product.

Declaration of Conformity



PMK declares the conformity of this product with the actual required safety standards in accordance with the Low Voltage Directive (LVD) 2014/35/EU:

The basis on which conformity is being declared:

EN IEC 61326-1:2021	Electrical equipment for measurement, control and laboratory use – EMC requirements - Part 1: General requirements
EN IEC 61000-4-2:2008	Electromagnetic compatibility (EMC) –Part 4-2: Testing and measurement techniques –Electrostatic discharge immunity test
EN IEC 61010-1:2020	Safety requirements for electrical equipment for measurement, control and laboratory use – part 1: General safety requirements for electrical equipment for measurement, control, and laboratory use.

WEEE/ RoHS Directives



This electronic product is classified within the WEEE/ RoHS category list as monitoring and control equipment (category 9) and is compliant to the following EC Directives.

WEEE Directive 2012/19/EU	Waste Electrical and Electronic Equipment
RoHS Directive 2011/65/EU	Restriction of the use of certain Hazardous Substances in Electrical and Electronic Equipment

Your help and efforts are required to protect and keep clean our environment. Therefore, return this electronic product at the end of its life either to our Service Department or take care of separate WEEE collection and professional WEEE treatment yourself. Do not dispose as unsorted municipal waste.

Table of Contents

Manufacturer.....	2
Warranty.....	2
Declaration of Conformity	2
WEEE/ RoHS Directives	2
IEC Pollution Degrees.....	4
IEC Safety Symbols.....	4
Safety and Handling Information	5
About HORNET® Probe Series.....	6
Factory Calibration	6
Specifications.....	7
Electrical Specifications	7
Mechanical Specifications	8
Environmental Specifications	8
Dimensions.....	8
Probe's power supply pin assignment.....	8
Typical Voltage Derating	9
Typical Input Impedance	9
Maximum Input Voltage, Example 4000V Model, 1000:1 Range.....	10
Maximum Input Voltage, Example 4000V Model, 100:1 Range.....	10
Cleaning	10
General Information	11
Handling Information	11
Probe Head Indicator Layout.....	12
User Default	12
Keylock	12
Global Offset	13
Setup Menu.....	13
Reset Factory Default	14
EMC Noise Suppression Kit.....	14
Scope of Delivery	14
Ordering Information.....	15

IEC Pollution Degrees

Definitions and Examples:

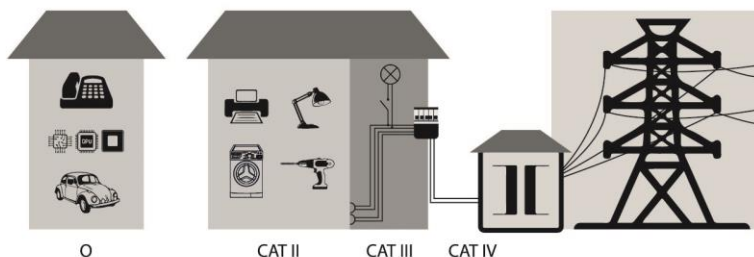

Overview of measurement categories according to IEC 61010-01

O = No Measurement Category (Other circuits that are not directly connected to mains)

- Pollution Degree 1** No POLLUTION or only dry, nonconductive POLLUTION. NOTE: The POLLUTION has no influence.
- Pollution Degree 2** Only- nonconductive POLLUTION. Occasionally, however, a temporary conductivity caused by condensation must be accepted.
- Pollution Degree 3** Conductive POLLUTION occurs or dry, non-conductive POLLUTION occurs which becomes conductive due to condensation which is to be expected.

IEC Safety Symbols

The following symbols may appear on the product or in this instruction manual:



Caution, risk of danger. Refer to manual.



Caution, risk of electric shock.



Earth (ground) TERMINAL.

Safety and Handling Information

The overall safety of any measurement setup incorporating this probe is the responsibility of the user. To prevent electrical accidents, read the safety instructions carefully. Observe the five safety rules of the German standard series EN 50110-1.



Use the probe head's keyboard only when the circuit under test is de-energized. Use non-handheld and in test setups with safety environment only.

This probe is not for hand-held use. Install the probe in a safety protected test environment and make all required configurations before starting the measurements.



Prevent personal injury, fire and product damage.

To avoid personal injury and to prevent fire or damage to this product or products connected to it, review and comply with the following safety precautions. Be aware that if you use this probe assembly in a manner not specified the protection this product provides may be impaired. Only qualified personnel should use this probe assembly.



Use only grounded instruments.

Do not connect the probe's BNC ground to a potential other than earth ground. Always make sure the probe and the measurement instrument are grounded properly.



Connect and disconnect properly.

Connect the probe output to the measurement instrument before connecting the probe's inputs to the circuit under test.

Disconnect the probe's inputs from the de-energized circuit under test before disconnecting the probe from the measurement instrument.



Observe probe and probe accessory ratings.

Do not apply any electrical potential to the probe input which exceeds the maximum ratings of the probe, or the accessories connected to it. In case of a combination, always the lower rating / measurement category applies to both probe and accessories connected to it.



Keep away from hazardous live circuits.

Avoid open circuitry. Do not touch connections or components when power is present.



Do not operate with suspected failures. Check the coaxial probe cable for damages to make sure it has no failures. The cable has no wear indicator.

If the contrasting color of the wear indicator of the 4mm input cable has become visible, then stop using the probe and contact your local PMK service center.

Refer to qualified service personnel.

Indoor use only.

Do not operate in wet or damp environment. Keep the product dry and clean.

Do not operate the product in an explosive atmosphere.



The max. input voltage decreases as the frequency of the applied Sine signal increases (see Voltage Derating curve).

See the relevant section of this manual for further information on maximum input voltage, voltage derating and definitions of relevant IEC Measurement Categories (CAT).

About HORNET® Probe Series

The state-of-the-art high voltage differential probe series HORNET® establishes itself as the best-in-class solution for the growing demands of wide bandgap power electronics design, e.g. double pulse testing of high-speed high-voltage switching devices of SiC technology, and IGBTs, thyristors, fast-switching HV diodes, and more.

HORNET®'s $\pm 4000\text{V}$ differential and common mode voltage capability provide engineers with the flexibility to tackle the most challenging high voltage applications in power electronics design.

With a bandwidth exceeding 300MHz, HORNET® ensures accurate and reliable measurements for fast-switching wide bandgap, SiC, power electronics, making it an essential tool for engineers working on advanced designs having a protected test environment.

HORNET® is engineered to deliver precise and consistent results, allowing designers to optimize the efficiency and performance of their power electronic systems with confidence.

The probe is designed with advanced safety features to safeguard both users and the equipment during high voltage measurements. Anyhow, HORNET® series probes are not for handheld use and for integration into full-automated or manual test stations for high-voltage safety reasons. HORNET® is therefore used as a voltage-measuring component (permanently attached device) of a test system.

The HORNET® series probes have a universal BNC output connector and are compatible with any oscilloscope in the lab with 50 Ω input impedance, or 1M Ω input impedance and a 50 Ω feed-through termination.

All HORNET® series models require a power supply, which is not included in the scope of delivery, and has to be ordered separately. Review the *Ordering Information* at the end of this document for more details. The interface box is powered by the required PMK power supply. The referring power supplies all have remote control capabilities and therefore a USB interface and optional additional LAN interface. As an alternative for most flexible use, the 1 channel battery pack power supply AP-01 provides >8h of portable and isolated operation but has no software remote control.

HORNET® series has the capability to be controlled from either remote control or the controls located on the interface box.

- For remote control PMK offers the software "PMK Probe Control" with graphical user interface, which is shipped with any PS2 and PS3 power supply, and is available for download at: <http://www.pmk.de/en/products/probecontrol>
- In addition, the Python package "PMK-probes" is available as a programming interface for controlling PMK's active probes. Installation instructions, examples and documentation is available at: <https://pmk-probes.readthedocs.io/en/latest/>

Measurement Principle

The high voltage differential probe series HORNET® consists of two balanced precision attenuators, which are differentially matched. The attenuators scale the input voltage before passing into the differential amplifier. The output of the differential is fed over a driver stage to the 50 Ω input of a measuring device.

Factory Calibration

All models are shipped with factory calibration certificates. Annual factory re-calibration is recommended. ISO17025 calibration upon delivery or as re-calibration is possible on request.

Specifications

Read the Instruction Manual before first use and keep it for future reference. A digital copy of the latest Instruction Manual revision can be downloaded at www.pmk.de.

Do not exceed the specifications. Allow the probe to warm up for 20 minutes. This probe comes with 1 year warranty. Each specification is determined at +23 °C ambient temperature. This probe series is not for hand-held use, and not rated for CAT II, III or IV.

Electrical Specifications

Electrical Specifications¹ that are not marked with (*) as guaranteed are typical.

Article number	HORNET4kV	
Attenuation* ($\leq \pm 1\%$ guaranteed)	1000:1, 500:1, 200:1, 100:1	
Bandwidth* (-3 dB)	$\geq 300\text{MHz}$	
Small Signal (guaranteed)		
Rise time (10 % - 90 %)	1000:1, 500:1: 1.0 ns	
Large Signal	200:1, 100:1: 1.1 ns	
Maximum Rated Input Voltages²		
No Measurement Category	4000 V rms + 4000 V transient overvoltage	
CAT Rating	not applicable	
Pollution Degree	2	
Maximum Differential Input Voltage (DC + AC peak)	1000:1 $\pm 4000\text{ V}$ 500:1 $\pm 2000\text{ V}$ 200:1 $\pm 800\text{ V}$ 100:1 $\pm 400\text{ V}$	
Common Mode Voltage	$\pm 4000\text{ V peak (2800 V RMS)}$	
DC Gain Accuracy ³	$\pm 1.5\%$ (preliminary)	
Propagation Delay ($\pm 0.5\text{ ns}$)	12 ns	
Noise (AC RMS) (Referred to Input)		
30 MHz bandwidth	400V: 0.11 V, 800V: 0.11 V 2000V: 0.13 V, 4000V: 0.14 V	
Full bandwidth	400V: 6.2 V, 800V: 5.2 V 2000V: 1.2 V, 4000V: 0.63 V	
Input Impedance⁴		
Each Input to Ground	10 M Ω $< 5\text{ pF}$	
Differential Input Impedance	20 M Ω $< 2.5\text{ pF}$	
Common Mode Rejection Ratio (CMRR) *preliminary*	DC: > 70 dB 100 kHz: > 60 dB 1 MHz: > 60 dB 3.2 MHz: > 60 dB	10 MHz: > 50 dB 50 MHz: > 40 dB 100 MHz: > 30 dB 300 MHz: > 25 dB

The use of a digital filter with BW=400MHz is recommended.



The electrical specifications are valid for use in a controlled environment, like a semi-conductor tester or test setup with protective cover.

Notes:

¹ Determined when using a PMK power supply PS-02 at +23°C ambient temperature.

² The rating is based on basic insulation in a controlled environment in accordance with IEC 61010-1. Also observe the definitions in the probe series' s instruction manual.

³ Input voltage $> 25\%$

⁴ Including input leads, cables in parallel, measurement frequency 1MHz.

Mechanical Specifications

Parameter	Specification
Weight (Probe only)	370 g
Length	2 m
Probe Input ¹	4mm safety banana (male)
Output Connector	BNC (male)

Notes:

¹ Different accessories for connectivity are available. Please review the section “Ordering Information”.

Environmental Specifications

Parameter		Specification
Temperature Range	Operating	0 °C to +50 °C
	Non-Operating	-40 °C to +71 °C
Maximum Relative Humidity	Operating	80 % relative humidity for temperatures up to +31 °C, decreasing linearly to 40 % at +50 °C
	Non-Operating	95 % relative humidity for temperatures up to +40 °C
Altitude	Operating	up to 2000 m
	Non-Operating	up to 15000 m

Dimensions

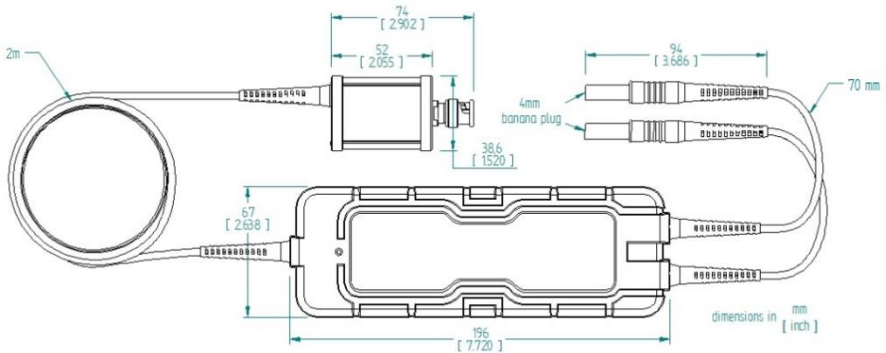

Probe’s power supply pin assignment

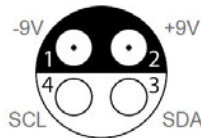

Probe’s power supply pin assignment “cable view”



Observe the probe’s power supply pin assignment.

Typical Voltage Derating



Note that the maximum input voltage rating of the probe decreases as the frequency of the applied signal increases.

Typical Voltage Derating – HORNET4kV
No Measurement Category

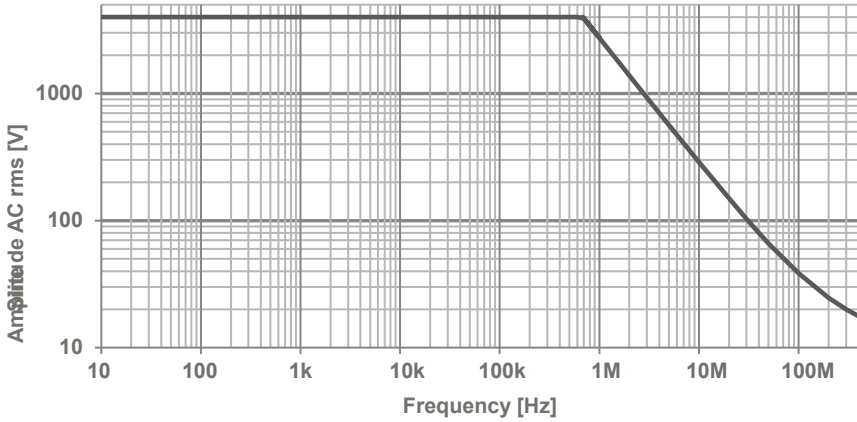

Typical Input Impedance



The input impedance of the probe decreases as the frequency of the applied signal increases.

Typical Differential Input Impedance – HORNET4kV

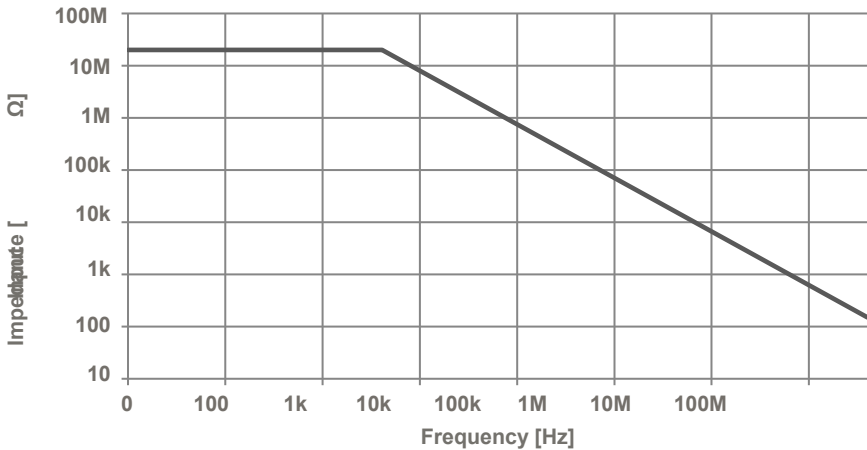

Maximum Input Voltage, Example 4000V Model, 1000:1 Range

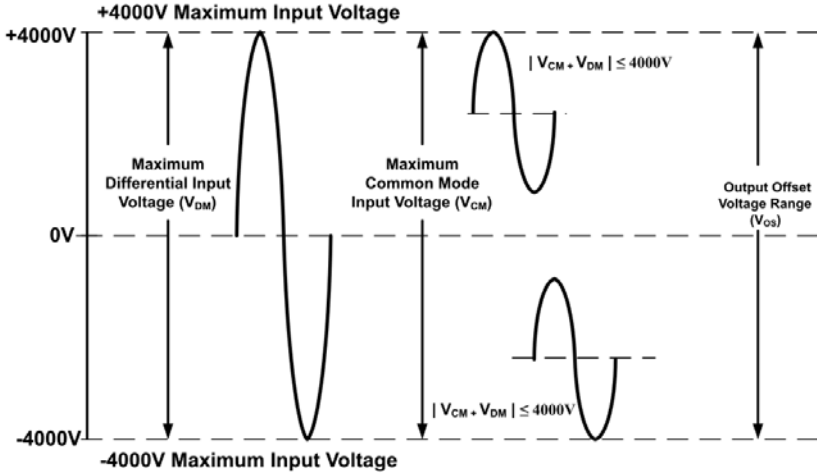

Maximum Input Voltage, Example 4000V Model, 100:1 Range

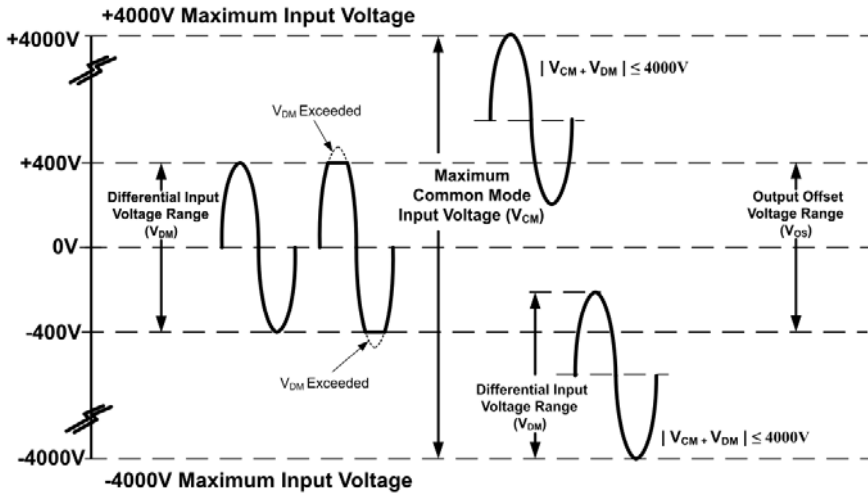

Cleaning

To clean the exterior of the probe, use a soft cloth moistened with either distilled water or isopropyl alcohol. Before use allow the probe to dry completely.

General Information

Read the "Safety and Handling Information" in this manual before first use.

When using HORNET® series non-hand-held probes install it in a safety environment only, e.g. a tester application. Probe configurations via remote control are recommended.



Download "PMK Probe Control" PC software or Python package from www.pmk.de

Make all required probe settings before the measurement starts. To prevent electrical accidents, read the safety instructions and this entire manual carefully, and observe the five safety rules of the German standard EN 50110-1.



This is not a hand-held probe. Make sure the probe is installed in a safety environment. and configured completely prior to its operation.

Handling Information

Adjust the input coupling of the measuring instrument to 50Ω before connecting the probe to it. After connecting the power supply, you hear a short triplet of signals from the buzzer and the LEDs on the probe head will blink.

Connect first the BNC output to the oscilloscope, then connect the probe inputs to the deenergized circuit under test.

Best practice: Drill the input leads twice for best CMRR but acceptable bandwidth degradation.



For use in environments with high levels of electro-magnetic interference (EMI), the noise suppression kit is recommended, and to be installed on the signal cable near the interface box.

Adjust the attenuation and offset correction if needed. After all settings are made, the probe is ready to be used as component of the measurement system.



For removing the probe's input from the DUT, or for changing the configuration via the knobs at the probe head, make sure the circuit under test is de-energized.

Probe Head Indicator Layout



Use the probe head's control buttons only if the circuit under test is de-energized. Remote control is recommended.

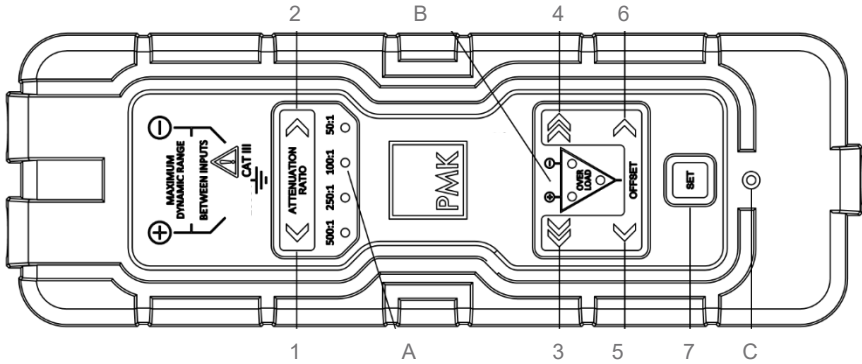

Buttons (Controlled via the Remote Probe Control Interface)

- | | |
|-----------------------------------|-----------------------------------|
| 1 Higher attenuation | 2 Lower attenuation |
| 3 Negative active Offset coarse * | 4 Positive active Offset coarse * |
| 5 Negative active Offset fine * | 6 Positive active Offset fine * |
| 3+5 Negative active Offset XL * | 4+6 Positive active Offset XL * |
| | 7 Set Button |

* Change the factory presets, 250mV, 4V, 400V via the remote control software "PMK Probe Control".

LED Lights A - C

- A Attenuation Indicators (varying with model)
- B Overvoltage Indicators: Input Channels, Output
- C Colored Indicator of the Measuring Channel

User Default

The User Default settings of the HORNET® series probe are loaded automatically when the probe is powered up. They are saved in real-time, with no need to actively save or recall at any time.

Keylock

If no key is pressed 10 seconds after opening the menu the keypad will be locked. Press the "Set" button again to release it.



Use the probe head's control buttons only if the circuit under test is de-energized. Remote control is recommended.

Global Offset

By pressing "Set" you can switch between the set global offset position and zero. While in setup menu, this function is not available. Also with set "Hold Overload" an occurring overload event must be cleared before switching offset zero position is available.



Use the probe head's control buttons only if the circuit under test is de-energized. Remote control is recommended.

Setup Menu

Access the setup menu by holding the "Set" button for 5s. The Overvoltage-indicator LED of the output blinks green as confirmation.

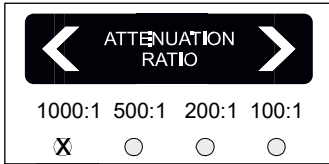

The setup menu starts with the unlit/off LED 1000:1, the Channel Identification Color menu, menu point I.

The selected menu item is indicated by the attenuation LEDs.

Change the menu selection using buttons "1" and "2". Use the Buttons "5" and "6" configure the settings in the menu. Press "7", the SET button, to exit the menu.



Use the probe head's control buttons only if the circuit under test is de-energized. Remote control is recommended.

In the following LEDs are marked as x = unlit/off and o = lit/on.

Channel Identification Color (x o o o) - Menu point I

For channel identification the following colors (modes) are available:
unlit, white, yellow, cyan, pink, blue, green, red.

Overload Buzzer (o x o o) - Menu point II

In case of detected overvoltage at input or output channel, the Overload Buzzer gives an audible signal and can be turned on- and off with Button "5". Additionally, the Hold-Overload Buzzer can be activated with Button "6". In case of detected overvoltage, the "Set" Button must be pressed to confirm and carry on.

Key buzzer (o o x o) - Menu point III

Activate the Key Buzzer, giving audible feedback when any Button on the keypad is pressed.

Offset synchronization (o o o x) - Menu point IV

Turn offset synchronization on and off.

Offset-Zero(o o o x) - Menu points V - VIII

Adjust offset-zero per attenuation mode.

Menu point	Model:	HORNET4kV	LEDs
V		1000:1	o x x x
VI		500:1	x o x x
VII		200:1	x x o x
VIII		100:1	x x x o

Reset Factory Default

By pressing both buttons "1+2" together while in setup menu, the probe resets to factory settings. Hold both buttons for 5s and wait until you hear a differing signal.



Use the probe head's control buttons only if the circuit under test is de-energized. Remote control is recommended.

EMC Noise Suppression Kit

For use of PMK's high-voltage differential probes in environments with high levels of interference, like in double-pulse tester applications for analysis of fast switching power devices, the EMC noise suppression kit 891-102-EMC is recommended. Recommended installation is on the signal cable near the interface box.



Please note that signal lines must never be laid parallel to pulsed lines. This also includes AC fields. Ensure that there is sufficient distance. The ferrites can be used in any order or individually.

Scope of Delivery

A PMK power supply is required for all models. See chapter "Ordering Information" to review the selection.

Probe HORNET® series
Factory calibration certificate
Instruction manual

891-102-EMC

EMC Noise Suppression Kit for use in environments with high levels of interference, like in DP tester applications (3x ferrites & opening key)

890-520-000

Power Supply Cable (0.5 m), 30VAC / 60V DC
(1.5m cable available as option)

890-880-103

Pair of Probe Tip Adaptors 4mm to 0.8mm (2x black)

2x 890-808-105

2-Footer

890-880-102

Set of 4 Spring Tips (fine)

890-880-101

Set of 10 Contact Pins 0.64mm

890-880-110

Pair of Spade Terminals, narrow (black / red), 30V AC / 60V DC

890-880-107

Pair of Spade Terminals, wide (black, red), 30V AC / 60V DC



Ordering Information

Step 1: Select the Probe

HORNET4kV High voltage differential probe, 4000V, >300MHz, with four selectable dividing ranges, 1000:1, 500:1, 200:1, 100:1



Step 2: Select Additional Accessories

Note, that any additional accessory degrades the probe's performance. Always observe the lowest Maximum Input Voltage. Do not use any other accessories than recommended by PMK.

016-397-049

Carrying Case with Foam Inlay (black)



890-880-106

Pair of Mini Spring Tip Probes 4 mm (black, red), 600V CAT II



890-808-105

2-Footer



4mm-SMA-M

4mm safety banana socket to SMA plug adapter, for high-frequency voltage measurements, 500V DC + AC pk, 1000V peak pulse



4mm-SMA-F

4mm safety banana socket to SMA socket adapter, for high-frequency voltage measurements, 500V DC + AC pk, 1000V peak pulse



4mm-MMCX-M

4mm safety banana socket to MMCX plug adapter, for high-frequency voltage measurements, 250V DC + AC pk, 500V peak pulse



4mm-MMCX-F

4mm safety banana socket to MMCX socket adapter, for high-frequency voltage measurements, 250V DC + AC pk, 500V peak pulse



4mm-BNC-F

4mm safety banana socket to BNC socket adapter, for high-frequency voltage measurements, 750V DC + AC pk, 1500V peak pulse



4mm-WSQ-5.08

4mm safety banana socket to square pin adapter, 5.08mm, for high-frequency voltage measurements, 750V DC + AC pk, 1500V peak pulse



890-880-115

Pair of Clamps, Hook (black & red), 1000V CAT II



890-880-114

Pair of Clamps, Jaws (black & red), 1000V CAT III



Continues on next page...

890-880-113

Pair of Clamps, Rotating Grip Jaw (black & red)
1000V CAT II



890-880-108

Pair of Safety Alligator Clips, big (black & red), 1000V CAT III



890-880-111

Pair of Safety Alligator Clips, small (black & red), 600V CAT III



890-880-112

5x Pair of Rail Clip Connectors 4 mm (black, red), 600V CATIII



890-880-116

4 mm Coupler f-f (red), 30VAC / 60V DC



890-880-109

Pair of Magnet Connectors 4 mm (black/red), 30VAC / 60V DC



D010031

50Ω BNC feed-through for 1MΩ input oscilloscopes. >500MHz



890-880-103

Pair of Probe Tip Adaptors 4mm to 0.8mm (2x black) – spare part



890-880-102

Set of 4 Spring Tips (fine) – spare part



890-880-101

Set of 10 Contact Pins 0.64mm – spare part



890-880-110

Pair of Spade Terminals, narrow (black / red), 30V AC / 60V DC – spare part



890-880-107

Pair of Spade Terminals, wide (black, red), 30V AC / 60V DC– spare part



Step 3: Select Power Supply

A PMK power supply is required, and available separately.

889-09V-PS2	PS-02, 2ch power supply, with USB interface for remote control, for 100 -240V AC / 50 - 60Hz mains *
889-09V-PS2-L	PS-02-L, 2ch power supply, with LAN and USB interface for remote control, for 100 -240V AC / 50 - 60Hz mains *
889-09V-PS3	PS-03, 4ch power supply, with USB interface for remote control, for 100 -240V AC / 50 - 60Hz mains *
889-09V-PS3-L	PS-03-L, 4ch power supply, with LAN and USB interface for remote control, for 100 -240V AC / 50 - 60Hz mains *
890-520-915	Power Supply Cable, 1.5 m (0.5m cable included I scope of delivery)

Observe Connector Pin-Out for PMK power supply cables



The power supply pin assignment is different from other power supplies. Use only original PMK power supplies with PMK probes.

Step 4: Select Positioning System

893-350-010

3D positioner with steel base, 200 mm span width, twin holder, ideal for reliable positioning when the probe's inputs is equipped with spring loaded tips



893-350-015

3D positioner with steel base, 200 mm span width and probe holder



893-350-014

3D positioner with steel base, arm with 200 mm span width and probe head holder, arm with 130 mm span width and twin holder, ideal for reliable positioning of a BumbleBee® or HORNET® series probe when the probe inputs are equipped with spring loaded tips



893-350-013

BumbleBee® or HORNET® series probe head holder – spare part, for use with PMK's SKID positioning system for PCBs and probes



890-880-104

Twin holder M6 – spare part, for use with PMK's SKID positioning system for PCBs and probes



Step 5: Select Accredited Calibration

KAL-DAKKS-HORNET4kV ISO 17025 (re-)calibration



Mess- und Prüftechnik. Die Experten.

**Ihr Ansprechpartner /
Your Partner:**

dataTec AG

E-Mail: info@datatec.eu

>>> www.datatec.eu

Copyright © 2024 PMK - All rights reserved.

Information in this publication supersedes that in all previously published material.
Specifications are subject to change without notice.

Informationen in dieser Anleitung ersetzen die in allen bisher veröffentlichten Dokumenten.
Änderungen der Spezifikationen vorbehalten.