

dataTec

Ihr Ansprechpartner /
Your Partner:

dataTec AG
E-Mail: info@datatec.eu
>>> www.datatec.eu



Authorized
Distributor

Mess- und Prüftechnik. Die Experten.

NI PXI Product Catalog

Test



Automate



Measure

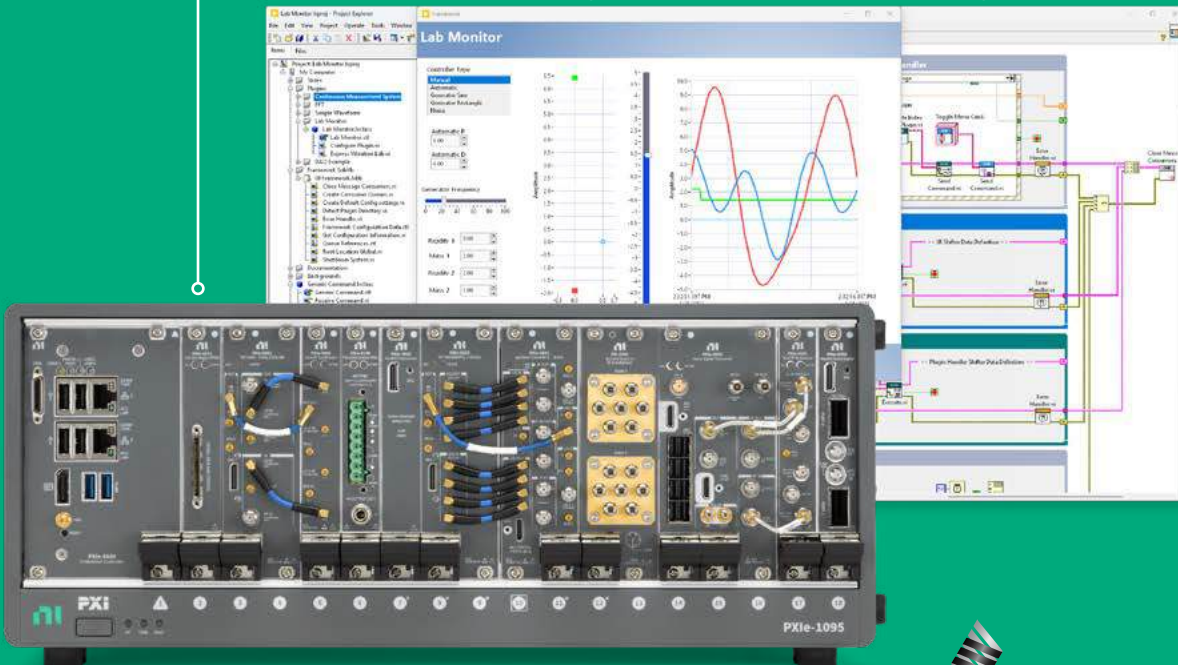

October 2024



Contents

- 03** What Makes NI Different for Test and Measurement
 - 04 Find NI Anywhere There Is Test
 - 04 Companies and Engineers Seeing Success with NI Today
 - 05 NI Hardware Is Modular
- 07** Why Choose LabVIEW for Test
 - 07 Program Like You Think
 - 08 LabVIEW Connects to Everything in Your Test System
 - 08 Build a Custom User Interface in Minutes
 - 09 Integrate Code from Other Programming Languages
- 10** Get Access to All the Software You Need in the LabVIEW+ Suite
- 12** NI Test Software Overview
 - 14 NI LabVIEW
 - 15 NI G Web Development Software
 - 16 NI TestStand
 - 17 NI DIAdem
 - 18 NI FlexLogger™ Software
 - 19 NI InstrumentStudio™ Software
- 20** PXI Systems
 - 20 Why PXI for Automated Test?
 - 21 How to Build a PXI Test and Measurement System
 - 22 PXI Chassis
 - 27 PXI Controllers
 - 31 PXI Remote Controllers and System Expansion
- 34** PXI Instrument Overview
 - 36 PXI Oscilloscopes
 - 41 PXI Digital Multimeters
 - 43 PXI Waveform Generators
 - 45 PXI Counter/Timers
 - 47 PXI Power Supplies
 - 49 PXI Switches
 - 50 NI Switch Executive Software
 - 59 PXI Source Measure Units
 - 63 PXI LCR Meters and SMUs
 - 65 PXI Digital Pattern Instruments
 - 66 NI Digital Pattern Editor Application Software
 - 67 PXI Digital Waveform Instruments
 - 70 PXI Electronic Loads
 - 72 PXI High-Speed Serial
 - 75 PXI Timing and Synchronization
- 77 PXI Sound and Vibration Modules
- 80 PXI Signal-Conditioning Modules
- 85 PXI Reconfigurable I/O Module (FPGA)
- 88 PXI NI FlexRIO
- 100** PXI DAQ
 - 100 PXI Analog I/O
 - 100 PXI Digital I/O
 - 100 PXI Multifunction I/O
- 107** RF
 - 108 Vector Signal Transceivers
 - 110 Vector Network Analyzers
 - 112 Software Defined Radios
 - 115 NI RFmx
- 116** Instrument Control
- 117** NI Partner Network
 - 117 Types of Partners
 - 118 Hardware Services
 - 119 Education Services
 - 119 Technical Support Services

What Makes NI Different for Test and Measurement

At our core, we're passionate about test technology and improving product performance. We know your research or latest product design will move markets and improve the world we live in. We're here to help you.

We Are Software-Obsessed

NI products are designed for software. From simple USB devices to advanced RF testbeds, engineers working with NI systems see software as a defining element of test.

Our Hardware Is Modular

You may be used to purpose-built boxed instruments; when you need a new measurement or more channels, you buy a whole new box. With NI hardware, you change or add measurements by adding new modules. Just like you upgrade your PC with a new graphics card, you can upgrade your NI test system with a new oscilloscope module.

The NI Ecosystem Is Open

Test engineers benefit most when they combine NI software with NI hardware, but NI hardware works with other (non-LabVIEW) popular programming languages and NI software connects to non-NI hardware. Choose the tools that work for you.

Why NI for Test

Every company says they save you time and money. Here are the challenges NI solves to do it.



Flexibility

Changing designs, market needs, and supply chains challenge product development. Use NI tools to adapt and stay on schedule.



Standardization

Don't spend time and money repeating work. Lower your cost of test by sharing code libraries and hardware architectures amongst all of your test teams.



Quality

NI is known for data throughput, acquisition rates, synchronization, and measurement quality. Better products need better test.





Productivity

You are a critical part of test. NI improves your productivity, so you focus more on what matters to you, your team, and your business.

Find NI Anywhere There Is Test

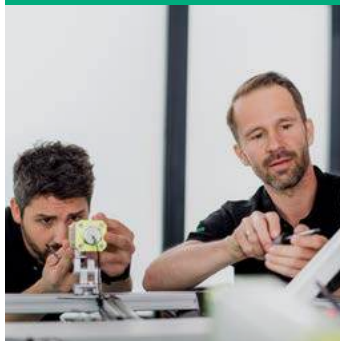
NI works with more than 40,000 customers each year to deliver the test and measurement technology engineers use to create better products, on time, while driving down the cost of test. Find NI anywhere there is test, including:

<p>Quick desktop measurements to test design assumptions</p>	<p>Mechanical and sensor-based tests to validate specifications</p>	<p>Automated software (HIL) test racks to cover the whole test envelope in less time</p>	<p>Manufacturing test systems to improve test quality and throughput</p>
			

Industries Served

- | | |
|---|--|
| <ul style="list-style-type: none"> Semiconductor Electronics (consumer and industrial) Electrical components (motors, switches) White goods and appliances Automotive Aerospace Military and defense | <ul style="list-style-type: none"> Life sciences Academic (teaching and research) Heavy equipment, industrial, and off-highway Commercial and government research labs Energy: Smart grid Energy: Renewables research Energy: O&G mid/downstream and well-servicing |
|---|--|

Companies and Engineers Seeing Success with NI Today

<p>Qorvo</p> <p>2x</p> <p>test throughput and prepared for 5G</p>	<p>Hyundai</p> <p>83%</p> <p>lower development time for new test systems per variant</p>	<p>Honeywell</p> <p>40%</p> <p>reduction in cost of each test station</p>	<p>Philips</p> <p>\$2M+</p> <p>reduction in OpEx per project</p>
---	--	---	--

Philips Rethinks Functional Test, Shortening Time to Market

“The move to a COTS approach using PXI and LabVIEW was critical to this production-test success at Philips. The combination of best-in-class modular hardware along with industry-standard software was pivotal to millions of dollars and hundreds of hours saved in production test engineering.”

Neil Evans
Senior Manager, Philips

Productivity Boost in Postsilicon Validation

“It was never easier to configure the PXI instruments and run automated measurement without much coding in a few minutes of setup time. I believe the powerful combination between InstrumentStudio™ software and TestStand with the sweep loop is an incredible feature that (will) boost our productivity for debugging activities in postsilicon validation.”

Wolfgang Rominger
NXP

NI Hardware Is Modular

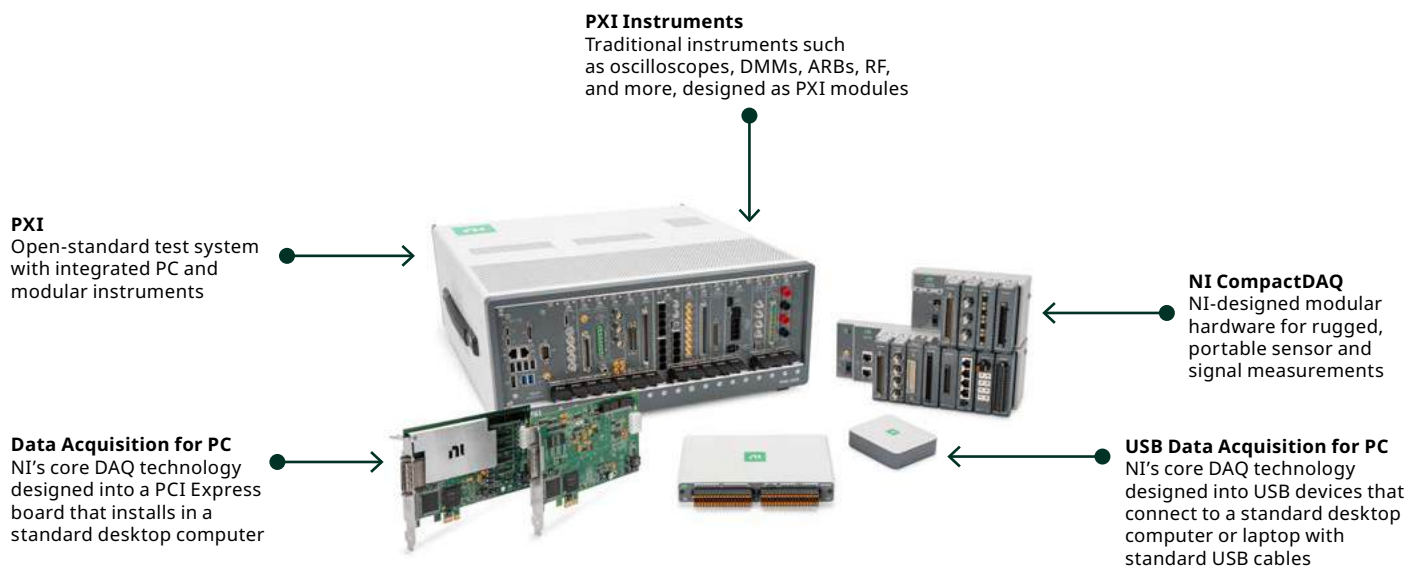

Mix and match NI's modular hardware with a PC to build a custom test and measurement solution for the desktop, lab bench, or production floor.



Why Choose LabVIEW for Test

Our comprehensive software portfolio scales from the instrument to the enterprise, allowing us to serve a complete range of needs, from performing a simple measurement to managing test systems across the globe.

In 1986, we released LabVIEW, and have been the leaders in automated test since. From performing a simple voltage measurement to advancing space missions, LabVIEW has been engineers' tool of choice. Let's take a look at why engineers choose LabVIEW:

Program Like You Think

Graphical data flow in LabVIEW (bottom) is like flowchart logic (top) and considered easier by many to interpret and debug.

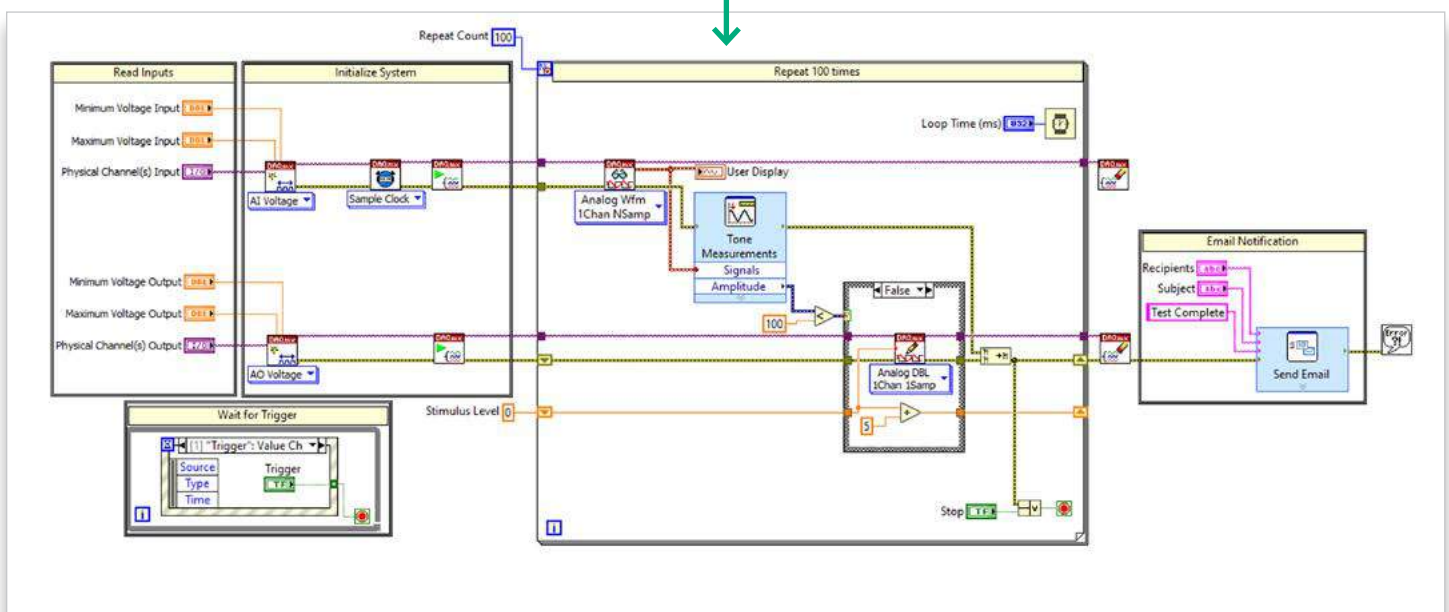
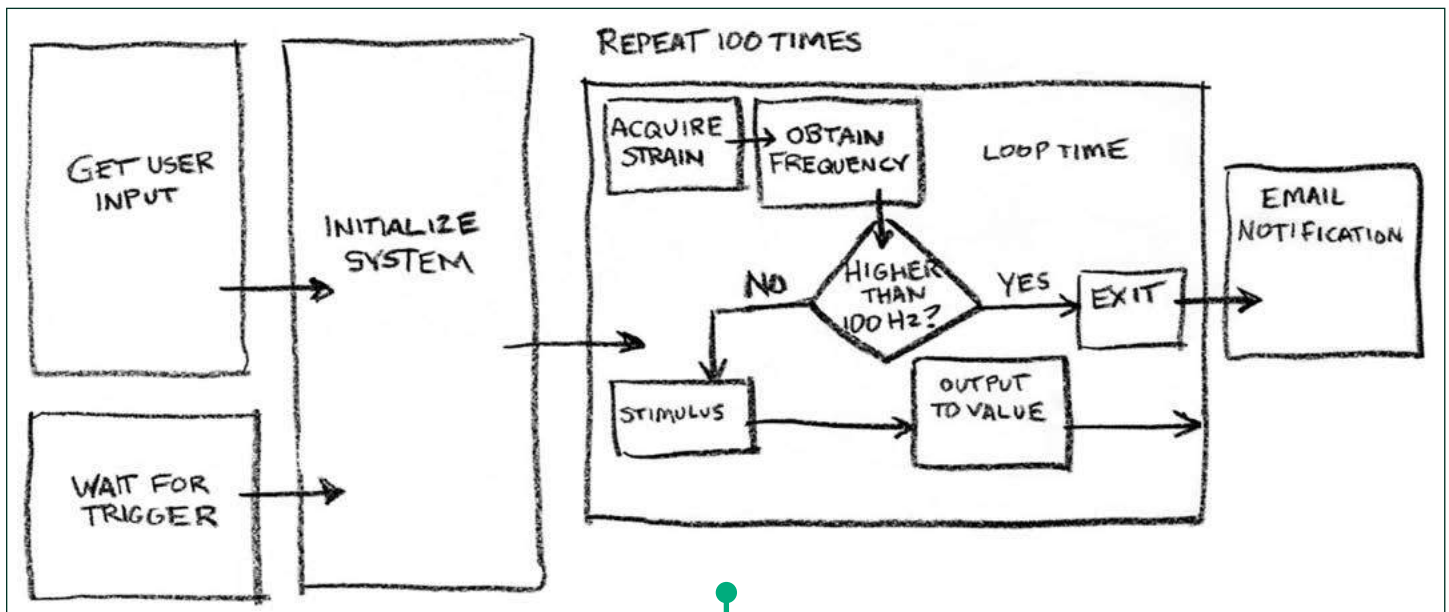

LabVIEW Connects to Everything in Your Test System

Get unparalleled instrument connectivity with LabVIEW – automate NI and non-NI hardware. Any device is accessible and programmable with thousands of available instrument drivers.



Build a Custom User Interface in Minutes

Use drag-and-drop UI elements to build a custom professional test panel. The UI elements in LabVIEW are designed specifically for engineers building test and measurement systems.

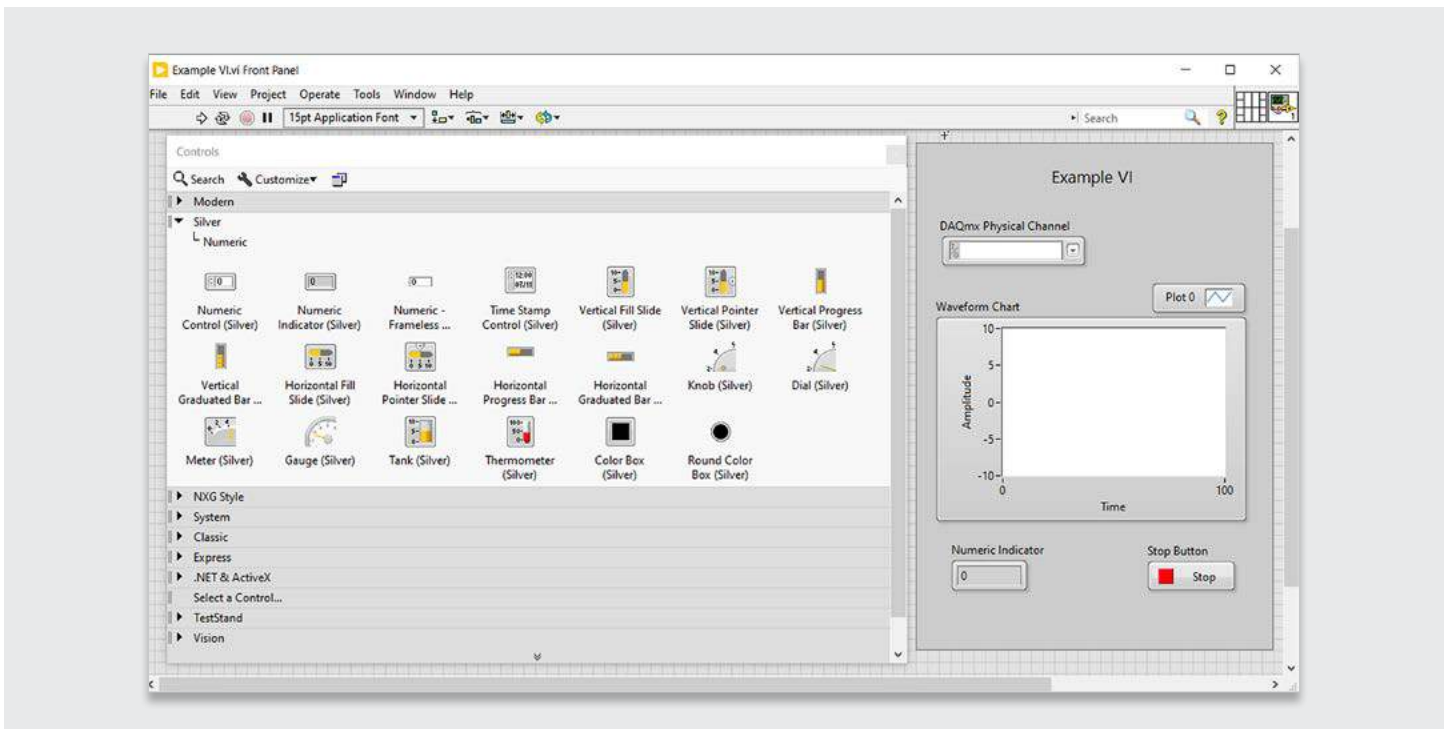

Integrate Code from Other Programming Languages

Add new algorithms and data analysis routines, and connect to other systems with code written in Python, C, and .NET. Language flexibility and integration save time.

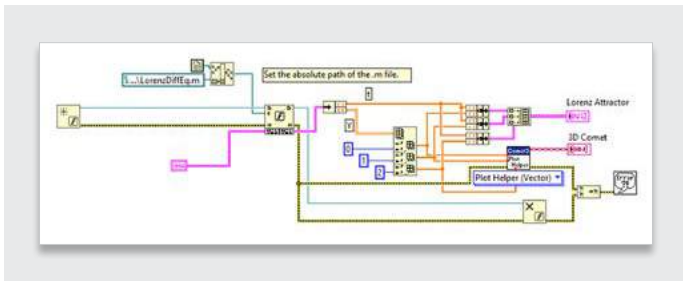

MATLAB®

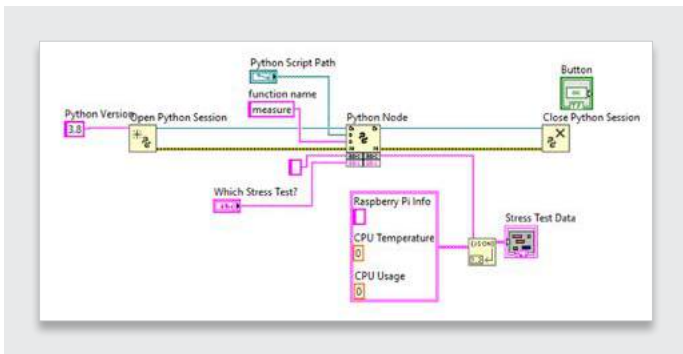

Python

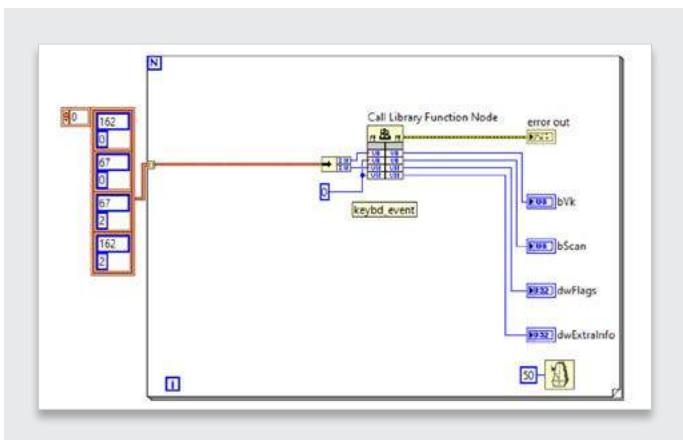

C/C++, C#

Get Access to All the Software You Need in the LabVIEW+ Suite

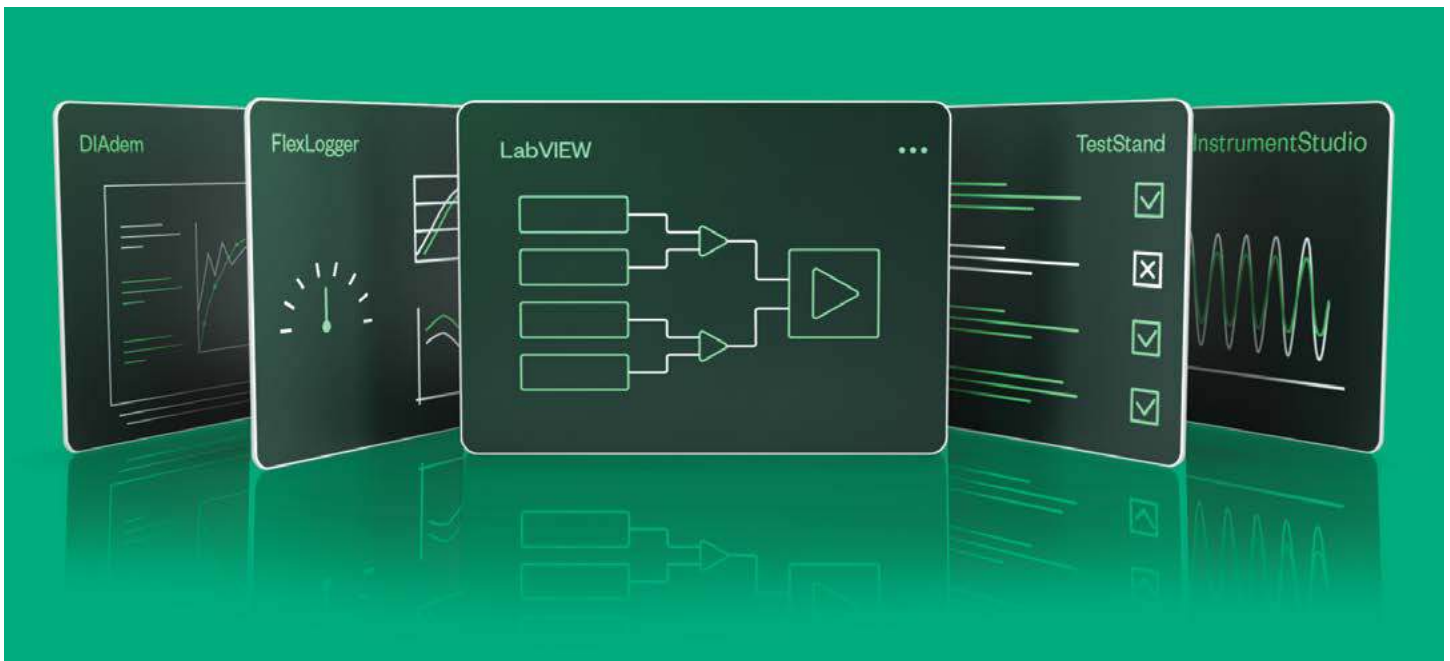

788509-35

It's LabVIEW, plus whole lot more. The LabVIEW+ Suite brings together the best of NI test software that saves engineers time by optimizing every part of their workflow. Each software includes features and capabilities designed to accelerate test:

NI LabVIEW is the industry-leading environment for automated test system development.

NI TestStand is used in validation labs and on manufacturing floors across the world to automate and sequence tests.

NI DIAdem saves engineers hundreds of hours of manual data analysis and report creation with automation.

NI FlexLogger and InstrumentStudio software make measurement and instrument configuration a quicker and interactive process.

The suite provides purpose-built tools for automating measurement, analysis, and test that work together to save you time.

Measure

Take a Quick Measurement

Configure NI hardware channels for sensor, analog, and digital signals

Interactively set up PXI instruments and debug unexpected behavior

Powered by:



Test

Optimize Test for Validation and Production

Create test sequences with code from LabVIEW, Python, C/C++, and .NET

Track units and automatically store test results to your database

Powered by:



Analyze

Interactively Analyze Data

Use built-in engineering analysis functions for calculations

View any type of data, quickly and all at once, with segmented displays

Powered by:



Create and Share Reports

Drag-and-drop to graphics to create shareable reports for your team or organization

Automate your postprocessing routine with VBS or Python

Powered by:



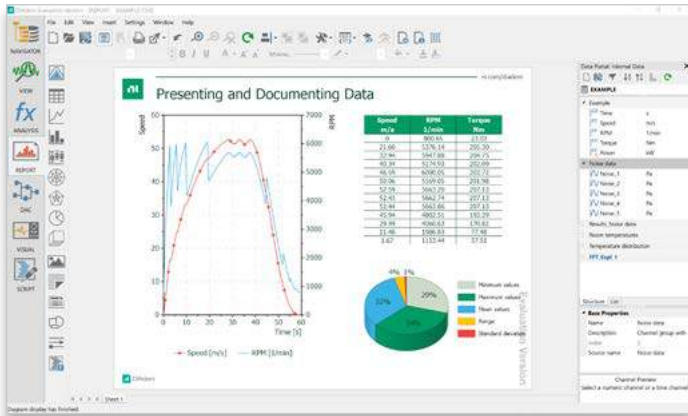

NI DIAdem

Data-analytics software for measurement data search, inspection, analysis, and automated reporting.

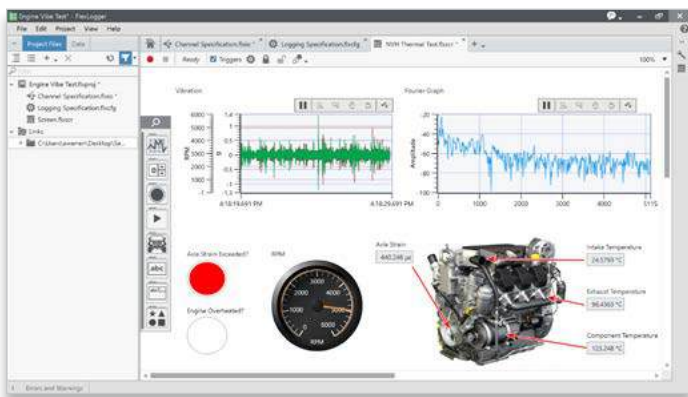

NI FlexLogger Software

No-code software that accelerates measurement configuration and logging with NI DAQ hardware.

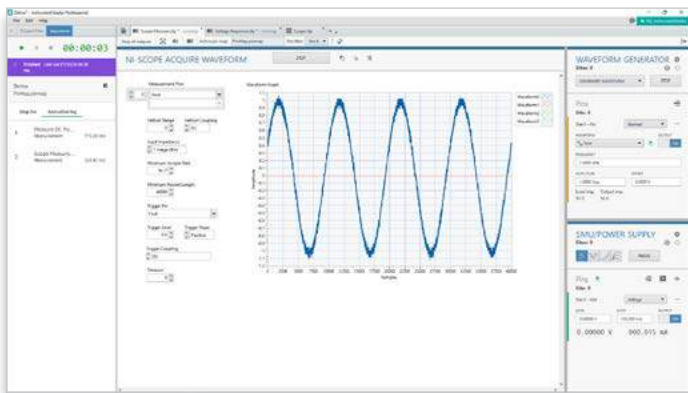

NI InstrumentStudio Software

Instrument configuration software for automating and sequencing measurements.

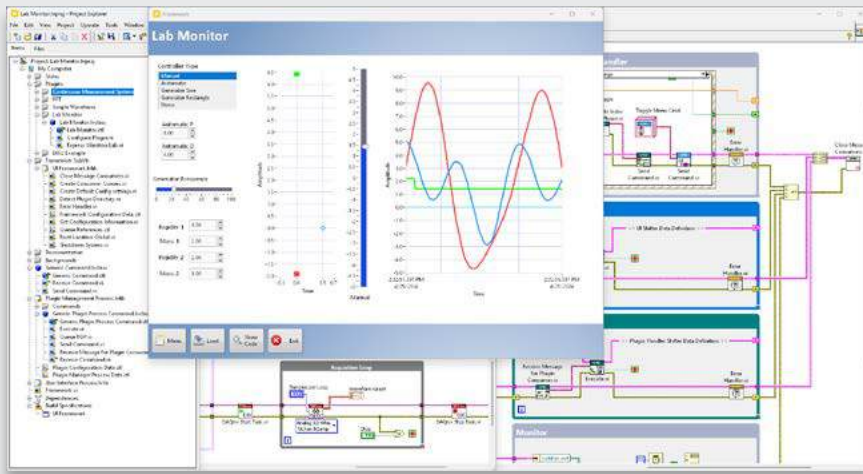

LabVIEW Base
784503-35
Recommended for simple test and measurement applications.

LabVIEW Full
784522-35
Recommended for applications needing advanced analysis or signal processing.

LabVIEW Professional
784584-35
Recommended for engineers who need tools for software engineering, code deployment, distribution, and reporting.

NI LabVIEW

LabVIEW is a graphical programming environment engineers use to develop automated research, validation, and production test systems.

Engineers use LabVIEW to:

- Accelerate the development of flexible test systems
- Automate and control any instrument
- Perform data acquisition, analysis, and report generation

Key Features:

Maximize Productivity

- Graphical Programming**—Visualize your test system with a natural flowchart-like data flow.
- Customizable User Interfaces**—Create custom, interactive UIs with prebuilt objects for real-time data display and user input.

Integrate Everything

- Hardware Access**—Connect to any device with thousands of drivers for third-party instrumentation.
- Code Reuse**—Call Python, C, MATLAB, and .NET code.

Increase Capabilities

- Real-Time and FPGA Modules**—Use add-ons for applications that require embedded hardware and FPGA systems.
- Automated Reporting**—Share test results by generating reports for Microsoft Office or writing to a database, such as MongoDB.

Active Debugging—LabVIEW recompiles code after every action. Identify and resolve issues with no last-minute surprises.

Protocol Support—Exchange data between applications using TCP/IP, UDP, serial, IrDA, Bluetooth, Modbus, SMTP, and many more.

Application Builder—Create and deploy your code as stand-alone applications for others to use in just a few clicks.

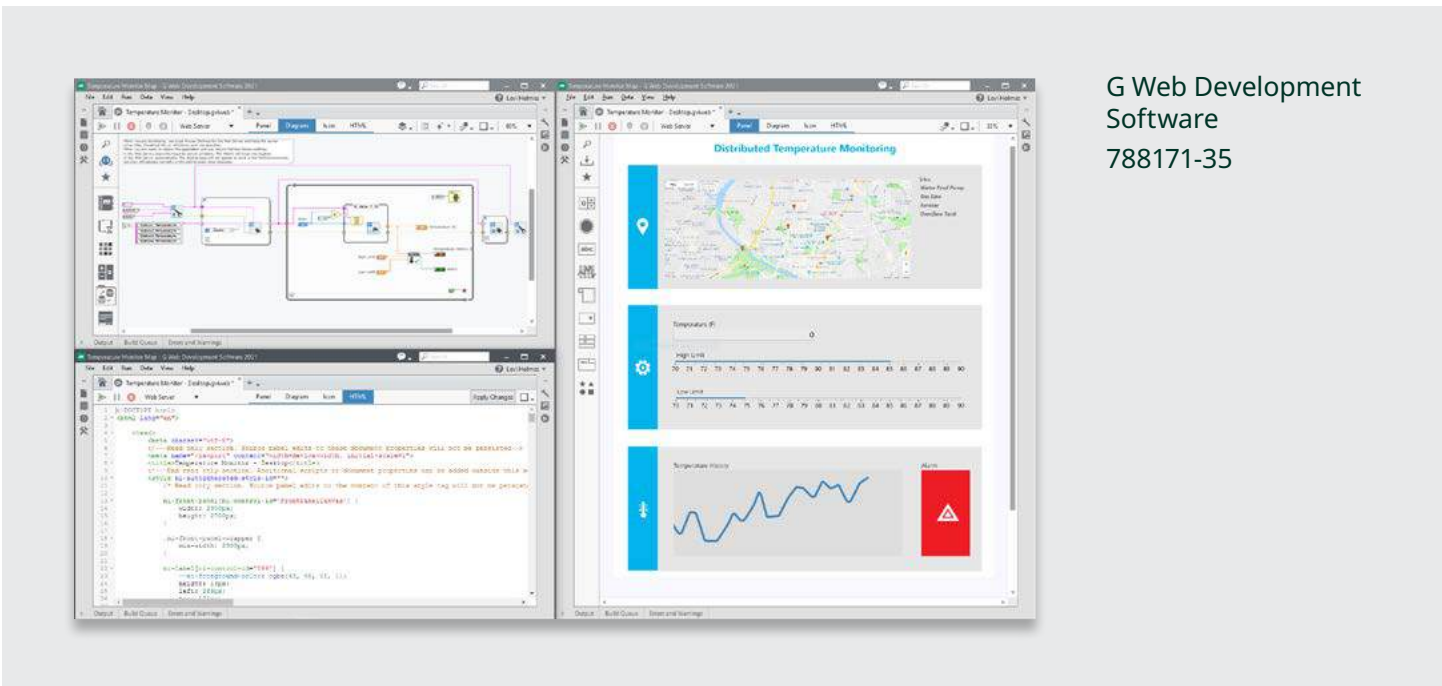

G Web Development Software
788171-35

NI G Web Development Software

G Web Development Software helps engineers create web-based user interfaces for test and measurement applications without traditional web development skills.

Engineers use G Web Development Software to build web apps for:

- Accessing their test system remotely
- Sharing test information with colleagues
- Accessing their test system on another device

Key Features:

- Customizable User Interfaces**—Create custom user interfaces with prebuilt objects for data display and user input.
- Data Communication APIs**—Exchange information with prepackaged APIs that simplify communication. Maintain compatibility with any test system built in LabVIEW, C#, or Python.
- Hosting**—Host your application on your test machine or a dedicated server.

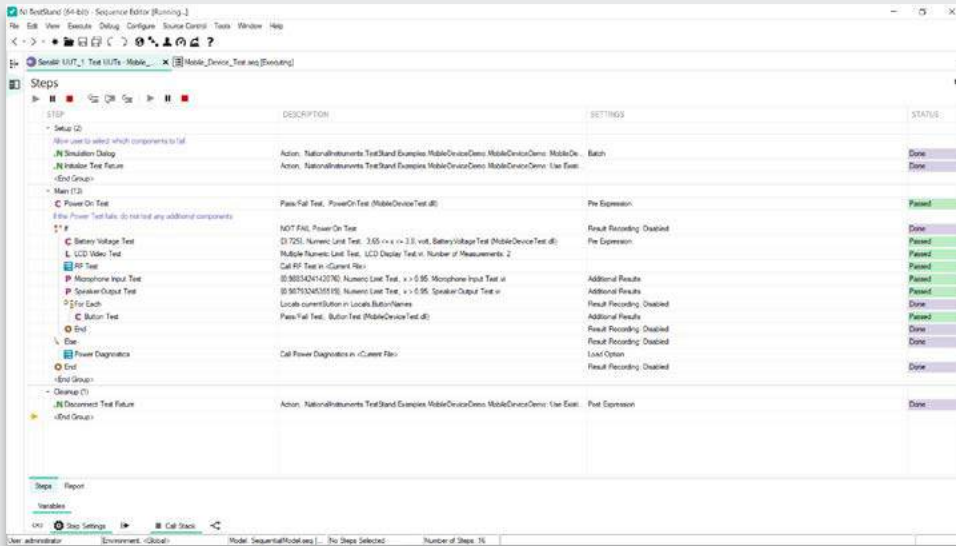

TestStand Development 788372-35

Recommended for engineers developing test sequences.

TestStand Deployment Engine 777774-35

Required for deploying test sequences to additional test systems.

NI TestStand

TestStand is test executive software that accelerates system development and deployment for engineers in validation and production.

Engineers use TestStand to:

- Rapidly develop, deploy, and manage automated test systems
- Test products in parallel to optimize instrument use and test times with built-in autoscheduling intelligence

- Integrate and sequence tests written in various programming languages
- Log and share test results to local and network databases

Key Features:

Develop Systems Faster

Code Adapters—Take advantage of investment in existing code by integrating LabVIEW, C#, C++, Microsoft Visual Basic .NET, and more. Use multiple languages in the same sequence.

Drag-and-Drop Development Environment—Use the TestStand Sequence Editor to quickly sequence, configure, and execute test code modules.

Simplify System Deployment

TestStand Deployment Utility—Easily package all required DLLs, source code, drivers, and configuration information into a single installer.

Deployment Patching—Reduce the difficulty of maintaining deployed test stations by building small deployment patches that can be quickly downloaded and installed on target machines.

Increase Test Throughput

Parallel Test—Scale from single-unit test to multiunit parallel tests. Save hundreds of development hours with this built-in architecture.

Autoschedule Hardware Resources—Maximize utilization by sharing hardware among multiple execution threads.

Record and Publish Test Results

Enterprise Connectivity—Log test results using standard database connectivity or plug-ins for specialized data management systems, such as NI SystemLink™.

Built-In Reporting—Log critical results to several industry-standard report formats, such as ATML, XML, HTML, and ASCII.

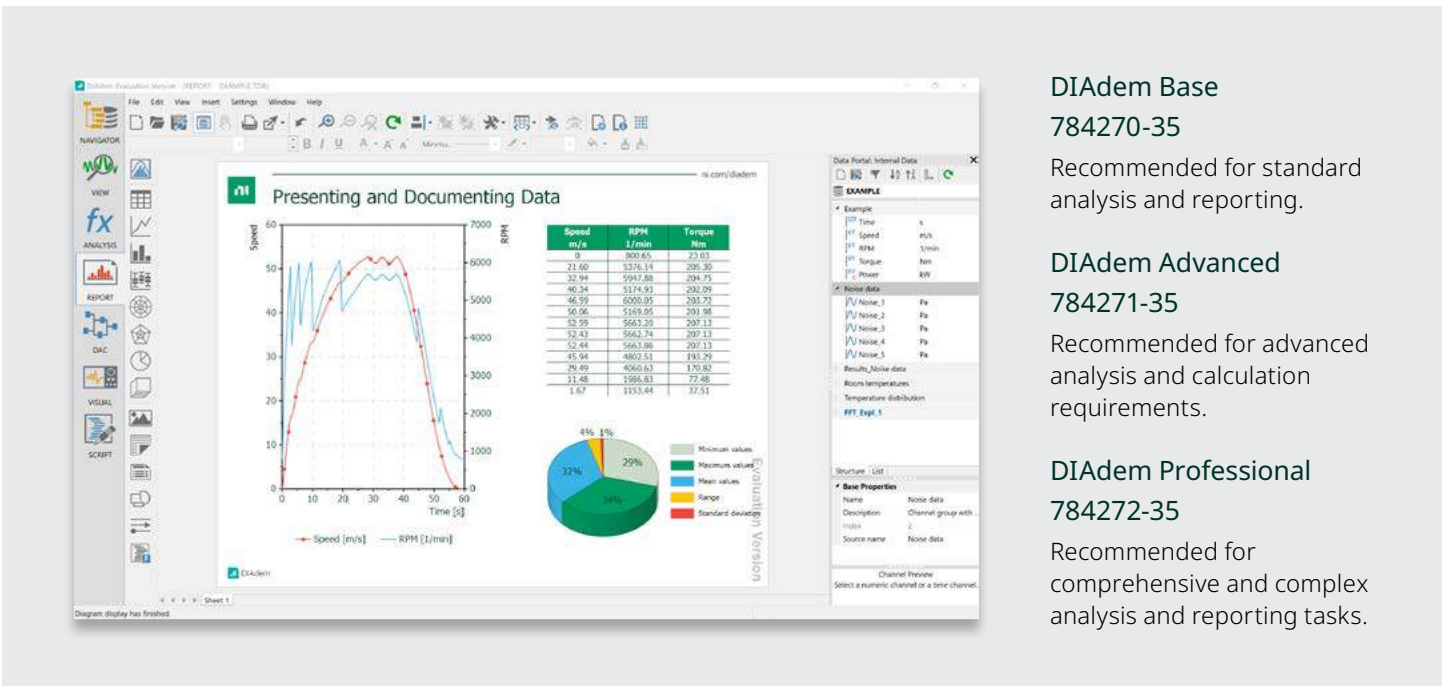

DIAdem Base
784270-35

Recommended for standard analysis and reporting.

DIAdem Advanced
784271-35

Recommended for advanced analysis and calculation requirements.

DIAdem Professional
784272-35

Recommended for comprehensive and complex analysis and reporting tasks.

NI DIAdem

DIAdem is data-analytics software for measurement data search, inspection, analysis, and automated reporting.

Engineers use DIAdem to:

- Search for and find specific data
- Visualize multiple types of test data
- Save time by automating analysis routines and report generation

Key Features:

- DataPlugins**—DIAdem can import more than 1,000 file types through a technology called DataPlugins. Utilize the 200+ existing DataPlugins or create your own using an interactive Wizard or API.
- Data Display**—Instantly display data in multiple 2D-axis systems and tables; play audio and video data; and view map data. Use a paneled display to view multiple datasets with different layouts in one window.
- Built-In Functions**—Transform your data with a simple point-and-click interface to perform analysis.
- Script**—Automate your measurement data analysis workflow, from import to analysis to report, by writing scripts in Python and VBS.

“We have reduced our reporting and analysis time by 95 percent and achieved our goal of replacing the current multistep process with a one-button DIAdem solution.”

Jim Knuff
Raytheon Missile Systems

FlexLogger
785748-3501

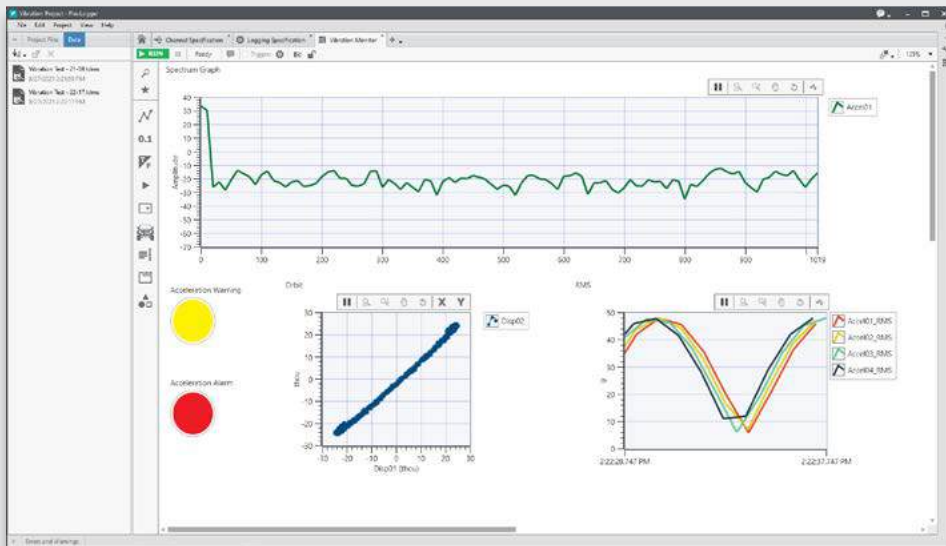

NI FlexLogger™ Software

FlexLogger software is no-code software that accelerates measurement configuration and logging with NI DAQ hardware.

Engineers use FlexLogger software to:

- Quickly acquire data to validate designs or assumptions
- Build configurable test systems with a custom UI for operators
- Log data from sensors and electrical signals to disk

Key Features:

- Calculated Channels**—Perform basic arithmetic on measurement channels and log results to file alongside raw data.
- Alarms and Events**—Set alarms that monitor single channels or groups to be notified of unexpected behavior. Make quick, informed decisions.
- File Configuration**—Store data according to your test needs. Built-in functionality can partition files according to file size or time specifications during for long-running tests. Save to multiple locations to reduce risk of data loss.

FlexLogger Lite

FlexLogger Lite comes free with NI DAQ hardware! It includes standard capabilities such as configuring measurements and saving data. For additional automation and integration of custom measurements, choose the complete version of FlexLogger.

InstrumentStudio
Professional
789987-35

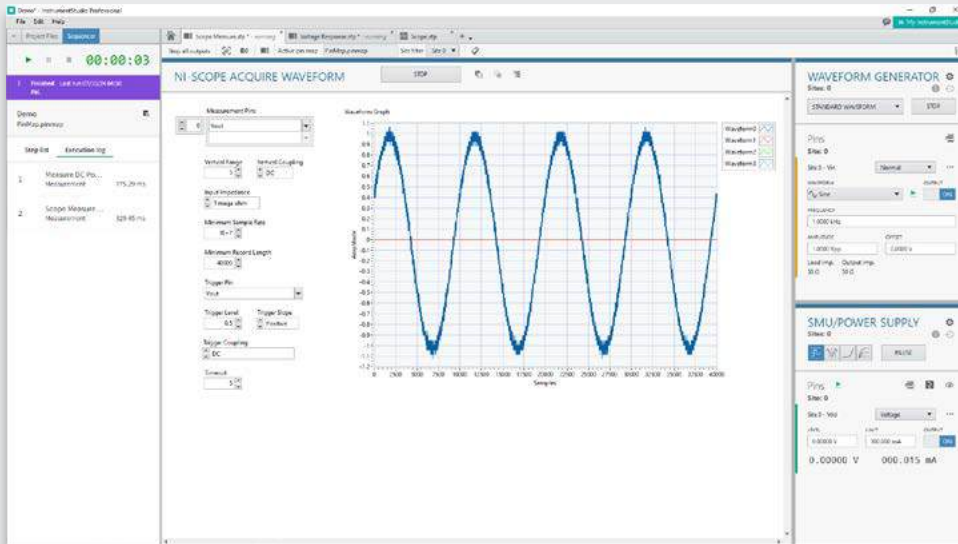

NI InstrumentStudio™ Software

InstrumentStudio is an interactive configuration-based software for engineers to control and configure instruments, run measurements, and develop and debug test sequences within a single environment.

Engineers use InstrumentStudio software to:

- Validate hardware functionality through instrument bring-up, measurement automation, and debugging
- Simultaneously interact with multiple instruments, non-NI hardware, and measurements
- Integrate measurements developed in various programming languages with a common user interface

Key Features:

- Native Panels for NI PXI Instruments**—Control and configure a wide range of DC, analog, digital, RF, and NI instruments with customizable panels
- Measurement Plug-Ins**—Run language-agnostic code modules that can be reused across projects, teams, and sites.
- Develop Test Sequences**—Automate quickly by sequencing instrument and measurement configurations through the sequencer panel. For more advanced validation and production test, utilize copy-paste functionality with TestStand.
- Export Configurations to Code**—Guarantee correlation by replicating instrument configurations in LabVIEW or any other programming environment using a single API function call.

InstrumentStudio

InstrumentStudio comes free with NI PXI instruments, including oscilloscopes, digital multimeters, waveform generators, VSTs, and more! It includes standard capabilities such as configuring instruments, saving data, and exporting instrument configurations. For additional automation and integration of custom measurements, choose InstrumentStudio Professional.

How to Build a PXI Test and Measurement System



1. Chassis

Use the following Controller Selection Table to select your chassis with built-in controller.



2. Controller

For a PXI system with built-in computer:

Shop for a PXI embedded controller just like you would shop for a desktop computer.

To connect a PXI chassis to your laptop using a Thunderbolt™ cable, from the chassis section table, select a chassis with a built-in Thunderbolt cable.



3. Instruments (Modules)

Choose your instruments and measurement modules from the PXI Instrumentation section.



PXI Chassis

NI PXI chassis offer:

Up to 24 GB/s system bandwidth and 8 GB/s per-slot of dedicated bandwidth

Size options ranging from 2 to 18 slots

Hybrid slots for instrumentation flexibility; compatibility with PXI, PXI Express, CompactPCI, and CompactPCI Express modules

Up to 82 W per slot of power and cooling for more advanced I/O modules

Key Features:

Timing and Synchronization

NI PXI Express chassis incorporate a dedicated 10 MHz system reference clock, PXI trigger bus, star trigger bus, and slot-to-slot local bus, as well as a 100 MHz differential system clock, differential signaling, and differential star triggers for advanced timing and synchronization.

Peer-to-Peer Streaming

Use NI PXI Express chassis and software for peer-to-peer communication from a modular instrument to an FPGA module for inline signal processing that bypasses the PXI embedded controller.

Cooling

All NI PXI Express chassis exceed PXI Express requirements by providing at least 38.25 W of power and cooling to every peripheral slot; some chassis push slot cooling capacity even further by providing 58 W or 82 W of cooling to a single slot.

PXI Chassis Modules

Selection Guide	Model	Part Number	Chassis Power-Supply Type	Max System Bandwidth	Slot Cooling Capacity	System Timing Slot	Onboard Clock Type	Slot Count	External Clocking	External Trigger Access
Low Cost, Small Form Factor Chassis, Older-Generation	PXIe-1071	781368-01	AC	3 GB/s	38 W	—	VCXO	Total: 4 Hybrid: 3 PXI Express: 0	—	—
	PXIe-1073	781163-01	AC	250 MB/s	38 W	—	VCXO	Total: 5 Hybrid: 3 PXI Express: 2	—	—
	PXIe-1090	787040-01	AC	2 GB/s	58 W	—	VCXO	Total: 2 Hybrid: 1 PXI Express: 1	✓	—
	PXIe-1083	787026-01	AC	2 GB/s	58 W	—	VCXO	Total: 5 Hybrid: 5 PXI Express: 0	—	—
Entry-Level, Cost-Competitive, Medium Cooling Capacity	PXIe-1082DC	782946-01	DC	8 GB/s	38 W	✓	VCXO	Total: 8 Hybrid: 4 PXI Express: 3	✓	—
	PXIe-1084	784058-01	AC	4 GB/s	58 W	—	VCXO	Total: 18 Hybrid: 17 PXI Express: 0	—	—
		786397-01							✓	✓
	PXIe-1085	783588-01	AC	24 GB/s	38 W	✓	VCXO	Total: 18 Hybrid: 16 PXI Express: 1	✓	—
	PXIe-1086	781720-01	AC	12 GB/s	38 W	✓	VCXO	Total: 18 Hybrid: 16 PXI Express: 1	✓	—
	PXIe-1086DC	787137-01	DC	12 GB/s	38 W	✓	VCXO	Total: 18 Hybrid: 16 PXI Express: 1	✓	—
PXIe-1088	784782-01	AC	8 GB/s	58 W	—	VCXO	Total: 9 Hybrid: 8 PXI Express: 0	—	—	
Highest Performance, Newest-Generation, Highest Cooling Capacity	PXIe-1092	784781-01	AC	24 GB/s	82 W	✓	VCXO	Total: 10 Hybrid: 7 PXI Express: 0	—	—
		786991-01					OCXO		✓	✓
	PXIe-1095	783882-01	AC	24 GB/s	82 W	✓	VCXO	Total: 18 Hybrid: 5 PXI Express: 11	—	—
		785971-01					OCXO		✓	✓

PXI Chassis Accessories

MXI-Express Cable

Part Number	779500-01	779500-03	779500-07
Description	MXI-Express Cable, Gen 1 X1, Copper, 1 m	MXI-Express Cable, Gen 1 X1, Copper, 3 m	MXI-Express Cable, Gen 1 X1, Copper, 7 m
PXIe-1073	✓	✓	✓

PXI Chassis Trigger Cable

Part Number	149055-0R2
Description	Chassis D-SUB Trigger Breakout Cable To 6 BNC For PFI 0-3, Remote Inhibit and Fault, 20 CM
PXIe-1084	✓
PXIe-1092 Timing and Synchronization (786991-01)	✓
PXIe-1095 Timing and Synchronization (785971-01)	✓

PXI Rack-Mount Kit

Part Number	788347-01	778948-01	778644-01	778644-02	787525-01	781634-01	786371-01	786372-01	786969-01	786970-01
Description	PXIe-1090 Chassis Rack-Mount Kit	PXI-103X and 107x Rack-Mount Kit	PXI 18-Slot Front Rack-Mount Kit	PXI 18-Slot Rear Rack-Mount Kit	Rack-Mount Kit For PXIe-1088	Rack-Mount Kit For PXIe-1078 and PXIe-1088 (Legacy)	PXI 18-Slot Front Rack-Mount Kit, Extended Recess	PXI 18-Slot Rear Rack-Mount Kit, Extended Recess	PXIe-1092 Chassis Front Rack-Mount Kit, Extended Recess	PXIe-1092 Chassis Rear Rack-Mount Kit, Extended Recess
PXIe-1090	✓	—	—	—	—	—	—	—	—	—
PXIe-1071	—	✓	—	—	—	—	—	—	—	—
PXIe-1083	—	✓	—	—	—	—	—	—	—	—
PXIe-1073	—	✓	—	—	—	—	—	—	—	—
PXIe-1086DC	—	—	✓	✓	—	—	—	—	—	—
PXIe-1086	—	—	✓	✓	—	—	—	—	—	—
PXIe-1088	—	—	—	—	✓	✓	—	—	—	—
PXIe-1084 Timing and Synchronization (786397-01)	—	—	—	—	—	—	✓	✓	—	—
PXIe-1084	—	—	—	—	—	—	✓	✓	—	—
PXIe-1085	—	—	✓	✓	—	—	—	—	—	—
PXIe-1092 Timing and Synchronization (786991-01)	—	—	—	—	—	—	—	—	✓	✓
PXIe-1095	—	—	—	—	—	—	✓	✓	—	—
PXIe-1095 Timing and Synchronization (785971-01)	—	—	—	—	—	—	✓	✓	—	—

Thunderbolt 3 Male-to-Male Cable

Part Number	785607-02	785608-02	787580-0R8
Description	Thunderbolt 3 Type-C Cable, Active 40 Gb/S, 3A, 2 m	Thunderbolt 3 Type-C Cable, Passive 20 Gb/S, 5A, 2 m	Thunderbolt 3 Type-C Cable, Passive 40 Gb/S, 5A, 0.8 m
PXIe-1090	✓	✓	✓
PXIe-1083	✓	✓	✓

HDMI Trigger Cable

Part Number	148864-01	148864-02	149055-0R2
Description	HDMI Cable for Trigger Routing (1 m)	HDMI Cable for Trigger Routing (2 m)	Chassis Trigger Breakout Cable (0.2 m)
PXIe-1084 Timing and Synchronization (786397-01)	✓	✓	✓
PXIe-1092 Timing and Synchronization (786991-01)	✓	✓	✓
PXIe-1092	✓	✓	✓
PXIe-1095	✓	✓	✓
PXIe-1095 Timing and Synchronization (785971-01)	✓	✓	✓

Power Supply Replacement

Part Number	782106-01	782107-01	784057-01	781719-01	786300-01
Description	Replacement Power Supply for NI PXIe-1066DC and PXIe-1086DC	Replacement Power Supply for NI PXIe-1066DC and PXIe-1086DC —for EU	Power Supply Filler Panel for PXIe-1066DC and PXIe-1086DC	Replacement Power Supply for PXIe-1085	Upgrade/ Replacement Power Supply for PXIe-1092 or PXIe-1095
PXIe-1086DC	✓	✓	✓	—	—
PXIe-1086	✓	✓	✓	—	—
PXIe-1085	—	—	—	✓	—
PXIe-1092 Timing and Synchronization (786991-01)	—	—	—	—	✓
PXIe-1092	—	—	—	—	✓
PXIe-1095	—	—	—	—	✓
PXIe-1095 Timing and Synchronization (785971-01)	—	—	—	—	✓

Fan Replacement Kits

Part Number	784854-01	786324-02	786972-01	786324-01
Description	Chassis Fan Replacement Kit for PXIe-1078 and PXIe-1088	Replacement Fan Assembly for NI PXIe-1084	Fan Replacement Kit for PXIe-1092 Chassis	Replacement Fan Assembly for NI PXIe-1095
PXIe-1088	✓	—	—	—
PXIe-1084 Timing and Synchronization (786397-01)	—	✓	—	—
PXIe-1084	—	✓	—	—
PXIe-1092	—	—	✓	—
PXIe-1092 Timing and Synchronization (786991-01)	—	—	✓	—
PXIe-1095	—	—	—	✓
PXIe-1095 Timing and Synchronization (785971-01)	—	—	—	✓

NI PXI Carrying Case

Part Number	780398-01
Description	PXI Carrying Case for Midsize Chassis (10 Slots or Fewer)
PXIe-1083	✓
PXIe-1073	✓
PXIe-1071	✓
PXIe-1088	✓
PXIe-1092 Timing and Synchronization (786991-01)	✓
PXIe-1092	✓



PXI Controllers

With NI PXI controllers, take advantage of:

The latest high-performance Intel processors, with up to 18 cores available

OSs: Windows 11, Windows 10, Windows 7, Linux Desktop (RHEL, OpenSUSE, Ubuntu), NI Linux Real-Time Memory and storage up to 512 GB and 64 GB, respectively

Solid-state drives, Thunderbolt 3, USB 3.0, Gigabit Ethernet, and other peripheral ports

Key Features:

High Performance

NI maintains close partnerships with key processor manufacturers, including Intel and Advanced Micro Devices, so NI controllers feature the latest processors, such as the Intel Atom, Core i7, and Xeon.

Durability

NI offers PXI controllers with solid-state drives (SSDs) so that you can test under a wide range of conditions. Controllers with SSDs are designed to operate in extreme shock, high altitude, and random vibration environments.

Data Security

The Trusted Platform Module, a secure cryptoprocessor, is a component on select embedded controllers specifically designed to elevate platform security above the capabilities of today's software by providing a protected space for key operations and other security-critical tasks.

PXI Controller Modules

Selection Guide	Model	Part Number	Controller OS	Processor	Cores	Max Controller Bandwidth	Hard Drive Memory Size	HDD Removable	TPM Version*
Good, Intel Core i3	PXIe-8822	787881-00	No OS	11th Gen Intel® Core™ i3- 11100HE	4	4 GB/s	512 GB	—	—
		787881-01	Windows 10 64-bit						2.0 (Infineon/ST, Global Market)
		787881-0118							2.0 (Nations Tech, China Market)
		787881-33	LabVIEW Real- Time (NI Linux Real-Time)						—
		788815-01	Windows 11						2.0 (Infineon/ST, Global Market)
		788815-0118							2.0 (Nations Tech, China Market)
Better, Intel Core i5	PXIe-8842	787882-00	No OS	11th Gen Intel® Core™ i5- 11500HE	6	8 GB/s	512 GB	—	2.0 (Infineon/ST, Global Market)
		787882-01	Windows 10 64-bit						2.0 (Infineon/ST, Global Market)
		787882-0118							2.0 (Nations Tech, China Market)
		787882-33	LabVIEW Real- Time (NI Linux Real-Time)						—
		788816-01	Windows 11						2.0 (Infineon/ST, Global Market)
		788816-0118							2.0 (Nations Tech, China Market)
Best, Intel Core i7	PXIe-8862	787987-00	No OS	11th Gen Intel® Core™ i7- 11850HE	8	16 GB/s	512 GB	—	2.0 (Infineon/ST, Global Market)
		787987-01	Windows 10 64-bit				512 GB	—	2.0 (Infineon/ST, Global Market)
		787987-0118					512 GB	—	2.0 (Nations Tech, China Market)
		788167-01					960 GB	U.2, Removable	2.0 (Infineon/ST, Global Market)
		789546-01					512 GB	—	—
		787987-33	LabVIEW Real- Time (NI Linux Real-Time)				512 GB	—	—
		788167-33					960 GB	U.2, Removable	—
		788817-01	Windows 11				512 GB	—	2.0 (Infineon/ST, Global Market)
		788817-0118					512 GB	—	2.0 (Nations Tech, China Market)
		788818-01					960 GB	U.2, Removable	2.0 (Infineon/ST, Global Market)

(continued on next page)

PXI Controller Modules (continued)

Selection Guide	Model	Part Number	Controller OS	Processor	Cores	Max Controller Bandwidth	Hard Drive Memory Size	HDD Removable	TPM Version*
Extreme, Server-Grade	PXIe-8881	787807-01	Windows 10 64-bit	Intel® Xeon W-2225, Xeon Quad-Core	4	24 GB/s	512 GB	—	2.0 (Infineon/ST, Global Market)
		787807-0118							—
		786636-01							2.0 (Infineon/ST, Global Market)
		786636-0118							—
		787805-01							—
		786636-00	No OS	Intel® Xeon W-2245, Xeon 8-Core	8	24 GB/s	512 GB	—	2.0 (Infineon/ST, Global Market)
		787805-33	LabVIEW Real-Time (NI Linux Real-Time)						—
		789431-01	Windows 11						2.0 (Infineon/ST, Global Market)
		789431-0118							2.0 (Nations Tech, China Market)
		787806-01	Windows 10 64-bit	Intel® Xeon W-2295, Xeon 18-Core	18	24 GB/s	512 GB	—	2.0 (Infineon/ST, Global Market)
		787806-0118							—

* TPM Versions

In order to run Windows 11 on your PC, it must be installed with Trusted Platform Module (TPM) 2.0. The latest NI controllers offer TPM support. Please see the table above for regional TPM types and restrictions; currently, Global Market and China Market. Please contact NI support with questions.

PXI Rack-Mount Controller Modules

Model	Part Number	Processor	Controller OS	RAM	Storage	PCI Express	Video	Ports
NI RMC-8356 for PXI Express Control (Windows)	785321-01	Intel Xeon E5620 (2.4G Hz Quad Core)	Windows 10 64-bit	16 GB–64 GB DDR4	1 TB HDD + 3 Additional Bays	3.0 x 16, 1 Slot (for Remote Control)	2 Display Ports, 1 DVI, 1 VGA	2 USB 3.0, 4 USB 2.0, 2 Gigabit Ethernet RJ-45
NI RMC-8354 1U Controller, Core I7-860, 1X 500 GB, Real-Time Software	781650-33	Intel Core i7-860 (2.8 GHz)	LabVIEW Real-Time OS	1 GB (Included)	500 GB	Gen 1 MXI	—	—

Controller Accessories

Hard Drives

Hard Drive	1 TB NVMe Solid-State Drive Upgrade For PXIe-8822/8842/8862, M.2, 80 mm	Spare 512 GB NVMe Solid-State Drive for PXIe-8822/8842/8862, M.2, 80 mm	Spare 512 GB NVMe Solid-State Drive, M.2, 80 mm
Part Number	788898-01	788897-01	786775-01
PXIe-8822	✓	✓	—
PXIe-8842	✓	✓	—
PXIe-8862	✓	✓	—
PXIe-8881	—	—	✓

RAM

RAM	16 GB DDR4 3200 SO-DIMM RAM for PXIe-8822/8842/8862	16 GB DDR4 2666 SO-DIMM RAM, ECC for PXIe-8881	16 GB DDR4 2666 SO-DIMM RAM, ECC for PXIe-8881
Part Number	788899-01	787659-01	787659-01
PXIe-8822 [787881-01]	✓	✓	—
PXIe-8822 [787881-0118]	✓	✓	—
PXIe-8822 [787881-33]	✓	✓	—
PXIe-8822 [788815-01]	✓	✓	—
PXIe-8822 [788815-0118]	✓	✓	—
PXIe-8842 [787882-01]	✓	✓	—
PXIe-8842 [787882-0118]	✓	✓	—
PXIe-8842 [787882-33]	✓	✓	—
PXIe-8842 [788816-01]	✓	✓	—
PXIe-8842 [788816-0118]	✓	✓	—
PXIe-8862 [787987-01]	✓	✓	—
PXIe-8862 [787987-0118]	✓	✓	—
PXIe-8862 [787987-33]	✓	✓	—
PXIe-8862 [788817-01]	✓	✓	—
PXIe-8862 [788817-0118]	✓	✓	—
PXIe-8862 [788818-01]	✓	✓	—
PXIe-8862 [789546-01]	✓	✓	—
PXIe-8881 [786636-01]	—	—	✓
PXIe-8881 [786636-0118]	—	—	✓
PXIe-8881 [787805-01]	—	—	✓
PXIe-8881 [787805-33]	—	—	✓
PXIe-8881 [787807-01]	—	—	✓
PXIe-8881 [787807-0118]	—	—	✓
PXIe-8881 [789431-01]	—	—	✓
PXIe-8881 [789431-0118]	—	—	✓



PXI Remote Controllers and System Expansion

Achieve the ultimate flexibility with PXI remote controllers:

- Control a PXI chassis from a desktop PC, laptop, or rack-mount controller
- Create synchronized, data-connected, multichassis PXI systems
- Choose from copper and fiber-optic cable options
- Take advantage of a software-transparent link requiring no programming

Key Features:

Desktop or Rack-Mount PC Control

With a PXI remote control module, a host computer can establish a PCI Express connection to the chassis using a compatible MXI-Express Cable.

Multichassis Synchronization

PXI remote control modules can leverage the architecture of the PXI platform to achieve high-accuracy synchronization between modular instruments in separate chassis. By combining NI's timing and synchronization modules with MXI-Express, you can synchronize instruments across multiple chassis with NI-TClk technology deskewing.

Flexible Topologies

While a daisy-chaining topology is the most common approach to building multichassis systems, some host interface cards support star topologies so that each chassis can communicate directly with the host.

PXI Remote Control Modules

Selection Guide	Model	Part Number	Type	MXI Bandwidth	MXI Communication Level	MXI Ports	Supported Cable Type	Supports Daisy-Chaining
Entry	PXIE-8361	779700-02	PXI Remote Control Module	250 MB/s	MXI-Express x1	1	Copper	—
	PCIE-8363	788814-01	Host Interface	—	MXI-Express x1	1	Copper	—
	PXIE-8364	781819-01	Bus Extension Module	250 MB/s	MXI-Express x1	—	Copper	—
	PXIE-8374	781820-04	Bus Extension Module	1 GB/s	MXI-Express x4	—	Copper	—
Midrange	PXIE-8381	782362-01	PXI Remote Control Module	4 GB/s	MXI-Express Gen2 x8	1	Copper	—
	PCIE-8382	779933-01	Host Interface	—	MXI-Express Gen2 x8	1	Copper	—
	PCIE-8383	789542-01	Host Interface	—	MXI-Express Gen2 x8	1	Copper	—
	PXIE-8384	782363-01	Bus Extension Module	4 GB/s	MXI-Express Gen2 x8	—	Copper	—
Performance	PXIE-8398	784178-01	PXI Remote Control Module	16 GB/s	MXI-Express Gen3 x16	4	Copper and Fiber-Optic	✓
	PXIE-8399	784180-01	PXI Remote Control Module	16 GB/s	MXI-Express Gen3 x16	8	Copper and Fiber-Optic	✓
	PCIE-8398	784179-01	Host Interface	—	MXI-Express Gen3 x16	1	Copper and Fiber-Optic	—
	PXIE-8394	785157-01	See Below*	7.9 GB/s	MXI-Express Gen3 x8	—	Copper and Fiber-Optic	—
Thunderbolt	PXIE-8301	785679-01	PXI Remote Control Module	2.3 GB/s	Thunderbolt 3.0	2	Copper	—

*PXIE-839X Gen 3: Through modular cabling and/or the PXIE-8394 Gen 3 x8 bus extension module, several multichassis system configurations are possible. [Please refer to the product flyer.](#)

PXI Remote Control Module Accessories

PXI Remote Control Module Cables

Cable Type	Thunderbolt 3 Type-C Cable, Active 40 GB/S, 3A, 2 m	Thunderbolt 3 Type-C Cable, Passive 20 GB/S, 5A, 2 m	Thunderbolt 3 Type-C Cable, Passive 40 GB/S, 5A, 0.8 m	MXI-Express Cable, Gen 1 x1, Copper, 1 m	MXI-Express Cable, Gen 1 x1, Copper, 3 m
Part Number	785607-02	785608-02	787580-0R8	779500-01	779500-03
PXIE-8301	✓	✓	✓	—	—
PXIE-8361	—	—	—	✓	✓
PCIE-8368	—	—	—	—	✓
PCIE-8382	—	—	—	—	—
PCIE-8383	—	—	—	—	—
PXIE-8381	—	—	—	—	—
PCIE-8398	—	—	—	—	—
PXIE-8398	—	—	—	—	—
PXIE-8399	—	—	—	—	—
PXIE-8374	—	—	—	✓	✓
PXIE-8384	—	—	—	—	—
PXIE-8394	—	—	—	—	—
PXIE-8364	—	—	—	✓	✓

PXI Remote Control Module Cables (continued)

Cable Type	MXI-Express Cable, Gen 1 x1, Copper, 7 m	MXI-Express Cable, Gen 2 x8, Copper, 1 m	MXI-Express Cable, Gen 2 x8, Copper, 2 m	MXI-Express Cable, Gen 2 x8, Copper, 3 m	MXI-Express Cable, Gen 2 x8, Copper, 5 m
Part Number	779500-07	782317-01	782317-02	782317-03	782317-05
PXIe-8301	—	—	—	—	—
PXIe-8361	✓	—	—	—	—
PCIE-8368	—	—	—	—	—
PCIE-8382	—	✓	✓	✓	✓
PCIE-8383	—	✓	✓	✓	✓
PXIe-8381	—	✓	✓	✓	✓
PCIE-8398	—	—	—	—	—
PXIe-8398	—	—	—	—	—
PXIe-8399	—	—	—	—	—
PXIe-8374	✓	—	—	—	—
PXIe-8384	—	✓	✓	✓	✓
PXIe-8394	—	—	—	—	—
PXIe-8364	✓	—	—	—	—

PXI Remote Control Module Cables (continued)

Cable Type	MXI-Express Cable, Gen 3 x4, Copper, 3 m	MXI-Express Cable, Gen 3 x8, Copper, 1 m	MXI-Express Cable, Gen 3 x8, Copper, 3 m	MXI-Express Cable, Gen 3 x4, Fiber-Optic, 10 m	MXI-Express Cable, Gen 3 x4, Fiber-Optic, 100 m	MXI-Express Cable, Gen 3 x4, Fiber-Optic, 30 m
Part Number	785549-03	785550-01	785550-03	788302-10	788302-100	788302-30
PXIe-8301	—	—	—	—	—	—
PXIe-8361	—	—	—	—	—	—
PCIE-8368	—	—	—	—	—	—
PCIE-8382	—	—	—	—	—	—
PCIE-8383	—	—	—	—	—	—
PXIe-8381	—	—	—	—	—	—
PCIE-8398	✓	✓	✓	✓	✓	✓
PXIe-8398	✓	✓	✓	✓	✓	✓
PXIe-8399	✓	✓	✓	✓	✓	✓
PXIe-8374	—	—	—	—	—	—
PXIe-8384	—	—	—	—	—	—
PXIe-8394	✓	✓	✓	✓	✓	✓
PXIe-8364	—	—	—	—	—	—

PXI Instrument Overview



PXI Oscilloscopes Page 36

- Sample at speeds of up to 12.5 GS/s
- 5 GHz of analog bandwidth
- Numerous triggering modes
- Up to 24-bit resolution



PXI Digital Multimeters Page 41

- Voltage measurements up to 1,000 VDC
- Current measurements up to 3 A
- Resistance measurements up to 5 G Ω
- Isolated digitizer mode up to 1.8 MS/s



PXI Waveform Generators Page 43

- Up to two 16-bit channels per module
- 800 MS/s with 20, 40, and 80 MHz bandwidth
- Up to 34 channels to build parallel
- Max ± 12 V and min ± 7.75 mV output ranges



PXI Counter/Timers Page 45

- Up to eight 32-bit counter/timers
- TTL/CMOS-compatible digital I/O
- Up to 80 MHz measure frequency
- Onboard high-precision oscillators



PXI Power Supplies Page 47

- Two isolated, 60 W channels per module
- Hardware timing and triggering
- Output disconnect relays
- Four-wire remote sense



PXI Switches Page 49

- Electromechanical, reed, solid-state, FET
- Up to 150 V or 2 A
- Up to 544 crosspoints in a single PXI slot
- 1- and 2-wire options



PXI Source Measure Units (SMUs) Page 59

- Up to 24 channels (408 per chassis)
- Up to 200 V and 3 A (10 A pulse)
- Current sensitivity down to 10 fA
- Max power per channel of 40 W (500 W pulse)



PXI LCR Meter and SMUs Page 63

- AC stimulus frequency up to 2 MHz
- AC stimulus amplitude up to 7.07 V_{rms}
- DC bias up to ± 40 V
- Basic impedance accuracy of 0.05%



PXI Digital Pattern Instruments Page 65

- 32-channel module (up to 512 per chassis)
- 100 MHz vector rate, 39 ps displacement
- Digital voltage of -2 V to 6 V
- Up to 200 Mb/s data rate



PXI Digital Waveform Instruments Page 67

- Standard TTL/CMOS interface voltages and programmable voltage levels
- 32 bidirectional digital channels
- Advanced waveform sequencing and streaming features



PXI Electronic Loads Page 70

- Ability to sink up to 300 W of DC power
- Voltage and current measurements with sample rates up to 1.8 MS/s and update rates up to 100 kS/s
- Hardware timing and triggering
- Four-wire remote sense



PXI High-Speed Serial Page 72

- Up to 48 Xilinx MGT (Multigigabit Transceivers) with line rates up to 28.2 Gb/s
- Various high-speed serial protocols on the user-programmable Xilinx Kintex UltraScale+ or 7 series FPGAs
- High-speed P2P backplane data streaming up to 7 GB/s to host, disk, or other PXI Express modules
- Up to 20 GB onboard DDR3 DRAM



PXI Timing and Synchronization Page 75

- Generate high-stability PXI system reference clocks and high-resolution sample clocks
- Achieve synchronization over long distance through GPS, IEEE 1588, IRIG-B, or PPS
- Develop advanced timing and sync applications with NI-Sync and NI-TClk software
- Import and export system reference clocks for synchronization between multiple chassis or external devices



PXI Sound and Vibration Page 77

- Built-in high-pass filtering
- Reliable dynamic signal characterization
- Per-channel, software-selectable AC input coupling
- Per-channel, software-selectable input gain settings



PXI Signal Conditioning Modules Page 80

- High channel density for conditioned and sensor measurements
- Flexible, synchronized, and accurate measurements
- Isolated measurement options
- Swappable front mount terminal block



PXI DAQ Page 100

- High resolution
- High-accuracy measurements
- Advanced timing technology
- A family of products built around flexibility



PXI Reconfigurable I/O (FPGA) Page 85

- Variety of onboard FPGA options
- 12-bit to 18-bit analog input resolution
- Up to 16 analog channels and 96 bidirectional channels
- Up to 1 MS/s analog sample rate



PXI FlexRIO Page 88

- Analog I/O up to 6.4 GS/s, digital I/O up to 1.25 Gb/s, RF I/O up to 4.4 GHz
- High-performance Xilinx FPGAs with up to 20 GB of onboard DRAM
- Program with LabVIEW FPGA or Xilinx Vivado
- Develop application-specific I/O with FlexRIO Module Development Kit



Recommended software (sold separately):

 LabVIEW

 InstrumentStudio Professional

Additional resources for software development:

C/C++, C#, Python

 InstrumentStudio

 LabWindows/CVI

PXI Oscilloscopes

- Sample at speeds up to 5 GS/s
- 1.5 GHz of analog bandwidth
- Numerous triggering modes
- Up to 24-bit resolution

Key Features:

Deep Onboard Memory

PXI oscilloscopes feature deep onboard memory capable of storing multiple acquisitions from single channels or parallel acquisitions from multiple channels on the same device.

CableSense™ Technology

CableSense technology can reduce risk of faulty electrical connection by detecting changes from a known, golden setup without having to alter the connections themselves.

Automatic Synchronization

The same model scopes will synchronize in a PXI chassis for high-channel scope applications.

PXI Oscilloscope Modules

Selection Guide	Model	Part Number	Resolution	Bandwidth	Sample Rate	Channels	Memory Size	CableSense	Reconfigurable FPGA
High Performance	PXIe-5160	782621-01	10 Bits	500 MHz	2.5 GS/s	2	64 MB	—	—
		782621-02				2	2 GB	—	—
		782621-03				4	2 GB	—	—
		782621-11				2	64 MB	✓	—
		782621-12				2	2 GB	✓	—
		782621-13				4	2 GB	✓	—
High Performance, High Bandwidth	PXIe-5162	782622-01	10 Bits	1.5 GHz	5 GS/s	2	64 MB	—	—
		782622-05				2	2 GB	—	—
		782622-06				4	2 GB	—	—
		782622-11				2	64 MB	✓	—
		782622-15				2	2 GB	✓	—
		782622-16				4	2 GB	✓	—
High Density with Reconfigurable FPGA	PXIe-5172	784224-01	14 Bits	100 MHz	250 MS/s	4	0.75 GB	—	Kintex-7 325T
		784225-01				8	1.5 GB	—	
		784226-01				8	1.5 GB	—	Kintex-7 410T
High Density, Low Voltage Input with Reconfigurable FPGA	PXIe-5170	783690-01	14 Bits	100 MHz	250 MS/s	4	0.75 GB	—	Kintex-7 325T
		783691-01				8	1.5 GB	—	
	PXIe-5171	783692-01	14 Bits	250 MHz	250 MS/s	8	1.5 GB	—	Kintex-7 410T
High Density, Low Cost	PXIe-5105	783590-01	12 Bits	60 MHz	60 MS/s	8	16 MB	—	—
		783590-02					128 MB	—	—
		783590-03					512 MB	—	—
Low Cost	PXIe-5114	783591-01	8 Bits	125 MHz	250 MS/s	2	8 MB	—	—
		783591-02					64 MB/ch	—	—
		783591-03					256 MB/ch	—	—
Low Cost, Lowest Bandwidth	PXIe-5110	785767-01	8 Bits	100 MHz	1 GS/s	2	64 MB	—	—
		785768-01					512 MB	—	—
		785768-11					512 MB	✓	—
Low Cost, Medium Bandwidth	PXIe-5111	785769-01	8 Bits	350 MHz	3 GS/s	2	64 MB	—	—
		785769-11					64 MB	✓	—
		785770-01					512 MB	—	—
		785770-11					512 MB	✓	—
Low Cost, Highest Bandwidth	PXIe-5113	786375-01	8 Bits	500 MHz	3 GS/s	2	64 MB	—	—
		786375-11					64 MB	✓	—
		786405-01					512 MB	—	—
		786405-11					512 MB	✓	—
High-Voltage Input	PXIe-5163	785182-01	14 Bits	200 MHz	1 GS/s	2	512 MB	—	—
High Resolution	PXIe-5122	779967-01	14 Bits	100 MHz	100 MS/s	2	8 MB/ch	—	—
		779967-02					64 MB/ch	—	—
		779967-03					256 MB/ch	—	—
Flexible Resolution	PXI-5922	779153-01	24 Bits	6 MHz	15 MS/s	2	8 MB/ch	—	—
		779153-02					32 MB/ch	—	—
		779153-03					256 MB/ch	—	—
Highest Voltage Input	PXIe-5164	784183-01	14 Bits	400 MHz	1 GS/s	2	1.5 GB	—	Kintex-7 410T

PXI Oscilloscope Accessories

Single-Ended Passive Probes

Single-Ended Passive Probes	SP500X Single-Ended Passive Probe, 500 MHz, 300 VDC, 10:1 Attenuation	SP500C Single-Ended Passive Probe, 500 MHz, 300 VDC, 100:1 Attenuation	CP500X Single-Ended Coaxial Passive Probe, 500 MHz, 60 VDC, 10:1 Attenuation	CP400X Single-Ended Coaxial Passive Probe, 400 MHz, 60 VDC, 10:1 Attenuation
Part Number	783629-01	783630-01	784253-01	784254-01
PXIe-5105	—	—	—	—
PXIe-5110	✓	✓	✓	✓
PXIe-5111	✓	✓	✓	✓
PXIe-5113	✓	✓	✓	✓
PXIe-5114	—	—	—	✓
PXIe-5122	—	—	—	✓
PXIe-5160	✓	✓	✓	✓
PXIe-5162	✓	✓	✓	✓
PXIe-5163	✓	✓	✓	✓
PXIe-5164	✓	✓	✓	✓
PXIe-5170	—	—	—	—
PXIe-5171	—	—	—	—
PXIe-5172	✓*	✓*	✓*	✓*
PXI-5922	—	—	—	—

*Requires SMB-to-BNC Adapter

Active Probes

Active Probes	SA1000X Single-Ended Active Probe, 1 GHz, 20 VDC, 10:1 Attenuation	SA1500X Single-Ended Active Probe, 1.5 GHz, 20 VDC, 10:1 Attenuation	SA2500X Single-Ended Active Oscilloscope Probe, 2.5 GHz
Part Number	784255-01	784256-01	784257-01
PXIe-5105	✓	✓	✓
PXIe-5110	✓	✓	✓
PXIe-5111	✓	✓	✓
PXIe-5113	✓	✓	✓
PXIe-5114	✓	✓	✓
PXIe-5122	✓	✓	✓
PXIe-5160	✓	✓	✓
PXIe-5162	✓	✓	✓
PXIe-5163	✓	✓	✓
PXIe-5164	✓	✓	✓
PXIe-5170	✓	✓	✓
PXIe-5171	✓	✓	✓
PXIe-5172	✓	✓	✓
PXI-5922	✓	✓	✓

Current Probes

Current Probes	CC0550X Hioki Current Probe, 5 Arms, 50 MHz	CC05120X Hioki Current Probe, 5 Arms, 120 MHz	CC3050X Hioki Current Probe, 30 Arms, 50 MHz	CC30100X Hioki Current Probe, 30 Arms, 100 MHz	CC15010X Hioki Current Probe, 150 A, 10 MHz	CC5002X Hioki Current Probe, 500 A, 2 MHz
Part Number	786846-01	786847-01	785561-01	785562-01	786849-01	786848-01
PXIe-5105	✓	✓	✓	✓	✓	✓
PXIe-5110	✓	✓	✓	✓	✓	✓
PXIe-5111	✓	✓	✓	✓	✓	✓
PXIe-5113	✓	✓	✓	✓	✓	✓
PXIe-5114	✓	✓	✓	✓	✓	✓
PXIe-5122	✓	✓	✓	✓	✓	✓
PXIe-5160	✓	✓	✓	✓	✓	✓
PXIe-5162	✓	✓	✓	✓	✓	✓
PXIe-5163	✓	✓	✓	✓	✓	✓
PXIe-5164	✓	✓	✓	✓	✓	✓
PXIe-5170	—	—	—	—	—	—
PXIe-5171	—	—	—	—	—	—
PXIe-5172	✓	✓	✓	✓	✓	✓
PXI-5922	✓	✓	✓	✓	✓	✓

Cables

Description	BNC TO BNC Cable, 50 Ω, 0.9 m	HD BNC Male to BNC Female Cable, 50 Ω, 20 cm	SMA Male Plug X SMA Male Plug (Maxi-Flex) 5 in.	Cable Assy, SMA to SMA, Coax, RG-402, 50 Ω, 1 m
Part Number	781887-01	787230-0R2	763443-01	763444-01
PXIe-5105	—	—	—	—
PXIe-5110	✓	✓	—	—
PXIe-5111	✓	✓	—	—
PXIe-5113	✓	✓	—	—
PXIe-5114	✓	✓	—	—
PXIe-5122	✓	✓	—	—
PXIe-5160	✓	✓	—	—
PXIe-5162	✓	✓	—	—
PXIe-5163	✓	✓	—	—
PXIe-5164	✓	✓	—	—
PXIe-5170	—	—	✓	✓
PXIe-5171	—	—	✓	✓
PXIe-5172	—	—	—	—
PXI-5922	✓	✓	—	—

Cables (continued)

Description	SMA Male to SMA Male Cable, 50 Ω , 38.1 cm	1-Pin BNC (Male or Female) to 1-Pin SMB Female, 50 Ω Coaxial Cable	1-Pin SMB (Female) to 1-Pin BNC (Male or Female), 50 Ω Coaxial Cable, 2 ft.	1-Pin SMB (Female) to 1-Pin BNC (Male or Female), 50 Ω Coaxial Cable, 1 m
Part Number	781845-01	189425-0R6	763389-01	763405-01
PXIe-5105	—	—	—	—
PXIe-5110	—	—	✓	✓
PXIe-5111	—	—	✓	✓
PXIe-5113	—	—	✓	✓
PXIe-5114	—	—	✓	✓
PXIe-5122	—	—	✓	✓
PXIe-5160	—	—	✓	✓
PXIe-5162	—	—	✓	✓
PXIe-5163	—	—	✓	✓
PXIe-5164	—	—	✓	✓
PXIe-5170	✓	✓	—	—
PXIe-5171	✓	✓	—	—
PXIe-5172	—	—	✓	✓
PXI-5922	—	—	✓	✓

Probe Compensation Tabs



Probe Compensation Tabs	SMB Female to Probe Compensation Tabs, 8 cm
Part Number	786983-01
PXIe-5105	✓
PXIe-5110	—
PXIe-5111	—
PXIe-5113	—
PXIe-5114	—
PXIe-5122	—
PXIe-5160	✓
PXIe-5162	✓
PXIe-5163	—
PXIe-5164	—
PXIe-5170	—
PXIe-5171	—
PXIe-5172	—
PXI-5922	—



Recommended software (sold separately):

-  LabVIEW
-  InstrumentStudio Professional

Additional resources for software development:

- C/C++, C#, Python
-  InstrumentStudio
-  LabWindows/CVI

PXI Digital Multimeters

- Voltage measurements up to 1,000 VDC
- Current measurements up to 3 A
- Resistance measurements up to 5 GΩ
- Isolated digitizer mode up to 1.8 MS/s

Key Features:

Most Accurate 7.5-Digit DMM

With 26 bits of resolution and high stability, NI digital multimeters (DMMs) outperform traditional box DMMs.

Customizable Settings

With NI DMMs, you programmatically can customize measurement settings to prioritize speed or accuracy.

Isolated Digitizer Mode

Isolated, high-voltage digitizer mode means sample rates up to 1.8 MS/s—36X faster than traditional DMMs.

PXI Digital Multimeter Modules

Selection Guide	Model	Part Number	Basic DC Voltage Accuracy	Bus Connector	DC Current Range	DC Voltage Range	Digits of Resolution	L&C Measurements	Max Sample Rate
LCR Meter Functionality	PXIe-4082	783131-01	25 ppm	PXI Express	-1 A to 1 A	-300 V to 300 V	6.5	✓	1.8 MS/s
Highest Resolution and Voltage Range	PXIe-4081	783130-01	12 ppm	PXI Express	-3 A to 3 A	-1000 V to 1000 V	7.5	—	1.8 MS/s
General Purpose	PXIe-4080	783129-01	25 ppm	PXI Express	-1 A to 1 A	-300 V to 300 V	6.5	—	1.8 MS/s
Lowest Cost	PXI-4065	780011-01	90 ppm	PXI Hybrid	-3 A to 3 A	-300 V to 300 V	6.5	—	3 kS/s

PXI Digital Multimeter Accessories

Probes

Probe	P-1 DMM Test Probes	P-2 Probe Set	P-3 Probe Set, Banana Plug to Bare Wire DMM Cable, 1 m	Low-Leakage, Low-Thermal-EMF Cable Set (60 V Max)	Low-Leakage, Low-Thermal-EMF Connectivity Kit for Custom Cables (60 V Max)	Digital Multimeter Trigger Cable, 9-Pin DIN to 2 BNC, 0.5 m
Part Number	761000-01	184698-01	185692-01	779410-01	779499-01	184931-0R5
PXIe-4082	✓	✓	✓	✓	✓	—
PXIe-4081	✓	✓	✓	✓	✓	—
PXIe-4080	✓	✓	✓	✓	✓	—
PXI-4065	✓	✓	✓	✓	✓	✓

Connector Blocks



Connector Block	200 mA Current Shunt	10 A Current Shunt
Part Number	777488-01	777488-02
PXIe-4082	✓	✓
PXIe-4081	✓	✓
PXIe-4080	✓	✓
PXI-4065	✓	✓



Recommended software (sold separately):

-  LabVIEW
-  InstrumentStudio Professional

Additional resources for software development:

- C/C++, C#, Python
-  InstrumentStudio
-  LabWindows/CVI

PXI Waveform Generators

- Up to two 16-bit channels
- 800 MS/s update rate with 20, 40, and 80 MHz bandwidth options
- Up to 34 channels in parallel per chassis
- Maximum ± 12 V and minimum ± 7.75 mV output ranges

Key Features:

Waveform Streaming

A PXI waveform generator can stream hundreds of megasamples per second to instrument memory.

Digital Filtering

PXI waveform generators feature digital filtering designed to remove unwanted frequency images from the generated signal in arbitrary generation mode.

Waveform Scripting

Define standard and arbitrary waveforms that can be looped and burst using scripts.

PXI Waveform Generator Modules

Selection Guide	Model	Part Number	Resolution	Bandwidth	Upload Rate	Memory Size	Channels
Lowest Bandwidth	PXIe-5413	784181-01	16	20 MHz	800 MS/s	512 MB	1
		785114-01				1 GB	2
Medium Bandwidth	PXIe-5423	785115-01	16	40 MHz	800 MS/s	512 MB	1
		785116-01				1 GB	2
Highest Bandwidth	PXIe-5433	785117-01	16	80 MHz	800 MS/s	512 MB	1
		785118-01				1 GB	2
Clock Generator	PXI-5404	778577-02	12	100 MHz	300 MS/s	8 MB	1

PXI Waveform Generator Accessories

Cables

Description	Double-Shielded SMB to BNC Male Coax Cable, 50 Ω , 1 m	SMB Plug to SMB Plug Coax Cable, 50 Ω , 1 m, Qty 1	SMB Female to BNC Male Coax Cable, 1 m, Qty 1	SMA Male to SMA Male Cable, 50 Ω , 1 m	SMA Male to SMA Male Cable, 50 Ω , 30 cm	SMA Male to SMA Male Cable, 50 Ω , 38.1 cm
Part Number	778827-01	188859-01	763405-01	781845-01	781846-01	763444-01
PXIe-5413	—	—	—	✓	✓	✓
PXIe-5423	—	—	—	✓	✓	✓
PXIe-5433	—	—	—	✓	✓	✓
PXI-5404	✓	✓	✓	—	—	—



Recommended software (sold separately):

 LabVIEW

Additional resources for software development:

C/C++, C#, Python,

 LabWindows/CVI

PXI Counter/Timers

- Up to eight 32-bit counter/timers
- Up to 80 MHz measure frequency
- TTL/CMOS-compatible digital I/O
- Onboard high-precision oscillators

Key Features:

Multiple Counter/Timers:

These devices feature up to eight 32-bit counter/timers. These modules are suitable for a wide array of applications such as automotive/aerospace, industrial/motion control, and manufacturing test.

Versatile Measurement and Generation Capabilities:

PXI counter/timer modules perform encoder position measurement, event counting, period measurement, pulse-width measurement, pulse generation, pulse-train generation, and frequency measurement.

High Precision and Accuracy:

The PXIe-6614 has an onboard high-precision oscillator for highly accurate and precise measurement over longer periods of time because of the oven-controlled crystal oscillator (OCXO).

PXI Counter/Timer Modules

Category	Model	Part Number	Counters/Timers	Measure Frequency	Onboard High-Precision Oscillator
High-Voltage Option	PXI-6624	778975-01	8	400 MHz	—
Lowest Cost	PXIe-6612	782352-01	8	80 MHz	—
Onboard High-Precision Oscillator	PXIe-6614	782353-01	8	80 MHz	✓

PXI Counter/Timer Accessories

Connector Block

Connector Block	BNC-2121	CB-68LP Connector Block	CB-68LPR I/O Connector Block	SCB-68A Shielded Connector Block	TBX-68 Connector Block	SCB-100A Noise-Rejecting, Shielded I/O Connector Block	CB-100 I/O Kit, DIN Rail/Panel/Desktop, 50-Pin Connector Blocks, R1005050 Cable, 1 m
Part Number	778289-01	777145-01	777145-02	782536-01	777141-01	785024-01	777812-01
PXIe-6612	✓	✓	✓	✓	✓	—	—
PXIe-6614	✓	✓	✓	✓	✓	—	—
PXI-6624	—	—	—	—	—	✓	✓

Cables

Cables	Cable Assembly, 2 X 100-Pos .050 Series D-Type, Shielded, Flex Motion, Type SH100M-100M Flex, 1 m	Cable Assembly, 2 X 100-Pos .050 Series D-Type, Shielded, Flex Motion, Type Sh100M-100M Flex, 2 m (4150-0008)	Cable Assembly Kit, 68-68, SCSI-II, IDC, Type R6868	R6868 Low-Cost Unshielded Ribbon Cable, 0.25 m
Part Number	185095-01	185095-02	182482-01	182482-0R25
PXIe-6612	—	—	✓	✓
PXIe-6614	—	—	✓	✓
PXI-6624	✓	✓	—	—

Cables (continued)



Cables	SH68-68-D1 Shielded Cable, 2 m	SH68-68-D1 Shielded Cable, 5 m	SH68-68-D1 Shielded Cable, 0.4 m	Cable Assy, Type SH6868-D1, 10 m	Cable Assy, Type SH6868-D1, 1 m
Part Number	183432-02	183432-05	183432-0R4	183432-10	183432-01
PXIe-6612	✓	✓	✓	✓	✓
PXIe-6614	✓	✓	✓	✓	✓
PXI-6624	—	—	—	—	—



Recommended software (sold separately):

-  LabVIEW
-  InstrumentStudio Professional

Additional resources for software development:

- C/C++, C#, Python
-  InstrumentStudio
-  LabWindows/CVI

PXI Power Supplies

- Ability to source up to 300 W of DC power
- Voltage and current measurements with sample rates up to 1.8 MS/s and update rates up to 100 kS/s
- 4-wire remote-sense hardware timing and triggering

Key Features:

Source and Measure Faster

You can power your device under test with up to 300 W of DC power, all while taking current and voltage measurements up to 1.8 MS/s to capture the dynamic signal performance. Additionally, high-speed data converters offer update rates up to 100 kS/s for creating dynamic sequences.

Increase Measurement Accuracy

You can use multiple measurement ranges in certain PXI power supplies for both voltage and current to enhance measurement accuracy and reduce quantization noise. With this feature, you can achieve higher accuracy for both large and small signals, surpassing what you could do with one range.

Tune the Transient Response

You can use NI SourceAdapt technology to optimize system stability and minimize transient response times for a given load with your PXI programmable power supply. With NI SourceAdapt technology, you can test faster without potentially damaging your device.

PXI Power Supply Modules

Selection Guide	Model	Part Number	Channels	Maximum Voltage (V)	Maximum Current (A)	Maximum Power Per Channel (W)	Maximum Voltage Measurement Resolution	Maximum Current Measurement Resolution	SourceAdapt	Auxiliary Power Supply
Most Channels	PXI-4110	779647-11	3	±20	1	20	0.06 mV	0.20 µA	—	Included with Kit
Highest Voltage	PXIe-4112	782857-01	2	+60	1	60	17 mV	274 µA	—	Included with Kit
General Purpose	PXIe-4113	782857-02	2	+10	6	60	3 mV	2 mA	—	Included with Kit
High Power	PXIe-4151	788176-02	1	+20	25*	300	1 µV	10 nA	✓	Not Included
Highest Power	PXIe-4150	788176-01	1	+60	10*	300	1 µV	10 nA	✓	Not Included

*Requires a 58 W or greater chassis to source full-scale current

PXI Power Supply Accessories

Auxiliary Power Supplies and Cables

Auxiliary Power Supply or Cable	APS-4100 Auxiliary Power Source for NI DC Power Supplies*	Replacement Auxiliary Power Supply Module for NI PXIe-4112/13*	APS-4157, 48V Auxiliary Power Supply for NI PXIe-4150/1	APS-4158, 8-Channel Auxiliary Power Supply, 1,200 W, 48 V	APS-4159, 8-Channel Auxiliary Power Supply, 2,400 W, 48 V	Auxiliary Power Cable for APS-415x, 0.5 m	Auxiliary Power Cable for APS-415x, 1 m
Part Number	779671-01	782888-01	789776-01	788201-01	788201-02	788199-0R5	788199-01
PXI-4110	✓	—	—	—	—	—	—
PXIe-4112	—	✓	—	—	—	—	—
PXIe-4113	—	✓	—	—	—	—	—
PXIe-4151	—	—	✓	✓	✓	✓ **	✓ **
PXIe-4150	—	—	✓	✓	✓	✓**	✓**

*Replacement/extra

**Must purchase 1x auxiliary cable option per PXIe-4151 and PXIe-4150

Connectors and Connector Kits

Connectors and Connector Kits	Screw Terminal Connector Kit for PXI-4130 SMU***	Screw Terminal Connector Kit for PXIe-4112/3 Power Supplies***	Connector Kit for PXIe-4150/1 Power Supplies and PXIe-4051 Electronic Load***
Part Number	780557-01	782887-01	788197-01
PXI-4110	✓	—	—
PXIe-4112	—	✓	—
PXIe-4113	—	✓	—
PXIe-4151	—	—	✓
PXIe-4150	—	—	✓

***Replacement/extra

Mounting Kits

Mounting Kit	Rack-Mount Kit for APS-4158/9 Auxiliary Power Supplies
Part Number	786340-01
APS-4158	✓
APS-4159	✓

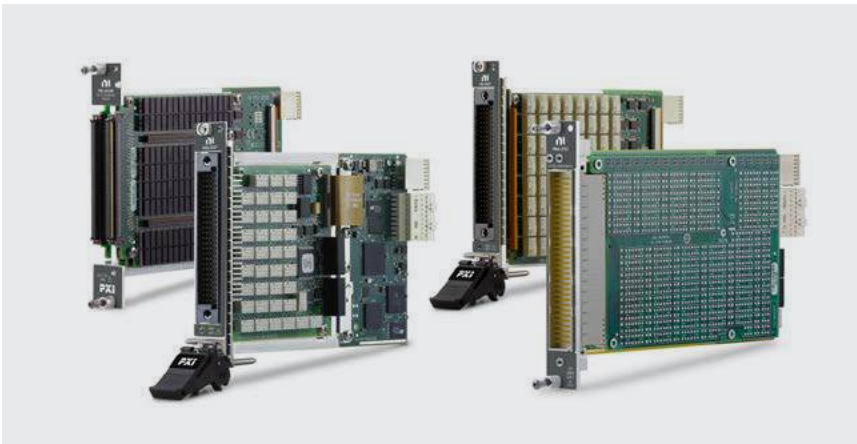

Recommended software (sold separately):

 LabVIEW

 Switch Executive

Additional resources for software development:

C/C++, C#, Python

 LabWindows/CVI

PXI Switches

- 100+ different switching topologies
- Up to 600 V and 40 A
- Bandwidth up to 40 GHz
- Up to 544 matrix crosspoints
- 1- wire, 2- wire, and 4-wire options
- Software selectable topologies offer flexibility

Key Features:

PXI Switch Expansion

Physically combine multiple PXI switches to create a single, larger switch by either joining the rows/columns of PXI matrices or by joining the COMs of PXI multiplexers.

Synchronize with Instruments

Perform hardware handshaking to synchronize a PXI switch with another PXI instrument, removing the software overhead and bus latency.

Switch Executive Software

Utilize this application software for intelligent switch management and routing that accelerates development and simplifies maintenance of complex switch systems.

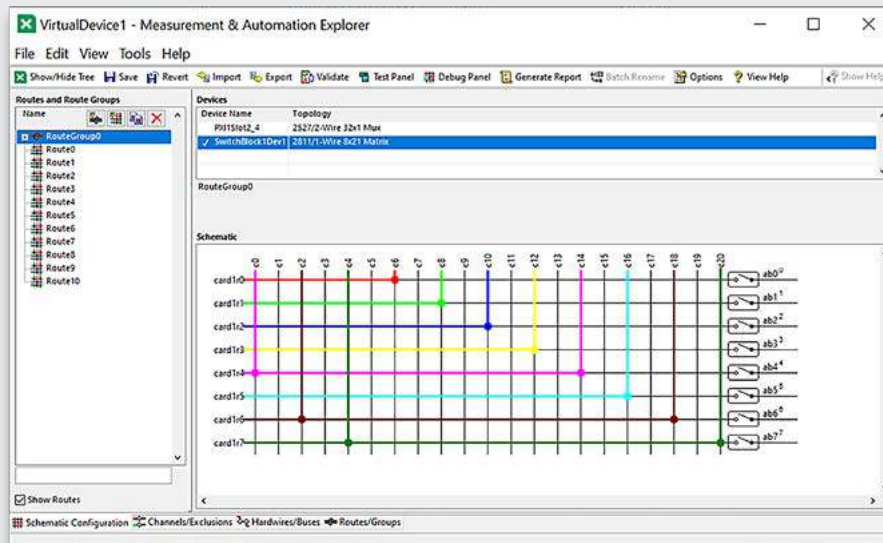

NI Switch Executive Software

While the NI-SWITCH driver provides all the low-level functionality required to program switch actions, Switch Executive is application software for intelligent switch management and routing that accelerates development and simplifies maintenance of complex switch systems. The point-and-click graphical configuration and automatic routing capabilities make it easy to design your switch system. Using intuitive channel aliases and route names keeps your system documented for future modifications. Save time and increase test code reuse by integrating your system with NI TestStand, LabVIEW, LabWindows/CVI, and NI Measurement Studio™ software.

With Switch Executive, you can:

- Graphically configure routes and route groups
- Develop reusable switching code and integrate it into NI TestStand or NI LabVIEW
- Automatically route signals between switch endpoints
- Scale switch configuration using Microsoft Excel
- Maintain switch configuration using route validation, reporting, and debugging features

PXI Switch Modules

General Purpose Switches

Selection Guide	Model	Part Number	Max Voltage (DC V)	Max Voltage (AC V)	Max Current (Switching)	Max Current (Carry)	Relay Type	Bandwidth	Topology
General-Purpose Switches	PXI-2522	778572-22	100	100	2	2	EMR	36 MHz	53-Channel, SPDT
	PXI-2568	778572-68	100	100	1	1	EMR	40 MHz	31-Channel, SPST
	PXI-2569	778572-69	100	100	1	1	EMR	40 MHz	100-Channel, SPST
	PXI-2571	778572-71	100	100	1	1	EMR	8 MHz	66-Channel, SPDT
	PXIe-2569	780587-69	100	100	1	1	EMR	8 MHz	100-Channel, SPST
	PXI-2564	778572-64	125	250	5	5	EMR	10 MHz	16-Channel, SPST
	PXI-2567	778572-67	150	150	2	2	—	20 MHz	64-Channel, Relay Driver
	PXI-2520	778572-20	150	150	2	2	EMR	51 MHz	80-Channel, SPST
	PXI-2566	778573-66	150	125	5	5	EMR	10 MHz	16-Channel, SPDT
	PXI-2586	778572-86	300	300	12	12	EMR	20 MHz	10-Channel, SPST

Matrix and Multiplexer Switches

Selection Guide	Model	Part Number	Max Voltage (DC V)	Max Voltage (AC V)	Max Current (Switching)	Max Current (Carry)	Relay Type	Bandwidth	Channels/Crosspoints
Matrix and Multiplexer Switches	PXI-2503	777697-01	60	30	1	1	EMR	10 MHz	48-channel Mux
	PXI-2530B	778572-30	60	30	0.4	0.4	Reed	3 MHz	128-channel Mux
	PXIe-2727	781986-27	60	30	0.3	0.3	EMR	—	32-channel Mux
	PXI-2532B	782383-01	100	100	0.5	0.5	Reed	25 MHz	512-Crosspoint Matrix
	PXIe-2529	780587-29	100	100	1	1	EMR	40 MHz	128-Crosspoint Matrix
	PXIe-2532B	782384-01	100	100	0.5	0.5	EMR	25 MHz	512-Crosspoint Matrix
	PXI-2575	778572-75	100	100	1	1	EMR	10 MHz	196-channel Mux
	PXIe-2575	780587-75	100	100	1	1	EMR	10 MHz	196-channel Mux
	PXIe-2737	782835-37	100	100	2	2	EMR	10 MHz	256-Crosspoint Matrix
	PXI-2576	778572-76	150	150	2	2	EMR	10 MHz	64-channel Mux
	PXIe-2525	780587-25	150	150	2	2	EMR	10 MHz	64-channel Mux
	PXIe-2527	780587-27	150	150	2	1	EMR	10 MHz	32-channel Mux

RF Switches

Selection Guide	Model	Part Number	Max Voltage (DC V)	Max Voltage (AC V)	Max Current (Switching)	Max Current (Carry)	Relay Type	Bandwidth	Topology
RF Switches	PXI-2547	778572-47	30	30	0.5	0.5	EMR	2.7 GHz	8x1 Mux
	PXI-2594	778572-94	30	30	0.5	0.5	EMR	2.5 GHz	4x1 Mux
	PXIe-2748	780587-48	30	30	0.5	0.5	EMR	3 GHz	Quad SPDT
	PXIe-2541	780587-41	60	42	0.5	0.5	Reed	300 MHz	8x12 Matrix
	PXI-2596	778572-96	—	90	—	1.73	EMR	26.5 GHz	Dual 6x1 Mux
	PXI-2599	778572-99	—	90	—	1.73	EMR	26.5 GHz	Dual SPDT
	PXIe-2593	780587-93	150	150	0.5	0.5	EMR	750 MHz	16x1 Mux

SwitchBlock Modules and Carrier Modules

Selection Guide	Model	Part Number	Max Voltage (DC V)	Max Voltage (AC V)	Max Current (Switching)	Max Current (Carry)	Relay Type	Bandwidth	Type A/B Module
SwitchBlock PXI Carrier Module	PXI-2800	781420-00	150	150	2	2	—	—	—
SwitchBlock Modules	SWB-2834	781420-34	100	0	2	2	EMR	10 MHz	Type A
	SWB-2834	781421-34	100	0	2	2	EMR	10 MHz	Type B
	SWB-2816	781420-16	100	70	0.25	0.3	Reed	8 MHz	Type A
	SWB-2816	781421-16	100	70	0.25	0.3	Reed	8 MHz	Type B
	SWB-2810	781420-10	150	0	1	1	Reed	10 MHz	Type A
	SWB-2810	781421-10	150	0	1	1	Reed	10 MHz	Type B

General-Purpose Switch Accessories

General-Purpose Switch Accessories

Description	160 Pin DIN to Bare Wire Cable for PXI Switches, 1 m	160 Pin DIN to 160 Pin DIN Cable for PXI Switches, 1 m	160 Pin DIN to 4 D-SUB Cable for PXI Switches, 1 m	NI TBX-50B, 50 Pin D-SUB Screw Terminal Block	Cable for PXI-2520 (160-Pin DIN to 160-Pin DIN)	Cable for PXI-2510 (160-Pin DIN to Bare Wire)
Part Number	782417-01	782417-02	782417-03	782866-01	781090-02	781090-03
PXI-2520	✓	✓	✓	✓	✓	✓
PXI-2522	✓	✓	✓	✓	✓	✓
PXI-2527	—	—	—	—	—	—
PXI-2529	—	—	—	—	—	—
PXI-2564	—	—	—	—	—	—
PXI-2566	—	—	—	—	—	—
PXI-2567	—	—	—	—	—	—
PXI-2568	—	—	—	—	—	—
PXI-2569	—	—	—	—	—	—
PXI-2571	—	—	—	—	—	—
PXI-2586	✓	✓	—	—	—	—
PXI-2576	—	—	—	—	—	—
PXIe-2525	✓	✓	✓	✓	✓	✓
PXIe-2527	—	—	—	—	—	—
PXIe-2529	—	—	—	—	—	—
PXIe-2569	—	—	—	—	—	—

General-Purpose Switch Accessories (continued)

Description	Relay Replacement Kit for IM42GR Relays (Qty: 10)	NI TB-2636 Terminal Block for NI PXI-2529 4 X 32 (2-Wire) Matrix	NI TB-2635, Terminal Block for NI PXI-2529 as 8X16 Matrix	NI TB-2634, Terminal Block for NI PXI-2529 as 4X32 Matrix	37-Pin Female-to-Female D-SUB Cable for NI PXI-2564 1 m	D-SUB, 62/57Pos, Backshell and Connector Kit
Part Number	779356-01	196762-01	778839-01	778840-01	779955-01	778720-01
PXI-2520	—	—	—	—	—	—
PXI-2522	—	—	—	—	—	—
PXI-2527	✓	—	—	—	—	—
PXI-2529	—	✓	✓	✓	—	—
PXI-2564	—	—	—	—	✓	—
PXI-2566	—	—	—	—	—	✓
PXI-2567	—	—	—	—	—	—
PXI-2568	—	—	—	—	—	—
PXI-2569	—	—	—	—	—	—
PXI-2571	—	—	—	—	—	—
PXI-2586	—	—	—	—	—	—
PXI-2576	—	—	—	—	—	—
PXIe-2525	—	—	—	—	—	—
PXIe-2527	✓	—	—	—	—	—
PXIe-2529	—	✓	✓	✓	—	—
PXIe-2569	—	—	—	—	—	—

General-Purpose Switch Accessories (continued)

Description	62-Pin Female-to-Female Shielded D-SUB Cable for NI PXI-2568	NI TBX-62 62-Pin D-SUB Screw Terminal Block	NI TB-2666 Terminal Block	LFH200 to 4X50-Pin D-SUB Switch Cable (Ch-Ch Twisted), 60 VDC, 1 m	LFH200 to 4X50-Pin D-SUB Switch Cable (Ch-Com Twisted), 60 VDC, 2 m	NI TBX-50, 50 Pin D-SUB Screw Terminal Block
Part Number	779956-01	779957-01	778717-66	779038-03	783139-02	779305-01
PXI-2520	—	—	—	—	—	—
PXI-2522	—	—	—	—	—	—
PXI-2527	—	—	—	—	—	—
PXI-2529	—	—	—	—	—	—
PXI-2564	—	—	—	—	—	—
PXI-2566	—	—	—	—	—	—
PXI-2567	—	—	—	—	—	—
PXI-2568	✓	✓	—	—	—	—
PXI-2569	—	—	✓	✓	✓	—
PXI-2571	—	—	—	✓	✓	—
PXI-2586	—	—	—	—	—	—
PXI-2576	—	—	—	—	—	✓
PXIe-2525	—	—	—	—	—	—
PXIe-2527	—	—	—	—	—	—
PXIe-2529	—	—	—	—	—	—
PXIe-2569	—	—	✓	✓	✓	—

General-Purpose Switch Accessories (continued)

Description	NI TB-2676 Terminal Block for NI PXI-2576	Ribbon Cable Kit for NI TB-2676 Terminal Block	LFH160 to 50-Pin D-SUB	Cable for NI PXI-2585 and NI PXI-2586 (GMCT20-GMCT20)	Cable for NI PXI-2585 and NI PXI-2586 (GMCT20-Bare Wire)
Part Number	779535-01	779669-01	780009-01	781256-01	781257-01
PXI-2520	—	—	—	—	—
PXI-2522	—	—	—	—	—
PXI-2527	—	—	—	—	—
PXI-2529	—	—	—	—	—
PXI-2564	—	—	—	—	—
PXI-2566	—	—	—	—	—
PXI-2567	—	—	—	—	—
PXI-2568	—	—	—	—	—
PXI-2569	—	—	—	—	—
PXI-2571	—	—	—	—	—
PXI-2586	—	—	—	✓	✓
PXI-2576	✓	✓	✓	—	—
PXIe-2525	—	—	—	—	—
PXIe-2527	—	—	—	—	—
PXIe-2529	—	—	—	—	—
PXIe-2569	—	—	—	—	—

Matrix Switches

Matrix Switch Accessories

Description	NI TB-2630B, Terminal Block for NI PXI-2530B as Multiplexer	NI TB-2631B, Term Block for NI PXI-2530B, 4X32 1W or 4X16 2W Matrix	NI TB-2632B, Terminal Block for NI PXI-2530B as 8X16 1W Matrix	LFH160 to 50-Pin D-SUB for NI PXI-2530B	Cable for PXI-2510 (160-Pin DIN to 160-Pin DIN)	Cable for PXI-2510 (160-Pin DIN to Bare Wire)
Part Number	781687-01	781688-01	781689-01	781692-01	781090-02	781090-03
PXI-2503	—	—	—	—	—	—
PXI-2530B	✓	✓	✓	✓	—	—
PXI-2532B	—	—	—	—	—	—
PXIe-2529	—	—	—	—	—	—
PXIe-2737	—	—	—	—	✓	✓
PXIe-2530B	✓	✓	✓	✓	—	—
PXIe-2532B	—	—	—	—	—	—

Matrix Switch Accessories (continued)

Description	160 Pin DIN to Bare Wire Cable for PXI Switches, 1 m	160 Pin DIN to 160 Pin DIN Cable for PXI Switches, 1 m	160 Pin DIN to 4 D-SUB Cable for PXI Switches, 1 m	NI TB-2636 Terminal Block for NI PXI-2529 4 X 32 (2-Wire) Matrix	NI TB-2635, Terminal Block for NI PXI-2529 as 8X16 Matrix	NI TB-2634, Terminal Block for NI PXI-2529 as 4X32 Matrix
Part Number	782417-01	782417-02	782417-03	196762-01	778839-01	778840-01
PXI-2503	—	—	—	—	—	—
PXI-2530B	—	—	—	—	—	—
PXI-2532B	—	—	—	—	—	—
PXIe-2529	—	—	—	✓	✓	✓
PXIe-2737	✓	✓	✓	—	—	—
PXIe-2530B	—	—	—	—	—	—
PXIe-2532B	—	—	—	—	—	—

Matrix Switch Accessories (continued)

Description	Matrix Terminal Block and Analog Bus Plug Kit	2 X 68-Pos .050 Series D-Type Shielded, Type SH68-68-S, 1 m	2 X 68-Pos .050 Series D-Type Shielded, Type SH68-68-S, 2 m	2 X 68-Pos .050 Series D-Type Shielded, Type SH68-68-S, 5 m	2 X 68-Pos .050 Series D-Type Shielded, Type SH68-68-S, 0.5 m	TB Extension-Low Voltage General 24-Ch with CJC
Part Number	777879-01	185262-01	185262-02	185262-05	786762-01	777716-01
PXI-2503	✓	✓	✓	✓	✓	✓
PXI-2530B	—	—	—	—	—	—
PXI-2532B	—	—	—	—	—	—
PXIe-2529	—	—	—	—	—	—
PXIe-2737	—	—	—	—	—	—
PXIe-2530B	—	—	—	—	—	—
PXIe-2532B	—	—	—	—	—	—

Matrix Switch Accessories (continued)

Description	TBX-68 Connector Block	50 Pin D-SUB Screw Terminal Block	Screw Terminal Block Accessory for TB-264XB (60 VDC)	Matrix Expansion Cable for TB-264XB Terminal Blocks (60 VDC, 9 in.)	Row and Column Cable Kit for TB-264XB Terminal Blocks (60 VDC, 1.5 m)	Row and Column Cable Kit for TB-264XB Terminal Blocks (100 VDC, 1.5 m)
Part Number	777141-01	782866-01	779341-01	779325-01	779346-01	782427-01
PXI-2503	✓	—	—	—	—	—
PXI-2530B	—	—	—	—	—	—
PXI-2532B	—	—	—	—	—	—
PXIe-2529	—	—	—	—	—	—
PXIe-2737	—	✓	—	—	—	—
PXIe-2530B	—	—	—	—	—	—
PXIe-2532B	—	—	✓	✓	✓	✓

Matrix Switch Accessories (continued)

Description	Terminal Block for NI2531 as 4 X 128 Matrix	NI TB-2649 Terminal Block for NI 2531 as Dual 4 X 64 Matrix	NI TB-2640B Terminal Block for NI 2532B as 4 X 128 Matrix	NI TB-2640B Terminal Block for NI 2532B as 4 X 128 Matrix W/100 Ω	NI TB-2641B Terminal Block for NI 2532B as 8 X 64 Matrix	NI TB-2641B Terminal Block for NI 2532B as 8 X 64 Matrix w/100 Ω
Part Number	781131-01	781131-02	782385-01	782385-02	782385-03	782385-04
PXI-2503	—	—	—	—	—	—
PXI-2530B	—	—	—	—	—	—
PXI-2532B	—	—	—	—	—	—
PXIe-2529	—	—	—	—	—	—
PXIe-2737	—	—	—	—	—	—
PXIe-2530B	—	—	—	—	—	—
PXIe-2532B	✓	✓	✓	✓	✓	✓

Matrix Switch Accessories (continued)

Description	NI TB-2642B Terminal Block for NI 2532B as 16 X 32 Matrix	NI TB-2642B Terminal Block for NI 2532B as 16 X 32 Matrix w/100 Ω	NI TB-2643B Terminal Block for NI 2532B as 4 X 64 Matrix	NI TB-2643B Terminal Block for NI 2532B as 4 X 64 Matrix W/100 Ω	NI TB-2644B Terminal Block for NI 2532B as 8 X 32 Matrix	NI TB-2644B Terminal Block for NI 2532B as 8 X 32 Matrix W/100 Ω
Part Number	782385-05	782385-06	782385-07	782385-08	782385-09	782385-10
PXI-2503	—	—	—	—	—	—
PXI-2530B	—	—	—	—	—	—
PXI-2532B	—	—	—	—	—	—
PXIe-2529	—	—	—	—	—	—
PXIe-2737	—	—	—	—	—	—
PXIe-2530B	—	—	—	—	—	—
PXIe-2532B	✓	✓	✓	✓	✓	✓

Matrix Switch Accessories (continued)

Description	NI TB-2645B Terminal Block for NI 2532B as 16 X 16 Matrix	NI TB-2645B Terminal Block for NI 2532B as 16 X 16 Matrix W/100 Ω	NI TB-2646B Terminal Block for NI 2532B as 4 X 32 Matrix	NI TB-2646B Terminal Block for NI 2532B as 4 X 32 Matrix W/100 Ω	Matrix Expansion Cable for TB-264XB Terminal Blocks (100 VDC, 9 in.)
Part Number	782385-11	782385-12	782385-13	782385-14	782426-01
PXI-2503	—	—	—	—	—
PXI-2530B	—	—	—	—	—
PXI-2532B	—	—	—	—	—
PXIe-2529	—	—	—	—	—
PXIe-2737	—	—	—	—	—
PXIe-2530B	—	—	—	—	—
PXIe-2532B	✓	✓	✓	✓	✓

Multiplexer Switches

Multiplexer Switch Accessories (continued)

Description	NI TBX-50, 50 Pin D-SUB Screw Terminal Block	NI TB-2676 Terminal Block for NI PXI-2576	Ribbon Cable Kit for NI TB-2676 Terminal Block	LFH160 to 50-Pin D-SUB	160 Pin DIN to Bare Wire Cable for PXI Switches, 1 m	160 Pin DIN to 160 Pin DIN Cable for PXI Switches, 1 m	160 Pin DIN to 4 D-SUB Cable for PXI Switches, 1 m
Part Number	779305-01	779535-01	779669-01	780009-01	782417-01	782417-02	782417-03
PXI-2575	✓	—	—	✓	—	—	—
PXI-2576	✓	✓	✓	✓	—	—	—
PXIe-2525	✓	—	—	—	✓	✓	✓
PXIe-2527	—	—	—	—	—	—	—
PXIe-2575	✓	—	—	✓	—	—	—

Multiplexer Switch Accessories (continued)

Description	NI TBX-50B, 50 Pin D-SUB Screw Terminal Block	Cable for PXI-2520 (160-Pin DIN to 160-Pin DIN)	160-Pin DIN to Bare Wire	Relay Replacement Kit for IM42GR Relays (Qty: 10)	SH37F-37M-1 37-Pin Female to Male Shielded I/O Cable, 1 m	SH37F-37M-2 37-Pin Female to Male Shielded I/O Cable, 2 m	MCX Plug to MCX Plug, 0.15 m
Part Number	782866-01	781090-02	781090-03	779356-01	778621-01	778621-02	188374-0R15
PXI-2575	✓	—	—	—	—	—	—
PXI-2576	✓	—	—	—	—	—	—
PXIe-2525	✓	✓	✓	—	—	—	—
PXIe-2527	—	—	—	✓	—	—	—
PXIe-2575	✓	—	—	—	—	—	—

Multiplexer Switch Accessories (continued)

Description	LFH200 Connector to Bare Wire Switch Cable, 60 VDC, 2 m	LFH200 to 4X50-Pin D-SUB Switch Cable (Ch-Com Twisted), 60 VDC, 1 m	LFH200 to 4X50-Pin D-SUB Switch Cable (Ch-Ch Twisted), 60 VDC, 1 m	LFH200 to 4X50-Pin D-SUB Switch Cable (Ch-Com Twisted), 60 VDC, 2 m	Terminal Block for NI PXI-2527
Part Number	779038-01	779038-02	779038-03	783139-02	779358-01
PXI-2575	✓	✓	✓	✓	—
PXI-2576	—	—	—	—	—
PXIe-2525	—	—	—	—	—
PXIe-2527	—	—	—	—	✓
PXIe-2575	✓	✓	✓	✓	—

RF Switches

RF Switch Accessories

Description	MCX Plug to MCX Plug, 0.15 m	MCX Plug to BNC Plug, 1 m	MCX Plug to BNC Plug, 0.3 m	MCX Male to SMB Female Cable, 50 Ω , 30 cm	MCX Male to SMB Female Cable, 50 Ω , 1 m	MCX Male to SMA Male Cable, 50 Ω , 1 m	MCX Male to MCX Male Cable, 50 Ω , 1 m	MCX Male to MCX Male Cable, 50 Ω , 30 cm
Part Number	188374-OR15	188375-01	188375-OR3	188376-OR3	188376-01	188377-01	188374-01	188374-OR3
PXI-2546	—	—	—	—	—	✓	—	—
PXI-2548	—	—	—	—	—	✓	—	—
PXIe-2543	—	—	—	—	—	✓	—	—
PXIe-2544	—	—	—	—	—	✓	—	—
PXIe-2746	✓	✓	✓	✓	✓	✓	✓	✓

RF Switch Accessories (continued)

Description	MCX Male to SMA Male Cable, 50 Ω , 30 cm	MCX Male to BNC Male Cable, 50 Ω , 1 m	MCX Male to BNC Male Cable, 50 Ω , 30 cm	MCX Male to MCX Male Cable, 50 Ω , 15 cm	SMA Male to SMA Male Cable, 50 Ω , 38.1 cm	SMA Male to SMA Male Cable, 50 Ω , 12.7 cm	SMA Male to SMA Male Cable for USRP, 50 Ω , 2 m	SMA Male to SMA Male Cable, 50 Ω , 30 cm
Part Number	188377-OR3	188375-01	188375-OR3	188374-OR15	763444-01	763443-01	783470-01	781846-01
PXI-2546	—	—	—	—	✓	✓	✓	✓
PXI-2548	—	—	—	—	✓	✓	✓	✓
PXIe-2543	✓	—	—	—	—	—	—	—
PXIe-2544	✓	—	—	—	—	—	—	—
PXIe-2746	✓	✓	✓	✓	—	—	—	—

SwitchBlock

SwitchBlock Accessories

Description	SH96F-96M Cable for NI SwitchBlock, 1 m	SH96F-96M Cable for NI SwitchBlock, 0.5 m	SH96F-96M Cable for NI SwitchBlock, 1.5 m	SH96F-96M-Res Cable for NI SwitchBlock (100 Ω Protection), 1 m	SH96F-96M-42V Shielded Cable for PXIe-4304/5 to Rack-Mount Terminal Block, 1 m
Part Number	150275-01	150275-OR5	150275-1R5	150579-01	158228-01
SWB-2810	✓	✓	✓	✓	✓
SWB-2816	✓	✓	✓	✓	✓
SWB-2834	✓	✓	✓	✓	✓

SwitchBlock Accessories



Description	SH96F-96M-42V Shielded Cable for PXIe-4304/5 to Rack-Mount Terminal Block, 3 m	SH96F-96M-42V Shielded Cable for PXIe-4304/5 to Rack-Mount Terminal Block, 5 m	SH96F-96M-Cal4330, Shielded Cable for PXIe-4330 and PXIe-4331 to CAL-4330, 1 m	96-Pin Screw Terminal Accessory for NI SwitchBlock
Part Number	158228-03	158228-05	787003-01	781420-09
SWB-2810	✓	✓	✓	✓
SWB-2816	✓	✓	✓	✓
SWB-2834	✓	✓	✓	✓



Recommended software (sold separately):

-  LabVIEW
-  InstrumentStudio Professional

Additional resources for software development:

- C/C++, C#, Python
-  InstrumentStudio
-  LabWindows/CVI

PXI Source Measure Units

- Up to 24 channels (408 per chassis)
- Up to 200 V and 3 A (10 A pulse)
- Current sensitivity down to 10 fA
- Max power per channel of 40 W (500 W pulse)

Key Features:

Unmatched Channel Density

Reduce test time, increase throughput, and meet today's manufacturing requirements by reducing a full rack to a few inches of physical space with up to 408 SMU channels in a single PXI chassis.

Built-In IV Sweep

Reconfigure and repurpose the same SMUs across test cases with configuration-based IV sweeps in InstrumentStudio software and a path to more advanced customization in programming environments.

High-Power Pulsing

Operate beyond the basic DC power boundary of PXI SMUs by pulsing current or voltage instead of supplying a constant DC source, allowing you to test at high instantaneous power with limited or no heat sink infrastructure.

PXI Source Measure Unit Modules

Selection Guide	Model	Part Number	Channel Count	Max Voltage	Max Current	Current Sensitivity	Max Source Power	Max Sink Power	Pulsing	Max Sample Rate	SourceAdapt
1-Channel Precision SMU, 20 W	PXIe-4135	783762-01	1	200 V	1 A	10 fA	20 W	20 W	✓	1.8 MS/s	✓
1-Channel Precision SMU, 40 W	PXIe-4135	783762-02	1	200 V	1 A	10 fA	40 W	40 W	✓	1.8 MS/s	✓
1-Channel Lower-Cost SMU, 20 W	PXIe-4136	783760-01	1	200 V	1 A	1 pA	20 W	20 W	—	1.8 MS/s	—
1-Channel Precision SMU, 20 W	PXIe-4137	783761-01	1	200 V	1 A	100 fA	20 W	20 W	✓	1.8 MS/s	✓
1-Channel Precision SMU, 40 W	PXIe-4137	783761-02	1	200 V	1 A	100 fA	40 W	40 W	✓	1.8 MS/s	✓
1-Channel Lower-Cost SMU, 20 W	PXIe-4138	782856-01	1	60 V	3 A	1 pA	20 W	20 W	—	1.8 MS/s	—
1-Channel Precision SMU, 20 W	PXIe-4139	782856-02	1	60 V	3 A	100 fA	20 W	20 W	✓	1.8 MS/s	✓
1-Channel Precision SMU, 40 W	PXIe-4139	782856-03	1	60 V	3 A	100 fA	40 W	40 W	✓	1.8 MS/s	✓
4-Channel Lower-Cost SMU	PXIe-4142	782430-01	4	24 V	150 mA	100 pA	3.6 W	3.6 W	—	600 kS/s	—
4-Channel Precision SMU	PXIe-4143	782431-01	4	24 V	150 mA	10 pA	3.6 W	3.6 W	—	600 kS/s	✓
4-Channel Lower-Cost SMU	PXIe-4144	782432-01	4	6 V	500 mA	150 pA	3 W	3 W	—	600 kS/s	—
4-Channel Precision SMU	PXIe-4145	782435-01	4	6 V	500 mA	15 pA	3 W	3 W	—	600 kS/s	✓
4-Channel Precision SMU	PXIe-4147	786888-01	4	6 V	3 A	100 fA	24 W	24 W	—	1.8 MS/s	✓
12-Channel High-Density SMU	PXIe-4162	785680-01	12	24 V	100 mA	100 pA	2.4 W	2.4 W	—	100 kS/s	✓
12-Channel High-Density Precision SMU	PXIe-4162	785680-02	12	24 V	100 mA	10 pA	2.4 W	2.4 W	—	100 kS/s	✓
24-Channel High-Density SMU	PXIe-4163	784483-01	24	24 V	50 mA	100 pA	1.2 W	1.2 W	—	100 kS/s	✓
24-Channel High-Density Precision SMU	PXIe-4163	784483-02	24	24 V	50 mA	10 pA	1.2 W	1.2 W	—	100 kS/s	✓
1-Channel 500 kHz Lower-Cost LCR Meter and SMU	PXIe-4190	788101-01	1	40 V	100 mA	1 pA	4 W	4 W	—	600 kS/s	✓
1-Channel 2 MHz LCR Meter and SMU	PXIe-4190	788088-01	1	10 V	100 mA	1 fA	1 W	1 W	—	600 kS/s	✓

PXI Source Measure Unit Accessories

Cables

Cables	TriaxM-TriaxM Low-Noise Triaxial-to-Triaxial Cable			Safety Interlock Cable PXIe-4135/6/7		SH8M-7F-LL Low-Leakage Cable	
	1 m	3 m	5 m	8 in.	48 in.	1 m	2 m
Part Number	785659-01	785659-03	788746-05	142998-08	142998-48	130123-01	130123-02
PXIe-4135	✓	✓	✓	✓	✓		
PXIe-4136	—	—	—	✓	✓	✓	✓
PXIe-4137	—	—	—	✓	✓	✓	✓
PXIe-4138	—	—	—	—	—	✓	✓
PXIe-4139	—	—	—	—	—	✓	✓
PXIe-4142	—	—	—	—	—	—	—
PXIe-4143	—	—	—	—	—	—	—
PXIe-4144	—	—	—	—	—	—	—
PXIe-4145	—	—	—	—	—	—	—
PXIe-4147	—	—	—	—	—	—	—
PXIe-4162	—	—	—	—	—	—	—
PXIe-4163	—	—	—	—	—	—	—

Cables (continued)

Cables	SHDB25F-DB25F Low-Leakage 25-Pin D-SUB Cable		SHDB62M-DB62M-LL Low-Leakage 62-Pin D-SUB Cable		SHDB62M-BW-LL Low-Leakage 62-Pin D-SUB to Bare Wire Cable	
	1 m	2 m	1 m	2 m	1 m	2 m
Part Number	132893-01	132893-02	142947-01	142947-02	142948-01	142948-02
PXIe-4135	—	—	—	—	—	—
PXIe-4136	—	—	—	—	—	—
PXIe-4137	—	—	—	—	—	—
PXIe-4138	—	—	—	—	—	—
PXIe-4139	—	—	—	—	—	—
PXIe-4142	✓	✓	—	—	—	—
PXIe-4143	✓	✓	—	—	—	—
PXIe-4144	✓	✓	—	—	—	—
PXIe-4145	✓	✓	—	—	—	—
PXIe-4147	✓	✓	—	—	—	—
PXIe-4162	—	—	✓	✓	✓	✓
PXIe-4163	—	—	✓	✓	✓	✓

Screw Terminal Connectors and Adapters

Screw Terminal Connectors and Adapters	SA-413B Banana Jack Adapter for PXIe-4136/7/8/9	SA-413T Triaxial Adapter for PXIe-4138/9	Additional or Replacement Connector Kit*					
			Part Number	786818-01	784000-01	784484-01	784068-01	787611-01
PXIe-4135	—	—	✓	—	—	—	—	—
PXIe-4136	✓	—	—	✓	—	—	—	—
PXIe-4137	✓	—	—	✓	—	—	—	—
PXIe-4138	✓	✓	—	✓	—	—	—	—
PXIe-4139	✓	✓	—	✓	—	—	—	—
PXIe-4142	—	—	—	—	✓	—	—	—
PXIe-4143	—	—	—	—	✓	—	—	—
PXIe-4144	—	—	—	—	✓	—	—	—
PXIe-4145	—	—	—	—	✓	—	—	—
PXIe-4147	—	—	—	—	✓	—	—	—
PXIe-4162	—	—	—	—	—	✓	—	—
PXIe-4163	—	—	—	—	—	—	—	✓

*Replacement/extra

Protection Accessories

Protection Accessories	Open-Sense Protection Accessory without Detection		Current and Open-Sense Protection Accessory with Detection**		Open-Sense Protection Accessory with Detection		
	Part Number	787719-01	787720-01	788403-01	788404-01	787719-02	787720-02
PXIe-4162	✓	—	✓	—	✓	—	—
PXIe-4163	—	✓	—	✓	—	✓	—

**Replacement/extra



Recommended software (sold separately):

 LabVIEW

 InstrumentStudio Professional

Additional resources for software development:

C/C++, C#, Python

 InstrumentStudio

 LabWindows/CVI

PXI LCR Meters and SMUs

- AC stimulus frequency up to 2 MHz
- AC stimulus amplitude up to 7.07 V_{rms}
- DC bias up to ± 40 V
- Basic impedance accuracy of 0.05 percent

Key Features:

High-Precision, High-Accuracy Measurements

NI LCR meters are built with a combination of off-the-shelf high-speed and high-precision data converter technology to provide low noise measurements across a wide range of LCR meter stimulus frequencies and SMU measurement speeds.

High-Speed Measurement and Update Rate

The NI PXIe-4190 provides flexible measurement time settings, including preset options (100 ms for slow, 10 ms for normal, and 1 ms for fast) and the ability to choose custom values outside of these three preset values.

SourceAdapt Digital Control Loop Technology

SourceAdapt is a digital control loop technology that gives you the ability to optimize the SMU response for any device under test (DUT). This provides fast and stable measurements for a variety of loads, even highly capacitive or inductive ones, and prevents damage to your DUT by removing harmful overshoots and oscillations.

PXI LCR Meter and SMU Modules

Selection Guide	Model	Part Number	Channel Count	Min AC Stimulus Frequency	Max AC Stimulus Frequency	Max AC Stimulus Voltage	Max AC Stimulus Current	Max DC Bias Voltage (DC + AC)	Max DC Bias Current (DC + AC)
1-Channel 500 kHz Lower-Cost LCR Meter and SMU	PXIe-4190	788101-01	1	40 Hz	500 kHz	7.07 V _{rms}	70.7 mA _{rms}	10 V	100 mA
1-Channel 2 MHz LCR Meter and SMU	PXIe-4190	788088-01			2 MHz			40 V	

PXI LCR Meter and SMU Accessories



Cable	SHDB13W6-4BNM-LL Low-Leakage D-SUB to Male BNC Cable			SHDB13W6-4BNCF-LL Low-Leakage D-SUB to Female BNC Cable			SHDB13W6-4TriaxM-LL Low-Leakage D-SUB to Male Triax Cable			SHDB13W6-DB13W6-LL Low-Leakage D-SUB to D-SUB Cable		
	1 m	2 m	4 m	0.5 m	1 m	2 m	1 m	2 m	4 m	1 m	2 m	4 m
Part Number	788280- 01	788280- 02	788280- 04	789536- 0R5	789536- 01	789536- 02	788281- 01	788281- 02	788281- 04	788279- 01	788279- 02	788279- 04
PXIe-4190	✓	✓	✓	✓	✓	✓	✓	✓	✓	✓	✓	✓



Recommended software (sold separately):

-  LabVIEW
-  Semiconductor Device Control Add-On for InstrumentStudio

Additional resources for software development:

- C/C++, C#, Python
-  Digital Pattern Editor
-  LabWindows/CVI

PXI Digital Pattern Instruments

- 32-channel module (up to 512 per chassis)
- 100 MHz vector rate, 39 ps displacement
- Digital voltage -of 2 V to 6 V
- Up to 200 Mb/s data rate

Key Features:

Dedicated Digital Pattern Editor

The Digital Pattern Editor is an interactive tool for importing, editing, or creating test patterns. The software integrates editing sheets for device pin maps, specifications, and patterns to develop or edit imported digital test vectors and patterns.

Debug Digital Test Patterns

The Digital Pattern Editor includes tools such as Shmoo plots to provide a deeper understanding of DUT performance across variation. The editor also offers debugging tools such as overlaying pattern failures on a pattern or using digital scope for an analog view of the pin data.

Programmatic Pattern Bursting

The NI-Digital Pattern Driver in LabVIEW, C, or .NET offers the ability to develop test code to interact with PXI digital pattern instruments.

PXI Digital Pattern Instrument Modules

Selection Guide	Model	Part Number	Active Load	Channels	Maximum Vector Rate	Maximum Data Rate	Maximum Clock Generation	Pattern Timing	Drive Formats	Timing Specifications
Higher Channel Count, Higher Active Load	PXIe-6570	785283-01	24 mA	32 per Module	100 MHz (10 ns Minimum Vector Period)	200 Mb/s	160 MHz*	31 Time Sets 39.0625 ps Edge-Placement Resolution	Nonreturn (NR), Return to Low (RL), Return to High (RH) (100 MHz max), Surround by Complement (SBC) (50 MHz max)	Warranted
Higher Channel Count	PXIe-6571	786320-01	16 mA	32 per Module						Warranted
General Purpose	PXIe-6571	786320-02	16 mA	8 per Module						Typical

*Clock rates >133 MHz will have a non-50% duty cycle.

**See [PXI Digital Waveform and Pattern Instrument Accessories](#)

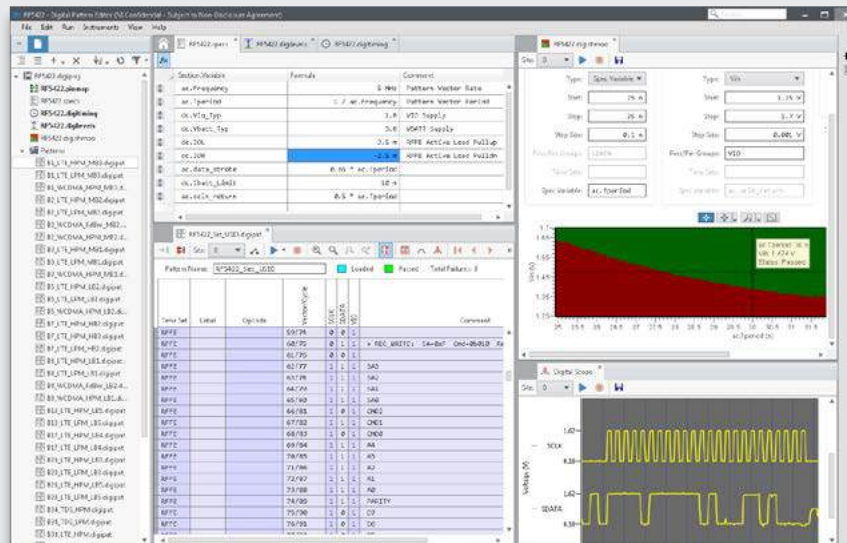

NI Digital Pattern Editor Application Software

The Digital Pattern Editor is an interactive tool for importing, editing, or creating test patterns. All the sheets developed in the Digital Pattern Editor can be reused by the API in LabVIEW, C, or .NET languages, as well as in the TestStand Semiconductor Module.

Pattern Development and Format

A pattern file is a collection of vectors, with each vector containing time sets, labels, opcodes, pin states, and comments. The Digital Pattern Editor has development sheets for all of these items, as well as debug tools for refining patterns, time sets, and specifications. A compiled, binary version of the pattern file is required to edit or burst. Engineers can compile an ASCII text pattern file format (.digipatsrc) into a binary version using the Digital Pattern Editor or a command line process. The ASCII form can be used to convert existing patterns by following the well-defined pattern file format. Design simulation and SCAN files generated by EDA tools can be cyclized and targeted to the NI format using existing customer in-house EDA workflows or third-party cyclizing tools.

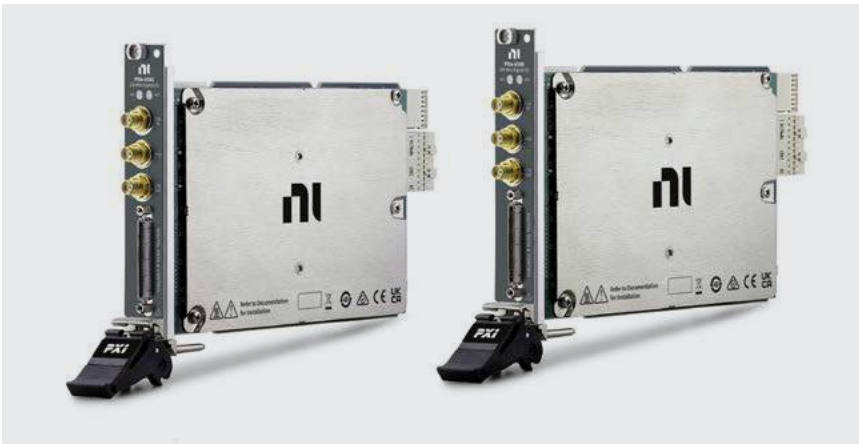

Recommended software (sold separately):

 LabVIEW

 Digital Waveform Editor

Additional resources for software development:

C/C++, C#, Python

 LabWindows/CVI

PXI Digital Waveform Instruments

- Standard TTL/CMOS interface voltages and programmable voltage levels
- 32 bidirectional digital channels
- Advanced waveform sequencing and streaming features
- Up to 200 Mb/s SDR and 400 Mb/s DDR

Key Features:

Synchronization and Memory Core (SMC)

The synchronization and memory core architecture is designed to enhance testing efficiency through deep onboard memory, flexible data transfer cores, and precise timing synchronization.

Dedicated Digital Waveform Editor

The Digital Waveform Editor is a software tool that facilitates creating, editing, and importing digital waveforms for customized interfacing and test conditions. The editor also supports the design of digital vectors with six drive and compare states.

Driver and API Support

The NI-HSDIO driver includes a flexible API based on IVI guidelines, complete documentation of supported hardware, and configuration and testing utilities to communicate with PXI digital waveform instruments.

PXI Digital Waveform Instrument Modules

Selection Guide	Model	Part Number	Number of Bidirectional Digital Channels	Logic Family	Maximum Sample Clock	Maximum Generation Rate	Maximum Acquisition Rate	Onboard Memory	Hardware Compare
Starter Module	PXIe-6544	780992-01	32	1.2 V, 1.5 V, 1.8 V, 2.5 V, 3.3 V	100 MHz	100 Mb/s SDR	100 Mb/s SDR	1 Mb/ch (4 MB total)	—
		780992-02						8 Mb/ch (32 MB total)	
		780992-03						64 Mb/ch (256 MB total)	
Higher Clock Rate	PXIe-6545	780993-01	32	1.2 V, 1.5 V, 1.8 V, 2.5 V, 3.3 V	200 MHz	200 Mb/s SDR	200 Mb/s SDR	1 Mb/ch (4 MB total)	—
		780993-02						8 Mb/ch (32 MB total)	
		780993-03						64 Mb/ch (256 MB total)	
Programmable Voltage Levels	PXIe-6547	781011-01	32	1.2 V–3.3 V Programmable	100 MHz	100 Mb/s SDR (200 Mb/s DDR)	100 Mb/s SDR (200 Mb/s DDR)	1 Mb/ch (4 MB total)	✓
		781011-02						8 Mb/ch (32 MB total)	
		781011-03						64 Mb/ch (256 MB total)	
Higher Clock Rate + Programmable Voltage Levels	PXIe-6548	781012-01	32	1.2 V–3.3 V Programmable	200 MHz	200 Mb/s SDR (400 Mb/s DDR)*	200 Mb/s SDR (300 Mb/s DDR)*	1 Mb/ch (4 MB total)	✓
		781012-02						8 Mb/ch (32 MB total)	
		781012-03						64 Mb/ch (256 MB total)	

*Maximum DDR data rate is dependent on logic family or programmed voltage level. See specs for mapping of voltage levels to data rates.

PXI Digital Waveform and Pattern Instrument Accessories

Digital Cables

Digital Cables	SHC68-C68-D4 Shielded Single-Ended Cable, 0.55 m	SHC68-C68-D4 Shielded Single-Ended Cable, 1 m	SHC68-C68-D4 Shielded Single-Ended Cable, 2 m	SHC68-C68-D4 Shielded Single-Ended Cable, Low Leakage, 1 m	SHC68-C68-D4 Shielded Single-Ended Cable, Lower DC Resistance, 3 m	C68-C68-D4 Unshielded Cable, 2X68-Position VHDCI Offset, 1 m	SHC68-H1X38 High-Speed Digital Flying-Leads Cable Accessory, 1.5 m
Part Number	781013-01	196275-01	781293-01	152870-01	132625-03	195949-01	192681-1R5
Shielding	Shielded	Shielded	Shielded	Shielded	Shielded	Unshielded	Shielded
PXIe-6570	✓	✓	✓	✓	✓	✓	✓
PXIe-6571	✓	✓	✓	✓	✓	✓	✓
PXIe-6544	✓	✓	✓	✓	✓	✓	✓
PXIe-6545	✓	✓	✓	✓	✓	✓	✓
PXIe-6547	✓	✓	✓	✓	✓	✓	✓
PXIe-6548	✓	✓	✓	✓	✓	✓	✓

Breakout Terminal Blocks, Boxes, and Adapters



Breakout Terminal Blocks, Boxes, and Adapters	SCB-68 HSDIO, Shielded 68-Pin Connector Block for R Series DIO and HSDIO Products	CB-2162 Single-Ended Digital I/O Accessory	SMB-2163 Single-Ended Digital I/O Accessory (Rack-Mountable)	653x Cable Adapter, 68-Pin D-Type to 68-Pin VHDCI Adapter	SCB-68A Noise-Rejecting, Shielded I/O Connector Block	CB-68LP Low-Cost, Unshielded I/O Connector Block	CB-68LPR I/O Connector Block	TBX-68, 68-Pin Screw Terminal Connector Block
Part Number	782914-01	778592-01	778747-01	195846-01	782536-01	777145-01	777145-02	777141-01
Receptacle	68-Pin 0.8 mm VHDCI	68-Pin 0.8 mm VHDCI	68-Pin 0.8 mm VHDCI	68-Pin SCSI 0.050 D-Type Female	68-Pin SCSI 0.050 D-Type Male	68-Pin SCSI 0.050 D-Type Male	68-Pin SCSI 0.050 D-Type Male	68-Pin SCSI 0.050 D-Type Female
Output Connections	Screw Terminal	Through-Hold and Surface-Mount Solder Pads	SMB	68-Pin 0.8 mm VHDCI	Screw Terminal	Screw Terminal	Screw Terminal	Screw Terminal
Shielding	Shielded	Unshielded	Shielded	N/A	Shielded	Unshielded	Unshielded	Unshielded
PXIe-6570	✓	✓	✓	—	—	—	—	—
PXIe-6571	✓	✓	✓	—	—	—	—	—
PXIe-6544	✓	✓	✓	✓	✓	✓	✓	✓
PXIe-6545	✓	✓	✓	✓	✓	✓	✓	✓
PXIe-6547	✓	✓	✓	✓	✓	✓	✓	✓
PXIe-6548	✓	✓	✓	✓	✓	✓	✓	✓



Recommended software (sold separately):

-  LabVIEW
-  InstrumentStudio Professional

Additional resources for software development:

- C/C++, C#, Python
-  InstrumentStudio
-  LabWindows/CVI

PXI Electronic Loads

- Ability to sink up to 300 W of DC power
- Voltage and current measurements with sample rates up to 1.8 MS/s and update rates up to 100 kS/s
- Hardware timing and triggering
- 4-wire remote sense

Key Features:

Acquire Data at High Speed

You can sink up to 300 W of power into the PXI electronic load module to test a range of electronic devices, all while gathering voltage and current measurements at rates up to 1.8 MS/s. The first PXI electronic load module in the industry also features high-speed data converters that offer update rates up to 100 kS/s.

Improve Accuracy with Selectable Ranges

When measuring voltage or current with the PXI electronic load module, you have multiple measurement ranges to choose from. You can enhance the accuracy of your measurement by selecting the most suitable range for the magnitude of the measurement, optimizing the ADC range.

Tune the Transient Response

You can maximize stability, reduce overshoot, and decrease test times by digitally controlling the transient response of the PXI electronic load module. NI SourceAdapt, a patented technology on the PXI electronic load module, power supplies, and source measure units (SMUs), eliminates custom circuitry.

PXI Electronic Load Modules

Selection Guide	Model	Part Number	PXI Slots	Maximum Voltage (V)	Maximum Current (A)	Maximum Power Per Channel (W)	Maximum Voltage Measurement Resolution	Maximum Current Measurement Resolution	SourceAdapt
1-Channel, 60 V, 40 A PXI Electronic Load Module	PXIe-4051	788179-01	3	60	40*	300	1 μ V	10 μ A	✓

*Requires an 82 W PXI chassis to achieve maximum power of 300 W

PXI Electronic Load Accessories

Connectors and Connector Kits

Connectors and Connector Kits	Connector Kit for PXIe-4150/1 Power Supplies and PXIe-4051 Electronic Load
Part Number	788197-01
PXIe-4051	✓



Recommended software (sold separately):

- ▶ LabVIEW
- ▶ LabVIEW Real-Time Module
- ▶ LabVIEW FPGA

Additional resources for software development:

- C/C++, Python,
▶ LabWindows/CVI

PXI High-Speed Serial

- Up to 48 Xilinx multigigabit transceivers (MGTs) with line rates up to 28.2 Gb/s
- Various high-speed serial protocols on the user-programmable Xilinx Kintex UltraScale + or 7 series FPGAs
- High-speed P2P backplane data streaming up to 7 GB/s to host, disk, or other PXI Express modules
- Up to 20 GB onboard DDR3 DRAM

Key Features:

Protocol Flexibility

PXI high-speed serial instruments leverage Xilinx FPGAs and flexible clocking circuitry to implement a variety of both standard and custom high-speed serial protocols.

Data Streaming

High-speed serial instruments benefit from PXI high-speed data movement capabilities. The modules have a PCI Express Gen 3 x8 interface for sustained data streaming rates of 7 GB/s unidirectional and 2.4 GB/s bidirectional to or from a host processor or other instruments that support P2P streaming.

Flexible Software Experience

PXI high-speed serial instruments support programming with either NI LabVIEW FPGA or VHDL via Xilinx Vivado.

PXI High-Speed Serial Modules

Selection Guide	Model	Part Number	HSS Physical Ports	Multi-Gigabit Transceivers (MGTS)	Max Line Rate (Gb/s)	Max Throughput (GB/s)	FPGA Family	High-Speed Serial Connector	PXI Express Slots
Lowest Cost	PXIe-6592	783639-01	4	4	10	5	Kintex-7 K410	SFP+	1
Low Cost	PXIe-6591	783638-01	2	8	12.5	13	Kintex-7 K410	MiniSAS-HD	1
	PXIe-6593	785976-01 785977-01	2	8	16.3	16	UltraScale KU040 UltraScale KU060	QSFP28	1
High Throughput, Large FPGA	PXIe-6594	786939-01	2	8	28.2	28	UltraScale+ KU15R	QSFP28	1
High Throughput	PXIe-7902	784232-01	6	24	12.5	38	Virtex-7	MiniSAS-HD	1
Highest Throughput, Largest FPGA	PXIe-7903	788917-01	12	48	28.2	169	UltraScale+ VU11P	MiniSAS-zHD	2

PXI High-Speed Serial Accessories

Cables

Cable	MINI-SAS HD Cable x4 Lanes, 1 m	MINI-SAS HD Cable x4 Lanes, 3 m	MINI-SAS HD Optical Cable x4 Lanes, 10 m	SMA-SMA Cable, 1 m	SMB-SMB Cable, 1 m	QSFP28-QSFP28 Cable, 1 m	QSFP28-QSFP28 Cable, 2 m	QSFP28-QSFP28 Active Optical Cable, 10 m
Part Number	783976-01	783977-01	783978-01	783469-01	188859-01	788256-01	788256-02	788257-10
PXIe-6591	✓	✓	—	✓	—	—	—	—
PXIe-6592	—	—	—	—	✓	—	—	—
PXIe-6593	—	—	—	✓	—	✓	✓	✓
PXIe-6594	—	—	—	✓	—	✓	✓	✓
PXIe-7902	✓	✓	✓	✓	—	—	—	—
PXIe-7903	—	—	—	✓	—	—	—	—

Cables (continued)



Cable	zHD to QSFP28 Cable, 2 m	zHD to zHD Cable, 1 m	zHD to zHD Cable, 2 m	zHD to zHD Cable, 0.5 m	SHC68-C68-D4 Single-Ended Cable, 1 m	SFP+ Copper Cable, 1 m	Nano-Pitch-Nano-Pitch Cable, 1 m	mHDMI to mHDMI, 1 m
Part Number	788928-02	788927-01	788927-02	788927-0R5	152870-01	784076-01	785486-01	784091-01
PXIe-6591	—	—	—	—	✓	—	—	—
PXIe-6592	—	—	—	—	—	✓	—	—
PXIe-6593	—	—	—	—	—	—	✓	—
PXIe-6594	—	—	—	—	—	—	✓	—
PXIe-7902	—	—	—	—	—	—	—	—
PXIe-7903	✓	✓	✓	✓	—	—	—	✓

Connector Blocks

Connector Block	CB-2162 Digital Connector Block	SCB-12 Nano-Pitch Connector Block	SCB-19 mHDMI Connector Block
Part Number	778592-01	787419-01	783959-01
PXIe-6591	✓	—	—
PXIe-6592	—	—	—
PXIe-6593	—	✓	—
PXIe-6594	—	✓	—
PXIe-7902	—	—	—
PXIe-7903	—	—	✓



Recommended software (sold separately):

-  LabVIEW
-  LabVIEW Real-Time Module

Additional resources for software development:

- C/C++
-  LabWindows/CVI

PXI Timing and Synchronization

- Generate high-stability PXI system reference clocks and high-resolution sample clocks
- Achieve synchronization over long distance through GPS, IEEE 1588, IRIG-B, or PPS
- Develop advanced timing and sync applications with NI-Sync and NI-TClk software
- Import and export system reference clocks for synchronization between multiple chassis or external devices

Key Features:

High-Stability, High-Accuracy Onboard Clock

Replace this backplane system reference clock using a higher accuracy oscillator for high-performance applications.

Time-Base Synchronization

Generate triggers and clock signals at programmable future times, and timestamp input events with the synchronized system time.

Advanced Clock and Trigger Routing

Timing and synchronization modules provide many more source-to-destination routes for more flexible designs and efficient use of system resources.

PXI Timing and Synchronization Modules

Selection Guide	Model	Part Number	Connector Types	Supported Timing Protocols	Onboard Oscillator Accuracy	DDS Range	Override PXI 10 MHz Backplane Clock	PXI Star-Capable	PXI Express DSTAR-Capable
Ethernet and GPS Time Sync	PXI-6683H	782110-01 782110-02	RJ-45, SMB	IEEE-1588, GPS, IRIG-B, IEEE-802.1as (Linux only), PPS	+/-3.5 ppm	—	—	—	—
Clock and Trigger Routing and Generation	PXIe-6672	783639-01	SMB	—	+/-3.5 ppm	DC to 105 MHz	✓	✓	—
High-Performance Clock and Trigger Routing and Generation	PXIe-6674T	785976-01	SMA	—	+/-80 ppb	0.3 Hz to 1 GHz	✓	✓	✓

PXI Timing and Synchronization Accessories

Cables and Terminal Blocks

Description	Ethernet Cable, 2 m	Ethernet Cable, 5 m	GPS Antenna, Bullet III	SMB-SMB Cable, 1 m	SMB-Alligator Cable	SMB-Alligator Cable	SMA-SMA Cable, 1 m
Part Number	151733-02	151733-05	196304-30	188859-01	763388-01	763388-01	783469-01
PXI-6683H	✓	✓	✓	✓	✓	—	—
PXIe-6672	—	—	—	✓	—	✓	—
PXIe-6674T	—	—	—	—	—	—	✓



Recommended software (sold separately):

▶ LabVIEW

+ LabVIEW Sound and Vibration Toolkit

Additional resources for software development:

C/C++, C#, Python,

▣ LabWindows/CVI

PXI Sound and Vibration Modules

- Dynamic sensor measurements at 51.2 kS/s, 102.4 kS/s, 204.8 kS/s, or 1.25 MS/s
- Built-in highpass filtering
- Reliable dynamic signal characterization
- Per-channel, software-selectable AC input coupling
- Per-channel, software-selectable input gain settings

Key Features:

Perform Signal-Chain Distortion Analysis

The PXIe-4468 sound and vibration module supports benchtop-quality signal-chain distortion analysis in a single-slot PXI Express form factor. Additional new features include Pure Tone sine wave generation mode for more test coverage as well as support for independent operation and synchronization of each channel for improved utilization in test systems.

Generate and Acquire High-Dynamic-Range Signals

NI's PXI Sound and Vibration Module is a dynamic signal acquisition (DSA) device that can accurately measure the frequency content of signals with a very high dynamic range. Modules provide software-configurable AC/DC coupling, antialiasing filters, and IEPE conditioning to ensure precision measurements with microphones, accelerometers, and other transducers with large dynamic ranges.

Add Accelerometer Measurements to Your System

PXI Sound and Vibration Modules and the accompanying NI software make it fast to connect microphones and accelerometers for vibration test and measurement. NI-DAQmx supports NI programming environments as well as Python, ANSI C, C#.NET, and MathWorks® MATLAB® software.

PXI Sound and Vibration Modules

Selection Guide	Model	Part Number	DSA Dynamic Range	Highpass Filter Cutoff Frequency	Max Differential Analog	Max Sample Rate	Analog Output Channels	Gain Settings	Front Connection Type
AO Only	PXIe-4463	783086-01	—	3.4 Hz	—	51.2 kS/s	2	3	BNC
		783086-02							Mini-XLR
AI Only	PXIe-4464	783087-01	119 dB	0.72 Hz	4	204.8 kS/s	—	6	BNC
		783087-02							Mini-XLR
2 AI, 2 AO	PXIe-4468	788511-01	121 dB	0.8 Hz	2	250 kS/s	2	6	BNC
		788512-01							Mini-XLR
High Bandwidth with Signal Conditioning	PXIe-4480*	784277-01	115 dB	0.5 Hz	6	1.25 MS/s	—	4	InfiniBand (IB)
High Bandwidth	PXIe-4481	784278-01	115 dB	0.5 Hz	6	1.25 MS/s	—	4	InfiniBand (IB)

*Antialiasing Filter, Voltage Excitation, Current Excitation Signal Conditioning

PXI Sound and Vibration Modules Accessories

Cables

Cables	BNC Male to BNC Male Cable, 75 Ω, 2 m (x4)	Extended Temperature, BNCM-MXLRF, 0.46 m	Extended Temperature, BNCM-MXLRF 0.91 m	Extended Temperature, BNCM-MXLRF 2.4 m	Extended Temperature, MXLRF-MXLRF 0.46 m
Part Number	779697-02	140150-0R46	140150-0R91	140150-2R4	140151-0R46
PXIe-4463, MXLR [783086-02]	—	✓	✓	✓	✓
PXIe-4463, BNC [783086-01]	✓	—	—	—	—
PXIe-4464, MXLR [783097-02]	—	✓	✓	✓	✓
PXIe-4464, BNC [783097-01]	✓	—	—	—	—
PXIe-4468, MXLR [788512-01]	—	✓	✓	✓	✓
PXIe-4468, BNC [788511-01]	✓	—	—	—	—
PXIe-4480, InfiniBand [784277-01]	—	—	—	—	—
PXIe-4481, Infiniband [784278-01]	—	—	—	—	—

Cables (continued)

Cables	Extended Temperature, MXLRF-MXLRF 0.91 m	Extended Temperature, MXLRF-MXLRF 2.4 m	Extended Temperature, MXLRF-XLRM, 0.46M, 3-Pin Female Mini-XLR	SMB-100, SMB Female to BNC Female Coax Cable, 50 Ω, 0.08 m	SMB-100, SMB Female to BNC Female Coax Cable, 50 Ω, 0.6 m
Part Number	140151-0R91	140151-2R4	140152-0R46	781449-01	763389-01
PXIe-4463, MXLR [783086-02]	✓	✓	✓	—	—
PXIe-4463, BNC [783086-01]	—	—	—	✓	✓
PXIe-4464, MXLR [783097-02]	✓	✓	✓	—	—
PXIe-4464, BNC [783097-01]	—	—	—	✓	✓
PXIe-4468, MXLR [788512-01]	✓	✓	✓	✓	✓
PXIe-4468, BNC [788511-01]	—	—	—	✓	✓
PXIe-4480, InfiniBand [784277-01]	—	—	—	—	—
PXIe-4481, Infiniband [784278-01]	—	—	—	—	—

Cables (continued)

Cables	SMB Female to 2 Alligator Clips Cable, 50 Ω, 1 m	SMB Female to BNC Male Coax Cable, 50 Ω, 1 m	InfiniBand SHB12x-6BNC, 0.2 m	InfiniBand SHB12x-6MXLRM, 0.2 m	InfiniBand SHB12x-6RJ50, 0.2 m
Part Number	763388-01	763405-01	140296-0R2	140303-0R2	140304-0R2
PXIe-4463, MXLR [783086-02]	—	—	—	—	—
PXIe-4463, BNC [783086-01]	✓	✓	—	—	—
PXIe-4464, MXLR [783097-02]	—	—	—	—	—
PXIe-4464, BNC [783097-01]	✓	✓	—	—	—
PXIe-4468, MXLR [788512-01]	✓	✓	—	—	—
PXIe-4468, BNC [788511-01]	✓	✓	—	—	—
PXIe-4480, InfiniBand [784277-01]	—	—	✓	✓	✓
PXIe-4481, Infiniband [784278-01]	—	—	✓	✓	✓

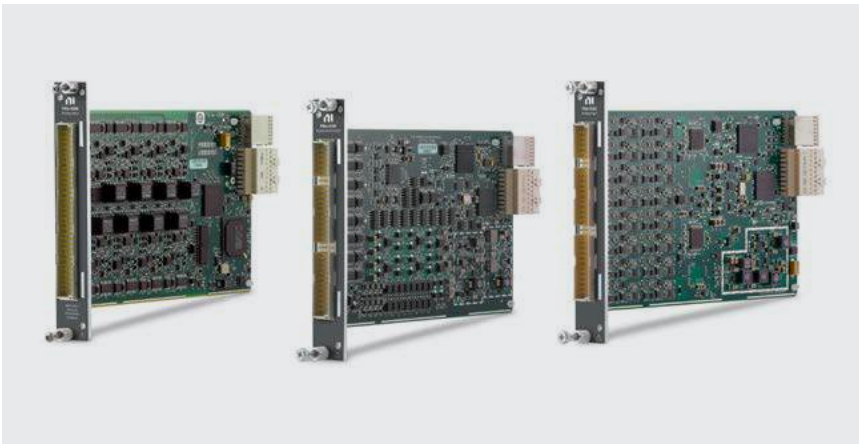

Recommended software (sold separately):

 LabVIEW

Additional resources for software development:

C/C++, C#, Python,

 LabWindows/CVI

PXI Signal-Conditioning Modules

- High channel density for conditioned and sensor measurements
- Flexible, synchronized, and accurate measurements
- Isolated measurement options
- Swappable front-mount terminal block

Key Features:

Accessory Auto-Detection

SC Express modules automatically detect compatible accessories or terminal blocks. The RSVD pins on the I/O connector provide power to the accessories as well as digital communication lines.

Multiple Timing Engines

Several SC Express modules are equipped with multiple timing engines, each customizable with its own configuration settings for timing, triggering, and sample mode (buffered or hardware-timed single point). This feature enables devices to execute multiple tasks simultaneously.

Chopping Mode

The PXIe-4309 supports chopping mode, which is a feature that can be used to remove offset voltages and other low frequency errors. By measuring a signal twice, once normally and once with the inputs inverted, the measurements can be averaged by the device to create each sample. This provides significant noise rejection to enable 10 nV measurements and better measurement stability over temperature.

PXI Analog Input and Output Modules

Selection Guide	Model Name	Part Number	Analog Input Isolation	Analog Input Resolution	Analog Input Voltage Range	Discrete Lowpass Filter	Filtering	Max Differential Analog	Max Sample Rate
Isolated AI	PXIe-4300	781337-01	300 V Ch-Ch Isolation	16 Bits	-300 V to 300 V -150 V to 150 V -60 V to 60 V -30 V to 30 V -10 V to 10 V -5 V to 5 V -2 V to 2 V -1 V to 1 V	10 kHz 100 kHz	Butterworth	8	250 kS/s/ch
General-Purpose Filtered AI	PXIe-4302	783865-01	—	24 Bits	-10 V to 10 V -0.1 V to 0.1 V	2 Hz; 20 Hz; 200 Hz; 1 kHz; 2 kHz	Anti-Alias	32	5 kS/s/ch
General-Purpose Filtered AI with Higher Sampling	PXIe-4303	783866-01	—	24 Bits	-10 V to 10 V -0.1 V to 0.1 V	2 Hz; 20 Hz; 200 Hz; 1 kHz; 2 kHz	Anti-Alias	32	51.2 kS/s/ch
High-Voltage Filtered AI	PXIe-4304	783867-01	—	24 Bits	-42 V to 42 V	2 Hz; 20 Hz; 200 Hz; 1 kHz; 2 kHz	Anti-Alias	32	5 kS/s/ch
High-Voltage Filtered AI with Higher Sampling	PXIe-4305	783868-01	—	24 Bits	-42 V to 42 V	2 Hz 20 Hz 200 Hz 1 kHz 2 kHz	Anti-Alias	32	51.2 kS/s/ch
High-Resolution Simultaneous AI	PXIe-4309	784471-01	—	28 Bits	-15 V to 15 V -10 V to 10 V -1 V to 1 V -0.1 V to 0.1 V	—	Anti-Alias	32	2 MS/s/ch
Highest-Voltage Isolated AI	PXIe-4310	784813-01	600 V Ch-Ch Isolation	16 Bits	-600 V to 600 V -300 V to 300 V -120 V to 120 V -60 V to 60 V -10 V to 10 V -5 V to 5 V -2 V to 2 V -1 V to 1 V	10 kHz; 100 kHz	Butterworth	8	400 kS/s/ch
Isolated AO	PXIe-4322	782878-01	—	16 Bits	-16 V to 16 V	—	—	8	250 kS/s/ch

PXI Strain Bridge Input Modules

Selection Guide	Model Name	Part Number	Analog Input Voltage Range	Bridge Configurations	Bridge Resistance	Max Differential Analog	Max Sample Rate
Starter Module	PXIe-4330	781346-01	-100 mV/V to 100 mV/V -25 mV/V to 25 mV/V	Full-Bridge Quarter-Bridge Half-Bridge	120 Ω 350 Ω 1,000 Ω	8	25.6 kS/s
Fastest Sample Rates	PXIe-4331	781345-01	-100 mV/V to 100 mV/V -25 mV/V to 25 mV/V	Full-Bridge Half-Bridge Quarter-Bridge	120 Ω 350 Ω 1,000 Ω	8	102.4 kS/s
Largest Input Ranges	PXIe-4339	783531-01	-10 V to 10 V -4 V to 4 V -1 V to 1 V -0.5 V to 0.5 V -0.2 V to 0.2 V -200 mV/V to 200 mV/V -0.1 V to 0.1 V -80 mV/V to 80 mV/V -50 mV/V to 50 mV/V -40 mV/V to 40 mV/V -20 mV/V to 20 mV/V -10 mV/V to 10 mV/V	Quarter-Bridge Full-Bridge Half-Bridge	120 Ω 350 Ω 1,000 Ω	8	25.6 kS/s

PXI Displacement Input Modules

Selection Guide	Model	Part Number	Analog Input Resolution	Input Level	Analog Inputs	Max Sample Rate	Excitation Voltage	Excitation Frequency	Max Sample Rate
Displacement Module	PXIe-4340	785068-01	24 Bits	+/-7 V _{rms}	4	25.6 kS/s	1-7 V _{rms} with 0.5 V _{B,rms} Increments	400 Hz to 10 kHz with 10 Hz Increments	25.6 kS/s

PXI Temperature Input Modules

Selection Guide	Model Name	Part Number	Supported Sensor Type	Analog Input Isolation	Max Number of Differential Analog
Thermocouple Module	PXIe-4353	781348-01	Thermocouple	300 V Bank Isolation	32
RTD Measurement Module	PXIe-4357	782118-01	RTD	—	20

PXI Signal-Conditioning Accessories

Terminal Blocks

Description	TB-4300, 10 V Input	TB-4300, 20 mA Input	TB-4300B, 300 V Input	TB-4302, 10 V Input	TB-4302, 20 mA Input	TB-4304	TB-4309, Screw Terminals
Part Number	781338-01	784280-01	781338-02	783869-01	783871-01	783870-01	784956-01
PXIe-4300	✓	✓	✓	—	—	—	—
PXIe-4302	—	—	—	✓	✓	—	—
PXIe-4303	—	—	—	✓	✓	—	—
PXIe-4304	—	—	—	—	—	✓	—
PXIe-4305	—	—	—	—	—	✓	—
PXIe-4309	—	—	—	—	—	—	✓

Terminal Blocks (continued)

Description	TB-4309, VHDCI Terminals	TB-4309, High Channel Density VHDCI Terminal	TB-4310, 10 V Input	TB-4310, 600V Input	TB-4310, 10 V Input, 10 Hz Filter	TB-4322	TB-4330
Part Number	784957-01	785743-01	785021-01	785022-01	786281-01	782882-01	781347-01
PXIe-4309	✓	✓	—	—	—	—	—
PXIe-4310	—	—	✓	✓	✓	—	—
PXIe-4322	—	—	—	—	—	✓	—
PXIe-4330	—	—	—	—	—	—	✓
PXIe-4331	—	—	—	—	—	—	✓

Terminal Blocks (continued)

Description	TB-4339, 120 Ohm 1/4 Bridge, 50K-Ohm Shunt Cal	TB-4339B, 350 Ohm 1/4 Bridge, 100K Ohm Shunt Cal	TB-4339C, 1K Ohm 1/4 Bridge, 100K Ohm Shunt Cal	TB-4340	TB-4353, Isothermal Terminal Block	TC-4353, mini TC Connector Terminal Block	TB-4357
Part Number	783532-01	783533-01	783534-01	784087-01	781349-01	782403-01	782119-01
PXIe-4339	✓	✓	✓	—	—	—	—
PXIe-4340	—	—	—	✓	—	—	—
PXIe-4353	—	—	—	—	✓	✓	—
PXIe-4357	—	—	—	—	—	—	✓

Rack Mounts

Rack Mount	RM-4302	RM-4304	RM-24999	RM-4339, Rack Mount TB for PXIe-4339 with in Situ Calibration	Custom Shunt Calibration Accessory for RM-4339 (SCAL-4339)
Part Number	783872-01	783873-01	785840-01	783535-01	783536-01
PXIe-4302	✓	—	—	—	—
PXIe-4303	✓	—	—	—	—
PXIe-4304	—	✓	—	—	—
PXIe-4305	—	✓	—	—	—
PXIe-4331	—	—	✓	—	—
PXIe-4339	—	—	—	✓	✓

Cables

Description	SH96-96-2 Cable (1 m)	SH96-96-2 Cable (3 m)	SH96-96-2 Cable (5 m)	SH96F-96M-42 V Shielded Cable for PXIe-4304/5 to Rack-Mount Terminal Block, 1 m	SH96F-96M-42 V Shielded Cable for PXIe-4304/5 to Rack-Mount Terminal Block, 3 m	SH96F-96M-42 V Shielded Cable for PXIe-4304/5 to Rack-Mount Terminal Block, 5 m	SH96-96-1, 1 m	SH96-96-1, 3 m	SH96-96-1, 5 m
Part Number	157350-01	157350-03	157350-05	158228-01	158228-03	158228-05	190668-01	190668-03	190668-05
PXIe-4302	✓	✓	✓	—	—	—	—	—	—
PXIe-4303	✓	✓	✓	—	—	—	—	—	—
PXIe-4304	—	—	—	✓	✓	✓	—	—	—
PXIe-4305	—	—	—	✓	✓	✓	—	—	—
PXIe-4339	✓	✓	✓	—	—	—	—	—	—
PXIe-4353	—	—	—	—	—	—	✓	✓	✓

Calibration Accessories

Calibration Accessories	CAL-4300B	CAL-4309	CAL-4330	CAL-4353
Part Number	781852-01	784958-01	786988-01	781350-01
PXIe-4300	✓	—	—	—
PXIe-4309	—	✓	—	—
PXIe-4330	—	—	✓	—
PXIe-4353	—	—	—	✓

Sensors

Sensors	J-Type Fiberglass Thermocouple, 1 m (32 °F to 900 °F)	J-Type Fiberglass Thermocouple, 2 m (32 °F to 900 °F)	K-Type Fiberglass Thermocouple, 1 m (3-2 °F to 900 °F)	K-Type Fiberglass Thermocouple, 2 m (32 °F to 900 °F)	K-Type Thermocouple Wire, 30 m (32 °F to 900 °F)	K-Type Thermocouple Wire, 300 m (32 °F to 900 °F)	T-Type Fiberglass Thermocouple, 2 m (32 °F to 500 °F)	3-Wire, 100 Ω Platinum RTD (Field-Cuttable Probe)
Part Number	745690-J001	745690-J002	745690-K001	745690-K002	745687-K030	745687-K300	745690-T002	745686-01
PXIe-4353	✓	✓	✓	✓	✓	✓	✓	—
PXIe-4357	—	—	—	—	—	—	—	✓



Recommended software (sold separately):

 LabVIEW

 LabVIEW FPGA

Additional resources for software development:

C/C++, Python

PXI Reconfigurable I/O Module (FPGA)

- Variety of onboard FPGA options
- 12-bit to 18-bit analog input resolution
- Up to 16 analog channels and 96 bidirectional channels
- Up to 1 MS/s analog sample rate

Key Features:

Flexible Functionality

Match individual application requirements to mimic the functionality of fixed I/O devices. You also can use it with software in timing and triggering applications such as control and hardware-in-the-loop (HIL) simulations.

Accelerate FPGA Programming

The software behind NI R Series modules gives you the flexibility to implement a custom FPGA design from scratch and the support of starting from a host-based driver.

Real-Time Signal Processing

PXI R Series modules have the resources you need to engineer complex algorithms, process data in real time between the I/O and CPU, and deploy your designs to hardware.

PXI Reconfigurable I/O Modules (FPGA)

Category	Model	Part Number	Analog Input Voltage Range	Digital I/O Logic Levels	Dynamic RAM (DRAM)	FPGA	Max Clock Rate	Max Sample Rate	Channels
Multifunction I/O, General Purpose	PXI-7841	780337-01	-10 V to 10 V	3.3 V 5 V	0 MB	Virtex-5 LX30	40 MHz	200 kS/s	Analog Input: 8 Analog Output: 8 Digital: 96
	PXI-7842	780338-01	-10 V to 10 V	3.3 V 5 V	0 MB	Virtex-5 LX50	40 MHz	200 kS/s	Analog Input: 8 Analog Output: 8 Digital: 96
	PXIe-7846	784143-01	-10 V to 10 V -5 V to 5 V -2 V to 2 V -1 V to 1 V	1.2 V 1.5 V 1.8 V 2.5 V 3.3 V	0 MB	Kintex-7 160T	80 MHz	500 kS/s	Analog Input: 8 Analog Output: 8 Digital: 48
Fast Clock Rate	PXI-7851	780339-01	-10 V to 10 V	3.3 V 5 V	0 MB	Virtex-5 LX30	40 MHz	750 kS/s	Analog Input: 8 Analog Output: 8 Digital: 96
	PXI-7852	780340-01	-10 V to 10 V	3.3 V 5 V	0 MB	Virtex-5 LX50	40 MHz	750 kS/s	Analog Input: 8 Analog Output: 8 Digital: 96
	PXI-7853	780341-01	-10 V to 10 V	3.3 V 5 V	0 MB	Virtex-5 LX85	40 MHz	750 kS/s	Analog Input: 8 Analog Output: 8 Digital: 96
	PXI-7854	780342-01	-10 V to 10 V	3.3 V 5 V	0 MB	Virtex-5 LX110	40 MHz	750 kS/s	Analog Input: 8 Analog Output: 8 Digital: 96
	PXIe-7856	784145-01	-10 V to 10 V -5 V to 5 V -2 V to 2 V -1 V to 1 V	1.2 V 1.5 V 1.8 V 2.5 V 3.3 V	0 MB	Kintex-7 160T	80 MHz	1 MS/s	Analog Input: 8 Analog Output: 8 Digital: 48
Dynamic RAM (DRAM) Available	PXIe-7847	784144-01	-10 V to 10 V -5 V to 5 V -2 V to 2 V -1 V to 1 V	1.2 V 1.5 V 1.8 V 2.5 V 3.3 V	512 MB	Kintex-7 160T	80 MHz	500 kS/s	Analog Input: 8 Analog Output: 8 Digital: 48
	PXIe-7857	784146-01	-10 V to 10 V -5 V to 5 V -2 V to 2 V -1 V to 1 V	1.2 V 1.5 V 1.8 V 2.5 V 3.3 V	512 MB	Kintex-7 160T	80 MHz	1 MS/s	Analog Input: 8 Analog Output: 8 Digital: 48
	PXIe-7861	786671-01	-10 V to 10 V -5 V to 5 V -2 V to 2 V -1 V to 1 V	3.3 V	512 MB	Kintex-7 160T	10 MHz	1 MS/s	Analog Input: 16 Analog Output: 8 Digital: 32
	PXIe-7865	787355-01	-10 V to 10 V -5 V to 5 V -2 V to 2 V -1 V to 1 V	5 V 3.3 V	512 MB	Kintex-7 160T	20 MHz	1 MS/s	Analog Input: 2 Analog Output: 24 Digital: 32
	PXIe-7867	785570-01	-10 V to 10 V -5 V to 5 V -2 V to 2 V -1 V to 1 V	3.3 V	512 MB	Kintex-7 160T	80 MHz	1 MS/s	Analog Input: 6 Analog Output: 18 Digital: 48
	PXIe-7868	785571-01	-10 V to 10 V -5 V to 5 V -2 V to 2 V -1 V to 1 V	3.3 V	512 MB	Kintex-7 325T	80 MHz	1 MS/s	Analog Input: 6 Analog Output: 18 Digital: 48
Dynamic RAM (DRAM) Available, Largest FPGA	PXIe-7862	786672-01	-10 V to 10 V -5 V to 5 V -2 V to 2 V -1 V to 1 V	3.3 V	512 MB	Kintex-7 325T	10 MHz	1 MS/s	Analog Input: 16 Analog Output: 8 Digital: 32
	PXIe-7866	787354-01	-10 V to 10 V -5 V to 5 V -2 V to 2 V -1 V to 1 V	3.3 V 5 V	512 MB	Kintex-7 325T	20 MHz	1 MS/s	Analog Input: 2 Analog Output: 24 Digital: 32
	PXIe-7858	784147-01	-10 V to 10 V -5 V to 5 V -2 V to 2 V -1 V to 1 V	1.2 V 1.5 V 1.8 V 2.5 V 3.3 V	512 MB	Kintex-7 325T	80 MHz	1 MS/s	Analog Input: 8 Analog Output: 8 Digital: 48

PXI Reconfigurable I/O Accessories (FPGA)

Cables



Cables	SHC68-68-RDIO Cable, 68-Pos .50 Series D-Type To 68-Pos VHDCI Offset, 1 m	SHC68-68-RMIO Cable, 68-Pos .50 Series D-Type To 68-Pos VHDCI Offset, 1 m	SHC68-68-RMIO Cable, 68-Pos .50 Series D-Type To 68-Pos VHDCI Offset, 2 m	Shielded R Series High-Speed Digital Cable, 2 m	Shielded R Series High-Speed Digital Cable, 1 m
Part Number	191667-01	189588-01	189588-02	156166-02	156166-01
PXI-7841	✓	✓	✓	—	—
PXI-7842	✓	✓	✓	—	—
PXI-7851	✓	✓	✓	—	—
PXI-7852	✓	✓	✓	—	—
PXI-7853	✓	✓	✓	—	—
PXI-7854	✓	✓	✓	—	—
PXIe-7846	—	✓	✓	✓	✓
PXIe-7847	—	✓	✓	✓	✓
PXIe-7856	—	✓	✓	✓	✓
PXIe-7857	—	✓	✓	✓	✓
PXIe-7858	—	✓	✓	✓	✓
PXIe-7861	—	✓	✓	✓	✓
PXIe-7862	—	✓	✓	✓	✓
PXIe-7865	—	✓	✓	✓	✓
PXIe-7866	—	✓	✓	✓	✓
PXIe-7867	—	✓	✓	✓	✓
PXIe-7868	—	✓	✓	✓	✓

Connector Block

Model	SCB-68A Shielded Connector Block	SCB-68 HSDIO, Shielded 68-Pin Connector Block
Part Number	782536-01	782914-01
PXI-7841	✓	—
PXI-7842	✓	—
PXI-7851	✓	—
PXI-7852	✓	—
PXI-7853	✓	—
PXI-7854	✓	—
PXIe-7846	✓	✓
PXIe-7847	✓	✓
PXIe-7856	✓	✓
PXIe-7857	✓	✓
PXIe-7858	✓	✓
PXIe-7861	✓	✓
PXIe-7862	✓	✓
PXIe-7865	✓	✓
PXIe-7866	✓	✓
PXIe-7867	✓	✓
PXIe-7868	✓	✓



Recommended software (sold separately):

-  LabVIEW
-  LabVIEW Real-Time Module
-  LabVIEW FPGA

Additional resources for software development:

- C/C++, Python,
-  LabWindows/CVI

PXI NI FlexRIO

- Analog I/O up to 6.4 GS/s, digital I/O up to 1.25 Gb/s, RF I/O up to 4.4 GHz
- High-performance Xilinx FPGAs with up to 20 GB of onboard DRAM
- Program with LabVIEW FPGA or Xilinx Vivado
- Develop application-specific I/O with the FlexRIO Module Development Kit

Key Features:

Leverage Rapidly Evolving Technology

FlexRIO provides the latest high-speed converter and FPGA technologies before they are widely available in commercial instruments. You can use FlexRIO to develop applications that push the requirements for sample rate, bandwidth, resolution, and channel count.

Accelerate FPGA Programming

LabVIEW FPGA is a powerful tool for designing and implementing custom hardware circuits that can provide high-speed and low-latency processing for a wide range of applications.

Process Signals in Real Time

FlexRIO can help you keep up with faster converters. Modules from the Xilinx Kintex UltraScale FPGA to the Xilinx Virtex UltraScale+ VU11P FPGA, paired with LabVIEW FPGA, provide the resources you need to engineer complex algorithms, process data in real time between the I/O and CPU, and deploy your designs to hardware.

FPGA Modules for FlexRIO

Selection Guide	Model	Part Number	FPGA	FPGA Slices	FPGA DSP Slices	FPGA Block RAM (Kb)	Onboard Memory	Streaming Throughput
Highest Performance	PXIe-7976	783625-01	Kintex 7 K410T	63,550	1,540	28,620	2 GB	3.2 GB/s
Larger FPGA	PXIe-7975	782955-01	Kintex 7 K410T	63,550	1,540	28,620	2 GB	1.7 GB/s
Lower Cost with DRAM	PXIe-7972	782954-01	Kintex 7 K325T	50,950	840	16,020	2 GB	1.7 GB/s
Lowest Cost	PXIe-7971	782953-01	Kintex 7 K325T	50,950	840	16,020	0 GB	1.7 GB/s

FPGA Modules and Adapter Module Compatibility

Adapter Module Compatibility

Adapter Module Type	FlexRIO Digitizer Adapter Modules					FlexRIO Signal Generator Adapter Modules	
Model	NI-5734	NI-5751B	NI-5752B	NI-5771	NI-5772	AT-1120	AT-1212
PXIe-7976	✓	✓	✓	✓	✓	✓	✓
PXIe-7975	✓	✓	✓	✓	✓	✓	✓
PXIe-7972	✓	✓	✓	✓	✓	✓	✓
PXIe-7971	✓	✓	✓	✓	✓	✓	✓

Adapter Module Compatibility (continued)

Adapter Module Type	FlexRIO Digital Adapter Modules					FlexRIO Transceiver Adapter Modules	FlexRIO RF Adapter Modules	FlexRIO Camera Link Adapter Modules
Model	NI-6581B	NI-6583	NI-6584	NI-6585B	NI-6589	NI-5783	NI-5791	NI-1483
PXIe-7976	✓	✓	✓	✓	✓	✓	✓	✓
PXIe-7975	✓	✓	✓	✓	✓	✓	✓	✓
PXIe-7972	✓	✓	✓	✓	✓	✓	✓	✓
PXIe-7971	✓	✓	✓	✓	✓	✓	✓	✓

FlexRIO Digitizers Adapter Modules

Selection Guide	Model	Part Number	Compatible FPGA	Resolution	Channels	Maximum Sample Rate	Maximum Bandwidth	Coupling	Full-Scale Input Range	Connectivity
High-Resolution FlexRIO Digitizer FAM	NI-5734	781659-04	Refer to FPGA Modules for FlexRIO	16	4	120 MS/s	117 MHz	AC and DC	2 Vpp	BNC
High-Density FlexRIO Digitizer FAMs	NI-5751B	784061-01	Refer to FPGA Modules for FlexRIO	14	16	50 MS/s	26 MHz	DC	2 Vpp	VHDCI
	NI-5752B	784062-01	Refer to FPGA Modules for FlexRIO	12	32	50 MS/s	14 MHz	AC	2 Vpp	VHDCI
Wide-Bandwidth FlexRIO Digitizer FAMs	NI-5771	781419-02	Refer to FPGA Modules for FlexRIO	8	2	3 GS/s	900 MHz	DC	1.3 Vpp	SMA
	NI-5772	782097-01	Refer to FPGA Modules for FlexRIO	12	2	1.6 GS/s	2.2 GHz	AC	2 Vpp	SMA
		782097-02	Refer to FPGA Modules for FlexRIO	12	2	1.6 GS/s	2.2 GHz	DC	2 Vpp	SMA

FlexRIO Digitizer Adapter Modules Accessories

Cables

Cables	BNC Male (Plug) To BNC Male (Plug), 75 Ω , 2 m Cables, 4-Pack	SHH19-H19-AUX Shielded Single-Ended Cable For Aux Digital I/O With Jackscrew, 2 m	SHC68-C68-D4 Shielded Single-Ended Cable, Lower DC Resistance, 3 m	SHC68-C68-D4 Shielded Single-Ended Cable, Low Leakage, 1 m	SHC68-C68-D4 Shielded Single-Ended Cable, 1 m	SHC68-C68-D4 Shielded Single-Ended Cable, 0.55 m	SHC68-C68-D4 Shielded Single-Ended Cable, 2 m	SHC68-C68-D3, Male VHDCI To Male VHDCI, Shielded LVDS Cable, 1 m	Shc68-C68-D3, Male VHDCI To Male VHDCI, Shielded LVDS Cable, 2 m
Part Number	779697-02	152629-02	132625-03	152870-01	196275-01	781013-01	781293-01	188143-01	788905-02
NI-5734	✓	✓	—	—	—	—	—	—	—
NI-5751B	—	—	✓	✓	✓	✓	✓	—	—
NI-5752B	—	—	✓	✓	✓	✓	✓	✓	✓
NI-5771	—	✓	—	—	—	—	—	—	—
NI-5772	—	✓	—	—	—	—	—	—	—

Connector Block

Connector Blocks	SCB-19 Noise-Rejecting, Shielded AUX I/O Connector Block	SMB-2147 16-Channel Analog Input Accessory	SMB-2146 2-Ch Input, 16-Channel Output Digital I/O Accessory	SMB-2145 16-Channel Analog Input Accessory
Part Number	782444-01	781518-01	781517-01	781516-01
NI-5734	✓	—	—	—
NI-5751B	—	✓	—	—
NI-5752B	—	—	✓	✓
NI-5771	✓	—	—	—
NI-5772	✓	—	—	—

FlexRIO Digitizers With Integrated I/O Modules

Selection Guide	Model	Part Number	FPGA	Analog Input Bandwidth	Analog Input Resolution	Analog Input Voltage Range	Max Sample Rate	Voltage Input Channels	Analog Input Coupling	CableSense™	Dynamic RAM (DRAM)
High-Resolution Integrated FlexRIO Digitizer	PXIe-5763	785160-01	Kintex UltraScale KU035	225 MHz	16 Bits	-1 v to 1 v	500 MS/s	4	AC	—	0 GB
		785161-01	Kintex UltraScale KU040							—	4 GB
		785162-01	Kintex UltraScale KU060							—	4 GB
		785163-01	Kintex UltraScale KU035						DC	—	0 GB
		785164-01	Kintex UltraScale KU040							—	4 GB
		785165-01	Kintex UltraScale KU060							—	4 GB
	PXIe-5764	785166-01	Kintex UltraScale KU035	1.15 GHz	16 Bits	-1 V to 1 V	1 GS/s	4	AC	—	0 GB
		785167-01	Kintex UltraScale KU040							—	4 GB
		785168-01	Kintex UltraScale KU060							—	4 GB
		785169-01	Kintex UltraScale KU035						DC	—	0 GB
		785170-01	Kintex UltraScale KU040							—	4 GB
		785171-01	Kintex UltraScale KU060							—	4 GB
High-Bandwidth Integrated FlexRIO Digitizers	PXIe-5774	785646-01	Kintex UltraScale KU040	3 GHz	12 Bits	200 mVpp to 1 Vpp	6.4 GS/s	2	DC	—	4 GB
		785646-02	Kintex UltraScale KU040	1.6 GHz						—	
		785647-01	Kintex UltraScale KU060	3 GHz						—	
		785647-02	Kintex UltraScale KU060	1.6 GHz						—	
		785647-11	Kintex UltraScale KU060	3 GHz						✓	
		785647-12	Kintex UltraScale KU060	1.6 GHz						✓	
	PXIe-5775	785590-01	Kintex UltraScale KU035	6 GHz	12 Bits	1.25 Vpp	6.4 GS/s	2	AC	—	0 GB
		785591-01	Kintex UltraScale KU040							—	4 GB
		785592-01	Kintex UltraScale KU060							—	4 GB

FlexRIO Digitizers With Integrated I/O Accessories

Connector Block

	SCB-12, Nano-Pitch Connector Block, 8 SE DIO, 1 QSFP+	SCB-8 Noise-Rejecting, Shielded Nano-Pitch Connector Block
Part Number	787419-01	786335-01
PXIe-5763	✓	✓
PXIe-5764	✓	✓
PXIe-5774	✓	✓
PXIe-5775	✓	✓

FlexRIO Signal Generator Adapter Modules

Selection Guide	Model	Part Number	Compatible FPGA	Resolution (Bits)	Channels	Maximum Sample Rate	Maximum Bandwidth	Coupling	Signaling	Connectivity
High-Speed FlexRIO Signal-Generator FAMS	AT-1120	782248-01	Refer to FPGA Modules for FlexRIO	14	1	2 GS/s	550 MHz	DC	Differential	SMA
	AT-1212	782248-02	Refer to FPGA Modules for FlexRIO	14	2	1.25 GS/s	400 MHz	DC	Differential	SMA

FlexRIO Signal Generator Adapter Modules Accessories

Cables

Cables	SMA Male to SMA Male Cable, 50 Ω, 38.1 cm	SMA Male to SMA Male Cable, 50 Ω, 12.7 cm	SMA Male to SMA Male Cable for USRP, 50 Ω, 2 m	SMA Male to SMA Male Cable, 50 Ω, 30 cm
Part Number	763444-01	763443-01	783470-01	781846-01
AT-1120	✓	✓	✓	✓
AT-1212	✓	✓	✓	✓

FlexRIO Signal Generator Integrated I/O Modules

Selection Guide	Model	Part Number	FPGA	Resolution (Bits)	Channels	Maximum Sample Rate	Maximum Bandwidth	Coupling	Signaling	Connectivity	Reconstruction Filter
High-Speed Integrated FlexRIO Signal Generator	PXIe-5745	785596-01	Kintex UltraScale KU035	12	2	3.2 GS/s per Channel	2.9 GHz	AC	Single-Ended	SMA	—
		785596-02									✓
		785597-01	Kintex UltraScale KU040								—
		785597-02									✓
		785598-01	Kintex UltraScale KU060								—
		785598-02									✓

FlexRIO Signal Generator Integrated I/O Module Accessories

Connector Blocks

Connector Block	SCB-12, Nano-Pitch Connector Block, 8 SE DIO, 1 QSFP+	SCB-8 Noise-Rejecting, Shielded Nano-Pitch Connector Block
Part Number	787419-01	786335-01
PXIe-5745	✓	✓

FlexRIO Digital Adapter Modules

Selection Guide	Model	Part Number	Compatible FPGA	Digital I/O Termination	Duplex	Logic Levels And Range	Max Clock Rate	Max Data Rate	Number of Bidirectional Digital Channels	Signaling Type
General Purpose	NI-6581B	783887-01	Refer to FPGA Modules for FlexRIO	50 Ω	—	1.8 V 2.5 V 3.3 V	100 MHz	100 Mb/s	54	Single-Ended
General Purpose + LVDS	NI-6583	781320-01	Refer to FPGA Modules for FlexRIO	50 Ω	—	LVDS Programmable 1.2 V—3.3 V	200 MHz	300 Mb/s	32	Single-Ended Differential
		781320-02	Refer to FPGA Modules for FlexRIO			mLVDS Programmable 1.2 V—3.3 V				
RS422 and RS485	NI-6584	781290-01	Refer to FPGA Modules for FlexRIO	100 Ω	Half Duplex	RS422/RS485	16 MHz	16 Mb/s	16	Differential
		781290-02	Refer to FPGA Modules for FlexRIO	100 Ω	Full Duplex					
		781290-03	Refer to FPGA Modules for FlexRIO	N/A, External Termination Recommended	Full Duplex					
LVDS	NI-6585B	784060-01	Refer to FPGA Modules for FlexRIO	100 Ω	—	LVDS	200 MHz	300 Mb/s	32	Differential
LVDS	NI-6589	783888-01	Refer to FPGA Modules for FlexRIO	100 Ω	—	LVDS	1 GHz	1 Gb/s	20	Differential

FlexRIO Digital Adapter Module Accessories

Cables

Cable	C68-C68-D4 Unshielded Cable For High-Speed Digital I/O, 2X 68-Position VHDCI Offset, 1 m	SHC68-C68-D4 Shielded Single-Ended Cable, Lower DC Resistance, 3 m	SHC68-C68-D4 Shielded Single-Ended Cable, Low Leakage, 1 m	SHC68-C68-D4 Shielded Single-Ended Cable, 1 m	SHC68-C68-D4 Shielded Single-Ended Cable, 0.55 m	SHC68-C68-D4 Shielded Single-Ended Cable, 2 m	C68-C68-D4 Unshielded Cable For High-Speed Digital I/O, 2X 68-Position VHDCI Offset, 1 m
Part Number	195949-01	132625-03	152870-01	196275-01	781013-01	781293-01	195949-01
NI-6581B	✓	✓	✓	✓	✓	✓	✓
NI-6583	✓	✓	✓	✓	✓	✓	✓
NI-6584	✓	✓	✓	✓	✓	✓	✓
NI-6585B	—	—	—	—	—	—	—
NI-6589	—	—	—	—	—	—	—

Cables (continued)

Cable	SHB12X-B12X, Male InfiniBand to Male Infiniband, Shielded LVDS Cable, 1 m	SHB12X-B12X, Male InfiniBand to Male Infiniband, Shielded LVDS Cable, 2 m	SHB12X-H3X24, Male InfiniBand to Differential Flying Leads, Shielded LVDS Cable, 1.5 m	BNC Male (Plug) to BNC Male (Plug), 75 Ω, 2 m Cables, 4 Pack	SHC68-C68-D3, Male VHDCI to Male VHDCI, Shielded LVDS Cable, 1 m	SHC68-C68-D3, Male VHDCI to Male VHDCI, Shielded LVDS Cable, 2 m	68 Pos VHDCI Connector to Eight 9 POS D-SUB, RS485, 1 m
Part Number	192344-01	192344-02	196236-1R5	779697-02	188143-01	788905-02	197546-01
NI-6581B	—	—	—	—	—	—	—
NI-6583	✓	✓	✓	—	—	—	—
NI-6584	—	—	—	✓	—	—	✓
NI-6585B	—	—	—	—	✓	✓	—
NI-6589	✓	✓	✓	—	—	—	—

Breakout Boxes and Adapters

Breakout Boxes and Adapters	CB-2162 Single-Ended Digital I/O Accessory	SMB-2163 Single-Ended Digital I/O Accessory (Rack-Mountable)	SMA-2164 LVDS Prototyping Accessory	SMA-2165 Prototyping Accessory For NI 6585	SCB-68 HSDIO, Shielded 68-Pin Connector Block
Part Number	778592-01	778747-01	779323-01	782092-01	782914-01
NI-6581B	✓	✓	—	—	✓
NI-6583	✓	✓	✓	—	✓
NI-6584	✓	✓	—	—	✓
NI-6585B	—	—	—	✓	—
NI-6589	—	—	✓	—	—

FlexRIO Digital Integrated I/O Modules

Selection Guide	Model	Part Number	FPGA	Digital Input Only Channels	Digital Output Only Channels	Logic Levels And Range	Max Data Rate
LVDS FlexRIO Digital I/O Module	PXIe-6569	787280-01	Kintex UltraScale KU035	32	32	LVDS	300 Mb/s
		787281-01	Kintex UltraScale KU060	—	64		
		787282-01	Kintex UltraScale KU060	64	0		
		787283-01	Kintex UltraScale KU060	32	32		
		787284-01	Kintex UltraScale KU035	0	64		
		787285-01	Kintex UltraScale KU035	64	0		

FlexRIO Digital Integrated I/O Module Accessories

Cables

Cable	MINI-SAS HD Breakout Cable To 16 SMA	SR240M-SR240M Cable, LVDS With SE, 1 m	SR240M-SR240M Cable, LVDS With SE, 0.5 m
Part Number	788260-01	787317-01	787317-0R5
PXIe-6569	✓	✓	✓

Terminal Block

Terminal Block	TB-6569 High-Speed SEARAY To Mini-SAS HD Breakout
Part Number	788259-01
PXIe-6569	✓

FlexRIO Transceiver Adapter Modules

Selection Guide	Model	Part Number	Available Filters	Analog Input Sampling Rate	Compatible FPGA	IF Transceiver Max Bandwidth	Input Coupling	Max Analog Output Update Rate	Analog Input Channels	Analog Output Channels	Resolution
40 MHz Bandwidth Transceiver Adapter Module for FlexRIO	NI-5783	784364-01	Elliptic	100 MS/s	Refer to FPGA Modules for FlexRIO	175 MHz	DC	400 MS/s	4	4	16
		784364-02	Butterworth								

FlexRIO Transceiver Adapter Module Accessories

Cables

Cable	HD BNC Male to Bnc Female Cable, 50 Ω , 20 cm	HD BNC To SMA Cable, 50 Ω , 1 m	SHH19-H19-Aux Shielded Single-Ended Cable For Aux Digital I/O With Jackscrew, 2 m
Part Number	787230-0R2	784995-01	152629-02
NI-5783	✓	✓	✓

Digital Cables

Digital Cable	SHH19-H19-AUX Shielded Single-Ended Cable, 2 m
Part Number	152629-02
NI-5783	✓

Connector Blocks

Connector Block	SCB-19 Noise-Rejecting, Shielded Aux I/O Connector Block
Part Number	782444-01
NI-5783	✓

FlexRIO Transceiver Integrated I/O Modules

Selection Guide	Model	Part Number	FPGA	Dynamic RAM (DRAM)	Analog Output Bandwidth	Reconstruction Filter	Channels	Max Input Sample Rate	Max Output Sample Rate	Coupling	Resolution
12-Bit, 6.4 GS/s, 2-Channel PXI FlexRIO IF Transceiver	PXIe-5785	785584-01	Kintex UltraScale KU035	0 GB	2.9 GHz	—	2 AI, 2 AO	6.4 GS/s	3.2 GS/s	AC	12
		785584-02	Kintex UltraScale KU035	0 GB	2.4 GHz	✓					
		785585-01	Kintex UltraScale KU040	4 GB	2.9 GHz	—					
		785585-02	Kintex UltraScale KU040	4 GB	2.4 GHz	✓					
		785586-01	Kintex UltraScale KU060	4 GB	2.9 GHz	—					
		785586-02	Kintex UltraScale KU060	4 GB	2.4 GHz	✓					

FlexRIO Transceiver Integrated I/O Module Accessories

Cables

Description	Nano-Pitch Male to Nano-Pitch Male OCuLink x4 Cable, 1 m	SMA Male to SMA Male Cable, 50 Ω, 30 cm	SMA Male to SMA Male Cable, 50 Ω, 1 m
Part Number	785486-01	781846-01	781845-01
PXIe-5785	✓	✓	✓

Connector Block

Description	SCB-12, Nano-Pitch Connector Block, 8 SE DIO, 1 QSFP+	SCB-8 Noise-Rejecting, Shielded Nano-Pitch Connector Block
Part Number	787419-01	786335-01
PXIe-5785	✓	✓

FlexRIO RF Adapter Modules

Selection Guide	Model	Part Number	Input Noise Density	Max Input Power	Max Output Power	RF Analyzer Instantaneous Band	RF Generator Frequency Range	RF Generator Instantaneous Band	Compatible FPGA
100 MHz Bandwidth, 200 MHz to 4.4 GHz, RF Adapter Module for FlexRIO	NI-5791	782510-01	-148 dBm/Hz	20 dBm	8 dBm	100 MHz	200 MHz to 4.4 GHz	100 MHz	Refer to FPGA Modules for FlexRIO

FlexRIO RF Adapter Module Accessories

Cables

Description	SMA Male to SMA Male Cable, 50 Ω, 30 cm	SMA Male to SMA Male Cable, 50 Ω, 1 m
Part Number	781846-01	781845-01
NI-5791	✓	✓

FlexRIO Camera Link Adapter Modules

Selection Guide	Model	Part Number	Supported Configurations	Connector	Supported Pixel Clock Frequency	Aux I/O	Compatible FPGA
Full-Configuration Camera Link Adapter Module for FlexRIO	NI-1483	781341-01	Base, Medium, Full Camera Link	2x 26-Pin SDR	20–85 MHz	4x TTL, 2x Isolated Digital Inputs, 1x Quadrature Encoder	Refer to FPGA Modules for FlexRIO

FlexRIO Camera Link Adapter Module Accessories

Cables

Description	Cable, Power Over Camera Link (PoCL), MDR To MDR, 2 m	Cable, Power Over Camera Link (PoCL), MDR To MDR, 5 m	Cable, Power Over Camera Link (PoCL), MDR To SDR, 5 m	Cable, Power Over Camera Link (PoCL), SDR To SDR, 5 m
Part Number	199744-02	199744-05	199745-05	199746-05
NI-1483	✓	✓	✓	✓

FlexRIO Coprocessor Modules

Selection Guide	Model	Part Number	I/O	Block RAM	DSP Slices	Dynamic RAM	FPGA	Max Line Rate
Lowest Cost	PXIe-7912	785173-01	4 HSS MGTs 8 GPIO	21 Mb	1,920	4 GB	Kintex UltraScale KU040	16.375 Gb/s
Low Cost	PXIe-7915	785174-01	4 HSS MGTs 8 GPIO	38 Mb	2,760	4 GB	Kintex UltraScale KU060	16.375 Gb/s
Highest Throughput and Largest FPGA	PXIe-7903	788917-01	48 HSS MGTs 8 GPIO	341 Mb	9,216	20 GB	Virtex UltraScale+ XCVU11P	28.2 Gb/s

FlexRIO Coprocessor Module Accessories

Cables

Description	Nano-Pitch Male to Nano-Pitch Male OCuLink x4 Cable, 1 m	Nano-Pitch Male to Mini-SAS HD Male OCuLink x4 Cable, 1 m
Part Number	785486-01	786215-01
PXIe-7912	✓	✓
PXIe-7915	✓	✓

Connector Blocks

Description	SCB-12, Nano-Pitch Connector Block, 8 SE DIO, 1 QSFP+	SCB-8 Noise-Rejecting, Shielded Nano-Pitch Connector Block
Part Number	787419-01	786335-01
PXIe-7912	✓	✓
PXIe-7915	✓	✓

FlexRIO Camera Interface Modules

Selection Guide	Model	Part Number	Deserializer	Digital Input-Only Channels	Digital Output-Only Channels	Serializer	Supported Modes	Serial Link	FPGA
8-Channel GMSL2 Automotive Camera Interface Module	PXIe-1487	787456-01	MAX9296A	8	0	—	Pixel	GMSL2	Kintex UltraScale+ KU11P
		787457-01	MAX9296A	4	4	MAX9295A	Pixel		
		787458-01	—	0	8	MAX9295A	Pixel		
		788714-01	MAX96716A	4	4	MAX96717	Pixel Tunneling		
		788715-01	—	0	8	MAX96717	Pixel Tunneling		
		788716-01	MAX96716A	8	0	—	Pixel Tunneling		
		788719-01	—	0	8	MAX96717F	Pixel Tunneling		
		788781-01	MAX96716A	4	4	MAX96717F	Pixel Tunneling		
4-Channel GMSL3 Automotive Camera Interface Module	PXIe-1489	788355-01	MAX96792A	4	0	—	Pixel Tunneling	GMSL3	Kintex UltraScale+ KU11P
		788356-01	MAX96792A	2	2	MAX96793	Pixel Tunneling		
		788357-01	—	0	4	MAX96793	Pixel Tunneling		
8-Channel FPD-LINK III Automotive Camera Interface Module	PXIe-1486	787453-01	DS90UB954	8	0	—	—	FPD-LINK III	Kintex UltraScale+ KU11P
		787454-01	DS90UB954	4	4	DS90UB953	—		
		787455-01	—	0	8	DS90UB9702	—		
		788711-01	DS90UB638	8	0	—	—		
		788712-01	DS90UB638	4	4	DS90UB635	—		
		788713-01	—	0	8	DS90UB635	—		
8-Channel FPD-LINK IV Automotive Camera Interface Module	PXIe-1488	788350-01	DS90UB791	8	0	—	—	FPD-LINK IV	Kintex UltraScale+ KU11P
		788351-01	DS90UB9702	4	4	DS90UB791	—		
		788352-01	—	0	8	DS90UB9702	—		

PXI DAQ

PXI Analog I/O

- Analog input modules
- Analog output modules
- Displacement input modules
- Strain/bridge input modules
- Temperature input modules

PXI Digital I/O

- Acquire and generate digital signals and patterns at multiple logic levels
- Characterize circuits, toggle control lines, and meet many other digital application needs

PXI Multifunction I/O

- Voltage measurements up to 10 MS/s per channel
- Analog, digital and counter/timer I/O in one device
- Multiplexed or simultaneous analog architectures
- Software-selectable input ranges and input channel isolation available
- Up to four analog output channels and four counters/timers

Key Features:

High-Resolution, High-Accuracy Measurements

NI PXI DAQ modules have been meticulously designed, tested, and calibrated to achieve the highest possible accuracy across all input channels.

Advanced Timing Technology

Much of the PXI multifunction I/O module family provides up to four enhanced counters, a 100 MHz timebase, and additional options for native, advanced I/O timing and triggering.

A Family of Products Built around Flexibility

Because measurement requirements vary significantly from one application to the next, the PXI platform's modularity makes custom hardware configuration easy. Furthermore, the breadth of specification options for PXI data acquisition modules covers a wide swath of circumstances.

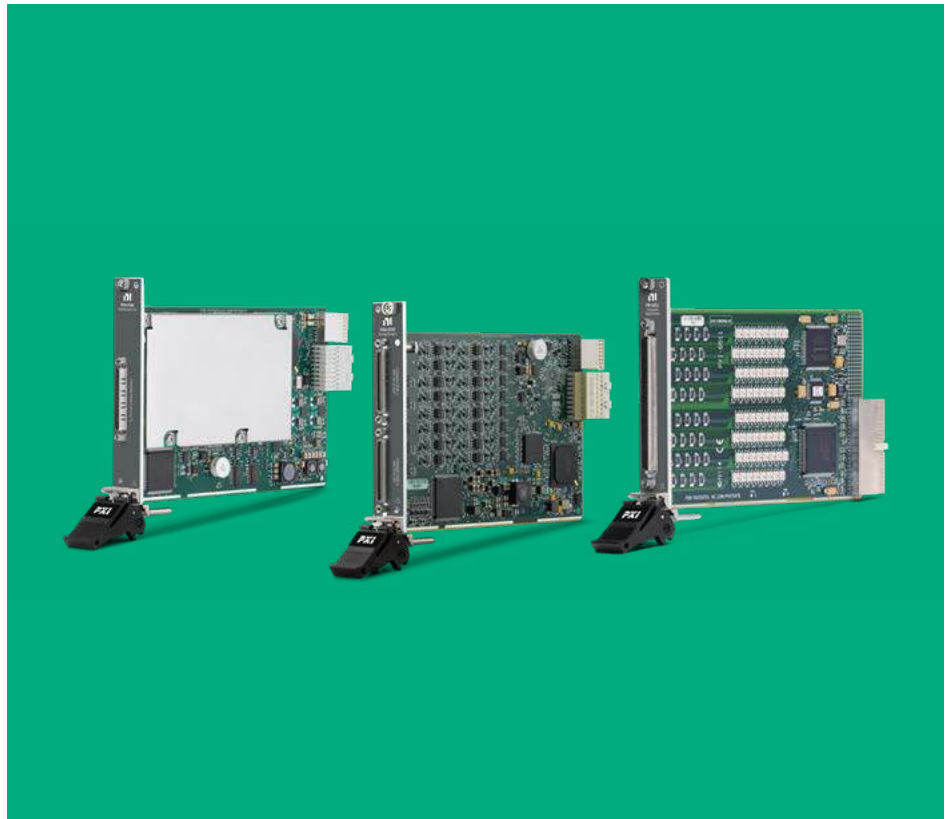

Recommended software (sold separately):

 LabVIEW

Additional resources for software development:

C/C++, C#, Python,
 LabWindows/CVI

Analog Output Modules

Category	Model	Part Number	Analog Output Resolution	Analog Output Voltage Range	Bus Connector	Max Update Rate	Analog Output Channels	Output Current Range
General Purpose	PXI-6704	777796-01	16 Bits	-10.1 V to 10.1 V	PXI Hybrid	Static	32	0.1 mA to 20.2 mA
Lowest Cost	PXI-6723	778998-01	13 Bits	-10 V to 10 V	PXI Hybrid	800 kS/s	32	—
Fastest Update Rate	PXI-6733	778512-01	16 Bits	-10 V to 10 V	PXI Hybrid	1 MS/s	8	—
	PXIe-6738	783800-01	16 Bits	-10 V to 10 V	PXI Express	1 MS/s	32	—
Highest Channel Count and Fastest Update Rate	PXIe-6739	783801-01	16 Bits	-10 V to 10 V	PXI Express	1 MS/s	64	—

Analog Output Accessories

Connector Block

Model	CB-68LP Connector Block	CB-68LPRI/O Connector Block	SCB-68A Shielded Connector Block	TBX-68 Connector Block	BNC-2110 Noise-Rejecting, Shielded BNC Connector Block
Part Number	777145-01	777145-02	782536-01	777141-01	777643-01
PXI-6704	✓	✓	✓	✓	—
PXI-6723	✓	✓	✓	✓	✓ ¹
PXI-6733	✓	✓	✓	✓	✓
PXIe-6738	✓	✓	✓	✓	—
PXIe-6739	✓	✓	✓	✓	—

¹ Only for connector 0

Cables

Model	Cable Assembly, Type SH6868-D1, 1 m	Cable Assembly, Type SH6868-D1, 2 m	Cable Assembly, Type SH6868-D1, 5 m	Cable Assembly, Type SH6868-D1, 0.4 m	Cable Assembly, Type SH6868-D1, 10 m	Kit, Cable Assembly, 2X 68-Pos Series D-Type, Type SH68-68-EPM, 1 m	Kit, Cable Assembly, 2X 68-Pos Series D-Type, Type SH68-68-EPM, 2 m
Part Number	183432-01	183432-02	183432-05	183432-0R4	183432-10	199006-01	199006-02
PXI-6704	✓	✓	✓	✓	✓	—	—
PXI-6723	—	—	—	—	—	—	—
PXI-6733	—	—	—	—	—	✓	✓
PXIe-6738	—	—	—	—	—	—	—
PXIe-6739	—	—	—	—	—	—	—

Cables (continued)

Model	Kit, Cable Assembly, 2X 68-Pos Series D-Type, Type SH68-68-EPM, 5 m	SH68-68-EPM Shielded Cable, 68 D-Type To 68 D-Type, 0.25 m	SH68-68-EPM Shielded Cable, 68 D-Type To 68 D-Type, 0.35 m	Kit, Cable Assembly, 2X 68-Pos Series D-Type, Type SH68-68-EPM, .5 m	Kit, Cable Assembly, 2X 68-Pos Series D-Type, Type SH68-68-EPM, 10 m	RC68-68 Ribbon Cable, 68 D-Type to 68 VHDCI Offset, 1 m	RC68-68 Ribbon Cable, 68 D-Type to 68 VHDCI Offset, .25 m
Part Number	199006-05	199006-0R25	199006-0R35	199006-0R5	199006-10	187252-01	187252-0R25
PXI-6704	—	—	—	—	—	—	—
PXI-6723	—	—	—	—	—	✓	✓
PXI-6733	✓	✓	✓	✓	✓	—	—
PXIe-6738	—	—	—	—	—	✓	✓
PXIe-6739	—	—	—	—	—	✓	✓

Cables (continued)

Model	RC68-68 Ribbon Cable, 68 D-Type to 68 VHDCI Offset, .5 m	SHC68-68-A2, 68-Pin Male VHDCI to 68-Pin Female SCSI, 1 m Cable	SHC68-68-A2, 68-Pin Male VHDCI to 68-Pin Female SCSI, 2 m Cable	SHC68-68-A2, 68-Pin Male VHDCI to 68-Pin Female SCSI, 0.5 m Cable	SH68-C68-S, 68 Pin VHDCI To 68 Pin 0.05 Series D-Type 1 m	SH68-C68-S, 68 Pin VHDCI To 68 Pin 0.05 Series D-Type 0.5 m	SH68-C68-S, 68 Pin VHDCI To 68 Pin 0.05 Series D-Type SH68-C68-S 2 m
Part Number	187252-0R5	157599-01	157599-02	157599-0R5	186381-01	186381-0R5	186381-02
PXI-6704	—	—	—	—	—	—	—
PXI-6723	✓	—	—	—	✓	✓	✓
PXI-6733	—	—	—	—	—	—	—
PXIe-6738	✓	✓	✓	✓	—	—	—
PXIe-6739	✓	✓	✓	✓	—	—	—

Digital I/O Modules

Category	Model	Part Number	Bus Connector	Digital I/O Logic Levels	Digital Input Voltage Range	Max Clock Rate	Bidirectional Digital Channels	Digital Input-Only Channels	Digital Output-Only Channels	Output Voltage Range	Signaling Type	Single-Ended Digital I/O Channel
30 V High-Channel DI	PXI-6511	778967-01	PXI Hybrid	24 V	-30 V to 30 V	—	—	64	—	—	Single-Ended	—
30 V High-Channel DO	PXI-6512	778969-01	PXI Hybrid	24 V	—	—	—	—	64	0 V to 30 V	Single-Ended	350 mA
30 V Sink/Source DI, Source DO	PXI-6514	778965-01	PXI Hybrid	24 V	-30 V to 30 V	—	—	32	32	-30 V to 30 V	Single-Ended	350 mA
Highest-Channel Current Drive (475 mA), 32 DI, 32 DO	PXI-6515	778964-01	PXI Hybrid	24 V	-30 V to 30 V	—	—	32	32	-30 V to 30 V	Single-Ended	475 mA
60 V Sink/Source DI/DO; Channel-Channel Isolated	PXI-6528	778543-01	PXI Hybrid	60 V	-60 V to 60 V	—	—	24	24	-60 V to 60 V	Single-Ended	150 mA
Lowest Cost	PXIe-6509	787358-01	PXI Express	5 V	0 V to 5 V	—	96	0	0	0 V to 5.5 V	Single-Ended	24 mA
Programmable Logic Level	PXIe-6535	780695-0	PXI Express	2.5 V 3.3 V 5 V TTL	-1 V to 6 V	10 MHz	32	—	—	0 V to 5 V	Single-Ended	32 mA

Digital I/O Accessories

Connector Block

Connector Blocks	CB-50 I/O Connector Without Cable	CB-50LP Connector Block Without Cable	SCB-100A Noise-Rejecting, Shielded I/O Connector Block	CB-68LP Connector Block	SCB-68A Shielded Connector Block	TBX-68 Connector Block
Part Number	776164-90	777101-01	785024-01	777145-01	782536-01	777141-01
PXI-6511	✓	✓	✓	—	—	—
PXI-6512	✓	✓	✓	—	—	—
PXI-6514	✓	✓	✓	—	—	—
PXI-6515	✓	✓	✓	—	—	—
PXI-6528	✓	✓	✓	—	—	—
PXIe-6509	✓	✓	✓	—	—	—
PXIe-6535	—	—	—	✓	✓	✓

Cables

Cables	Cable Assembly, 100 Pos, .050 Series D-Type to 2X 50 Pos, Type R1005050, 1 m	Cable Assembly, 100 Pos, .050 Series D-Type to 2X 50 Pos, Type R1005050, 2 m	Cable Assembly, 100 Pos, .050 Series D-Type to 2X 50 Pos, Type R1005050, .5 m	Cable Assembly, 2 X 100-Pos .0 50 Series D-Type, Shielded, Flex Motion, Type SH 100 m-100 m Flex, 1 m	Cable Assembly, 2 X 100-Pos .050 Series D-Type, Shielded, Flex Motion, Type SH 100 m-100 m Flex, 2 m (4150-0008)	C68-C68-D4 Unshielded Cable For High-Speed Digital I/O, 2X 68-Position VHDCI Offset, 1 m	SHC68-C68-D4 Shielded Single-Ended Cable, Lower DC Resistance, 3 m
Part Number	182762-01	182762-02	182762-0R5	185095-01	185095-02	195949-01	132625-03
PXI-6511	✓	✓	✓	✓	✓	—	—
PXI-6512	✓	✓	✓	✓	✓	—	—
PXI-6514	✓	✓	✓	✓	✓	—	—
PXI-6515	✓	✓	✓	✓	✓	—	—
PXI-6528	✓	✓	✓	✓	✓	—	—
PXIe-6509	✓	✓	✓	✓	✓	—	—
PXIe-6535	—	—	—	—	—	✓	✓

Cables (continued)

Cables	SHC68-C68-D4 Shielded Single-Ended Cable, Low Leakage, 1 m	SHC68-C68-D4 Shielded Single-Ended Cable, 1 m	SHC68-C68-D4 Shielded Single-Ended Cable, 0.55 m	SHC68-C68-D4 Shielded Single-Ended Cable, 2 m
Part Number	152870-01	196275-01	781013-01	781293-01
PXI-6511	—	—	—	—
PXI-6512	—	—	—	—
PXI-6514	—	—	—	—
PXI-6515	—	—	—	—
PXI-6528	—	—	—	—
PXIe-6509	—	—	—	—
PXIe-6535	✓	✓	✓	✓

Multifunction I/O Modules

Category	Model	Part Number	Analog Input Absolute Accuracy	Analog Input FIFO Buffer Size	Analog Input Resolution	Max Number of Differential Analog	Max Number of Single-Ended Analog	Max Sample Rate	Max Update Rate	Channels
High Channel Count	PXIe-6345	783631-01	1,520 μ V	4,095 Samples	16 Bits	40	80	500 kS/s	2.86 MS/s	Analog Output: 2 Bidirectional Digital: 24
	PXIe-6355	783632-01	1,520 μ V	4,095 Samples	16 Bits	40	80	1.25 MS/s	2.86 MS/s	Analog Output: 2 Bidirectional Digital: 24
	PXIe-6365	783633-01	1,520 μ V	4,095 Samples	16 Bits	72	144	2 MS/s	2.86 MS/s	Analog Output: 2 Bidirectional Digital: 24
	PXIe-6375	783634-01	1,660 μ V	4,095 Samples	16 Bits	104	208	3.86 MS/s	2.86 MS/s	Analog Output: 2 Bidirectional Digital: 24
General Purpose	PXIe-6363	781056-01	1,660 μ V	2,047 Samples	16 Bits	16	32	2 MS/s	2.86 MS/s	Analog Output: 4 Bidirectional Digital: 48
	PXIe-6361	781055-01	1,660 μ V	2,047 Samples	16 Bits	8	16	2 MS/s	2.86 MS/s	Analog Output: 2 Bidirectional Digital: 24
	PXIe-6341	781052-01	2,190 μ V	2,047 Samples	16 Bits	8	16	500 kS/s	900 kS/s	Analog Output: 2 Bidirectional Digital: 24
Simultaneous Sampling	PXIe-6366	781057-01	2,688 μ V	8,182 Samples	16 Bits	8	0	2 MS/s/ch	3.3 MS/s/ch	Analog Output: 2 Bidirectional Digital: 24
	PXIe-6368	781058-01	2,688 μ V	8,182 Samples	16 Bits	16	0	2 MS/s/ch	3.3 MS/s/ch	Analog Output: 4 Bidirectional Digital: 48
	PXIe-6376	781475-01	2,688 μ V	8,182 Samples	16 Bits	8	0	3.57 MS/s/ch	3.3 MS/s/ch	Analog Output: 2 Bidirectional Digital: 24
	PXIe-6378	781476-01	2,688 μ V	12,268 Samples	16 Bits	16	0	3.57 MS/s/ch	3.3 MS/s/ch	Analog Output: 4 Bidirectional Digital: 48
	PXIe-6356	781053-01	2,688 μ V	8,182 Samples	16 Bits	8	0	1.25 MS/s/ch	3.3 MS/s/ch	Analog Output: 2 Bidirectional Digital: 24
	PXIe-6358	781054-01	2,688 μ V	8,182 Samples	16 Bits	16	0	1.25 MS/s/ch	3.3 MS/s/ch	Analog Output: 4 Bidirectional Digital: 48
	PXIe-6124	780536-01	3,147 μ V	16382 Samples	16 Bits	4	0	4 MS/s/ch	4 MS/s/ch	Analog Output: 2 Bidirectional Digital: 24
	PXIe-6349	785808-01	3,225 μ V	4,095 Samples	16 Bits	32	0	500 kS/s/ch	900 kS/s	Analog Output: 2 Bidirectional Digital: 24
Highest-Rate Simultaneous Sampling	PXIe-6386	785926-01	1,769 μ V	8,182 Samples	16 Bits	8	0	14 MS/s/ch	3.3 MS/s/ch	Analog Output: 2 Bidirectional Digital: 24
	PXIe-6396	785927-01	1,769 μ V	8,182 Samples	18 Bits	8	0	14 MS/s/ch	3.3 MS/s/ch	Analog Output: 2 Bidirectional Digital: 24

Multifunction I/O Accessories

Cables

Cables	RC68-68 Ribbon Cable, 68 D-Type To 68 VHDCI Offset, 1 m	RC68-68 Ribbon Cable, 68 D-Type To 68 VHDCI Offset, .25 m	RC68-68 Ribbon Cable, 68 D-Type To 68 VHDCI Offset, .5 m	SHC68-68, Twisted Pair Cable With Basic Shielding, 1 m	SHC68-68, Twisted Pair Cable With Basic Shielding, 2 m
Part Number	187252-01	187252-0R25	187252-0R5	191945-01	191945-02
PXIe-6124	✓	✓	✓	✓	✓
PXIe-6341	✓	✓	✓	✓	✓
PXIe-6345	✓	✓	✓	✓	✓
PXIe-6349	✓	✓	✓	✓	✓
PXIe-6355	✓	✓	✓	✓	✓
PXIe-6356	✓	✓	✓	✓	✓
PXIe-6358	✓	✓	✓	✓	✓
PXIe-6361	✓	✓	✓	✓	✓
PXIe-6363	✓	✓	✓	✓	✓
PXIe-6365	✓	✓	✓	✓	✓
PXIe-6366	✓	✓	✓	✓	✓
PXIe-6368	✓	✓	✓	✓	✓
PXIe-6375	✓	✓	✓	✓	✓
PXIe-6376	✓	✓	✓	✓	✓
PXIe-6378	✓	✓	✓	✓	✓
PXIe-6386	✓	✓	✓	✓	✓
PXIe-6396	✓	✓	✓	✓	✓

Cables (continued)

Cables	SHC68-68, Twisted Pair Cable With Basic Shielding, 0.5 m	SHC68-68-EPM Shielded Cable, 68-Position .050 Series D-Type to 68-Pos VHDCI Offset, 1 m	SHC68-68-EPM Shielded Cable, 68-Position .050 Series D-Type to 68-Pos VHDCI Offset, 2 m	SHC68-68-EPM Shielded Cable, 68-Position .050 Series D-Type to 68-Pos VHDCI Offset, 5 m	SHC68-68-EPM Shielded Cable, 68-Position .050 Series D-Type to 68-Pos VHDCI Offset, .5 m	SHC68-68-EPM Shielded Cable, 68-Position .050 Series D-Type to 68-Pos VHDCI Offset, 10 m
Part Number	191945-0R5	192061-01	192061-02	192061-05	192061-0R5	192061-10
PXIe-6124	✓	✓	✓	✓	✓	✓
PXIe-6341	✓	✓	✓	✓	✓	✓
PXIe-6345	✓	✓ ¹	✓ ¹	✓ ¹	✓ ¹	✓ ¹
PXIe-6349	—	—	—	—	—	—
PXIe-6355	✓	✓ ¹	✓ ¹	✓ ¹	✓ ¹	✓ ¹
PXIe-6356	✓	✓	✓	✓	✓	✓
PXIe-6358	✓	✓	✓	✓	✓	✓
PXIe-6361	✓	✓	✓	✓	✓	✓
PXIe-6363	✓	✓	✓	✓	✓	✓
PXIe-6365	✓	✓ ¹	✓ ¹	✓ ¹	✓ ¹	✓ ¹
PXIe-6366	✓	✓	✓	✓	✓	✓
PXIe-6368	✓	✓	✓	✓	✓	✓
PXIe-6375	✓	✓ ¹	✓ ¹	✓ ¹	✓ ¹	✓ ¹
PXIe-6376	✓	✓	✓	✓	✓	✓
PXIe-6378	✓	✓	✓	✓	✓	✓
PXIe-6386	✓	✓	✓	✓	✓	✓
PXIe-6396	✓	✓	✓	✓	✓	✓

¹ Only for connector 0

Connector Block

Connector Blocks	CB-68LP Connector Block	CB-68LPR I/O Connector Block	SCB-68A Shielded Connector Block	TBX-68 Connector Block	BNC-2111 Single-Ended, Shielded BNC Connector Block	BNC-2110 Noise-Rejecting, Shielded BNC Connector Block	BNC-2120 Shielded BNC Connector Block With Onboard Function Generator and Quadrature Encoder	BNC-2115 Noise Rejecting, Shielded BNC Connector Block For Extended I/O	BNC-2090A Rack-Mountable Accessory For 68-Pin Multifunction DAQ
Part Number	777145-01	777145-02	782536-01	777141-01	779347-01	777643-01	777960-01	777807-01	779556-01
PXIe-6124	✓	✓	✓	✓	—	✓	✓	—	✓
PXIe-6341	✓	✓	✓	✓	—	✓	—	—	✓
PXIe-6345	✓	✓	✓	✓	—	✓	—	—	✓
PXIe-6349	✓	✓	✓	✓	—	✓ ¹	—	—	✓ ¹
PXIe-6355	✓	✓	✓	✓	—	✓	—	—	✓
PXIe-6356	✓	✓	✓	✓	—	✓	—	—	✓
PXIe-6358	✓	✓	✓	✓	—	✓	—	—	✓
PXIe-6361	✓	✓	✓	✓	—	✓	—	—	✓
PXIe-6363	✓	✓	✓	✓	✓	✓	✓	—	✓
PXIe-6365	✓	✓	✓	✓	—	✓ ²	—	—	✓ ²
PXIe-6366	✓	✓	✓	✓	—	✓	—	—	✓
PXIe-6368	✓	✓	✓	✓	✓	✓	✓	—	✓
PXIe-6375	✓	✓	✓	✓	—	—	—	✓	—
PXIe-6376	✓	✓	✓	✓	—	✓	✓	—	✓
PXIe-6378	✓	✓	✓	✓	—	✓	✓	—	✓
PXIe-6386	✓	✓	✓	✓	—	✓	✓	—	✓
PXIe-6396	✓	✓	✓	✓	—	✓	✓	—	✓

¹ Only for connector 0

² Only for connector 0 and 1

RF



As we push the boundaries of wireless communications, NI offers software defined radios, generators, analyzers, and transceivers for rapid prototyping and production test.



Recommended software (sold separately):

 LabVIEW

 RFmx

 InstrumentStudio Professional

Additional resources for software development:

 InstrumentStudio

Vector Signal Transceivers

- Generate and acquire wide instantaneous bandwidth
- Ensure test coverage for new and legacy wireless standards
- Achieve better than -50 dB EVM performance for higher-order modulation schemes

Key Features:

Test High Frequency and Wide Instantaneous Bandwidth

With frequency coverage from baseband to mmWave and up to 2 GHz instantaneous bandwidth, Vector Signal Transceivers (VSTs) are ideally suited for carrier aggregation, digital predistortion, and radar testing.

Perform Fast and Accurate EVM Measurements

Low phase noise, high linearity, and patented IQ calibration combine to achieve best-in-class EVM performance with higher-order modulation schemes.

Optimize RF Front-End Validation

Easy-to-use and customizable DPD algorithms and up to 2 GHz of instantaneous RF bandwidth translate to quick and easy DPD implementation in RFIC characterization.

Vector Signal Transceiver Modules

Selection Guide	Model	Part Number	I/O Type	Module Width	Frequency Range	Instantaneous Bandwidth	EVM (5G NR 100 MHz, Loopback @ 5.5 GHz)	Tuning Time	P2P Streaming
High-Performance RF	PXIe-5842	789600-26211	RF In, RF Out, or Both	4 Slots	30 MHz–26.5 GHz	2 GHz	-58 dB	230 μ s	Yes, up to 1 GHz
	PXIe-5842	789600-18211			30 MHz–18 GHz	2 GHz			
	PXIe-5842	789600-12211			30 MHz–12 GHz	2 GHz			
	PXIe-5842	789600-08211			30 MHz–8 GHz	2 GHz			
	PXIe-5842	789600-08111			30 MHz–8 GHz	1 GHz			
	PXIe-5842	789600-12111			30 MHz–12 GHz	1 GHz			
	PXIe-5842	789600-08511			30 MHz–8 GHz	500 MHz			
	PXIe-5842	789600-12511			30 MHz–12 GHz	500 MHz			
	PXIe-5842	788566-02	RF In and RF Out	6 Slots	200 MHz–23 GHz, 22.5 GHz–54 GHz	2 GHz			
Sub-6 GHz	PXIe-5841	786982-01	RF In and RF Out	2 Slots	9 kHz–6 GHz	1 GHz	-49 dB	380 μ s	Yes, up to 1 GHz
	PXIe-5841	785832-01		3 Slots				175 μ s	
mmWave, Built-In Switching	PXIe-5831	786856-01	RF In and RF Out	6 Slots	5 GHz–31.3 GHz, 37 GHz–44 GHz	1 GHz	-51 dB	500 μ s	Yes, up to 1 GHz
IF	PXIe-5831	786853-01		4 Slots	5 GHz–21 GHz				
Baseband	PXIe-5820	783967-01	I/Q In and I/Q Out	2 Slots	DC–500 MHz	1 GHz	N/A	380 μ s	Yes, up to 1 GHz

* See [RF Module Accessories](#)



Recommended software (sold separately):

- LabVIEW
- RFmx
- InstrumentStudio Professional

Additional resources for software development:

- C/C++, .NET
- LabWindows/CVI
- InstrumentStudio

Vector Network Analyzers

- Single-slot 26.5 GHz 2-port VNA with pass-through mode for VSG and VSA testing at VNA ports
- Combined VST and VNA simplifies large and small signal testing to one test insertion
- Vector Calibration Module for automated 1-port and 2-port S-parameter calibrations
- Software support with RFmx VNA and InstrumentStudio™ software

Key Features:

Single-Connection Modulation Analysis and S-Parameter Testing

Pair the latest NI VNA and VST to integrate both S-parameter and modulation measurements into a DUT test plan without complex switching setups.

Simplified Calibration Process

Simplify calibration using an electronic vector calibration module for easy and convenient S-parameter calibration.

Powerful Software

RFmx is a set of interoperable measurement personalities together with waveform creation software that extends the capability of NI RF instrumentation for general-purpose, connectivity, cellular, and aerospace and defense test applications.

Vector Network Analyzers Modules

Selection Guide	Model	Part Number	Frequency Range	Ports	Dynamic Range (Typical)	Maximum Source Power (Typical)	Corrected Directivity
High-Performance S-Parameter Capability	PXIe-5633	788182-26	50 MHz-26.5 GHz	2	125 dB (> 22 GHz to 26.5 GHz) 134 dB (> 18 GHz to 22 GHz) 137 dB (> 8 GHz to 18 GHz) 138 dB (> 6 GHz to 8 GHz) 146 dB (> 300 MHz to 6 GHz) 134 dB (100 MHz to 300 MHz)	+5 dBm (> 22 GHz to 26.5 GHz) +10 dBm (> 18 GHz to 22 GHz) +13 dBm (> 12 GHz to 18 GHz) +15 dBm (> 8 GHz to 12 GHz) +16 dBm (> 6 GHz to 8 GHz) +18 dBm (50 MHz to 6 GHz)	≥ 39 dB (> 20 GHz to 26.5 GHz) ≥ 40 dB (> 12 GHz to 20 GHz) ≥ 41 dB (> 8 GHz to 12 GHz) ≥ 42 dB (100 MHz to 8 GHz)
		788182-18	50 MHz-18 GHz	2	137 dB (> 8 GHz to 18 GHz) 138 dB (> 6 GHz to 8 GHz) 146 dB (> 300 MHz to 6 GHz) 134 dB (100 MHz to 300 MHz)	+13 dBm (> 12 GHz to 18 GHz) +15 dBm (> 8 GHz to 12 GHz) +16 dBm (> 6 GHz to 8 GHz) +18 dBm (50 MHz to 6 GHz)	≥ 40 dB (> 12 GHz to 20 GHz) ≥ 41 dB (> 8 GHz to 12 GHz) ≥ 42 dB (100 MHz to 8 GHz)
		788182-12	50 MHz-12 GHz	2	138 dB (> 6 GHz to 8 GHz) 146 dB (> 300 MHz to 6 GHz) 134 dB (100 MHz to 300 MHz)	+15 dBm (> 8 GHz to 12 GHz) +16 dBm (> 6 GHz to 8 GHz) +18 dBm (50 MHz to 6 GHz)	≥ 41 dB (> 8 GHz to 12 GHz) ≥ 42 dB (100 MHz to 8 GHz)
		788182-08	50 MHz-8 GHz	2	138 dB (> 6 GHz to 8 GHz) 146 dB (> 300 MHz to 6 GHz) 134 dB (100 MHz to 300 MHz)	+16 dBm (> 6 GHz to 8 GHz) +18 dBm (50 MHz to 6 GHz)	≥ 42 dB (100 MHz to 8 GHz)

RF Module Accessories

VST and VNA Accessories

Selection Guide	Cable Part Number	Length	Back-End Connection	Front-End Connection	Max Frequency	Description	Model Compatibility
High Performance, Temperature-Stable	136692-1000	1,000 mm	2.92 mm (Male)	2.92 mm (Male)	26.5 GHz	Phase stability over temperature for wideband and some VNA applications. Lower insertion loss.	PXIe-5842 PXIe-5841 PXIe-5831 PXIe-5633
	136692-0650	650 mm					
Temperature-Stable	136691-0870	870 mm	SMA (Male)	SMA (Male)	26.5 GHz	Phase stability over temperature for wideband and some VNA applications. Higher insertion loss.	PXIe-5842 PXIe-5841 PXIe-5831 PXIe-5633
	136691-0670	670 mm					
	136691-0400	400 mm					
High Performance, Phase-Stable for VNA Applications	137445-01	1,000 mm	3.5 mm (Male)	3.5 mm (Male)	26.5 GHz	Phase stable measurements (S-parameters). Best performance.	PXIe-5842 PXIe-5841 PXIe-5831 PXIe-5633
Phase-Stable for VNA Applications	137446-03	3,000 mm	3.5 mm (Male)	3.5 mm (Male)	26.5 GHz	Phase stable measurements (S-parameters). Higher flexibility.	PXIe-5842 PXIe-5841 PXIe-5831 PXIe-5633
	137446-01	1,000 mm					
Low Cost	137833-1000	1,000 mm	SMA (Male)	SMA (Male)	26.5 GHz	Suitable for most configurations needing 26 GHz. Low cost.	PXIe-5842 PXIe-5841 PXIe-5831 PXIe-5633
	137833-0600	600 mm					
	137833-0300	300 mm					
	137833-0150	150 mm					
Rated for mmWave Applications	138286-1000	1,000 mm	1.85 mm (Male)	1.85 mm (Male)	67 GHz	High-performance, suitable for mmWave applications.	PXIe-5842 PXIe-5831

VNA Calibration Kits and Accessories

Selection Guide	Model	Part Number	Number of Ports	Frequency Coverage	Calibration Method
Electronic Vector Calibration Module	CAL-5501*	788189-01	2	50 MHz – 26.5 GHz	Short, Open, Load (SOL) and Short, Open, Load, Through (SOLT)

*For Use with PXIe-5633 VNA Only



Recommended software (sold separately):

▶ LabVIEW®

Additional resources for software development:

C/C++, Python, VHDL/Verilog, UHD/RfNoC

Software Defined Radios

- 1 MHz to 7.2 GHz frequency ranges (tunable up to 8 GHz)
- Up to 1.6 GHz/channel of bandwidth
- Up to eight transmit and eight receive channels per radio
- Development tools such as LabVIEW, open-source UHD, GNU Radio, and MathWorks MATLAB® software

Key Features:

Build Advanced Wireless Systems

Modern wireless systems require a new generation of software defined radios (SDRs) for prototyping and deployment. Systems need wider bandwidth, higher frequencies, and more advanced digital signal-processing architectures. Explore how the latest USRP (Universal Software Radio Peripheral) options offer enhanced performance to build your next advanced wireless prototype.

Prototype with Wider Bandwidth

Prototyping algorithms for applications such as radar research requires the need for wider bandwidths and more channels. At up to 1.6 GHz of bandwidth and eight transmit and receive channels, the NI Ettus USRP X440 achieves higher accuracy for direction-finding while maintaining phase coherency.

Use the Software of Your Choice

No matter your development tool preferences, you can be confident in USRP hardware, which is compatible with the broadest range of software workflows on the market. You can choose LabVIEW for a unified dataflow programming style, or use the open-source driver with support for C, C++, MathWorks MATLAB®, GNU Radio, and more.

Software Defined Radio Modules

Selection Guide	NI Model	NI Ettus Model	Part Number	#TX	#RX	Frequency Range	Bandwidth
Stand-Alone, FPGA-Enabled, High Performance	USRP X440	USRP X440	788670-01	8	8	30 MHz—4 GHz	1.6 GHz
	USRP X410	USRP X410	787272-01	4	4	1 MHz—7.2 GHz	400 MHz
	—	USRP N320	786503-01	2	2	3 MHz—6 GHz	200 MHz
	—	USRP N321	786504-01				
	—	USRP N310	785067-01	4	4	10 MHz—6 GHz	100 MHz
USRP-2974	N/A	785606-01	2	2	10 MHz—6 GHz	160 MHz	
Host-Connected, FPGA-Enabled, High Performance	USRP-2944	USRP X310 + UBX	783149-01	2	2	30 MHz—6 GHz	160 MHz
	USRP-2945	USRP X310 + TwinRx	785263-01	0	4	10 MHz—6 GHz	80 MHz
	USRP-2954	USRP X310 + UBX + GPSDO	783153-01	2	2	30 MHz—6 GHz	160 MHz
	USRP-2955	USRP X310 + TwinRx + GPSDO	785264-01	0	4	10 MHz—6 GHz	80 MHz
Low Size, Weight, and Power (SWAP), Stand-Alone, Embedded	—	USRP E310	783773-01	2	2	70 MHz—6 GHz	56 MHz
		USRP E313 (Rugged and Weatherproof)	784583-01				
		USRP E320 (Larger FPGA)	786189-01				
Low SWAP, Low Cost, USB-Connected	—	USRP B200mini-i	785889-01	1	1	70 MHz—6 GHz	56 MHz
		USRP B205mini-i (Larger FPGA)	785888-01				
	USRP-2900	USRP B200	784039-01	1	1	70 MHz—6 GHz	56 MHz
	USRP-2901	USRP B210	784040-01	2	2	70 MHz—6 GHz	56 MHz

Software Defined Radio Accessories

USRP Power Cables

Part Description	EMI Suppression Ferrite, 13.05 mm	Power Cord for USRP RIO, Australia	Power Cord for USRP RIO, China	Power Cord for USRP RIO, Europe	Power Cord for USRP RIO, Japan	Power Cord for USRP RIO, Korea	Power Cord for USRP RIO, UK	Power Cord for USRP RIO, US	International Power Cords for USRP RIO
Part Number	784968-01	785023-03	785023-10	785023-04	785023-07	785023-09	785023-06	785023-01	783490-01
USRP X440	✓	✓	✓	✓	✓	✓	✓	✓	✓
USRP X410	✓	✓	✓	✓	✓	✓	✓	✓	✓
USRP 2955	✓	✓	✓	✓	✓	✓	✓	✓	—
USRP 2954	✓	✓	✓	✓	✓	✓	✓	✓	—
USRP 2945	✓	✓	✓	✓	✓	✓	✓	✓	—
USRP 2974	✓	✓	✓	✓	✓	✓	✓	✓	—
USRP N321	✓	✓	✓	✓	✓	✓	✓	✓	—
USRP N320	✓	✓	✓	✓	✓	✓	✓	✓	—
USRP N310	✓	✓	✓	✓	✓	✓	✓	✓	—

RF Cables

Part Description	Kit for USRP Systems Includes Two SMA-M to SMA-M Cables (1 m) and Two SMA-F to SMA-M Attenuators (30 dB, 50 Ω, DC-6 GHz)	One SMA-M to SMA-M Cable, New Low-Loss Coax Good to 6 GHz, 1 m
Part Number	782781-01	783469-01
USRP X440	—	—
USRP X410	✓	✓
USRP 2955	✓	✓
USRP 2954	✓	✓
USRP 2945	✓	✓
USRP 2974	✓	✓
USRP N321	✓	✓
USRP N320	✓	✓
USRP N310	✓	✓
USRP 2900	✓	✓
USRP 2901	✓	✓
USRP B200mini/B205mini	✓	✓

USRP X4XX Accessories

Part Description	USRP X4XX 19" Rack-Mount Accessory, 1U, 1 USRP X4XX Device, w/ Surrogate Extension	USRP X4XX 19" Rack-Mount Accessory, 1U, 2 USRP X4XX Devices, Shoulder to Shoulder	USRP X4XX Desktop Stack Accessory, Single USRP X4XX Device Fastened Buildup	USRP X4XX Fan Cartridge Accessory, Exhaust	USRP X4XX Fan Cartridge Accessory, Intake
Part Number	788149-01	788147-01	788148-01	788164-01	788165-01
USRP X440	✓	✓	✓	✓	✓
USRP X410	✓	✓	✓	✓	✓

USRP X4XX Accessories (continued)

Part Description	Dual 100 Gigabit Ethernet PCIe Interface Kit for Ettus USRP X4XX	SHH19-H19-AUX Shielded Single-Ended Cable for AUX Digital I/O with Jackscrew, 2 m	PCIe Gen3 Interface Kit for Ettus USRP X4XX (Desktop)	QSFP28 to 4XSFP28 Breakout Cable, 1 m	QSFP28 Twinaxial Cable, 3 m	SCB-19 Noise-Rejecting, Shielded Auxiliary I/O Connector Block
Part Number	788216-01	152629-02	788264-01	788214-01	788215-03	782444-01
USRP X440	✓	✓	✓	✓	✓	✓
USRP X410	✓	—	✓	✓	✓	—

USRP RIO Accessories

Part Description	PCIe-MXI Express Interface Kit for USRP RIO	PXIe-MXI Express Interface Kit for USRP RIO	SFP+ Cable, 1 m	GPIO Connection Kit for USRP RIO
Part Number	783487-01	783488-01	784076-01	783491-01
USRP 2974	✓	✓	✓	✓
USRP 2955	✓	✓	—	—
USRP 2954	✓	✓	—	—
USRP 2945	✓	✓	—	—
USRP 2944	✓	✓	—	—

Software Defined Radio Accessories

Clocking Accessories

Part Description	OctoClock-G CDA-2990	OctoClock CDA-2990	GPSDO Kit for USRP N200/N210	Board-Mounted GPSDO (TCXO) Recommended for USRP B200/B210	Board-Mounted GPSDO (OCXO) Recommended for USRP X300/X310
Part Number	784306-01	784305-01	782779-01	783454-01	783173-01
USRP X4xx	✓	✓	—	—	—
USRP X3xx	✓	✓	—	—	✓
USRP N3xx	✓	✓	—	—	—
USRP 294x	✓	✓	—	—	✓
USRP 295x	✓	✓	—	—	included
USRP B2xx, 2900	✓	✓	—	✓	—
USRP N2xx	✓	✓	✓	—	—

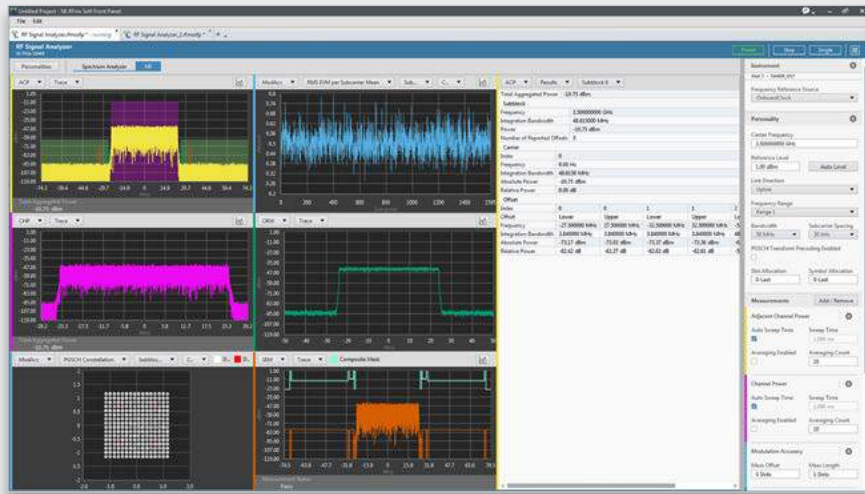

NI RFmx

RFmx is a set of interoperable software applications that optimize NI RF instrumentation for general-purpose, cellular, connectivity, and aerospace/defense test applications. RFmx simplifies your signal generation and measurement experience.

Key Features:

Standard-Compliant

Test multiple wireless standards for cellular, connectivity, and IoT signals. Select the personality of RFmx for your specific application and testing needs.

Quicker Start

Begin measurement out of the box with interactive soft front panels and, with waveform creation software, generate and modify unlocked waveforms.

Faster Execution

Complete testing quicker by taking advantage of innate high-speed measurement algorithms and composite measurement functionality.

Instrument Control

Too often, powerful box instruments are left on the shelf collecting dust because they communicate using outdated interfaces like serial and GPIB. NI instrument-control hardware can connect these instruments to your laptop or desktop using USB, Ethernet, or PCI Express. Take advantage of thousands of ready-to-use instrument drivers that make it easy to control your instruments using LabVIEW.

Instrument Connection	Form Factor	Notes	Model Name
GPIB	Ethernet	—	GPIB-ENET/1000
GPIB	RS232	—	GPIB-RS232
GPIB	USB 2.0	—	GPIB-USB-HS
GPIB	USB 2.0	Onboard GPIB Analyzer	GPIB-USB-HS+
GPIB	PCI Express	—	PCIe-GPIB
GPIB	PCI Express	Onboard GPIB Analyzer	PCIe-GPIB+
RS232	PCI Express	2 Channels	PCIe-8430/2
RS232	PCI Express	8 Channels	PCIe-8430/8
RS232	PCI Express	16 Channels	PCIe-8430/16
RS485, RS422	PCI Express	2 Channels	PCIe-8431/2
RS485, RS422	PCI Express	8 Channels	PCIe-8431/8
RS485, RS422	PCI Express	16 Channels	PCIe-8431/16
RS232	PCI Express	2 Channels, Port-Port Isolation	PCIe-8432
RS485, RS422	PCI Express	2 Channels, Port-Port Isolation	PCIe-8433
RS232	USB 2.0	1, 2, and 4 Channels	USB-232
RS485, RS422	USB 2.0	1, 2, and 4 Channels	USB-485
RS232	PXI Express	16 Channels	PXIe-8430/16
RS232	PXI Express	8 Channels	PXIe-8430/8
RS485, RS422	PXI Express	16 Channels	PXIe-8431/16
RS485, RS422	PXI Express	8 Channels	PXIe-8431/8
Ethernet	PXI Express	Ethernet bandwidth 25 GB/s	PXIe-8285
Ethernet	PXI Express	Ethernet bandwidth 1 Gbits/s	PXIe-8245
Ethernet	PXI Express	Ethernet bandwidth 40 Gbits/s	PXIe-8240
Ethernet	PXI Express	Ethernet bandwidth 10 Gbits/s	PXIe-8238
Ethernet	PXI Express	Ethernet bandwidth 50 Gbits/s	PXIe-8280
GPIB (IEEE 488) RJ45	PXI	Linux	PXI-GPIB

LabVIEW for Instrument Control

- 7000+ ready-to-run instrument drivers with examples and documentation
- Plug-and-play functionality for popular vendors like Tektronix, Keysight, Keithley, Rohde & Schwarz, and more
- Immediate start with open-and-run examples
- Flexible, scalable software platform to accomplish more with less time, effort, and budget

Visit our Instrument Driver Network ([NI.com/idnet](https://ni.com/idnet)) to download a driver to communicate with third-party instruments.

NI Partner Network

The NI Partner Program offers domain, application, and overall test development expertise to help your team get ahead and stay ahead:

- Innovate faster with proven scalable solutions
- Reduce development time and cost through integration and consulting assistance

Types of Partners



Solution Partners

- Experts in delivering products and solutions to solve your specific automated test or automated measurement application challenges.



System Integrators

- Specialists in integrating and deploying test and measurement systems, based on your specific requirements and their mature industry capabilities.



Consultants

- Experts in project services in areas such as software development, engineering, science, analytics, regulatory compliance, or other specialized skills to support complex systems.



Distributors

- Globally and regionally accessible, authorized distributors with local knowledge and an understanding of the available NI product portfolio, providing a one-stop option for configuring and sourcing your project needs.

Connect with our global community of trusted NI Partners ready to give your business a competitive edge. Find a partner or solution at ni.com/findapartner.





Services

NI offers a variety of services to ensure you can be successful throughout the lifecycle of your application. With global solution centers, NI engineers in more than 40 countries, and a vast network of more than 900 NI Partners, NI service programs help you mitigate risks, develop faster, and reduce costs to achieve your goals.

Hardware Services

From the moment you unbox your hardware to deployment and maintenance, NI hardware services help you get started quickly and operate efficiently throughout the lifecycle of your test system.

Entitlement	Hardware Warranty	Standard	Premium	Description
Duration at Point of Sale	1 Year; Included	3 Years; Optional	3 Years; Optional	NI enhances warranty coverage with additional service benefits provided with a hardware service program.
Maximum Duration with Renewal	≤5 Years with Service Program	≤5 Years	≤5 Years	NI maintains high performance and availability of your hardware for up to 5 years with a hardware service program. For coverage beyond 5 years, NI provides lifecycle service options.
Extended Repair Coverage (3 or 5 years)	✓	✓	✓	NI restores your device's functionality and includes firmware updates and factory calibration.
System Configuration, Assembly, and Test	—	✓	✓	NI technicians assemble, install software on, and test your system per your custom configuration prior to shipment.
Advanced Replacement	—	—	✓	NI stocks replacement hardware that can be shipped immediately if a repair is needed.
System RMA	—	—	✓	NI accepts the delivery of fully assembled systems when performing repair services.
Technical Support	✓	✓	✓	NI provides access to support resources for your hardware.
Calibration Plan (Optional)	—	Standard	Expedited	NI performs the requested level of calibration at a specified calibration interval for the duration of the service program.

Education Services

Education Services incorporate courses and certification programs from NI to help you proficiently develop applications, work with NI hardware, and more. You can apply your knowledge to reduce development time and increase productivity.



Customer Education Courses

Attending on-location or in virtual classrooms and labs, gain knowledge on everything from fundamentals to advanced specifics and become familiar with NI hardware and software.



Training Entitlements

You can gain unique and unlimited access to all NI training courses and certification programs using credits or a training membership.



Certification Program

With certifications from associate developer to architect for LabVIEW and NI TestStand software, you can join the ranks of the thousands of engineers with NI professional certifications.

NI provides flexible options for purchasing training and certification. Whether you want to make an upfront investment or pay as you go, NI meets you at your budgetary needs.

Save money with a training membership

A training membership is a cost-effective way to take multiple instructor-led training courses. This program provides one year of unlimited access to instructor-led training and certification.

Buy credits now, schedule later

Purchase Education Services Credits now and redeem later for any training or certification offering. Education Services Credits expire after one year.

Secure a seat in a public course

View NI's global training calendar and secure a seat in an upcoming virtual or classroom instructor-led course.

Take advantage of on-demand learning

NI software licenses include one-year access to introductory on-demand learning content so you can onboard quickly. Additional on-demand courses are available for purchase.

Organize a private training event

NI offers private training events for teams of up to 12 students. Private training events can leverage standard NI training courses and include custom materials tailored to your needs.

Technical Support Services

With the knowledge, experience, and responsiveness of NI applications engineers in more than 30 languages and 40 countries, NI has the technical support resources to ensure your success.

Access Your NI Standard Technical Support:

Included with Software

- Technical support included with your software subscription license

Included with NI Hardware Warranty

- One year of standard technical support is included with all NI hardware through your hardware warranty



**Ihr Ansprechpartner /
Your Partner:**

dataTec AG
E-Mail: info@datatec.eu
>>> www.datatec.eu

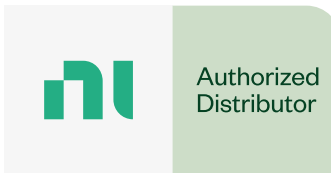

Mess- und Prüftechnik. Die Experten.

Neither Emerson, Emerson Automation Solutions, nor any of their affiliated entities assumes responsibility for the selection, use, or maintenance of any product. Responsibility for proper selection, use, and maintenance of any product remains solely with the purchaser and end user.

Engineer Ambitiously, LabVIEW, CVI, TestStand, DIAdem, FlexLogger, InstrumentStudio, CompactDAQ, CompactRIO, USRP, FlexRIO, and SourceAdapt are marks owned by one of the companies in the Test & Measurement business unit of Emerson Electric Co. Emerson and the Emerson logo are trademarks and service marks of Emerson Electric Co. Thunderbolt and the Thunderbolt logo are trademarks of Intel Corporation or its subsidiaries in the US and/or other countries. MathWorks®, MATLAB®, and Simulink® are registered trademarks of The MathWorks, Inc. The mark LabWindows is used under a license from Microsoft Corporation. Windows is a registered trademark of Microsoft Corporation in the United States and other countries. The registered trademark Linux® is used pursuant to a sublicense from LMI, the exclusive licensee of Linus Torvalds, owner of the mark on a worldwide basis. All other marks are the property of their respective owners. An NI Partner is a business entity independent from NI and has no agency or joint-venture relationship and does not form part of any business associations with NI.

The contents of this publication are presented for informational purposes only, and while every effort has been made to ensure their accuracy, they are not to be construed as warranties or guarantees, express or implied, regarding the products or services described herein or their use or applicability. All sales are governed by our terms and conditions, which are available upon request. We reserve the right to modify or improve the designs or specifications of such products at any time without notice.

NI
11500 N Mopac Expwy
Austin, TX 78759-3504

© 2024 National Instruments. All rights reserved.

Other product and company names listed are trademarks or trade names of their respective companies.

 [Linkedin.com/company/niglobal/](https://www.linkedin.com/company/niglobal/)

 [Twitter.com/NIglobal](https://twitter.com/NIglobal)

 [Youtube.com/@NIGlobalYoutube](https://www.youtube.com/@NIGlobalYoutube)

 [Instagram.com/niglobal/](https://www.instagram.com/niglobal/)

 [Facebook.com/NationalInstruments](https://www.facebook.com/NationalInstruments)