

SELECTING YOUR NEXT OSCILLOSCOPE

Why digital triggering matters

The logo for dataTec, featuring the company name in a white, italicized sans-serif font on a red rectangular background.

Mess- und Prüftechnik. Die Experten.

**Ihr Ansprechpartner /
Your Partner:**

dataTec AG

E-Mail: info@datatec.eu

>>> www.datatec.eu

White paper | Version 01.00

ROHDE & SCHWARZ

Make ideas real



CONTENTS

- 1 Overview**3
- 2 Digital triggering history**4
- 3 Digital versus analog architectures**4
- 4 Digital triggering advantages**5
 - 4.1 Greater trigger sensitivity5
 - 4.2 User hysteresis control6
 - 4.3 Wider range of filters7
 - 4.4 HD mode applied on trigger7
 - 4.5 Interpolation8
 - 4.6 Lower trigger jitter9
- 5 Digital or analog trigger: how to tell?**10
- 6 Conclusion**10

ROHDE & SCHWARZ PRODUCTS

- ▶ R&S®MXO 4 Series oscilloscopes
- ▶ R&S®MXO 5 Series oscilloscopes
- ▶ R&S®RTO6 Series oscilloscopes
- ▶ R&S®RTP Series oscilloscopes

1 OVERVIEW

Your oscilloscope trigger determines the precise moment in time your instrument captures critical events of interest. Triggering is often overlooked as a key selection parameter after the instrument is purchased. Oscilloscopes with superior trigger parameters and functionality provide an edge for development teams to quickly and effectively debug and test. A superior triggering system can save significant time trying to isolate difficult-to-find events, allowing engineers to improve designs more quickly.

Engineers are quick to recognize and compare banner specifications such as bandwidth, record length and sample rate. Comparative assessment of the goodness and quality of oscilloscope triggers can be more elusive. Traditional oscilloscope triggering is based on analog circuitry with the signal being split into a data path and a separate trigger path. Newer oscilloscope architectures contain a single path shared by both signal and triggering. This single path approach is known as digital triggering. Digital triggering has numerous advantages over traditional analog trigger architectures.

This document provides:

- ▶ An explanation of analog versus digital triggering architectures
- ▶ User advantages for oscilloscopes that have digital triggering
- ▶ How to determine if an oscilloscope has a digital or analog trigger



2 DIGITAL TRIGGERING HISTORY

Rohde&Schwarz patented the first methods for oscilloscope digital triggering and used these methods for the first time with the introduction of the R&S®RTO1000 oscilloscope. Digital triggering has become the fundamental implementation in newer Rohde&Schwarz oscilloscopes including the R&S®MXO Series, R&S®RTO6 and R&S®RTP oscilloscopes.

3 DIGITAL VERSUS ANALOG ARCHITECTURES

The vast majority of oscilloscopes in use have analog triggers. Oscilloscopes with analog triggering architectures split the incoming signal into a data path and a separate path for triggering. The trigger circuit is separated from the data path. Users never see the trigger signal on the oscilloscope display. The analog trigger circuitry evaluates the picked off signal. The oscilloscope may include some additional minor trigger path filters such as RF reject for eliminating noise on the trigger path. Filters applied to the trigger path are different from a broader and more capable set of postprocessing filters that can be applied to the signal path. Analog trigger circuitry may be implemented in an ASIC or FPGA, or it may be implemented in off-the-shelf components.

Fig. 1: Analog trigger circuit compared to digital trigger circuit

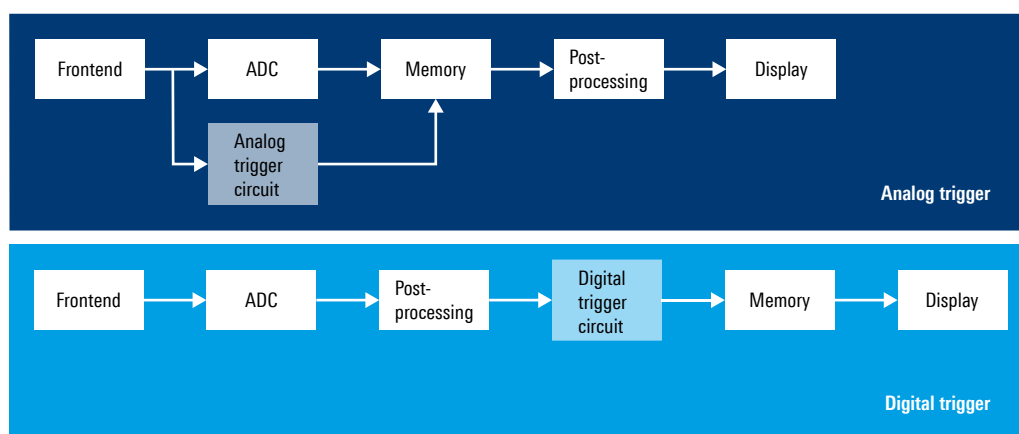

On oscilloscopes with the patented digital triggering architectures, the signal path and the trigger path are the same. Triggering events are evaluated after the instrument's ADC. Users can see the trigger signal on the oscilloscope display because it is the same as the data path signal. Post-acquisition filters such as interpolation, bandwidth filtering and deembedding can all be applied in real time before the oscilloscope evaluates the trigger condition.

Fig. 2: For R&S®MXO 4 and R&S®MXO 5 Series oscilloscopes, the MXO-EP (extreme performance) ASIC includes a dedicated digital trigger block

The 26 nm CMOS ASIC has over 36 million gates and can process 200 Gbit/s.

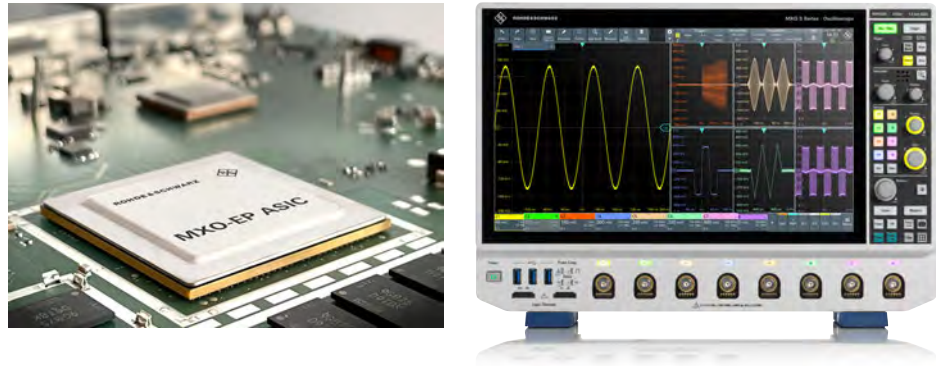

4 DIGITAL TRIGGERING ADVANTAGES

4.1 Greater trigger sensitivity

Oscilloscope trigger sensitivity is specified by the minimum signal amplitude that must be present for the instrument to correctly identify the trigger event. Depending on the oscilloscope manufacturer, the instrument's display has grid markers that divide the display vertically into either eight or ten vertical divisions. The oscilloscope specifications will indicate the number of vertical divisions a signal's amplitude must be for the trigger circuitry to ensure proper trigger event identification.

For example, for an oscilloscope that specifies a trigger sensitivity of one vertical division, if the oscilloscope is set to 100 mV/div, a trigger signal such as an edge must have an amplitude of at least 100 mV to ensure that the oscilloscope will correctly trigger. On oscilloscopes with eight vertical divisions, one division represents 12.5% of full screen vertical scale, so one division would correspond to an amplitude of 125 mV. On some oscilloscopes, trigger sensitivity is not a single specification, but instead varies by vertical scaling (V/div), bandwidth and trigger types.

Fig. 3: Trigger sensitivity definition

The trigger sensitivity is defined in terms of the required amplitude of a signal, measured in vertical divisions, for the oscilloscope to ensure the signal will be detected as a trigger event.

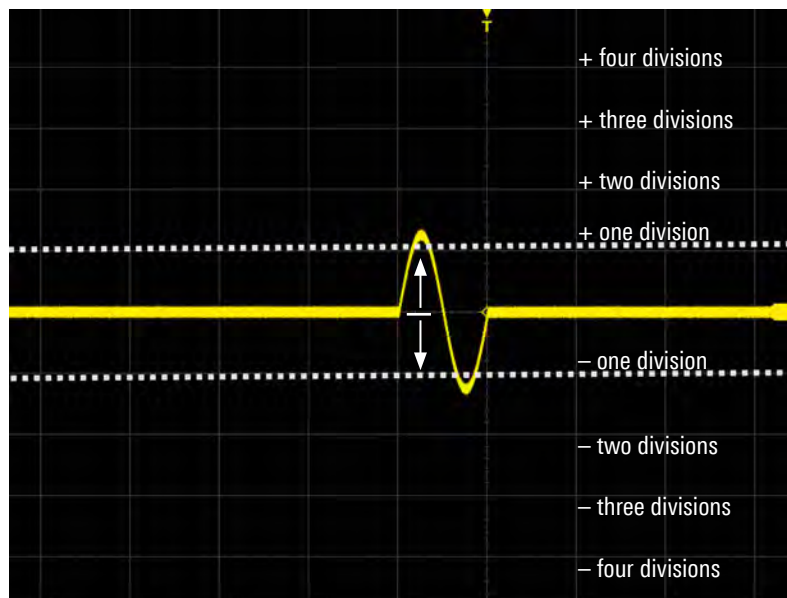

Digital triggers can trigger on signals with significantly lower amplitude than analog triggers. Why is this important? Superior trigger sensitivity gives users the ability to use the trigger to isolate small signals in the presence of larger signals.

Let's look at an example. The R&S®MXO 4 and R&S®MXO 5 Series oscilloscopes have a trigger sensitivity of 0.0001 div. If the instrument is set to 10 mV/div, full vertical height is 100 mV. Remarkably, the oscilloscope can trigger on 1/10000 of 100 mV or on a signal with 10 μ V amplitude. For signals with low amplitude, measurement noise can mask the waveform shape. HD mode on Rohde&Schwarz oscilloscopes offers a method of trading off bandwidth for lower noise, and the HD signal is presented to the trigger to enable triggering on these small amplitude changes.

Fig. 4: World's most sensitive trigger

Digital trigger sensitivity of just 0.0001 div is available on oscilloscopes like the R&S®MXO 4 and R&S®MXO 5 Series. This enables isolation of events with very low amplitude relative to larger signal amplitudes simultaneously on the instrument's display.

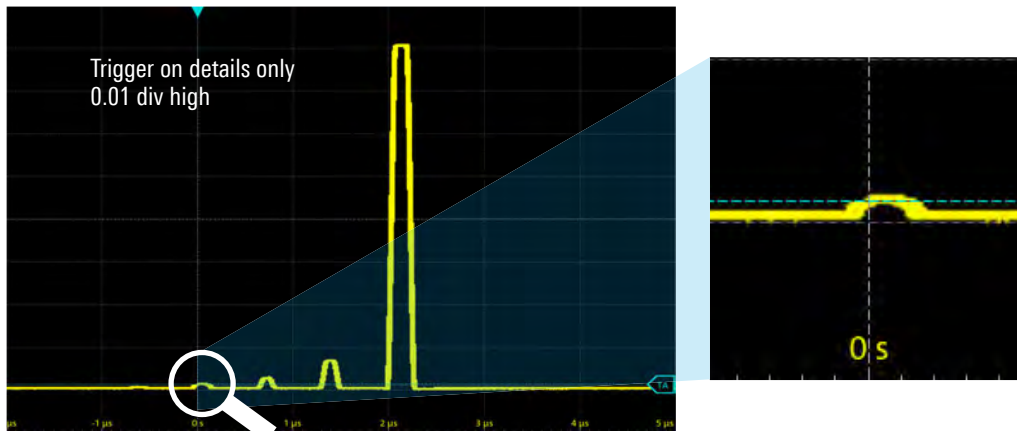

4.2 User hysteresis control

Users specify a trigger threshold and have control over this value by turning a knob or entering a trigger level in a dialog. When a signal passes through the threshold, it must exceed the threshold level by a certain amplitude in order for the oscilloscope to recognize the change as a trigger event. Trigger hysteresis is the amount of additional amplitude beyond a specified trigger level.

Fig. 5: Trigger hysteresis for greater trigger flexibility

All oscilloscope trigger sources have a threshold setting that determines low from high. For trigger types like edge, the hysteresis determines the minimum amplitude a signal must transition to be recognized as a trigger event. Hysteresis is useful for ensuring the oscilloscope does not trigger on measurement noise or signal noise.



For instruments with analog oscilloscope triggers, hysteresis is set internally by the manufacturer and is typically not adjustable by users. Or, there might be a few preset values (i.e. RF reject). For oscilloscopes with newer digital triggers, the hysteresis amplitude can be automatically set with settings identical to their analog counterparts. Moreover,

digital trigger hysteresis values can be adjusted to specific relative and/or absolute values determined by the user. User-adjustable hysteresis enables teams to set a high value to eliminate false triggers due to noise, or to set low values to trigger on small subtle changes in the signal amplitude.

Fig. 6: Digital triggers for user control of trigger hysteresis

This flexibility allows users to trigger on different parts of a waveform that analog triggers cannot easily isolate.

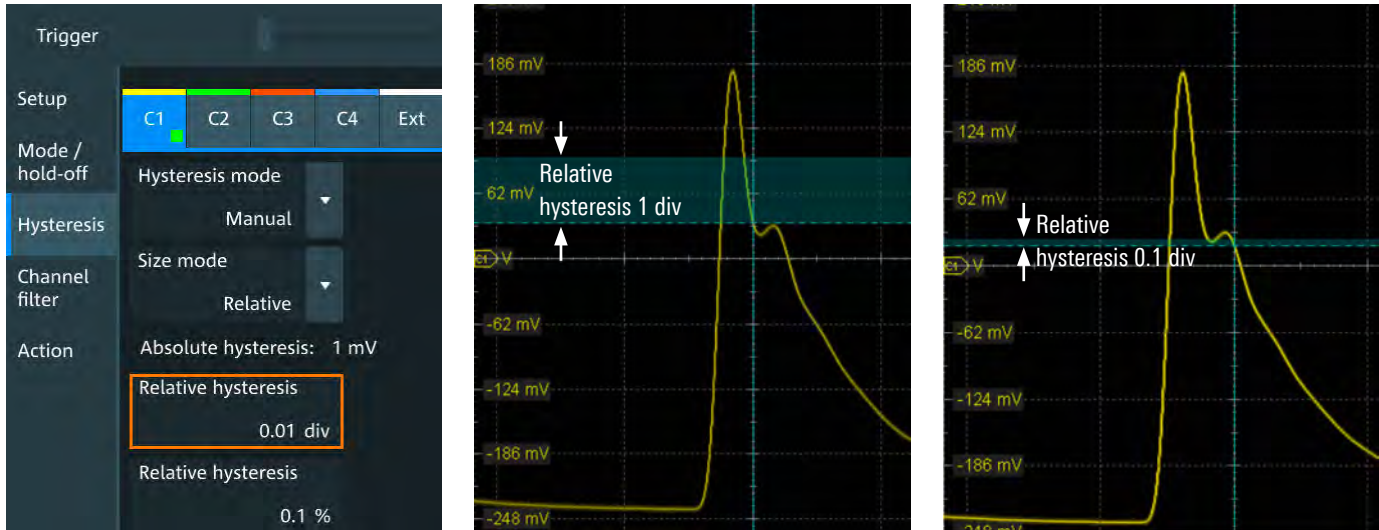

4.3 Wider range of filters

All oscilloscopes available on the market generally have a variety of filters for signal viewing. Examples include bandwidth limit filters. Bandwidth limit filters may be implemented in analog hardware, using DSP algorithms (typically in FPGAs), or in software. For oscilloscopes with analog trigger architectures, signal path filters are not seen by the trigger circuit. For oscilloscopes with digital trigger architectures, filters can be applied to either the digital trigger, to the signal for viewing and analysis, or to both. An advantage is that what you see on the oscilloscope mirrors exactly what your oscilloscope trigger is evaluating.

Fig. 7: Oscilloscopes with analog triggers only apply deembedding to the displayed signal, not to the trigger.

In the R&S®RTP oscilloscope, real-time deembedding is applied before the trigger, enabling the oscilloscope to trigger on the same deembedded signal that users see on the oscilloscope display.

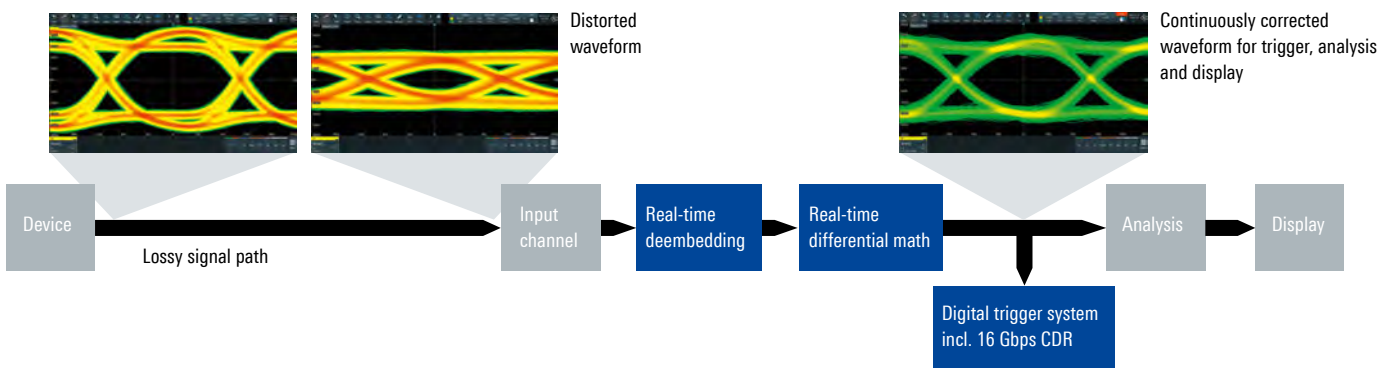

4.4 HD mode applied on trigger

For signals with low amplitudes, oscilloscope noise can mask the signal for viewing as well as for triggering. An oscilloscope can never trigger on a small signal whose amplitude is buried by the instrument's inherent system measurement noise. Most oscilloscopes have an acquisition mode that allows for tradeoffs between bandwidth and vertical resolution. Common names for this mode include high-res, eRes or HD mode. For

high-res, a moving boxcar filter averages adjacent samples, reducing the effective sample rate, but increasing the vertical resolution. For oscilloscopes with analog triggers, high-res applies exclusively to the signal path and not to the trigger path.

For oscilloscopes with digital triggering like the R&S®MXO 4 and R&S®MXO 5 Series, high definition (HD) mode offers a similar tradeoff between bandwidth and vertical resolution by applying a DSP based filter. HD mode can enable up to 18-bit trigger resolution, and has the added benefit of noise suppression via bandwidth reduction. This technique greatly reduces the system measurement noise and increases the trigger sensitivity to a higher value than described previously. The HD mode in the R&S®MXO 4 and R&S®MXO 5 Series can be applied as low as 1 kHz with increased trigger resolution to 18 bit.

Fig. 8: HD mode in combination with the Rohde & Schwarz digital trigger

Unlike oscilloscopes with analog triggers, the Rohde & Schwarz digital triggering architecture allows HD mode to be applied in real time to the signal being viewed as well as to the trigger.

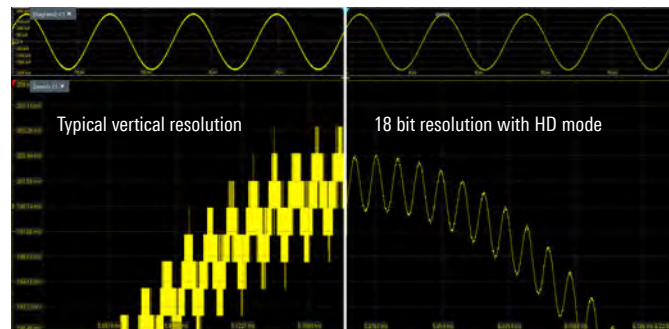

4.5 Interpolation

Architectures with analog trigger circuits split part of the user signal to create a trigger path. The trigger path is analog. Therefore, these analog circuits typically have a threshold range that has more coarse increments. For example, threshold settings may be limited to increments of 100 mV.

For digital triggers, users can choose any threshold value as long as that value is within the set vertical range and thus on the oscilloscope display. This is because the digital trigger architecture evaluates the signal after the ADC. Since the information is digital, the instrument can even make trigger decisions based on interpolation between sampled points.

Fig. 9: Digital triggers use interpolation for more precise trigger level values

Digital triggers can use interpolation between sample points to eliminate areas that would otherwise be blind for triggering. This results in better trigger sensitivity down to 0.0001 div.

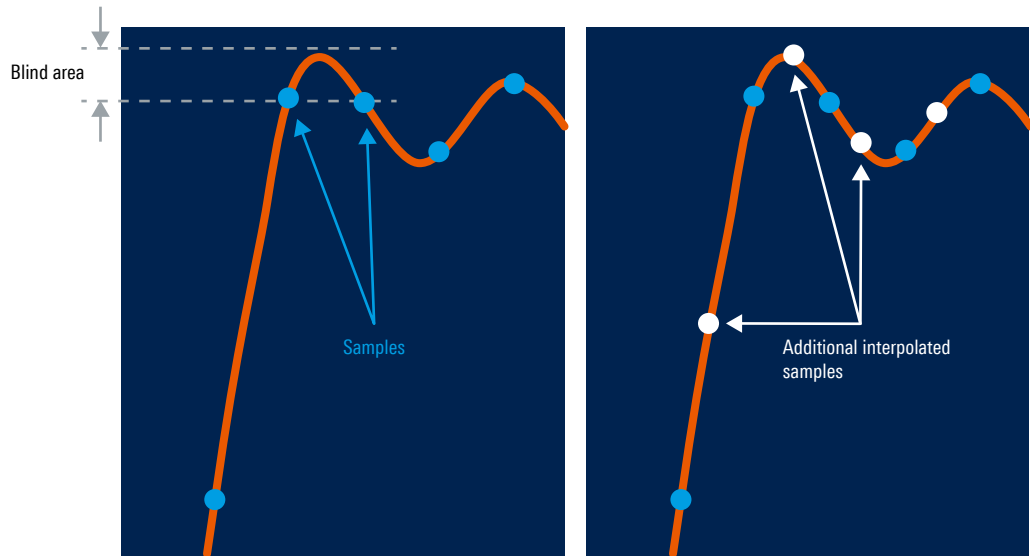

4.6 Lower trigger jitter

Oscilloscopes with analog triggers are subject to more trigger jitter than oscilloscopes with digital triggers. For analog triggers, the trigger path and the signal path are different. When a trigger event is detected in the trigger path, the oscilloscope must determine the exact time in the signal path that correlates. Over successive acquisitions, users will notice some amount of trigger jitter. Some oscilloscope manufacturers provide software based correction for trigger jitter. This technique works well to minimize trigger jitter, but requires defined processing cycles, thus slowing down the trigger rearm time and overall oscilloscope update rate.

Fig. 10: Oscilloscopes with digital triggers have minimal trigger jitter

In the case of the R&S®MXO 4 and R&S®MXO 5 Series, the trigger jitter is the lowest in class with a value < 1 ps.



5 DIGITAL OR ANALOG TRIGGER: HOW TO TELL?

Most oscilloscope triggers are analog. If not mentioned in the specifications, an oscilloscope likely incorporates older analog trigger technology. Ask your oscilloscope manufacturer if a specific oscilloscope has digital or analog triggering. Alternatively, a few items in the oscilloscope's specifications should allow you to make an educated guess:

- ▶ Trigger sensitivity: If the trigger sensitivity is less than 0.1 div, the oscilloscope's trigger architecture is digital. Analog triggers cannot achieve this sensitivity.
- ▶ User hysteresis control: If the instrument allows the user to set a wide range of trigger hysteresis values from very large to very small (e.g. 5 div down to 0.01 div), the instrument has a digital trigger. Analog triggers allow the user to choose from a few preset conditions, but do not have full hysteresis control that users can set.
- ▶ Trigger rearm time: If the minimum trigger rearm time in normal mode (not a special mode) is on the order of tens to hundreds of nanoseconds, the oscilloscope likely has a digital trigger architecture.

6 CONCLUSION

Digital trigger circuits incorporate a number of advantages that older analog trigger technologies do not include. Understanding these attributes makes it easier to determine how important these advantages are for a team when choosing an oscilloscope.

Rohde&Schwarz has invested into ASIC technology that incorporates digital triggering. Rohde&Schwarz oscilloscopes that feature digital triggering include:

- ▶ R&S®MXO 4 Series oscilloscopes: These are the first instruments in the next generation of R&S®MXO oscilloscopes. Each instrument comes equipped with MXO-EP (extreme performance) ASIC technology that includes digital triggering and has the most sensitive triggering in its class.
- ▶ R&S®MXO 5 Series oscilloscopes: These instruments have the most sensitive triggering for eight-channel oscilloscopes. Each instrument comes equipped with MXO-EP (extreme performance) ASIC technology that includes digital triggering.
- ▶ R&S®RTO6 oscilloscopes: These instruments incorporate an ASIC developed by Rohde&Schwarz with digital triggering. Industry best trigger sensitivity of 0.0001 div is standard on each model.
- ▶ R&S®RTP oscilloscopes: These instruments include the same digital trigger ASIC as the R&S®RTO6 and share the distinction of having the industry's most sensitive trigger. The digital trigger of the R&S®RTP runs at full bandwidth (up to 16 GHz) and includes numerous other triggering capabilities, such as triggering on deembedded signals.

Fig. 11: Rohde & Schwarz pioneered digital triggering for oscilloscopes

All R&S®MXO Series, R&S®RTO6 and R&S®RTP oscilloscopes include digital triggering.



Parameter	R&S®MXO 4 Series	R&S®MXO 5 Series	R&S®RTO6 Series	R&S®RTP Series
Digital trigger included			•	
User-selectable trigger hysteresis possible			•	
Minimum trigger sensitivity			0.0001 div	
Minimum trigger rearm time (run mode at 20 ns/div)		21 ns	2.5 μ s	3.5 μ s
Trigger jitter		< 1 ps		< 80 fs



dataTec

Mess- und Prüftechnik. Die Experten.

**Ihr Ansprechpartner /
Your Partner:**

dataTec AG

E-Mail: info@datatec.eu

>>> www.datatec.eu

Rohde & Schwarz

The Rohde & Schwarz technology group is among the trailblazers when it comes to paving the way for a safer and connected world with its leading solutions in test & measurement, technology systems and networks & cybersecurity. Founded more than 85 years ago, the group is a reliable partner for industry and government customers around the globe. The independent company is headquartered in Munich, Germany and has an extensive sales and service network with locations in more than 70 countries.

www.rohde-schwarz.com

Rohde & Schwarz customer support

www.rohde-schwarz.com/support

