

DATA SHEET

# EXG X-Series Signal Generator

## N5173B Microwave Analog

9 kHz to 13, 20, 31.8, or 40 GHz



Mess- und Prüftechnik. Die Experten.

Ihr Ansprechpartner /  
Your Partner:

dataTec AG  
E-Mail: [info@datatec.eu](mailto:info@datatec.eu)  
>>> [www.datatec.eu](http://www.datatec.eu)

 **KEYSIGHT**  
Authorized Premium  
Distributor

## Table of Contents

Definitions .....	3
Specification (spec): .....	3
Typical (typ): .....	3
Nominal (nom) or measured (meas): .....	3
Frequency Specifications .....	4
Amplitude Specifications .....	6
Spectral Purity Specifications .....	9
Analog Modulation Specifications .....	13
General Characteristics .....	18
Inputs and Outputs .....	20
Related Literature .....	21
Confidently Covered by Keysight Services .....	22

## Definitions

### Specification (spec):

Specifications represent warranted performance of a calibrated instrument that has been stored for a minimum of 2 hours within the operating temperature range of 0 to 55 °C, unless otherwise stated, and after a 45 minute warm-up period. The specifications include measurement uncertainty. Data represented in this document are specifications unless otherwise noted.

### Typical (typ):

Typical (typ) describes additional product performance information. It is performance beyond specifications that 80 percent of the units exhibit with a 95 percent confidence level at room temperature (approximately 25 °C). Typical performance does not include measurement uncertainty.

### Nominal (nom) or measured (meas):

Nominal (nom) or measured (meas) describes a performance attribute that is by design or measured during the design phase for the purpose of communicating sampled, mean or average performance, such as the 50 ohm connector or amplitude drift vs. time. This data is not warranted and is measured at room temperature (approximately 25 °C).

## Frequency Specifications

Range			
Frequency range	Option 513	9 kHz to 13 GHz	
	Option 520	9 kHz to 20 GHz	
	Option 532	9 kHz to 31.8 GHz	
	Option 540	9 kHz to 40 GHz	
Resolution	0.001 Hz		
Phase offset	Adjustable in nominal 0.1° increments		
Frequency switching speed <sup>1</sup> () = typical			
	Standard	Option UNZ <sup>2, 4</sup>	Option UZ2, <sup>3, 4</sup>
CW mode			
SCPI mode	(≤ 5 ms)	≤ 1.15 ms (≤ 750 μs)	< 1.65 ms (1 ms)
List/step sweep mode	(≤ 5 ms)	≤ 900 μs (≤ 600 μs)	< 1.4 ms (850 μs)

1. Time from receipt of SCPI command or trigger signal to within 0.1 ppm of final frequency or within 100 Hz, whichever is greater.
2. For export control purposes CW switching speed to within 0.05% of final frequency is 190 μs (meas).
3. For export control purposes CW switching speed to within 0.05% of final frequency is > 400 μs (nom) below 20 GHz and > 600 μs (nom) above 20 GHz.
4. Specifications apply when status register updates are off.

Frequency reference	
Accuracy	± aging rate ± temperature effects ± line voltage effects ± initial setting accuracy
Internal time base reference oscillator aging rate <sup>1</sup>	< ± 1 x 10 <sup>-7</sup> /year <sup>2</sup> < ± 5 x 10 <sup>-10</sup> /day after 30 days
Initial achievable calibration accuracy	± 4 x 10 <sup>-8</sup> or ± 40 ppb
Adjustment resolution	< 1 x 10 <sup>-10</sup> (nom)
Temperature effects	< ± 2 x 10 <sup>-8</sup> from 20 to 30 °C (nom)
Line voltage effects	< ± 1 x 10 <sup>-9</sup> for ± 10% change (nom)
Reference output	
Frequency	10 MHz
Amplitude	≥ +4 dBm, (nom) into 50 Ω load
External reference input	
Input frequency standard	10 MHz
Input frequency Option 1ER	1 to 50 MHz (in multiples of 0.1 Hz)
Lock range	± 1 ppm (nom)
Amplitude	5 dBm ± 2 dB (nom) <sup>3</sup>
Impedance	50 Ω (nom)
Waveform	Sine or square
Stability	Follows the stability of external reference input signal
Sweep modes (frequency and amplitude)	
Operating modes	Step sweep (equally spaced frequency and amplitude or logarithmically spaced frequency steps) List sweep (arbitrary list of frequency and amplitude steps) Simultaneously sweep waveforms with N5182B; see baseband generator section for more detail
Sweep range	Within instrument frequency range
Dwell time	100 μs to 100s
Number of points	2 to 65535 (step sweep) 1 to 3201 (list sweep)
Step change	Linear or logarithmic
Triggering	Free run, trigger key, external, timer, bus (GPIB, LAN, USB)

1. Not verified by Keysight N7800A TME Calibration and Adjustment Software. Daily aging rate may be verified as a supplementary chargeable service, on request.
2. After one year of operation, aging rate drops to < ± 3 x 10<sup>-8</sup> per year or ± 30 ppb/year.
3. Inputs between +3 dBm to +20 dBm are allowed.

## Amplitude Specifications

Output parameters	
Settable range (with Option 1E1 and 1EA)	+30 to -135 dBm
Settable range (without Option 1E1 and 1EA)	+19 to -20 dBm
Resolution	0.01 dB
Step attenuator (1E1)	0 to 115 dB in 10 dB steps mechanical type
Attenuator hold range	-15 dBm to maximum specified output power with step attenuator in 0 dB state; can be offset using option 1E1 mechanical attenuator
Connector	513/520 = 3.5 SMA male, 532/540 = 2.4 mm male, 50 $\Omega$ (nom) (Option 1ED adds Type-N connector to a 513 or 520)

### Max output power <sup>1</sup> (dBm, with or without step attenuator, Option 1E1)

Frequency	Standard	High power Option 1EA
Option 513, 520		
9 kHz to 3.2 GHz	+18	+23
> 3.2 to 13 GHz	+18	+20
> 13 to 20 GHz	+15	+19
Option 532, 540		
9 kHz to 3.2 GHz	+14	+21
> 3.2 to 17 GHz	+14	+16
> 17 to 31.8 GHz	+13	+15
> 31.8 to 40 GHz	+11	+15

1. Quoted specifications between 15 and 35 °C. Maximum output power typically decreases by 0.05 dB/°C for temperatures outside this range.

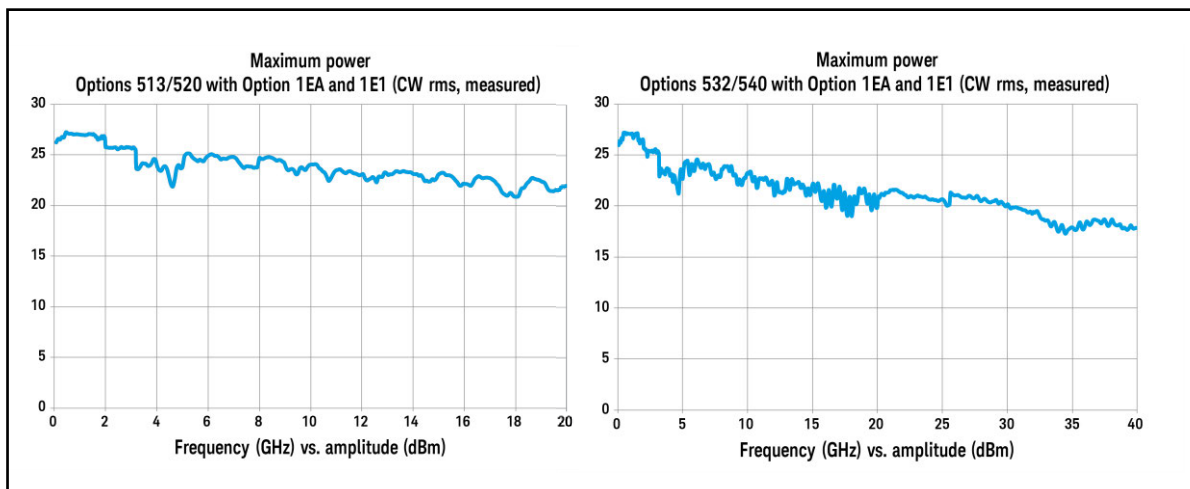

Absolute level accuracy in CW mode <sup>1,2</sup> (ALC on) () = typical

	With or without Option 1E1			With Option 1E1		
	Max power to +10 dBm	< +10 to -10 dBm	< -10 to -20dBm	< -20 to -75 dBm	< -75 to -90 dBm	< -90 to -120 dBm
9 kHz to 2 GHz	± 0.6 dB	± 0.6 dB	± 0.7 dB	± 0.7 dB	± 1.4 dB	(± 0.3)
> 2 to 20 GHz	± 0.9 dB	± 0.7 dB	± 0.7 dB	± 0.7 dB	± 1.6 dB	(± 0.3)
> 20 to 40 GHz	± 0.9 dB	± 0.8 dB	± 1.1 dB	± 1.1 dB	± 2.0 dB	

1. Level accuracy applies between 15 °C and 35 °C. Specifications do not apply above the maximum specified power. For temperatures outside this range, absolute level accuracy degrades by 0.01 dB/degree C for frequencies ≤ 4.5 GHz and 0.02 dB/degree C for frequencies > 4.5 GHz.
2. For instruments with Type-N connectors (Option 1ED), specifications are degraded typically 0.2 dB above 18 GHz.

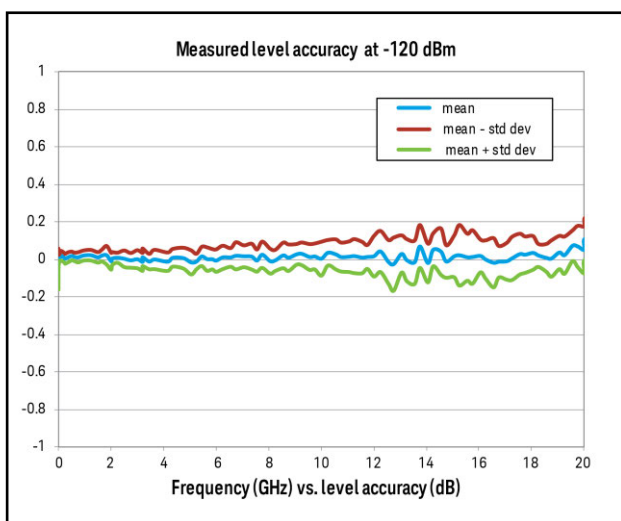
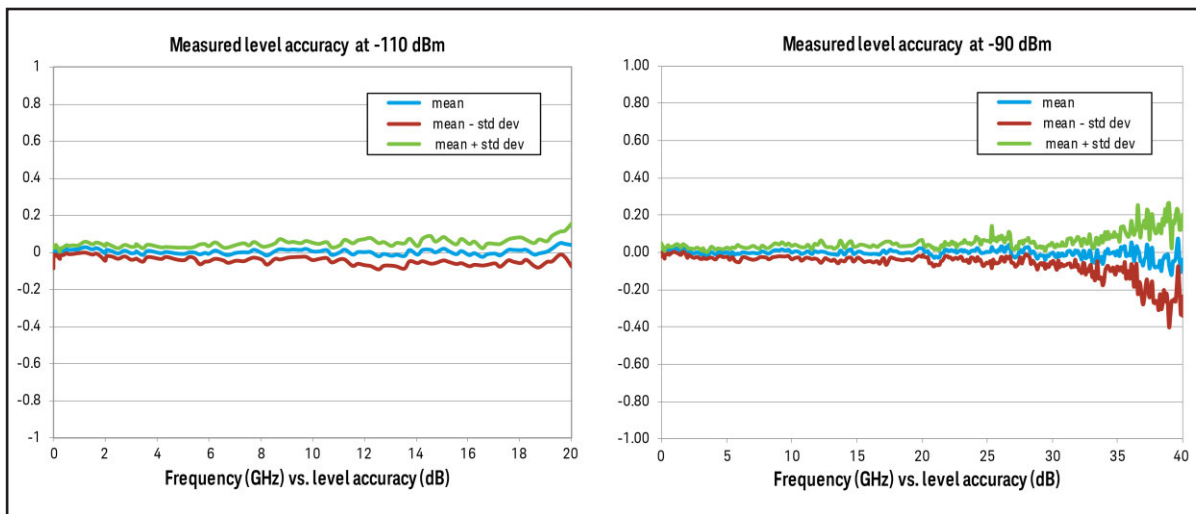

SWR (measured CW mode)		
Frequency	Attenuator state	
	0 dB	5 dB and greater
≤ 2 GHz	< 1.7:1	< 1.2:1
> 2 to 8 GHz	< 1.4:1	< 1.4:1
> 8 to 13 GHz	< 1.6:1	< 1.5:1
> 13 to 20 GHz	< 1.8:1	< 1.7:1
> 20 to 40 GHz	< 1.6:1	< 1.4:1
External detector leveling <sup>1</sup>		
Range	-0.2 mV to -0.5 V (nom)	
Bandwidth	10 kHz (typ)	
Amplitude switching speed <sup>2</sup>		
SCPI mode	≤ 2 ms (typ)	
Power search SCPI mode <sup>3</sup>	< 12 ms (meas)	
List/step sweep mode	≤ 2 ms (typ)	
User flatness correction		
Number of points	3201	
Number of tables	Dependent on available free memory in instrument; 10,000 maximum	
Entry modes	USB/LAN direct power meter control, LAN to GPIB and USB to GPIB, remote bus, and manual USB/GPIB power meter control	
Sweep modes		
	See Frequency Specifications section for more detail	

1. Not intended for pulsed operation.
2. Time from receipt of SCPI command or trigger signal to amplitude settled within 0.2 dB. Specification does not apply when switching to or from frequencies < 5 MHz, or when ALC level is < 0 dBm, or when frequency crosses 0.002, 0.02, 0.1, 2.0, 3.2, 5.0, 6.4, 8, 10, 12.8, 16, 20, 25.6, or 32 GHz.
3. When ALC is off and power search mode is disabled amplitude switching is < 250 μs (meas).



# Spectral Purity Specifications

Standard absolute SSB phase noise (dBc/Hz) (CW) [at 20 kHz offset] <sup>1</sup> () = measured	
5 to < 250 MHz	-115 (-120)
250 MHz	-129 (-134)
500 MHz	-124 (-128)
1 GHz	-118 (-122)
2 GHz	-111 (-116)
3 GHz	-105 (-110)
4 GHz	-104 (-110)
6 GHz	-99 (-104)
10 GHz	-97 (-101)
20 GHz	-90 (-95)
40 GHz	-84 (-91)
Standard absolute SSB phase noise (dBc/Hz) (CW) [at 100 Hz offset] () = measured	
100 MHz	(-104)
250 MHz	(-115)
500 MHz	(-110)
1 GHz	(-104)
2 GHz	(-97)
3 GHz	(-93)
4 GHz	(-91)
6 GHz	(-89)
10 GHz	(-83)
20 GHz	(-76)
40 GHz	(-70)

1. From 0 to 55 °C, measured at +10 dBm.

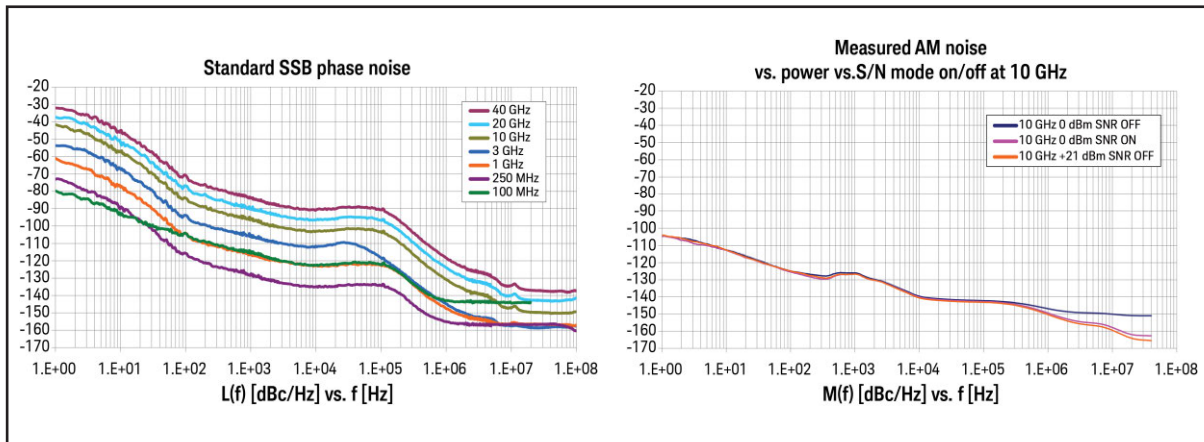

Broadband noise <sup>1</sup> () = measured		
100 MHz	(-143 dBc/Hz)	
500 MHz	(-155 dBc/Hz)	
1 GHz	(-163 dBc/Hz)	
10 GHz	(-150 dBc/Hz)	
20 GHz	(-143 dBc/Hz)	
40 GHz	(-135 dBc/Hz)	
Residual FM (CW mode, rms) See frequency band table for N value		
0.3 to 3 kHz bandwidth	< N* 0.5 Hz (meas)	
0.05 to 15 kHz bandwidth	< N* 3 Hz (meas)	
Residual AM (CW mode, +10 dBm, 0.3 kHz to 3 kHz bandwidth, rms)		
< 2 GHz	< 0.01% (meas)	
Harmonics [CW mode] <sup>2</sup> () = typical		
Range	CW mode at +10 dBm	CW mode at +20 dBm <sup>3</sup>
9 kHz to 200 MHz	< -48 dBc (-54)	< -38 dBc (-43)
> 200 MHz to 2 GHz	< -33 dBc (-40)	< -25 dBc (-31)
> 2 to 20 GHz	< -55 dBc (-65)	< -50 dBc (-55)

1. CW mode at +10 dBm for offsets > 10 MHz. In high signal to noise ratio mode (optimize S/N).
2. Specifications apply from +15 to +35 °C and are nominal for harmonics beyond specified frequency range.
3. Or maximum specified output power, whichever is lower.

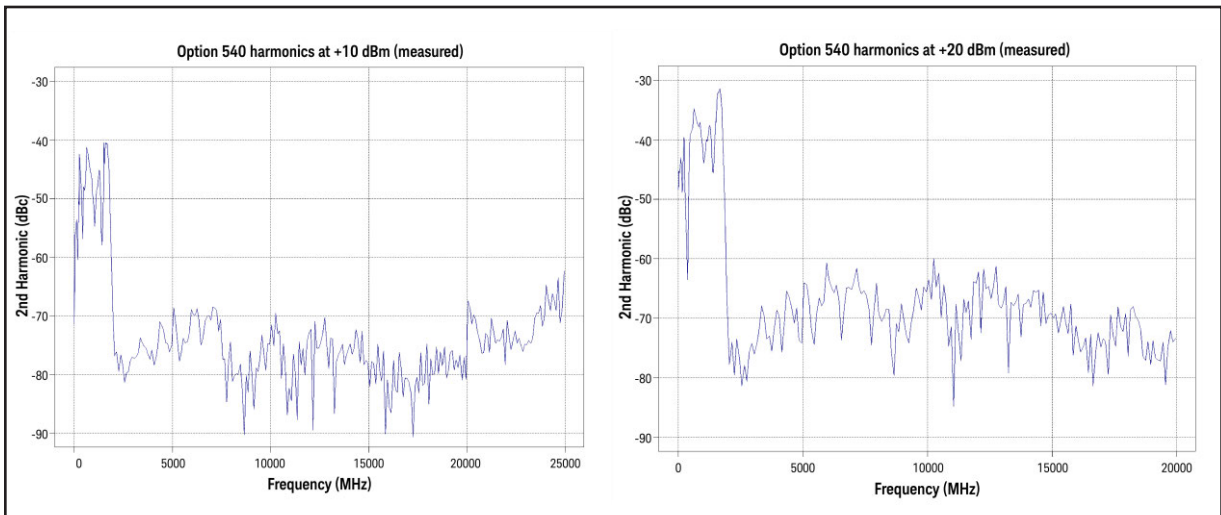
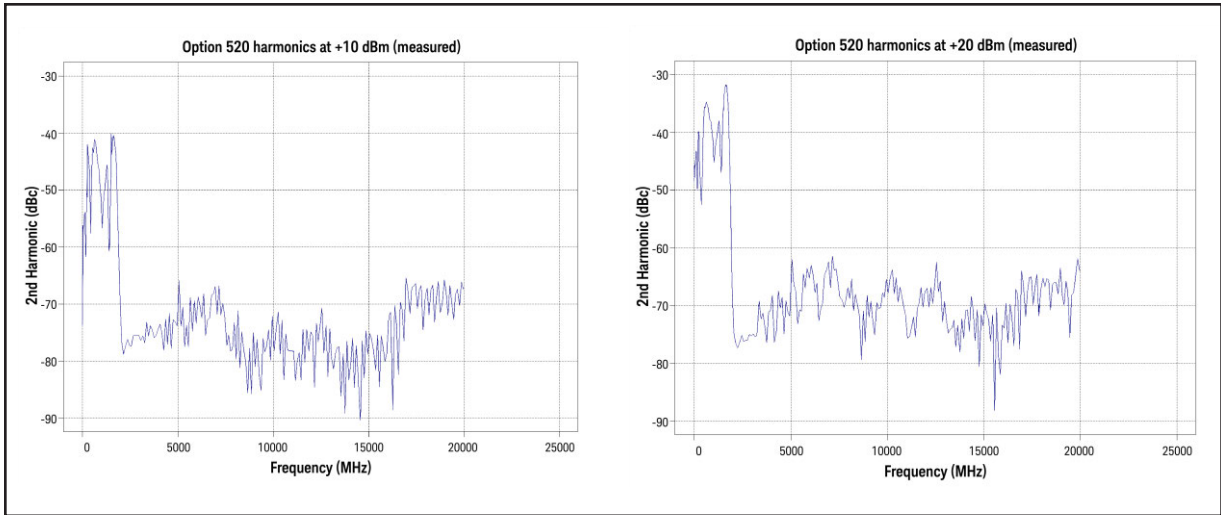

Nonharmonics (CW mode) <sup>1,2</sup>	
Range	> 10 kHz offset
Standard (dBc)	
9 kHz to < 5 MHz	-65
5 to < 250 MHz	-75
250 to < 750 MHz	-78
750 MHz to < 1.5 GHz	-72
1.5 to < 3 GHz	-66
3 to < 20 GHz	-60
20 to 40 GHz	-54
Subharmonics (CW mode)	
9 kHz to 1.5 GHz	None
> 1.5 to 3.2 GHz	-75
> 3.2 to 5 GHz	-67
> 5 to 10 GHz	-67
> 10 to 20 GHz	-56
> 20 to 40 GHz	-53

1. CW mode at +10 dBm.
2. Power line related non-harmonics: 60 Hz to 300 Hz: < -50 dBc. Measured from 1 MHz to 40 GHz.

Jitter <sup>1</sup> (measured)				
Carrier frequency	SONET/SDH data rate	rms jitter BW	$\mu\text{UI rms}$	Picoseconds
155 MHz	155 MB/s	100 Hz to 1.5 MHz	126	0.8
622 MHz	622 MB/s	1 kHz to 5 MHz	62	0.1
2.488 GHz	2488 MB/s	5 kHz to 20 MHz	251	0.1
9.953 GHz		10 kHz to 80 MHz	939	0.094
39.812 GHz		40 kHz to 320 MHz	3408	0.086

1. Calculated from phase noise performance in CW mode at +10 dBm. For other frequencies, data rates, or bandwidths, please consult your sales representative.

## Analog Modulation Specifications

Frequency bands		
Band #	Frequency range	N
1	9 kHz to < 5 MHz	Digital synthesis
2	5 to < 250 MHz	1
3	250 to < 375 MHz	0.25
4	375 to < 750 MHz	0.5
5	750 MHz to < 1.5 GHz	1
6	1.5 to < 3 GHz	2
7	3 to < 6 GHz	4
8	6 to < 12 GHz	8
9	12 to < 24 GHz	16
10	24 to 40 GHz	32
Frequency modulation (Option UNT) (See N value above)		
Max deviation	$N \times 10 \text{ MHz (nom)}$ <sup>1</sup>	
Resolution	0.025% of deviation or 1 Hz, whichever is greater (nom)	
Deviation accuracy	$< \pm 2\% + 20 \text{ Hz}^2$ [1 kHz rate, deviation is $N \times 50 \text{ kHz}$ ]	
Modulation frequency response @ 100 KHz deviation	1 dB bandwidth	DC/5 Hz to 3 MHz (nom)
	3 dB bandwidth	DC/1 Hz to 7 MHz (nom)
Carrier frequency accuracy Relative to CW after DC cal	$< \pm 0.2\%$ of set deviation + $(N \times 1 \text{ Hz})$ <sup>3</sup>	
	$< \pm 0.06\%$ of set deviation + $(N \times 1 \text{ Hz})$ (typ) <sup>4</sup>	
Distortion	$< 0.4\%$ [1 kHz rate, deviation is $N \times 50 \text{ kHz}$ ]	
FM using external inputs 1 or 2	Sensitivity	+1 V peak for indicated deviation (nom)
	Input impedance	<b>50 <math>\Omega</math>/600 <math>\Omega</math>/1 M<math>\Omega</math> (nom)</b>
	Paths	FM path 1 and FM path 2 are summed internally for composite modulation
Phase modulation (Option UNT) (See N value above)		
Maximum deviation	Normal bandwidth	$N \times 5$ radians (nom)
	High-bandwidth mode	$N \times 0.5$ radians (nom)
Frequency response	Normal bandwidth (3 dB)	DC to 1 MHz (nom)
	High-bandwidth mode (3 dB)	DC to 4 MHz (nom)
Resolution	0.1% of deviation	
Deviation accuracy	$< +0.5\% + 0.01 \text{ rad (typ)}$ [1 kHz rate, normal BW mode]	
Distortion	$< 0.2\%$ (typ) [1 kHz rate, $N \times 1$ radian deviation normal BW mode]	

### Phase modulation (Option UNT) (See N value above)

ΦM using external inputs 1 or 2	Sensitivity	+1 V peak for indicated deviation (nom)
	Input impedance	50 Ω or 600 Ω or 1 MΩ (nom)
	Paths	ΦM path 1 and ΦM path 2 are summed internally for composite modulation

1. Digital synthesis band FM deviation is 5 MHz.
2. Specification applies from 15 to 35 °C.
3. Specification valid for temperature changes of less than ± 5 °C since last DC calibration.
4. Typical performance immediately after a DC calibration.

### Amplitude modulation (Option UNT) <sup>1</sup>

Depth		Linear mode	Exponential mode
Settable depth ALC ON with deep AM (default) or ALC off <sup>2</sup>		0 to 100%	0 to 50 dB
Depth resolution		0.1% (nom)	0.01 dB (nom)
AM depth accuracy ALC on <sup>3</sup> [@ 1kHz rate, < 80% depth]	f < 5 MHz	< 1.5% of setting +1% (typ 0.5% of setting +1%)	± 2 dB @ 40 dB depth (typ) <sup>4</sup>
	5 MHz ≤ f ≤ 3.2 GHz	< 4% of setting + 1%	± 2 dB @ 40 dB depth (typ) <sup>4</sup>
	> 3.2 to 40 GHz	(typ 3% of setting +1%)	± 4 dB @ 40 dB depth (typ) <sup>4</sup>

### Total harmonic distortion (@ 1 KHz rate)

f < 5 MHz	30% depth	< 0.25% (typ)
	80% depth	< 0.5% (typ)
5 MHz < f ≤ 40 GHz	30% depth	< 2%
	80% depth	< 3%

### Frequency response (30% depth, 3 dB BW)

9 kHz to ≤ 3.2 GHz	DC/10 Hz to 50 kHz <sup>5</sup>
> 3.2 to 40 GHz	DC/10 Hz to 100 kHz <sup>5</sup>

### AM inputs using External Inputs 1 and 2

Sensitivity	± 1 V peak for indicated depth (over-range can be 200% or 2.2 V peak)
Input impedance	50 Ω or 600 Ω or 1 MΩ, damage level: ± 5 V max
Paths	AM Paths 1 and 2 are summed internally for composite modulation

Simultaneous and composite modulation				
Simultaneous modulation	All modulation types (FM, AM, $\Phi$ M and pulse modulation) may be simultaneously enabled except: FM and phase modulation cannot be combined: two modulation types cannot be simultaneously generated using the same modulation source. For example the Pulse, AM, and FM can run concurrently and all will modulate the output RF. This is useful for simulating signal impairments, FM chirp RADAR, or scan modulation.			
Composite modulation	AM, FM, and $\Phi$ M each consist of two modulation paths which are summed internally for composite modulation. Modulation can be any combination of internal or external sources.			
	AM	FM	Phase	Pulse
AM	+	+	+	+
FM	+	+	-	+
Phase	+	-	+	+
Pulse	+	+	+	-
+ = compatible, - = incompatible				

1. AM specifications apply 6 dB below maximum specified power and down to -15 dBm for Option 520 or -20 dBm for Option 540 from 15 to 35 °C with ALC on.
2. ALC off is used for narrow pulse modulation and/or high AM depths with envelope peaks below ALC operating range. Carrier power level will be accurate after a power search is executed.
3. Deep AM with ALC on provides increased AM depths and improved distortion, together with closed-loop internal leveling. This mode requires a repetitive AM waveform (frequency > 10 Hz) with peaks > -5 dBm (nom), excluding step-attenuator setting.
4.  $\pm 2$  dB @ 40 dB, and 50 dB < 31.8 GHz, and  $\pm 4$  dB @ 50 dB > 31.8 GHz (meas).
5. From 5 MHz to 50 MHz carrier roll off is < 5 dB at 50 kHz rate. From 50 MHz to 3.2 GHz rate is useable up to 100 kHz. Above 3.2 GHz rate is useable to 1 MHz.

External modulation inputs	
(Option UNT required for FM, AM, and phase modulation inputs; Option UNW required for pulse modulation inputs)	
EXT1	AM, FM, PM
EXT2	AM, FM, PM
PULSE	Pulse (50 $\Omega$ only)
Input impedance	50 $\Omega$ , 1 M $\Omega$ , 600 $\Omega$ , DC and AC coupled
Standard internal analog modulation source	
(Waveform generator for use with AM, FM, phase modulation, and LF out; requires Option UNT)	
Waveform	Sine, square, triangle, positive ramp, negative ramp
Rate range	0.1 Hz to 2 MHz (tunable to 3 MHz)
Resolution	0.1 Hz
Frequency accuracy	Same as RF reference source (nom)
LF audio output	0 to 5 V peak into 50 $\Omega$ , -5 V to 5 V offset (nom)

### Multifunction generator (Option 303)

The multifunction generator option (Option 303) consists of 7 waveform generators that can be set independently with up to 5 simultaneously using the composite modulation features in AM, FM/PM plus LF out

#### Waveform

Function generator 1	Sine, triangle, square, pos ramp, neg ramp, pulse
Function generator 2	Sine, triangle, square, pos ramp, neg ramp, pulse
Dual function generator	Sine, triangle, square, pos ramp, neg ramp, pulse, phase offset and amplitude ratio for Tone2 relative to Tone1
Swept function generator	Sine, triangle, square, pos ramp, neg ramp
	Trigger: free run, trigger key, bus, external, internal, timer trigger
Noise generator 1	Uniform, Gaussian
Noise generator 2	Uniform, Gaussian
DC	Only for LF output

#### Frequency parameters

Sine wave	0.1 Hz to 10 MHz
Triangle, square, ramp, pulse	0.1 Hz to 1 MHz
Noise bandwidth	10 MHz
Resolution	0.1 Hz
Frequency accuracy	Same as RF reference source (nom)

### Narrow pulse modulation (Option UNW or UW2) <sup>1</sup>

On/off ratio	> 80 dB (typ) <sup>2</sup>
Rise/fall times (Tr, Tf)	< 10 ns; 7 ns (typ)
Minimum pulse width ALC on/off <sup>3</sup>	≥ 1 μs (500 ns typ) / ≥ 20 ns
Repetition frequency ALC on/off	10 Hz to 500 kHz / DC to 10 MHz
Level accuracy (relative to CW) ALC on/off <sup>4</sup>	± 0.7 dB (± 0.5 typ) / (< ± 0.75 dB typ)
Width compression (RF width relative to video out)	< 5ns (typ)

1. Pulse specifications apply to frequencies > 100 MHz. and power set to > -3 dBm. Operable down to 9 kHz.

2. Above 35 GHz vernier > 0 dBm.

3. For export control purposes option UW2 limits minimum pulse width above 31.8 GHz to ≥ 500 ns.

4. With power search on.



Video feed-through <sup>1</sup> < 3.2 / > 3.2GHz	< 50 mV (typ) / < 3 mV (typ)
Video delay (external input to video)	40 ns, nominal
RF delay (video to RF output)	45 ns, nominal
Pulse overshoot	< 10% (typ)
Input level	+1 V peak = RF On into 50 Ω (nom)

Td video delay (variable)  
 Tw video pulse width (variable)  
 Tp pulse period (variable)  
 Tm RF delay  
 Trf RF pulse width  
 Tf RF pulse fall time  
 Tr RF pulse rise time  
 Vor pulse overshoot  
 Vf video feedthrough

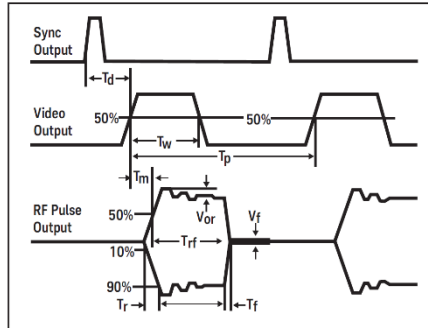

**Internal pulse generator (included with Option UNW or UW2)**

Modes	Free-run, square, triggered, adjustable doublet, trigger doublet, gated, and external pulse	
Square wave rate	0.1 Hz to 10 MHz, 0.1 Hz resolution (nom)	
Pulse period	30 ns to 42 s (nom)	
Pulse width <sup>2</sup>	20 ns to pulse period –10 ns (nom)	
Resolution	10 ns	
Adjustable trigger delay	(-pulse period +10 ns) to (pulse width –10 ns)	
Settable delay	Free run	-3.99 to 3.97 μs
	Triggered	0 to 40 s
Resolution (delay, width, period)	10 ns, nominal	
Pulse doublets	1st pulse delay	(Relative to sync out) 0 to 42 s – pulse width – 10 ns
	1st pulse width	20 ns to 42 s – delay – 10 ns
	2nd pulse delay	0 to 42 s – (delay1 + width2) – 10 ns
	2nd pulse width	20 ns to 42 s – (delay1 + delay2) – 10 ns

**Pulse train generator Option 320 (requires Option UNW or UW2)**

Number of pulse patterns	2047
On/off time range <sup>2</sup>	20 ns to 42 s

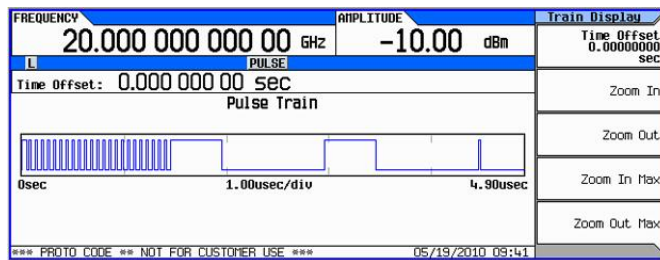

1. Video feed through applies to power levels < +10 dBm.
2. For export control purposes option UW2 limits minimum pulse width above 31.8 GHz to ≥ 500 ns.

## General Characteristics

Remote programming	
Interfaces	GPIB IEEE-488.2, 1987 with listen and talk LAN 1000BaseT LAN interface, LXI Class C compliant USB Version 2.0
Control languages	SCPI Version 1997.0
Compatibility languages	Keysight: N5181A\61A, N5182A\62A, N5183A, E4438C, E4428C, E442xB, E443xB, E8241A, E8244A, E8251A, E8254A, E8247C, E8257C/D, E8267C/D, 8648 series, 8656B, E8663B, 83711B/12B, 83731B/32B, 83751B/52B, 8340B/41B, 836xx series, 8664A, 8665A/B, 8644A, 8662A/63A
	Aeroflex Incorporated: 3410 series
	Rohde & Schwarz: SMR, SMF100A, SMB100A, SMBV100A, SMU200A, SMJ100A, SMATE200A, SMIQ, SML, SMV
	Anritsu: MG369x\A/B/C
Power requirements	
100/120 VAC, 50/60/400 Hz 220/240 VAC, 50/60 Hz 280 Watts maximum	
Operating temperature range	
0 to 55 °C	
Storage temperature range	
-40 to 70 °C	
Operating and storage altitude	
Up to 4,600 m	
Indoor use	
For indoor use only.	
Humidity	
Maximum Relative Humidity (non-condensing): 95%RH up to 40°C, decreases linearly to 45%RH at 55°C. <sup>1</sup>	
Environmental stress	
Samples of this product have been type tested in accordance with the Keysight Technologies, Inc. Environmental Test Manual and verified to be robust against the environmental stresses of storage, transportation, and end-use; those stresses include but are not limited to temperature, humidity, shock, vibration, altitude, and power line conditions. Test Methods are aligned with IEC 60068-2 and levels are similar to MIL-PRF-28800F Class 3.	

1. From 40 °C to 55 °C, the maximum % Relative Humidity follows the line of constant dew point.

## Safety

Complies with the essential requirements of the European Low Voltage Directive as well as current editions of the following standards (dates and editions are cited in the Declaration of Conformity):

- IEC/EN 61010-1
- Canada: CSA C22.2 No. 61010-1
- USA: UL std no. 61010-1

## EMC

Complies with European EMC Directive 2004/108/EC

- IEC/EN 61326
- CISPR Pub 11 Group 1, class A
- AS/NZS CISPR 11
- ICES/NMB-001

## Memory

Memory is shared by instrument states, user data files, sweep list files, and other files. Option 006 instrument security allows storage of up to 8 GB. Depending on how the memory is utilized, a maximum of 1000 instrument states can be saved.

## Security (Option 006)

Option 006 “Removable memory card & Instrument security” allows the following:

- Removable 8 GB solid state memory (SD card) from rear pane.
- User can force all files to be stored only on external memory card including instrument states, user data files, sweep list files, and other files
- Memory sanitizing, memory sanitizing on power on, and display blanking

## Self-test

Internal diagnostic routines test most modules in a preset condition. For each module, if its node voltages are within acceptable limits, the module “passes” the test.

## Weight

N5173B-513/520: ≤ 14.5 kg (32 lb.) net, ≤ 29.5 kg (65 lb.) shipping

N5173B-532/540: ≤ 15.0 kg (33 lb.) net, ≤ 29.9 kg (66 lb.) shipping

## Dimensions

88 mm H x 426 mm W x 489 mm L (length includes rear panel feet)

(3.5 in H x 16.8 in W x 19.2 in L)

Max length (L) including RF connector tip to end of rear panel feet is 508 mm (20 in)

## Recommended calibration cycle

36 months

## ISO compliant

This instrument is manufactured in an ISO-9001 registered facility in concurrence with Keysight's commitment to quality.

## Inputs and Outputs

Front panel connectors (all connectors are BNC unless otherwise stated)	
RF output	<b>Output impedance 50 Ω (nom)</b>
Option 513/520	Precision APC-3.5 male, or Type- N with Option 1ED
Option 532/540	Precision 2.4 mm male; plus 2.4—2.4 mm and 2.4-2.9 mm female adapters
Maximum reverse power	0.5 W, 0 Vdc
USB 2.0	Used with a memory stick for transferring instrument states, licenses and other files into or out of the instrument. Also used with U2000 Series USB average power sensors.
Rear panel connectors	
Rear panel inputs and outputs are 3.3 V CMOS, unless indicated otherwise. CMOS inputs will accept 5 V CMOS, 3 V CMOS, or TTL voltage levels.	
RF output (1EM)	<ul style="list-style-type: none"> <li>• <b>Output impedance 50 Ω (nom)</b></li> <li>• Option 513/520: Precision APC-3.5 male, or Type- N with option 1ED</li> <li>• Option 532/540: Precision 2.4 mm male; plus 2.4—2.4 mm and 2.4-2.9 mm female adapters</li> </ul>
Sweep out	Generates output voltage, 0 to +10 V when the signal generator is sweeping. This output can also be programmed to indicate when the source is settled or output <b>pulse video</b> and is <b>TTL and CMOS compatible in this mode</b> . <b>Output impedance &lt; 1 Ω, can drive 2 kΩ. Damage levels are ± 15 V.</b>
Ext1	External AM/FM/PM #1 input: Nominal input impedance is <b>50 Ω/600 Ω/1MΩ nominal</b> : Damage levels are ± 5 V.
Ext2	<b>External AM/FM/PM #2 input: Nominal input impedance is 50 Ω/600 Ω/1MΩ nominal</b> : Damage levels are ± 5 V.
Pulse	External pulse modulation input. This input is TTL and CMOS compatible. Low logic levels are 0 V and high logic levels are +1 V. Nominal input impedance is 50 Ω. <b>Input damage levels are ≤ -0.3 V and ≥ +5.3 V.</b>
Trigger 1 (in)	Accepts TTL and CMOS level signals for triggering point-to-point in sweep mode. <b>Damage levels are ≤ -0.3 V and ≥ +5.3 V.</b>
Trigger 2 (out)	Default use is with sweep mode. The signal is high at start of dwell, or when waiting for point trigger in manual sweep mode; low when dwell is over or point trigger is received. This output can also be programmed to indicate when the source is settled, <b>pulse synchronization, or pulse video</b> . <b>Outputs a 2.5V into 50 Ω nominal. Input damage levels are ≤ -0.3 V and ≥ +5.3 V.</b>
Reference input	Accepts a 10 MHz reference signal used to frequency lock the internal time base. Option 1ER adds the capability to lock to a frequency from 1 MHz to 50 MHz. Nominal input level <b>-3.5 to +20 dBm, impedance 50 Ω, sine or square waveform.</b>
10 MHz out	Outputs the 10 MHz reference signal used by internal timebase. Level nominally <b>+5 dBm. Nominal output impedance 50 Ω. Input damage level is +16 dBm.</b>
ALC in	This female BNC connector is used for negative external detector leveling. <ul style="list-style-type: none"> <li>• <b>Input impedance: 100 kΩ (nominal)</b></li> <li>• Signal levels: -0.2 mV to -0.5 V</li> <li>• Damage levels: &lt; -12 V and &gt; 1 V</li> </ul>

## Rear panel connectors

Rear panel inputs and outputs are 3.3 V CMOS, unless indicated otherwise. CMOS inputs will accept 5 V CMOS, 3 V CMOS, or TTL voltage levels.

Z-Axis output	This female BNC connector supplies a +5 V (nominal) level during retrace and band switch intervals of a step or list sweep. During step or list sweep, this connector supplies a –5 V (nominal) level when the RF frequency is at a marker frequency and <b>intensity marker mode is on. The load impedance should be <math>\geq 5\text{ k}\Omega</math>.</b>
USB Type-A	There are two USB 2.0 Type-A connectors on the rear panel. Used with a memory stick for transferring instrument states, licenses and other files into or out of the instrument; also used with U2000 Series USB power sensors.
USB Type-B	There is one USB 2.0 Type-B connectors on the rear panel. The USB connector provides remote programming functions via SCPI.
LAN (1000 BaseT)	The LAN connector provides the same SCPI remote programming functionality as the GPIB connector. The LAN connector is also used to access the internal web server and FTP server. The LAN supports DHCP, sockets SCPI, VXI-11 SCPI, connection monitoring, dynamic hostname services, TCP keep alive. This interface is LXI class C compliant. Trigger response time for the immediate LAN trigger is 0.5 ms (minimum), 4 ms (maximum), 2 ms (typ); delayed/alarm trigger is unknown. Trigger output response time is 0.5 ms (minimum), 4 ms (maximum), 2 ms typical.
GPIB	The GPIB connector provides remote programming functionality via SCPI.

## Related Literature

### Keysight X-Series Signal Generators

*MXG Microwave Signal Generator Data Sheet* [5991-3131EN](#)

*X-Series Signal Generator Technical Overview* [5990-9957EN](#)

## Confidently Covered by Keysight Services

Prevent delays caused by technical questions, or system downtimes due to instrument maintenance and repairs with Keysight Services. Keysight Services are here to support your test needs with expert technical support, instrument repair and calibration, software support, training, alternative acquisition program options, and more.

A KeysightCare agreement provides dedicated, proactive support through a single point of contact for instruments, software, and solutions. KeysightCare covers an extensive group of instruments, application software, and solutions and ensures optimal uptime, faster response, faster access to experts, and faster resolution.

### Keysight Services

Offering	Benefits
<b>KeysightCare</b> 	KeysightCare provides elevated support for Keysight instruments and software, with access to technical support experts that respond within a specified time and ensure committed repair and calibration turnaround times (TAT). KeysightCare offers multiple service agreement tiers, including KeysightCare Assured, Enhanced, and Application Software Support. See the <a href="#">KeysightCare data sheet</a> for details.
KeysightCare Assured	KeysightCare Assured goes beyond basic warranty with repair services that include committed TAT and unlimited access to technical experts.
KeysightCare Enhanced	KeysightCare Enhanced includes all the benefits of KeysightCare Assured plus Keysight's accurate and reliable calibration services, accelerated, and committed TAT, and technical response.
<b>Keysight Support Portal &amp; Knowledge Center</b>	All KeysightCare tiers include access to the Keysight Support Portal where you can manage support and service resources related to your assets such as service requests, and status, or browse the Knowledge Center.
<b>Education Services</b>	Build confidence and gain new skills to make accurate measurements, with flexible Education Services developed by Keysight experts. Including Start-up Assistance.
Alternative product acquisition	
<b>KeysightAccess</b>	Reduce budget challenges with a subscription service enabling you to get the instruments, software, and technical support you want for your test need s.

## Recommended Services

Maximize your test system up-time by securing technical support, repair, and calibration services with committed response and turnaround times. 1-year KeysightCare Assured is included in every new instrument purchase. Obtain multi-year KeysightCare upfront to eliminate the need for lengthy and tedious paperwork and yearly requests for maintenance budget. Plus, you benefit from secured service for 2, 3, or 5 years.

Service	Function
<b>KeysightCare Enhanced*</b>	<b>Includes Tech Support, Warranty and Calibration</b>
R-55B-001-1	KeysightCare Enhanced – Upgrade 1 year
R-55B-001-2	KeysightCare Enhanced – Extend to 2 years
R-55B-001-3	KeysightCare Enhanced – Extend to 3 years (Recommended)
R-55B-001-5	KeysightCare Enhanced – Extend to 5 years (Recommended)
<b>KeysightCare Assured</b>	<b>Includes Tech Support and Warranty</b>
R-55A-001-2	KeysightCare Assured – Extend to 2 years
R-55A-001-3	KeysightCare Assured – Extend to 3 years
R-55A-001-5	KeysightCare Assured – Extend to 5 years
<b>Start-Up Assistance</b>	
PS-S10	Included – instrument fundamentals and operations starter
PS-S20	Optional, technology & measurement science standard learning

\*Available in select countries. For details, please view the [datasheet](#). R-55B-001-2/3/5 must be ordered with R -55B-001-1.



Mess- und Prüftechnik. Die Experten.

**Ihr Ansprechpartner /  
Your Partner:**

**dataTec AG**  
E-Mail: [info@datatec.eu](mailto:info@datatec.eu)  
>>> [www.datatec.eu](http://www.datatec.eu)



Learn more at: [www.keysight.com](http://www.keysight.com)

For more information on Keysight Technologies' products, applications, or services, please contact your local Keysight office. The complete list is available at: [www.keysight.com/find/contactus](http://www.keysight.com/find/contactus)

Find us at [www.keysight.com](http://www.keysight.com)

This information is subject to change without notice. © Keysight Technologies, 2019 - 2023, Published in USA, February 8, 2023, 5991-3132EN