

AP5002A Microwave Analog Signal Generator

9 kHz to 12, 20, or 26 GHz



Mess- und Prüftechnik. Die Experten.

Ihr Ansprechpartner /
Your Partner:

dataTec AG
E-Mail: info@datatec.eu
>>> www.datatec.eu

 **KEYSIGHT**
Authorized Premium
Distributor

Definitions and Conditions

The specifications in the following pages describe the warranted performance of the instrument for $23 \pm 5 \text{ }^\circ\text{C}$ after a 30-minute warm-up period (unless otherwise stated).

Min/Max: Parameter range that is guaranteed by product design, and/or production tested. Warranted performance specifications include guard-bands to account for the expected statistical performance distribution, measurement uncertainties, and changes in performance due to environmental conditions.

Typical: Expected mean values, not warranted performance.

Specifications

Frequency parameters / range

Parameter	Min	Typical	Max	Note
Frequency range	9 kHz		12.0 GHz	AP5002A-512
	9 kHz		20.0 GHz	AP5002A-520
	9 kHz		26.0 GHz	AP5002A-526
Resolution		0.001 Hz		
Phase resolution		0.1 deg		
Frequency / Amplitude settling time		200 μs	300 μs	
Internal reference frequency		100 MHz		
Initial accuracy of internal reference			± 40 ppb	calibrated at $23 \pm 3 \text{ }^\circ\text{C}$ at the time of calibration, user adjustable
Temperature stability (0 to $50 \text{ }^\circ\text{C}$)			± 100 ppb	
Aging 1 st year		0.5 ppm		
Aging per day (after 30 days of operations)			5 ppb	
Warm-up time		5 min		
Output of internal reference	10 MHz		100 MHz	Both 10 MHz and 100 MHz reference output are available on the REF OUT port.
Output power		0 dBm		
Output impedance		50 Ω		
Bypass internal reference input	100 MHz, -5 to +10 dBm			High phase synchronous mode
Phase lock to external reference				
External input range	1 MHz		250 MHz	User programmable
Reference input level	-5 dBm	0 dBm	+13 dBm	
Lock range			± 1.5 ppm	
Reference input impedance		50 Ω		

Level performance

Parameter	Min	Typical	Max	Note
Power level				
Standard	-20 dBm		+15 dBm	9 kHz to 26 GHz
With Option 1E1	-120 dBm		+15 dBm	9 kHz to 26 GHz
With Option 1EA	-20 dBm		+15 dBm	9 kHz to 100 kHz
	-20 dBm		+20 dBm	100 kHz to 10 MHz
	-20 dBm		+23 dBm	10 MHz to 7.5 GHz
	-20 dBm		+20 dBm	7.5 to 20 GHz
	-20 dBm		+18 dBm	20 to 24 GHz
	-20 dBm		+14 dBm	24 to 26 GHz
	With Option 1E1 and 1EA	-120 dBm		+15 dBm
-120 dBm			+20 dBm	100 kHz to 10 MHz
-120 dBm			+23 dBm	10 MHz to 7.5 GHz
-120 dBm			+20 dBm	7.5 to 20 GHz
-120 dBm			+18 dBm	20 to 24 GHz
-120 dBm			+14 dBm	24 to 26 GHz
Resolution		0.01 dB		
Level uncertainty (ALC on, flatness correction: up to 2,000 points, temperature effects: 0.015 dB/ °C (typical) in range 0 to 45 °C)				
Power range	>+15 dBm to P_{max}	-15 to +15 dBm	-70 to -15 dBm	<-70 dBm
9 kHz to 10 GHz	± 1.6 dB, ± 0.8 dB typ.	± 1.0 dB, 0.3 dB typ.	± 1.5 dB, ± 0.4 dB typ.	± 1.8 dB, ± 0.5 dB typ.
10 GHz to f_{max}	± 1.6 dB, ± 0.8 dB typ.	± 1.0 dB, 0.3 dB typ.	± 1.5 dB, ± 0.4 dB typ.	± 2.0 dB, ± 0.5 dB typ.

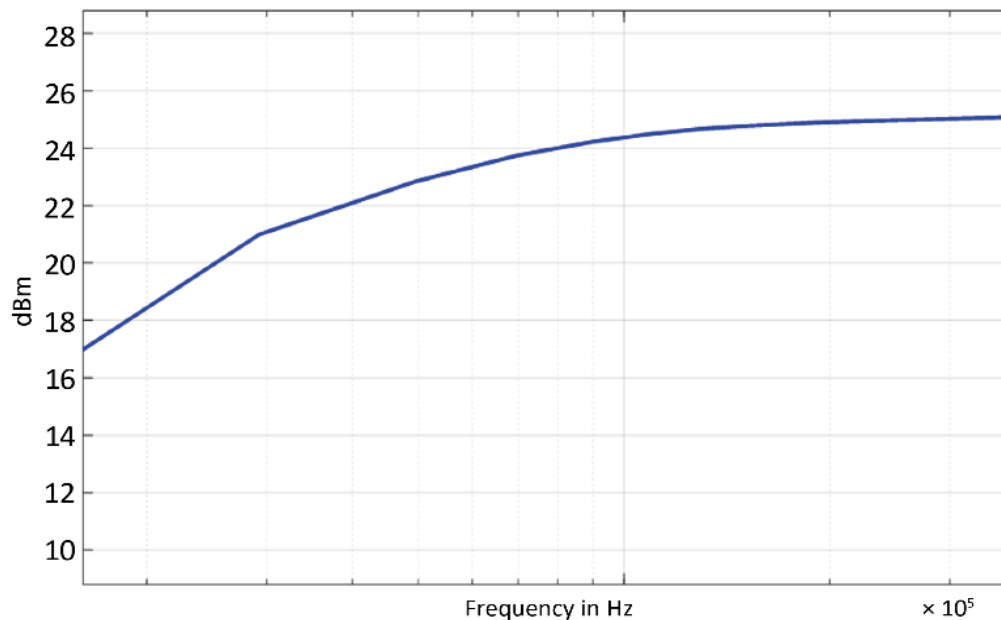

Figure 1. Typical maximum output power, 9 kHz to 1 MHz, with Option 1EA

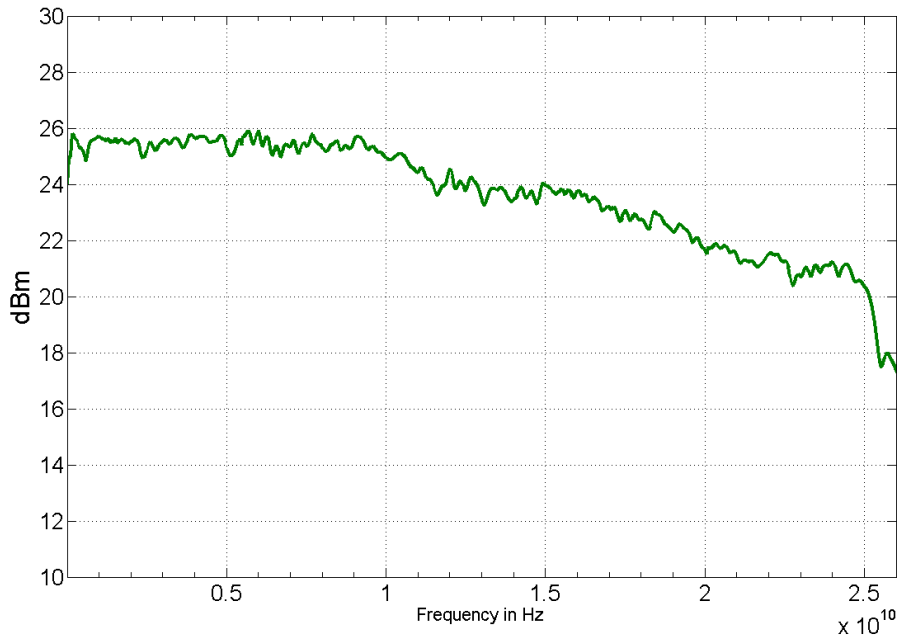

Figure 2. Typical maximum output power, 100 kHz to 26 GHz, with Option 1EA

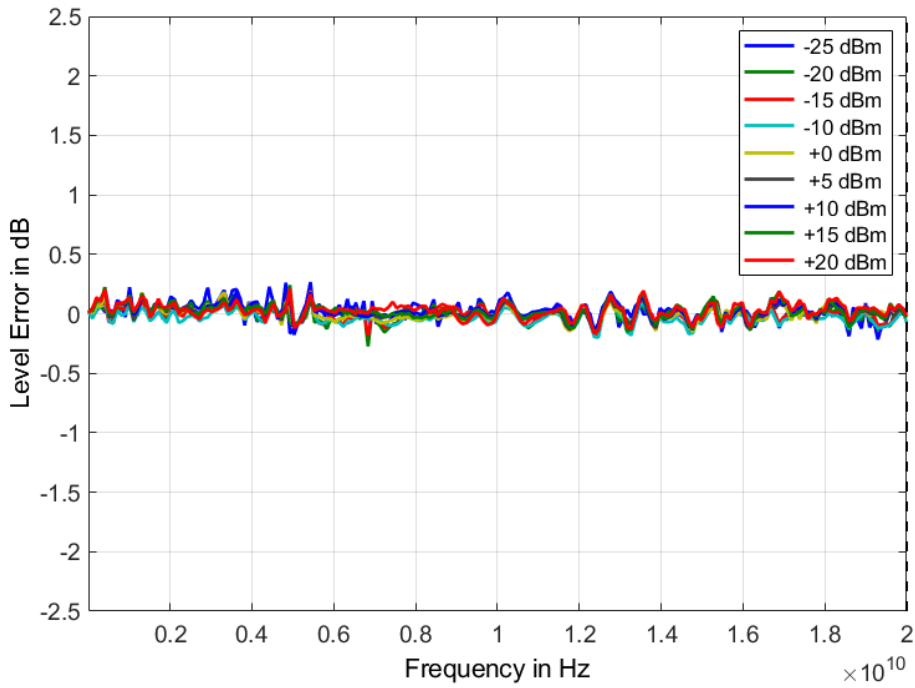

Figure 3. Typical frequency response, 0 to 20 GHz, at -20, 0, and +20 dBm

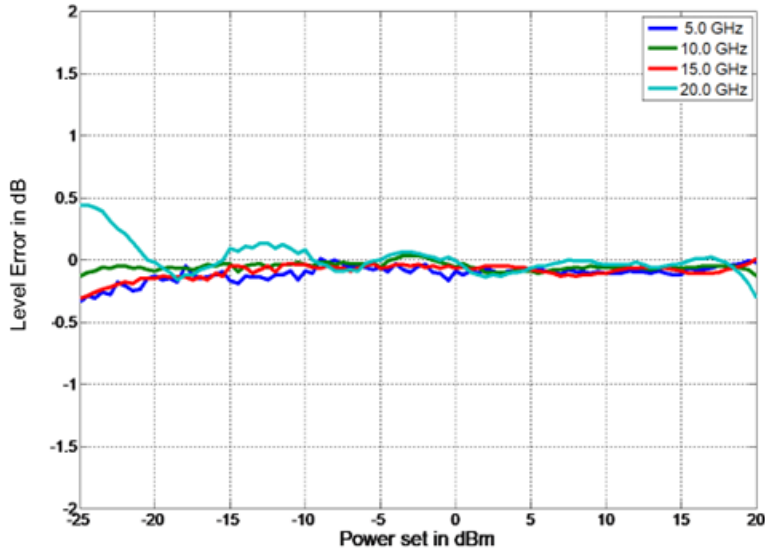

Figure 4. Absolute power level error, 0 to 20 GHz, at -20, 0, and +20 dBm

Reverse power protection and VSWR

Parameter	Min	Typical	Max	Note
Reverse Power Protection				
DC Voltage			5 V	
RF power			+27 dBm	
Output impedance		50 Ω		
VSWR		1.5		< 20 GHz
		2.0		> 20 GHz

Phase noise

Parameter	Min	Typical	Max	Note
SSB Phase noise				
1 GHz, 10 Hz offset		-80 dBc/Hz	-77 dBc/Hz	
1 GHz, 20 kHz offset		-130 dBc/Hz	-128 dBc/Hz	
1 GHz, 100 kHz offset		-131 dBc/Hz	-129 dBc/Hz	
4 GHz, 10 Hz offset		-68 dBc/Hz	-65 dBc/Hz	
4 GHz, 20 kHz offset		-118 dBc/Hz	-116 dBc/Hz	
4 GHz, 100 kHz offset		-119 dBc/Hz	-117 dBc/Hz	
20 GHz, 10 Hz offset		-51 dBc/Hz	-48 dBc/Hz	
20 GHz, 20 kHz offset		-104 dBc/Hz	-102 dBc/Hz	
20 GHz, 100 kHz offset		-104 dBc/Hz	-100 dBc/Hz	
Wideband noise		-150 dBc/Hz		
Amplitude Noise at 10 GHz		-130 dBc/Hz		

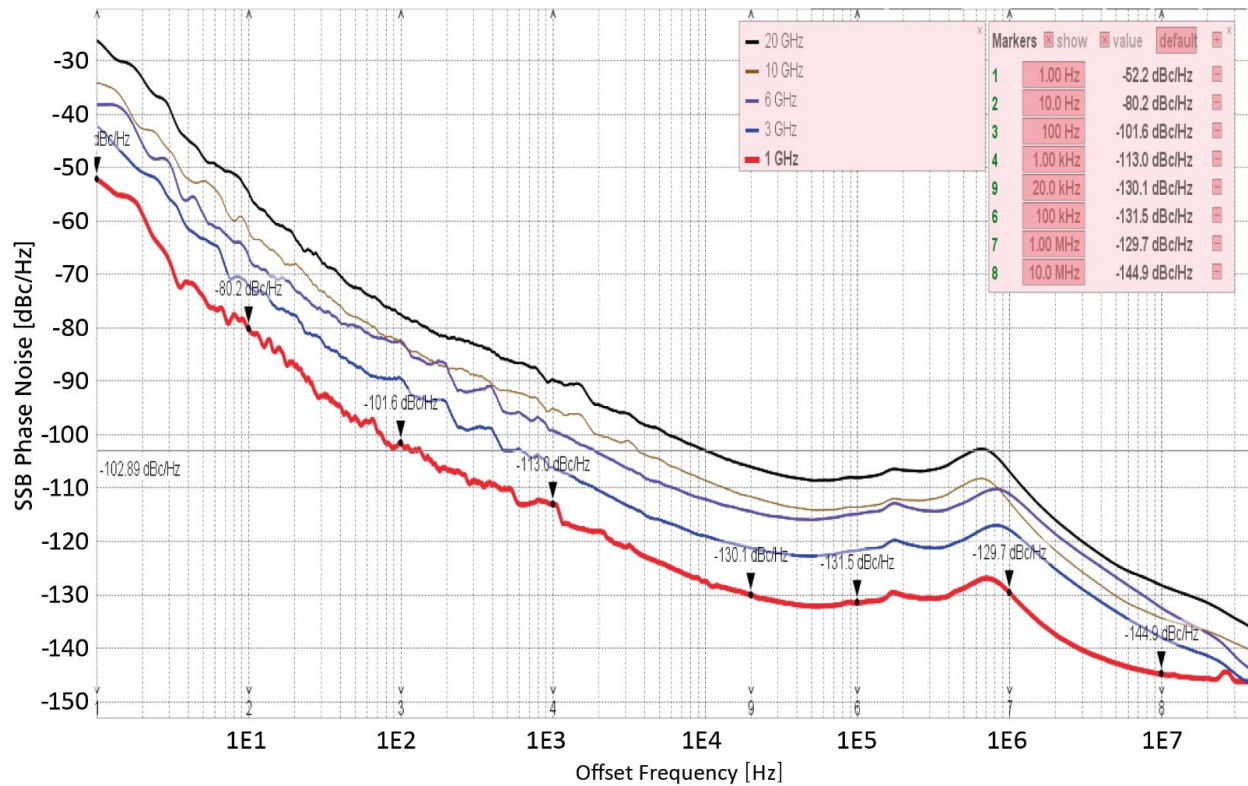

Figure 5. Typical phase noise at different frequencies, 1 Hz to 100 MHz offset

Spectral purity

Parameter	Min	Typical	Max	Note
Output harmonics		-40 dBc	-30 dBc	$P_{out} = +5$ dBm
Sub-harmonics		-75 dBc	-65 dBc	< 20 GHz
		-50 dBc	-40 dBc	> 20 GHz
Non-harmonic spurious (CW +10 dBm, > 3 kHz offset)				
< 312 MHz		-80 dBc	-66 dBc	
> 312 to 625 MHz		-75 dBc	-70 dBc	
> 625 MHz to 1.5 GHz		-75 dBc	-65 dBc	
> 1.5 to 2.5 GHz		-70 dBc	-65 dBc	
> 2.5 to 5 GHz		-65 dBc	-60 dBc	
> 5 to 10 GHz		-60 dBc	-55 dBc	
> 10 to 20 GHz		-55 dBc	-50 dBc	
> 20 GHz		-50 dBc	-45 dBc	
Residual FM at 10 GHz		15 Hz		0.3 kHz to 3 kHz, weighted, (ITU-T), RMS
Residual AM at 10 GHz		0.02%		RMS value (0.01 kHz to 15 kHz)

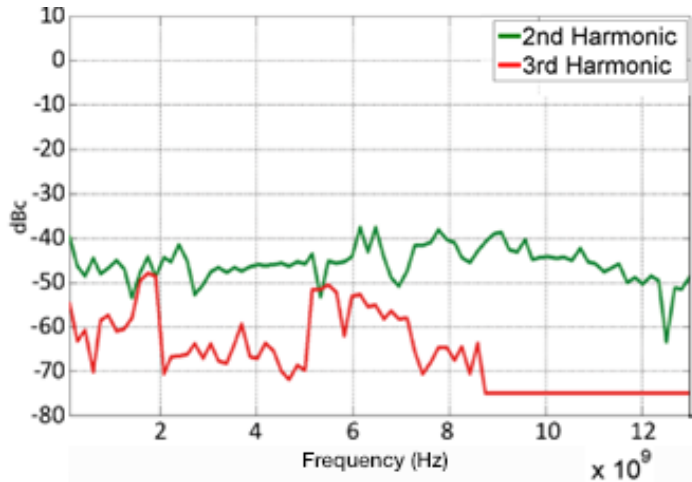

Figure 6. Typical harmonics

Sweeping capability

Sweeps can be performed with combined internal or external AM/FM/PM/pulse modulation running. With modulation enabled, the minimum step time increases to 2 ms.

Parameter	Min	Typical	Max	Note
Digital power / frequency / list sweep (Sweep type: linear, logarithmic, random)				
Step time (t_{step})	400 μ s		19998 s	
Dwell time (t_{dwell})	10 μ s		9999 s	
Off-time (incl. transient time) (t_{off})	0		9999 s	
Transient time (t_{inv})			270 μ s	
Timing delay (t_{de})		2 to 10 μ s		
Time resolution		0.1 μ s		
Timing accuracy per point		3 μ s		

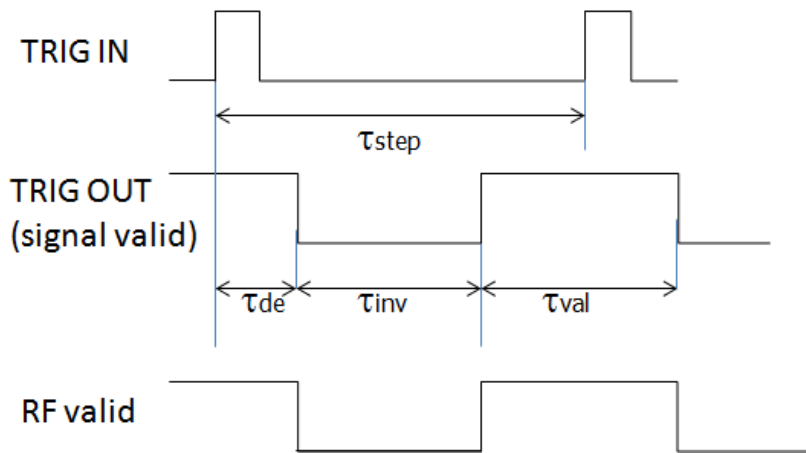

Figure 7. Timing diagram

Modulation capabilities

All modulation types (FM, PM, AM, and pulse modulation) may be enabled simultaneously except that FM and phase modulation cannot be combined. For example, AM and FM can run concurrently and will modulate the output RF.

Parameter	Min	Typical	Max	Note
Pulse modulation				
On/off ratio		75 dB typical		at +10 dBm
Repetition frequency	DC		10 MHz	
Pulse width	100 ns 500 ns		5 s 5 s	ALC hold ALC on
Pulse rise/fall time		30 ns 5 ns		<5 GHz >5 GHz
Duty cycle	0.05%		99.95%	
Pulse resolution		30 ns		
Polarity		selectable		
External input threshold	0.85 V	0.9 V	0.95 V	TTL compatible
External input voltage range	-0.5 V		+5.5 V	TTL compatible
External input hysteresis		60 mV		
Delay (to RF)		20 ns	40 ns	
Pulse Pattern Modulation				
Pulse bit width	100 ns 500 ns			ALC hold ALC on
Programmable pattern length	2		4096	
Duty cycle	0.05%		99.95%	
Pulse bit resolution		30 ns		
Polarity		selectable		
Frequency Modulation				
Maximum Frequency deviation (peak)	0 0		0.05 x f N x 200 MHz	< 0.5 GHz 0.5 to 2.5 GHz (N=0.125) 2.5 to 5 GHz (N=0.25) 5 to 10 GHz (N=0.5) > 10 GHz to 26 GHz (N=1)
Deviation accuracy		0.5% 2%	2% 5%	< 100 kHz rate > 100 kHz rate
Distortion		< 1%		1 kHz rate, 50 kHz deviation
Modulation rate	DC		100 kHz	> -3 dB frequency response
Modulation waveforms	Sine, triangle, FSK			
External input sensitivity	0 to N x 200 MHz / V, AC coupled			adjustable for ±1 V range
	0 to N x 100 MHz / V, DC coupled			Discrete values; ±5 V range
Total harmonic distortion	< 1%			1 kHz rate & N x 1 MHz deviation

Parameter	Min	Typical	Max	Note
Frequency chirps (linear ramp, up/down)				
Span	10%			of carrier frequency
Chirp time (t_{chirp})	10 ns		60 s	
Slope			100 MHz/ μ s	
Total duration of finite repeated chirps (t_{chirp} x repetitions)			64.1 s	
Number of frequencies			65,000	
Phase modulation				
Phase deviation (peak)	0		N x 300 rad	
Modulation rate	DC		100 kHz	> -3 dB frequency response Max. phase deviation degrades above 20 kHz modulation rate
Modulation waveforms	Sine, triangle, FSK			
External Input sensitivity	Settable 0.1 rad/V to 360 rad/V			
Total harmonic distortion	< 1%			1 kHz rate & N x 100 rad deviation
Amplitude modulation				
Modulation rate	0.1 Hz		50 kHz	
Modulation depth	0%		100%	settable
Modulation waveforms	Sine, triangle, square			
Accuracy (f>10 MHz)		0.8%	1.4%	f-carrier, modulation depth <80% & 1 kHz modulation rate, power 0 dBm
Distortion (f>10 MHz)		1%	2%	
External Input range	0 V		5 V	to GND

Multi-purpose output (FUNC OUT)

Parameter	Min	Typical	Max	Note
Multifunction generator (sine, triangle, square wave)				
Frequency range	10 Hz		3 MHz	sine
	10 Hz		1 MHz	triangle
	10 Hz		50 kHz	square
Frequency resolution		0.1 Hz		
Output voltage amplitude peak-peak	10 mV		2 V	sine, triangle
		5V		square (CMOS output)
Harmonic distortion		1 %		< 100 kHz, 1 Vpp
Output impedance		50 Ω		sine, triangle
		CMOS		square
Video output (of internal pulse modulator)				
Output		CMOS		
Period	30 ns		50 s	
Pulse Width	15 ns		50 s	
RF delay		10 ns		
Trigger out (Synchronization mode for multiple sources)				
Modes	Trigger on sweep start			
	Trigger on each point			

Trigger (TRIG IN)

Parameter	Min	Typical	Max	Note
Trigger types	Continuous, single, gated, gated direction			
Trigger source	RF key, external, bus (LAN, USB)			
Trigger modes	Continuous free run, trigger and run, reset and run			
Trigger latency		2 μs		
Trigger uncertainty		5 μs		
External trigger delay	50 μs		40 s	programmable
External delay resolution		15 ns		
Trigger modulo	1		255	Execute only on the N th trigger event
Trigger polarity	Rising, falling			
External trigger input threshold	0.85 V	0.9 V	0.95 V	TTL compatible
External trigger input voltage range	-0.5 V		+5.5 V	TTL compatible
External trigger input hysteresis		60 mV		

Connectors

Front

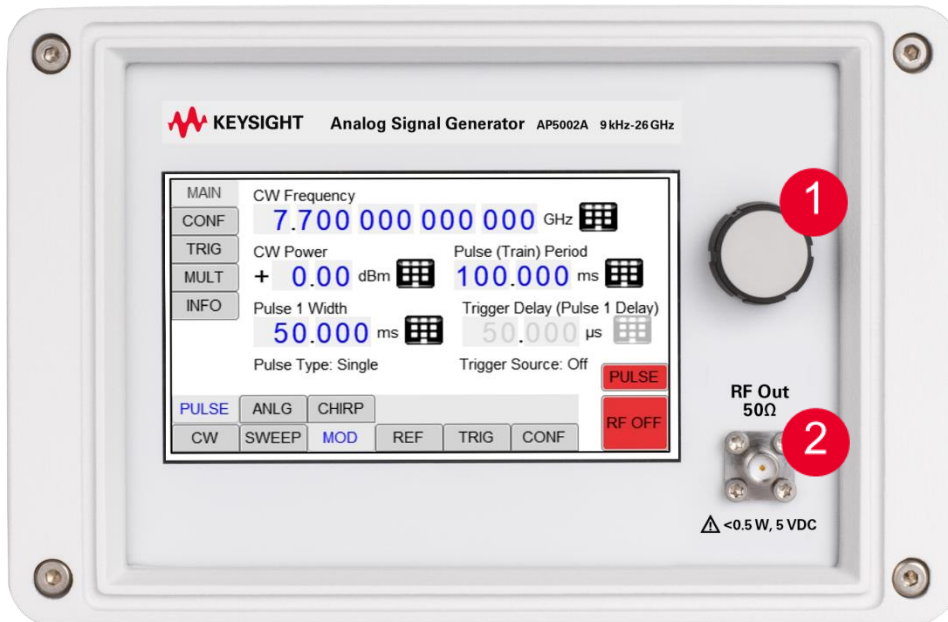

1. **Rotary Button** The rotary button is used to change the value selected on the screen.
2. **RF 50 Ω connector** The female SMA-type connector provides the output for generator signals. The impedance is 50 ohm.

Rear

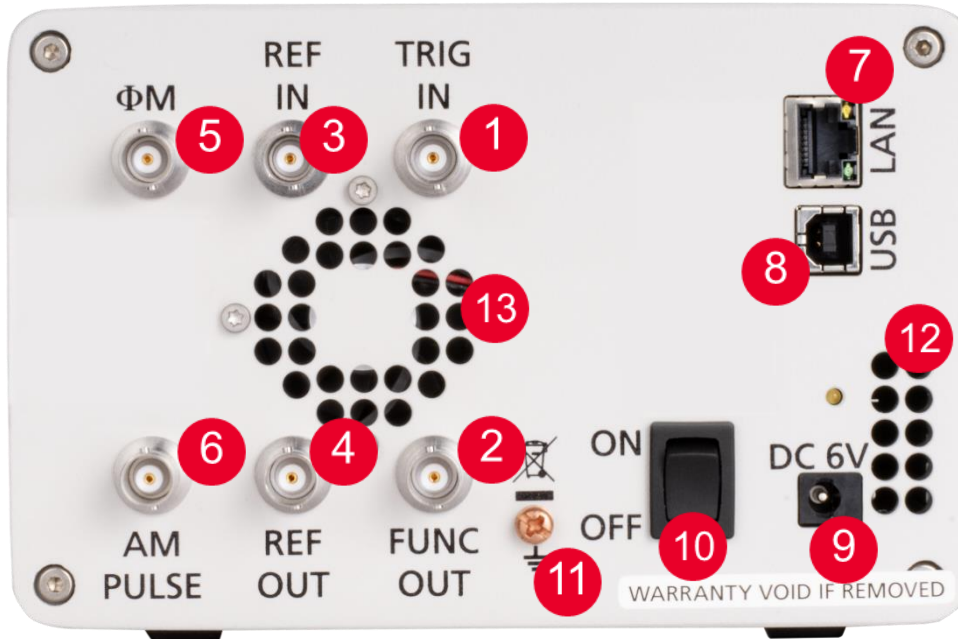

1. **TRIG IN** This BNC female Connector is the trigger input.
2. **FUNC OUT** This BNC female Connector is the output for the function signal.
3. **REF IN** This BNC female Connector is the input for the reference signal.
4. **REF OUT** This BNC female Connector is the output for the reference signal.
5. **ΦM** This BNC female Connector is the input for FM and PM.
6. **AM PULSE** This BNC female Connector is the input for the AM and the PULSE Modulation signal.
7. **LAN** The LAN connector is used to connect the device to a network.
8. **USB B** The USB B connector is used to connect the device to a computer.
9. **Power Supply** Connect the power adaptor to this connector to supply the device with energy.
10. **ON/OFF Switch** Turns the device on or off.
11. **Ground Screw**
12. **Fan Holes** The air intake of the fan.
13. **Fan Holes** The holes by which the air is extruded.

General Characteristics

Remote programming interfaces	Ethernet 100BaseT LAN interface USB 2.0 host & device Control language SCPI Version 1999.0
Power requirements:	6.25 ± 0.2 VDC; 20 W maximum
Mains adapter supplied:	100-240 VAC in/ 6 V 6.0 A DC out
Environmental (Levels similar to MIL-PRF-28800F Class 3/4)	Environmental stress Samples of this product have been type tested to be robust against the environmental stresses of storage, transportation, and end-use; those stresses to temperature, humidity, shock, vibration, altitude, and power line conditions.
Storage temperature range	-40 to 70 °C
Operating temperature range	0 to 45 °C
Max. Relative Humidity	85% up to 45°C ambient
Operating and storage altitude	up to 15,000 feet
	EMC complies and EMC regulations and directives for emission and immunity to interference (EN 61326-1 Industrial, EN/IEC 61326-2-1) Safety complies with applicable Safety regulation in line with IEC/EN 61010-1
Weight	≤ 2.5 kg (6 lbs) net, ≤ 4 kg (8 lb.) shipping
Dimensions	Including connectors: W x L x H = 174 x 262 x 117 mm [6.83 x 10.30 x 4.60 in]
Recommended calibration cycle	24 months
Compatibility languages supporting commonly used commands	Keysight N5171B EXG, N5173B EXG, N5181A/B MXG, N5183A/B MXG Rohde & Schwarz SMB100A, SMB100B, SMC100A, SMCV100B, SMA and SML models

Ordering information

Model/option	Description	Additional information
AP5002A	RF Microwave Signal Generator	
AP5002A-512	Frequency range, 9 kHz to 12 GHz	
AP5002A-520	Frequency range, 9 kHz to 20 GHz	
AP5002A-526	Frequency range, 9 kHz to 26 GHz	
AP5002A-1E1	Step attenuator	
AP5002A-1EA	High output power	
AP5002AU-F01	Frequency upgrade from 12 GHz to 20 GHz	License key only
AP5002AU-F02	Frequency upgrade from 12 GHz to 26 GHz	License key only
AP5002AU-F03	Frequency upgrade from 20 GHz to 26 GHz	License key only
AP5002AU-1E1	Add step attenuator	License key only
AP5002AU-1EA	Add high output power	License key only



Mess- und Prüftechnik. Die Experten.

**Ihr Ansprechpartner /
Your Partner:**

dataTec AG

E-Mail: info@datatec.eu

>>> www.datatec.eu



Keysight enables innovators to push the boundaries of engineering by quickly solving design, emulation, and test challenges to create the best product experiences. Start your innovation journey at www.keysight.com.

This information is subject to change without notice. © Keysight Technologies, 2024, Published in USA, August 29, 2024, 3124-1576.EN