

dataTec

Mess- und Prüftechnik. Die Experten.

**Ihr Ansprechpartner /
Your Partner:**

dataTec AG
E-Mail: info@datatec.eu
>>> www.datatec.eu



Authorized
Distributor



Product Brochure

PXI Electronic Load Modules

Contents

[PXI Electronic Load Modules](#)

[Detailed View](#)

[Key Features](#)

[Software](#)

[Supporting Documentation](#)

[Configure a Custom NI System](#)

[What is PXI?](#)

[PXI Instrumentation](#)

[Hardware Services](#)

PXI Electronic Load Modules

PXIe-4051



FIGURE 1

PXIe-4051 Electronic Load Module

- Software: Includes interactive InstrumentStudio™ soft front panel; API support for LabVIEW, C#/.NET, and Python; shipping examples; and detailed help files
- Voltage and current measurements with sample rates up to 1.8 MS/s and update rates up to 100 kS/s
- Ability to sink up to 300 W of DC power
- Hardware timing and triggering
- 4-wire remote sense
- Output disconnect feature

Built for Automated Test and Measurement

NI PXI Express electronic load modules (e-loads) sink up to 300 W in the compact form factor of a single PXI module. The high-power sinking and measurement capabilities simplify the task of designing automated test systems by saving expensive rack space and reducing the need for multiple instrument form factors within the test system. The fully programmable e-loads have output disconnect features to isolate the instrument from the DUT, remote sense to correct for losses in system wiring, and integrated timing and synchronization through the PXI platform. Combining these standard e-load features with a tightly integrated programming API and the PXI platform makes these instruments ideal for automated test applications in semiconductor, aerospace and defense, transportation, consumer electronics, and more.

Table 1. With NI PXI e-loads, you can sink DC power with high-accuracy measurements in a compact form factor optimized for design validation, characterization, and production test.

Feature	PXIe-4051
Quadrant of Operation	IV - Sinking (II if manually inverted)
Number of Isolated Channels	1
Number of PXI Slots	3
Maximum Voltage (V)	60
Maximum Current (A)	40
Maximum Power Per Channel (W)	300
Maximum Voltage Measurement Resolution (μV)	1
Maximum Voltage Measurement Accuracy (μV)	0.03% + 600
Maximum Current Measurement Resolution (μA)	10
Maximum Current Measurement Accuracy (μA)	0.05% + 700
Maximum Sampling Rate (MS/s)	1.8
Update Rate (kS/s)	100
Output Disconnect Feature	●
4-Wire Remote Sense	●
Hardware Timing and Triggering	●
SourceAdapt Custom Transient Response Tuning	●
Auxiliary Power Supply	Not Required
Chassis Compatibility	58 W, 82 W NI Chassis ¹ (Check specifications for full details)

¹The PXIe-4051 requires a PXIe-1095, PXIe-1092, or PXIe-1084 chassis for full 300 W capabilities.

Detailed View of a PXI Electronic Load

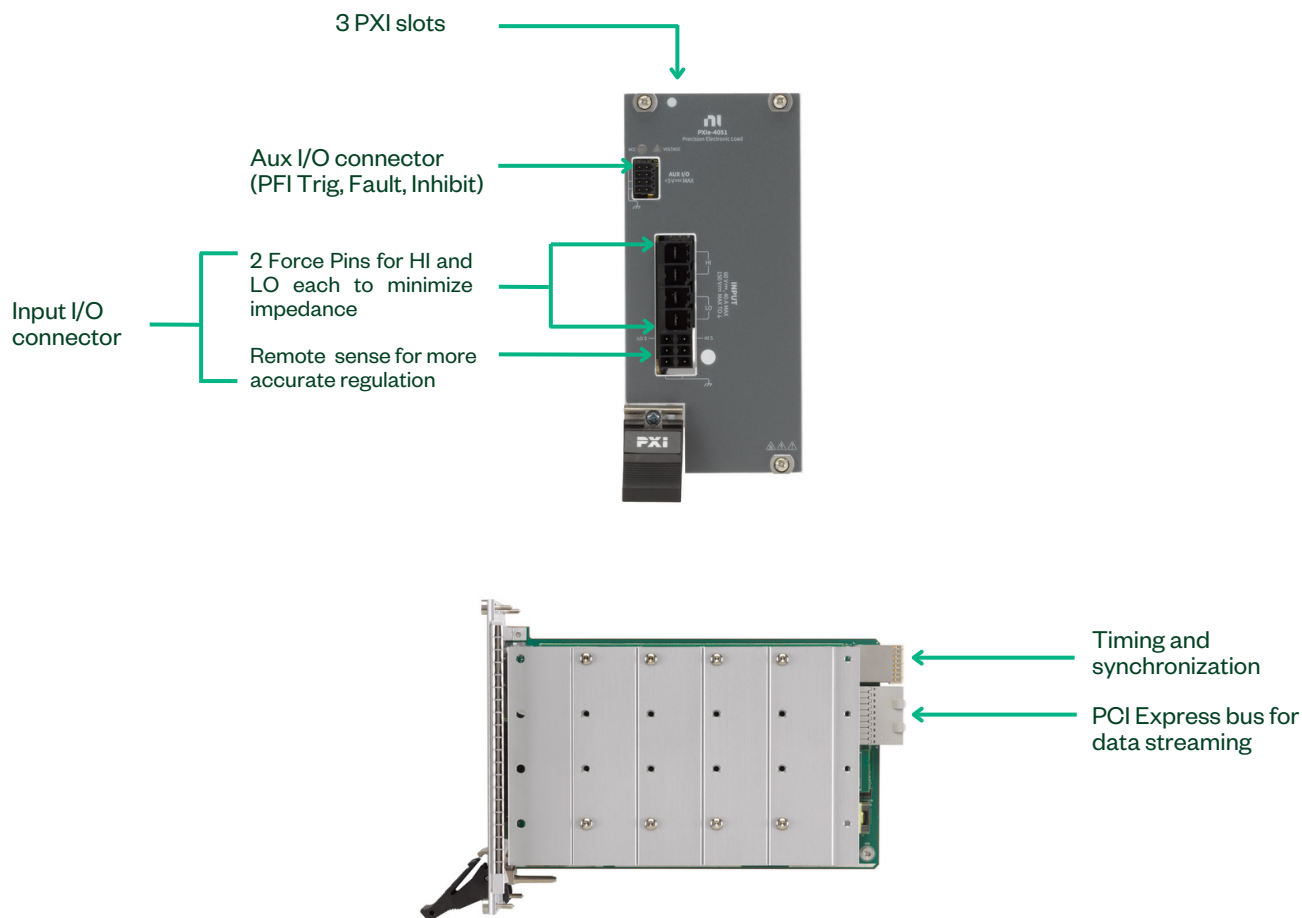

FIGURE 2
Detailed View of the PXIe-4051 E-load

Key Features

Accelerate Time to Insights

Get detailed insights thanks to the high accuracy of output values and simultaneous current and voltage measurements and perform fast e-load operations with the high data bandwidth and low latency of PXI. With PXI, data and commands are sent back and forth between the host rapidly, leading to faster data acquisition. Additionally, the e-load provides built-in DMM-like measurements up to 1.8 MS/s, preventing the need for an external DMM/scope in most applications. User-programmable source delay and aperture times give you the ability to optimize for both test time and measurement accuracy, and update rates up to 100 kS/s provide the ability to create custom, complex waveforms for even the most dynamic test requirements.

Achieve Higher Accuracy Using Measurement Ranges

NI PXI e-loads offer multiple measurement ranges for both voltage and current to maximize your measurement fidelity and reduce quantization noise. Using the different ranges, you can maximize the accuracy for large or small signals beyond what would be possible using just the full range. In other words, you can optimize the ADC range using the appropriate measurement range.

Operate at Low Voltages

An important aspect of any e-load is its low-voltage operation. NI PXI e-loads can be operated at maximum current starting at 500 mV. This voltage is considered the “minimum turn-on voltage.” This relationship is shown in Figure 3. Below the minimum turn-on voltage, current is derated linearly with voltage, and it is governed by the minimum resistance of the e-load, which is 12.5 m Ω .

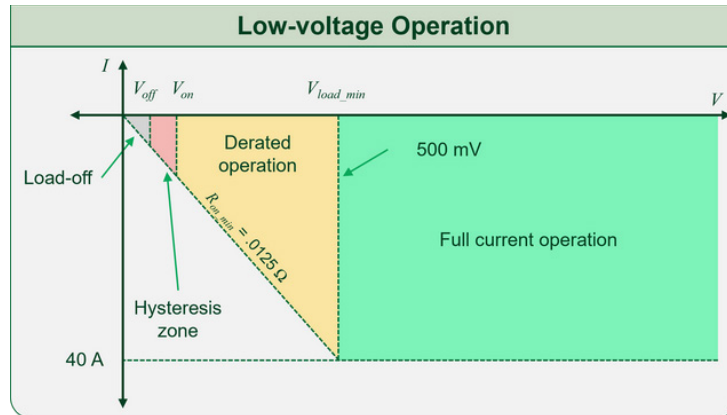

FIGURE 3

This I-V plot shows the current operation as a function of voltage and minimum resistance.

With PXI e-loads, you can also enable latching behavior during which the e-load stays on between some user-defined values of V_{on} and V_{off} . This threshold between the two values is known as the hysteresis zone, which is depicted in Figure 3 in red. When latching is enabled, the e-load turns off after dipping below V_{off} . However, if latching is disabled, the e-load turns on or off depending only on whether the voltage is above or below one user-defined value of V_{on} . The latching feature enables predictable turn-on behavior with these user-defined on and off voltages.

Customize the Transient Response to Any Load

NI SourceAdapt digital control-loop technology gives you the ability to optimize the instrument's or e-load's response for any DUT. This provides fast and stable measurements for a variety of loads, even highly capacitive or inductive loads, and prevents damage to your DUT by removing harmful overshoots and oscillations. By allowing complete customization of the instrument's or e-load's response, this technology helps you remove unwanted characteristics of the instrument while maintaining a fast settling time—all without adding any custom circuitry between the instrument and the load. Because this capability is handled programmatically, you can quickly reconfigure your instrument for high-speed or high-stability testing and maximize the usage of your instrument.

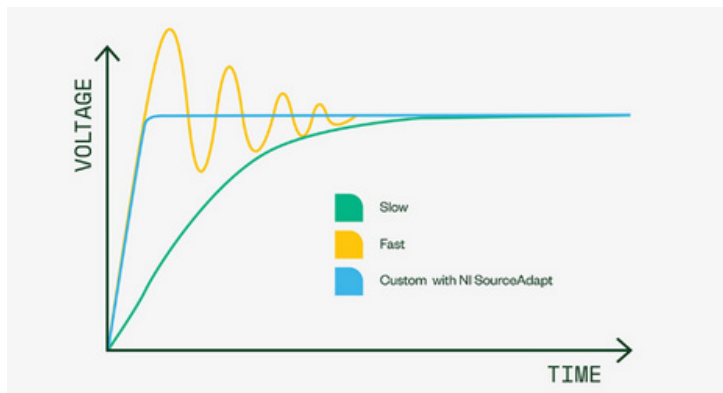

FIGURE 4

The plot of voltage versus time shows an unstable, slow, and optimized instrument response using SourceAdapt.

Use Remote Sense

NI PXI e-loads give you the flexibility to programmatically disconnect the output of the instrument and to configure local or remote sense for each channel. Programmatically disconnecting the output of the e-load allows you to isolate the instrument from your DUT without manually disconnecting the output. Remote sense uses a pair of high-impedance sense lines to measure the voltage at your DUT and compensate for any voltage drop between the terminals of the power supply and the DUT.

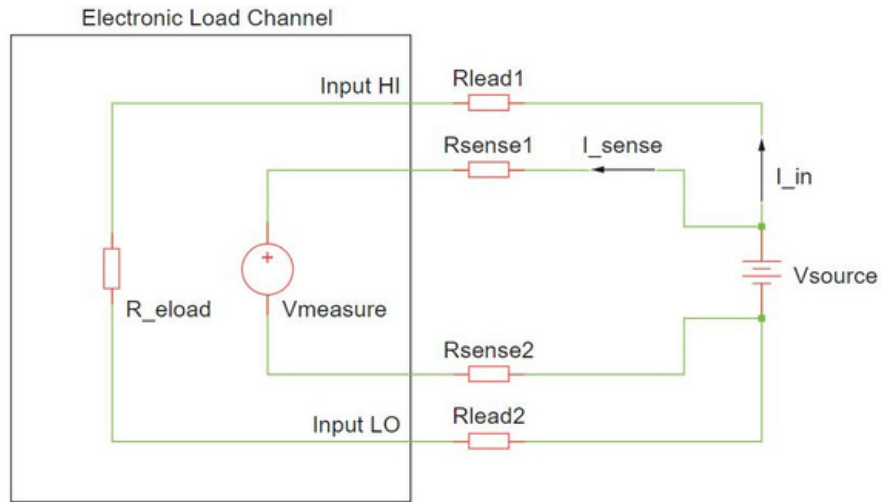

FIGURE 5
Connecting for a Remote Sense Measurement

Reduce Test Execution Time

NI e-loads have a hardware-timed, deterministic sequencing engine that allows the instrument to execute commands and acquire data without any intervention from the host software. This eliminates the software overhead and jitter associated with software-controlled sequences and reduces the execution time of your overall test. The timing engine also gives you the flexibility to repeat a sequence for a finite number of steps, or continuously source and measure for an infinite amount of time. Each instrument has numerous triggers and events, such as source trigger, measure trigger, and measure complete, that you can share via the backplane of the PXI chassis to communicate between different instruments. This allows you to synchronize the start of multiple power supplies, create nested sweeps, or send/receive commands from other instruments like oscilloscopes and RF analyzers.

Software

NI-DC Power API

In addition to the soft front panel in InstrumentStudio, the PXI power supplies and e-loads use the NI-DCPower driver, which includes a best-in-class API that works with a variety of development options such as LabVIEW, C/C++, C#, and others. To ensure long-term interoperability of source measure units (SMUs) and PXI programmable power instruments, the NI-DCPower driver API is the same API used for all past and current NI SMUs and PXI programmable power instruments. The driver also provides access to help files, documentation, and dozens of ready-to-run shipping examples you can use as a starting point for your application.

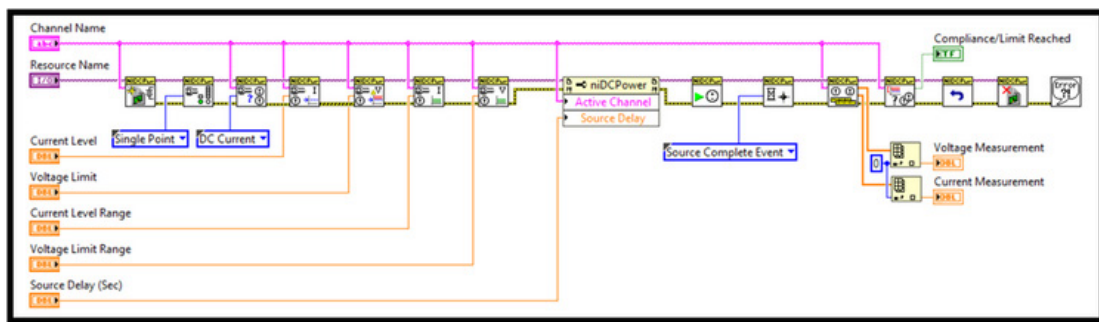
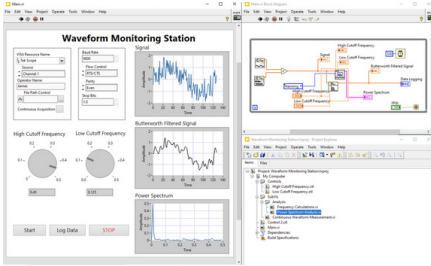

FIGURE 6
LabVIEW VI Using the NI-DCPower API

NI Software- The Right Tool for the Job

NI has a variety of software for engineers working on research, validation, and production test applications. Learn about our software that helps engineers perform quick ad-hoc tests, build an automated test system, automate data analysis and reporting, develop test sequences, and more.

LabVIEW



Graphical programming environment that engineers use to develop automated research, validation, and production test systems.

- Acquire data from NI and third-party hardware and communicate using industry protocols
- Use configurable, interactive display elements
- Take advantage of available analysis functions

DIAdem

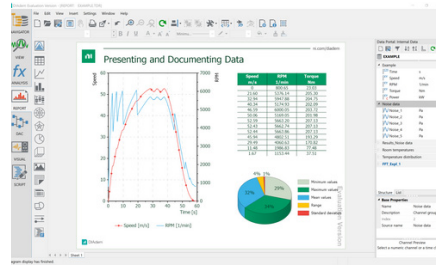

Data analytics software for measurement data search, inspection, analysis, and automated reporting.

- Display data in multiple 2D-axis systems
- Perform calculations with a simple point-and-click interface
- Automate your measurement data analysis workflow, from import to analysis

TestStand

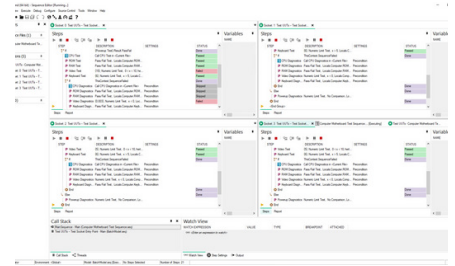

Test executive software that accelerates system development for engineers in validation and production.

- Call and execute tests in LabVIEW, Python, C/C++, or .NET
- Conduct complex tasks, such as parallel testing
- Create customer operator interfaces and robust tools for deployment and debugging

G Web

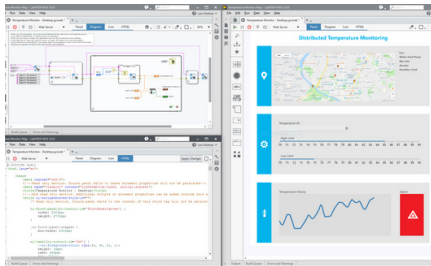

Development software that helps engineers create web-based user interfaces without the need for traditional web development skills.

- Data transfer APIs for connecting to systems written in LabVIEW, Python, or C#
- Pre-built objects for data display and user input
- Included hosting on SystemLink™ Cloud

FlexLogger™

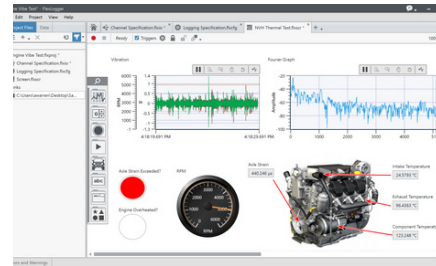

No-code data acquisition software engineers use to build validation and verification test applications.

- Interactive visualization tools for monitoring tests with drag-and-drop charts, graphs, and controls
- Ability to set alarms that monitor single channels or groups for unexpected behavior

InstrumentStudio™



Application software that simplifies setup and configuration of NI PXI hardware

- Customizable layouts for monitoring multiple instruments at once
- Interactively debug in tandem with code
- TDMS file export containing instrument settings, measurements, and raw data

Supporting Documentation

Table 2. PXI E-load Documentation

Document Type	Model
Getting Started Guide	PXIe-4051
Specifications	PXIe-4051

Configure a Custom NI System

NI's online system advisors help you create a custom system based on your specific requirements. Use the advisor to choose compatible hardware, software, accessories, and services and then save your selections as configurations for easy quoting and purchasing later. Visit ni.com/advisor to learn more.

What Is PXI?



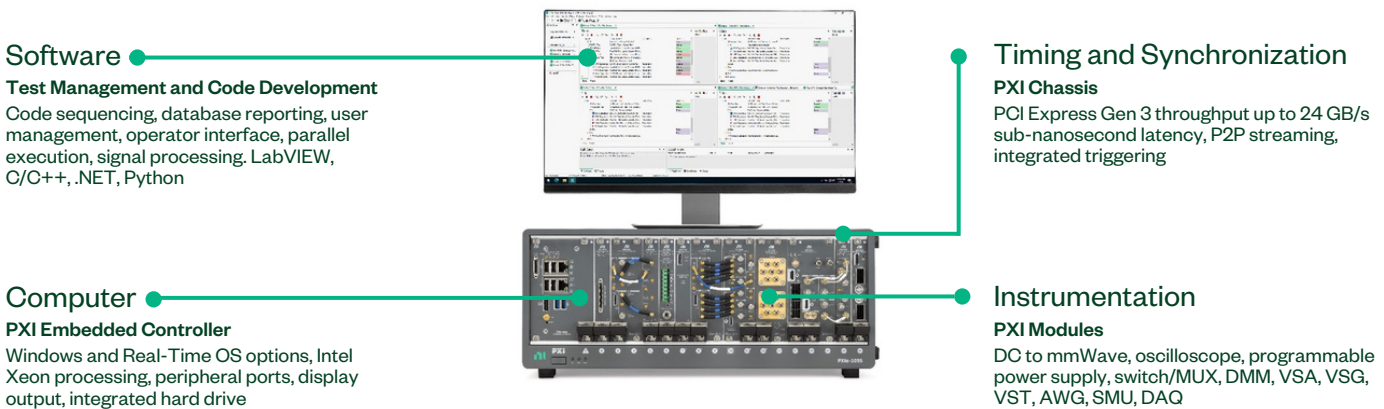

A Platform Approach to Test and Measurement

Powered by software, PXI is a rugged PC-based platform for measurement and automation systems. PXI combines PCI electrical-bus features with the modular, Eurocard packaging of CompactPCI and then adds specialized synchronization buses and key software features. PXI is both a high-performance and low-cost deployment platform for applications such as manufacturing test, military and aerospace, machine monitoring, automotive, and industrial test. Developed in 1997 and launched in 1998, PXI is an open industry standard governed by the PXI Systems Alliance (PXISA), a group of more than 70 companies chartered to promote the PXI standard, ensure interoperability, and maintain the PXI specification.



Integrated with the Latest Commercial Technology

By leveraging the latest commercial technology for our products, we can continually deliver high performance and high-quality products to our users at a competitive price. The latest PCI Express Gen 3 switches deliver higher data throughput, the latest Intel multicore processors facilitate faster and more efficient parallel (multisite) testing, the latest FPGAs from Xilinx help to push signal processing algorithms to the edge to accelerate measurements, and the latest data converters from TI and ADI continually increase the measurement range and performance of our instrumentation.

HIGHER DATA THROUGHPUT  PCI Express Gen 3	PARALLEL TEST EXECUTION  Multicore Processors	MEASUREMENT ACCELERATION  FPGAs	INCREASED MEASUREMENT RANGE  Data Converters
--	--	---	---

PXI Instrumentation

NI offers more than 600 different PXI modules ranging from DC to mmWave. Because PXI is an open industry standard, nearly 1,500 products are available from more than 70 different instrument vendors. With standard processing and control functions designated to a controller, PXI instruments need to contain only the actual instrumentation circuitry, which provides effective performance in a small footprint. Combined with a chassis and controller, PXI systems feature high-throughput data movement using PCI Express bus interfaces and sub-nanosecond synchronization with integrated timing and triggering.



Oscilloscopes

Sample at speeds up to 12.5 GS/s with 5 GHz of analog bandwidth, featuring numerous triggering modes and deep onboard memory



Digital Multimeters

Perform voltage (up to 1000 V), current (up to 3A), resistance, inductance, capacitance, and frequency/period measurements, as well as diode tests



Digital Instruments

Perform characterization and production test of semiconductor devices with timing sets and per channel pin parametric measurement unit (PPMU)



Waveform Generators

Generate standard functions including sine, square, triangle, and ramp as well as user-defined, arbitrary waveforms



Frequency Counters

Perform counter timer tasks such as event counting and encoder position, period, pulse, and frequency measurements



Source Measure Units

Combine high-precision source and measure capability with high channel density, deterministic hardware sequencing, and SourceAdapt transient optimization



Power Supplies & Loads

Supply programmable DC power, with some modules including isolated channels, output disconnect functionality, and remote sense



FlexRIO Custom Instruments & Processing

Provide high-performance I/O and powerful FPGAs for applications that require more than standard instruments can offer



Switches (Matrix & MUX)

Feature a variety of relay types and row/column configurations to simplify wiring in automated test systems



Vector Signal Transceivers

Combine a vector signal generator and vector signal analyzer with FPGA-based, real-time signal processing and control



GPIB, Serial, & Ethernet

Integrate non-PXI instruments into a PXI system through various instrument control interfaces



Data Acquisition Modules

Provide a mix of analog I/O, digital I/O, counter/timer, and trigger functionality for measuring electrical or physical phenomena

NI Hardware Services

All NI hardware includes a one-year warranty for basic repair coverage and calibration in adherence to NI specifications prior to shipment. PXI systems also include basic assembly and a functional test. NI offers additional entitlements to improve uptime and lower maintenance costs with service programs for hardware. Learn more at ni.com/services/hardware.

	Hardware	Standard	Premium	Description
Duration at Point of Sale	1 year; included	3 years; optional	3 years; optional	NI enhances warranty coverage with additional service benefits provided with a hardware service program.
Maximum Duration with Renewal	≤3 years with service program	≤3 years	≤3 years	NI maintains the high performance and availability of your hardware for up to three years with a hardware service program.
Extended Repair Coverage	•	•	•	NI restores your device's functionality and includes firmware updates and factory calibration; < 10 working days ⁴ + standard shipping.
System Configuration, Assembly, and Test ¹		•	•	NI technicians assemble, install software in, and test your system per your custom configuration prior to shipment.
Advanced Replacement ²			•	NI stocks replacement hardware that can be shipped immediately if a repair is needed.
System Return Material Authorization (RMA) ¹			•	NI accepts the delivery of fully assembled systems when performing repair services.
Technical Support	•	•	•	NI provides access to support resources for your hardware.
Calibration Plan (Optional)		Standard	Expedited ³	NI performs the requested level of calibration at the specified calibration interval for the duration of the service program.

¹ This option is only available for PXI, CompactRIO, and CompactDAQ systems.

² This option is not available for all products in all countries. Contact your local NI sales engineer to confirm availability.

³ Expedited calibration is only available for the Traceable calibration level.

⁴ This applies to non-RF products only. Standard extended repair coverage for RF products is <15 working days + standard shipping.

PremiumPlus Service Program

NI can customize the offerings listed above or offer additional entitlements such as on-site calibration, custom sparring, and lifecycle services through a [PremiumPlus Service Program](#). Contact your NI sales representative to learn more.

Technical Support

NI hardware service programs and warranty include access to technical support provided by NI support agents during local business hours. Service requests can be managed online. Additionally, take advantage of NI's award-winning [online resources](#) and [communities](#).

©2023 National Instruments. All rights reserved. National Instruments, NI, and ni.com are trademarks of National Instruments. Other product and company names listed are trademarks or trade names of their respective companies. All rights reserved. National Instruments, NI, and ni.com are trademarks of National Instruments.



Mess- und Prüftechnik. Die Experten.

Ihr Ansprechpartner /
Your Partner:

dataTec AG

E-Mail: info@datatec.eu

>>> www.datatec.eu

