

# R&S® ZNB3000 VECTOR NETWORK ANALYZER

Fast forward to results

**dataTec**

Mess- und Prüftechnik. Die Experten.

**Ihr Ansprechpartner /  
Your Partner:**

**dataTec AG**

E-Mail: [info@datatec.eu](mailto:info@datatec.eu)

>>> [www.datatec.eu](http://www.datatec.eu)



Product Brochure  
Version 02.00

**ROHDE & SCHWARZ**

Make ideas real



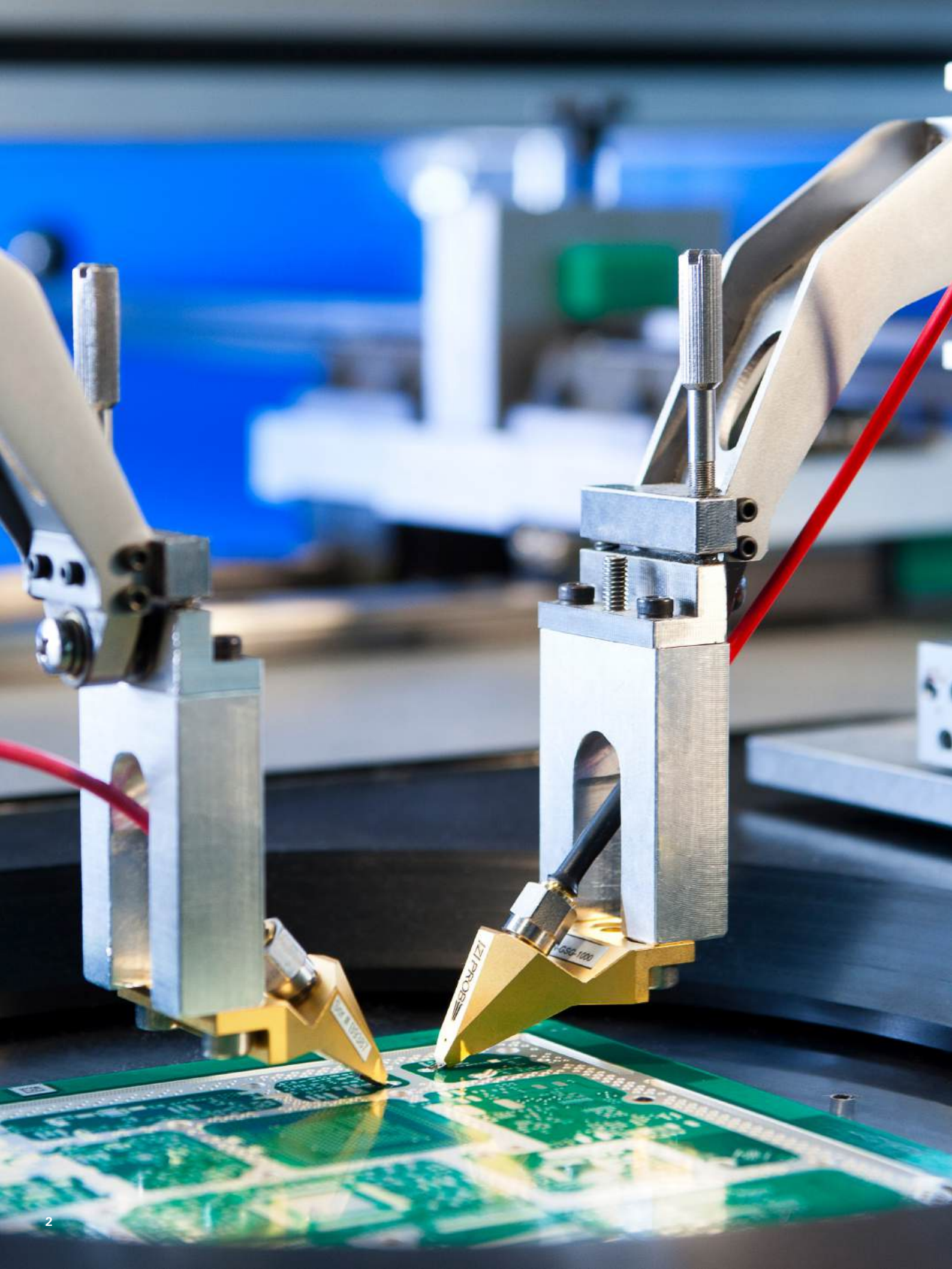



# CONTENTS

## Overview

### At a glance

▶ page 4

### Clearly structured user interface

▶ page 6

### Wide range of connectivity and extension options

▶ page 8

## Highlights

### Excellent RF performance

▶ page 10

### Intuitive GUI that speaks the user's language

▶ page 12

### At home in high-volume production

▶ page 14

### Calibration made easy

▶ page 16

### Embedding/deembedding for a diverse range of test fixtures

▶ page 18

### Real-time measurement uncertainty analysis

▶ page 20

## Applications

### Time domain analysis and signal integrity measurements

▶ page 22

### Fast EMC test site validation

▶ page 24

### Filter measurements

▶ page 25

### Measurements on up to 48 ports

▶ page 26

### Measurements on amplifiers and mixers

▶ page 28

### Tests in vacuum chambers and on multiport devices

▶ page 30

## Additional information

### Specifications in brief

▶ page 32

### Ordering information

▶ page 34



# AT A GLANCE

With more than 70 years of experience in the field of vector network analysis, Rohde & Schwarz sets new benchmarks with its R&S®ZNB3000 vector network analyzer family. These solid general purpose network analyzers combine high measurement speed and precision with exceptional RF performance and a wide range of options for challenging applications. This product brochure presents the R&S®ZNB3004 and R&S®ZNB3020, each as a 2 and a 4 port model.

With frequency ranges from 9 kHz to 4.5 GHz, 9 GHz, 20 GHz and 26.5 GHz, the R&S®ZNB3000 vector network analyzers are the instrument of choice for applications in the communications, electronic goods and aerospace industries as well as in the design of digital high-speed printed circuit boards and cables.

The R&S®ZNB3000 really shines and delivers the best results in environments where high-volume production and short ramp-up times are the norm. The R&S®ZNB3000 offers a flexible upgrade concept for rapid upscaling and to adapt to your requirements. With its high measurement speed and stability, outstanding RF performance and extended functionality, the R&S®ZNB3000 is the instrument that will get the job done.

The R&S®ZNB3000 combines high measurement accuracy with exceptional speed – better than 2.5  $\mu$ s per point. It features excellent temperature and long-term stability, allowing reliable measurements over several days without recalibration.

The R&S®ZNB3000 features a wide dynamic range of up to 150 dB (at 10 Hz IF bandwidth), low trace noise of less than 0.0003 dB RMS (10 kHz IF bandwidth) and high output power of up to +11 dBm at 26.5 GHz, which can be adjusted electronically in a range of 95 dB.

The short-depth, compact 2-port and 4-port models leave plenty of space on the workbench for measurement applications. They feature impressively low operating noise thanks to low power consumption and a sophisticated cooling concept. Low power consumption also reduces operating costs and protects the environment.

## KEY FACTS

- ▶ Frequency ranges from 9 kHz up to 26.5 GHz
- ▶ Fast sweep times, e.g. 11.8 ms for 1601 points, 1 MHz to 26.5 GHz, uncorrected, 500 kHz IFBW
- ▶ Wide dynamic range of up to 150 dB
- ▶ High output power, e.g. +11 dBm at 26.5 GHz
- ▶ Flexible frequency upgrade concept
- ▶ Extended embedding/deembedding capability
- ▶ Manual and automatic calibration
- ▶ 4-port models with two independent sources
- ▶ Expansion up to 48 ports using switch matrices
- ▶ Real-time analysis of measurement uncertainty



R&S®ZNB3000 models

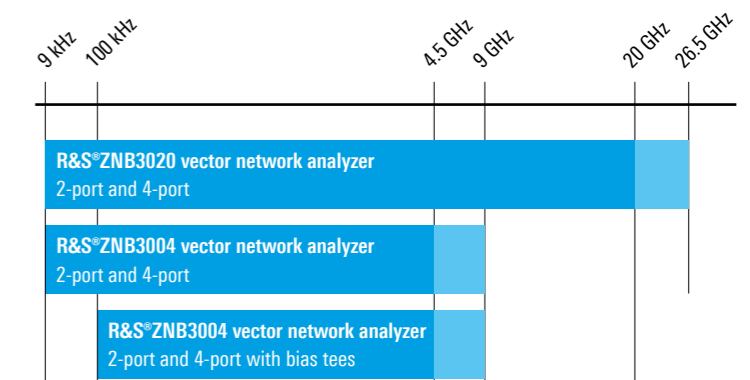

# CLEARLY STRUCTURED USER INTERFACE

## Toolbar

Direct access to frequently used functions, e.g. zoom, new trace, new marker, save, print

## Large multi-touchscreen color display (30 cm/12.1")

Clear display of a large number of traces

## Softkeys and soft panel

Optionally on the right or left side

## Help

Context-sensitive help

## Undo/Redo (softkeys)

Cancels or restores the last one-to-six entries

## Hardkeys

Fast access to important menus – even when wearing gloves

## Preloaded setups

Toggle between instrument setups by touching or clicking a tab

## Help and preset

- ▶ Help: context-sensitive help
- ▶ Preset: resets instrument to default state

## More than 100 channels and traces

Straightforward display of complex measurements

## Undo/Redo (hardkeys)

Cancels or restores the last one-to- six entries

## Pop-up menus

Fast access to desired function

## USB connectors for accessories

For connecting power sensor, calibration unit, keyboard/mouse, storage media, etc.

## Power on/off

LEDs indicate the operating state

## Transparent dialog windows

Traces remain visible

## Up to four ports with ample spacing

Easy connection of DUT; plenty of space for connecting test cables





# WIDE RANGE OF CONNECTIVITY AND EXTENSION OPTIONS

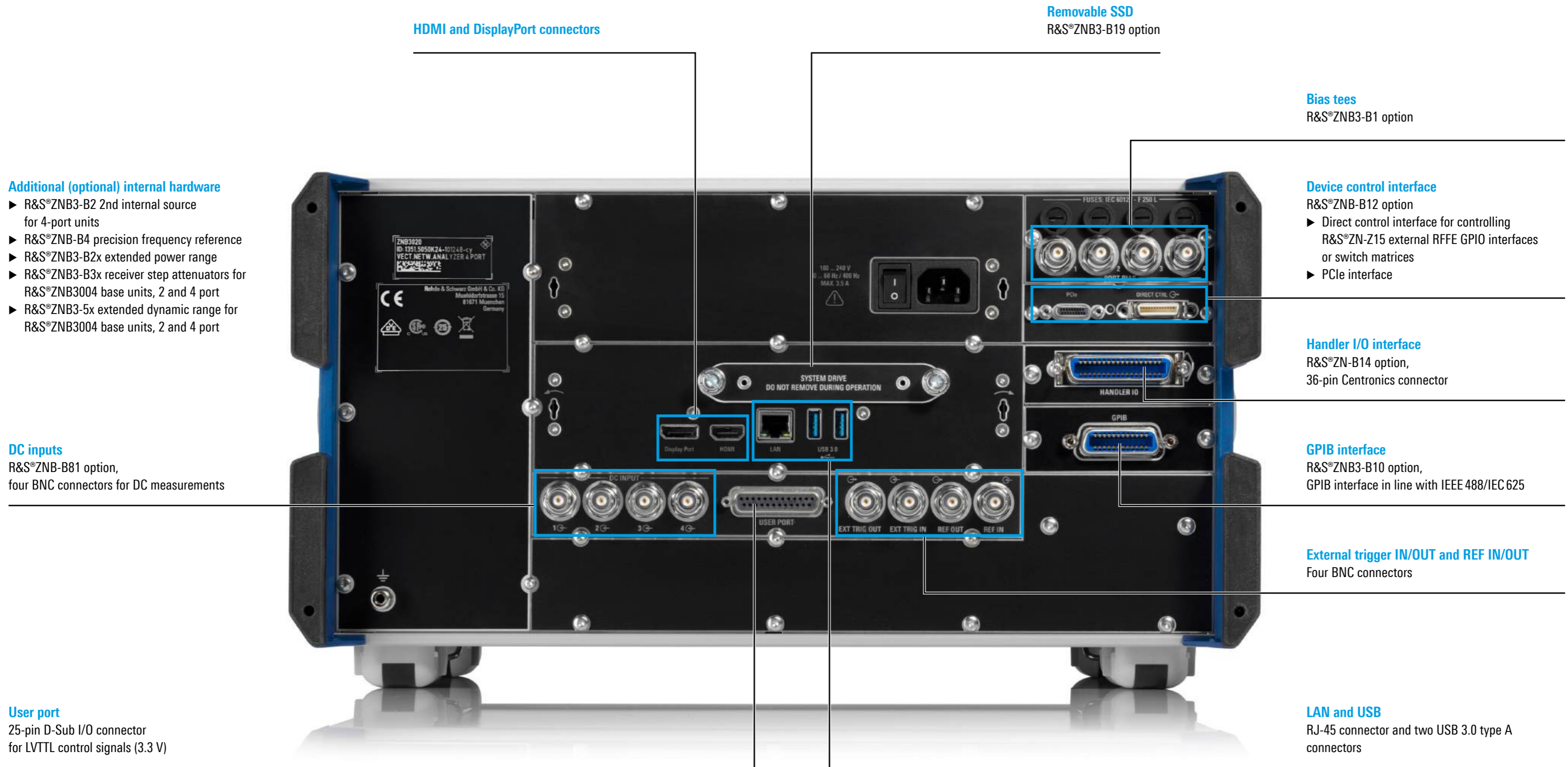

# EXCELLENT RF PERFORMANCE

The analyzers of the R&S®ZNB3000 family combine fast measurement speed, wide dynamic range and high temperature stability with excellent raw data to deliver performance and measurement throughput that meets even the greatest challenge in high-volume production applications. The R&S®ZNB3000 is especially well suited for development and large-scale production of RF components.

## Wide dynamic range

The R&S®ZNB3000 family introduces a unique receiver concept that, in combination with high sensitivity and low trace noise, extends the dynamic range of all 20 GHz and higher models. The R&S®ZNB3000 base units typically provide 150 dB dynamic range (at 10 Hz IF bandwidth), outperforming other comparable analyzers on the market.

The R&S®ZNB3-B52/B54 options extend the dynamic range of the R&S®ZNB3004 to as high as 150 dB.

Users benefit from the analyzer's wide dynamic range not only in selected frequency bands but right from the 9 kHz start frequency.

## High measurement speed

The R&S®ZNB3000 boasts fast DDS based synthesizers with switching times of below 2.5  $\mu$ s. In combination with high output power and excellent dynamic range, this provides maximum throughput for high-volume production tests and allows the analyzer to perform measurements faster than competitor instruments. In parallel measurement mode (4-port instruments only), two 2-port DUTs can be simultaneously tested. This further improves the production throughput capabilities of the R&S®ZNB3000.

## High temperature and long-term stability

The R&S®ZNB3000 test set and receivers feature excellent temperature and long-term stability. Magnitude and phase drift are very low, with typical values of less than 0.01 dB/°C and 0.15°/°C. A calibrated R&S®ZNB3000 allows precise measurements over several days without recalibration.

R&S®ZNB3000 dynamic range (at 1 Hz IF bandwidth)

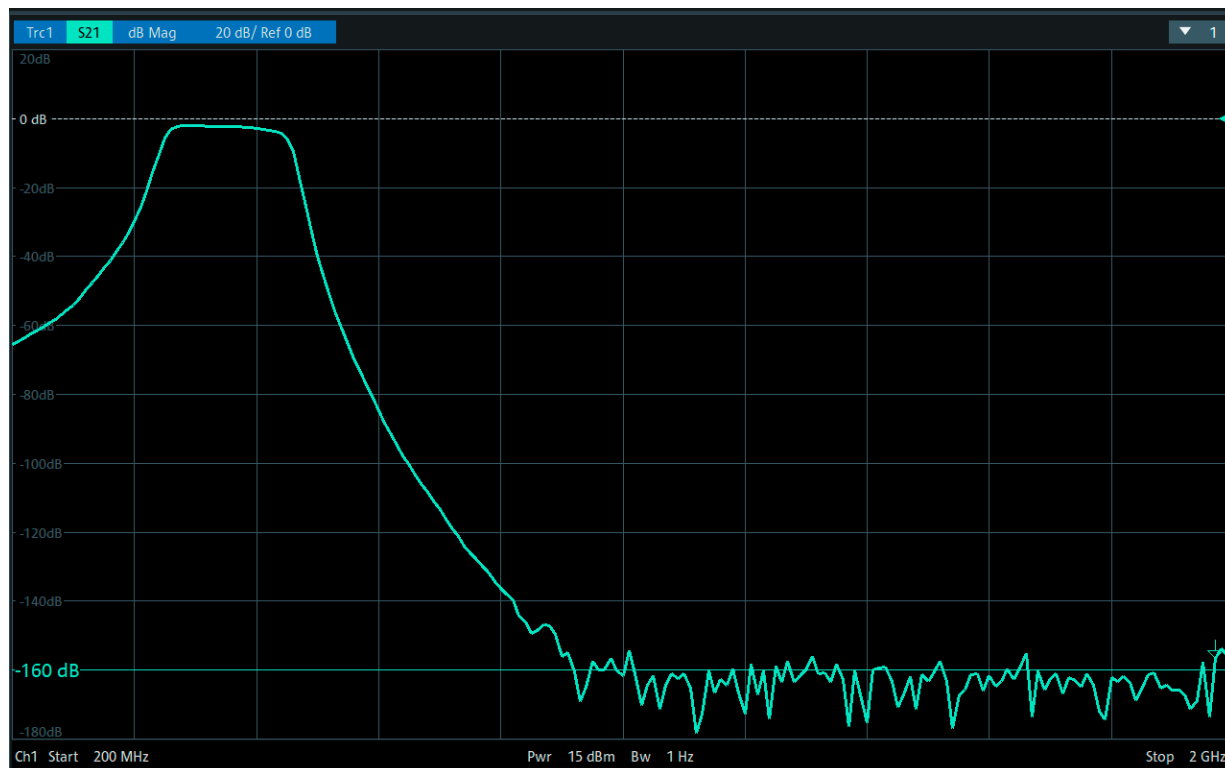

### Mixed-mode S-parameters for balanced DUT characterization

The instrument can characterize both single-ended and differential DUTs. To characterize a DUT with two balanced ports, the R&S®ZNB3000 treats the DUT like an unbalanced 4-port device. It calculates the 16 single-ended S-parameters and converts them to mixed-mode S-parameters. This additional computational effort does not compromise measurement speed. A wizard guides the user through the individual steps of the measurement – fast and straightforward.

### Integrated SCPI recorder

When it comes to programming, the R&S®ZNB3000 simplifies the task. The integrated SCPI recorder records each keystroke and creates a list of step-by-step commands even for the most complicated measurement setup. The recorded SCPI script can be directly copied into the user's code, or exported in the following formats: C, Python and MATLAB.

### Redefined S-parameters for flexible test setup configuration.

The R&S®ZNB3000 firmware allows redefining S-parameters to support external test setups, e.g. a high-power test set.

For this purpose, an external coupler decouples the reference signal and the signal reflected by the DUT. An example of this is given under "Redefined S-parameters" (lower diagram). The external coupler is connected to port 1 via the amplifier, and the reference and reflected signal are measured via ports 2 and 3. The S-parameters can be redefined accordingly.  $S_{11}$  can be calculated as the wave ratio  $b_3/b_2$  using the signal from port 1.

### Block diagram of an R&S®ZNB3000 4-port model with two internal sources

### Redefined S-parameters

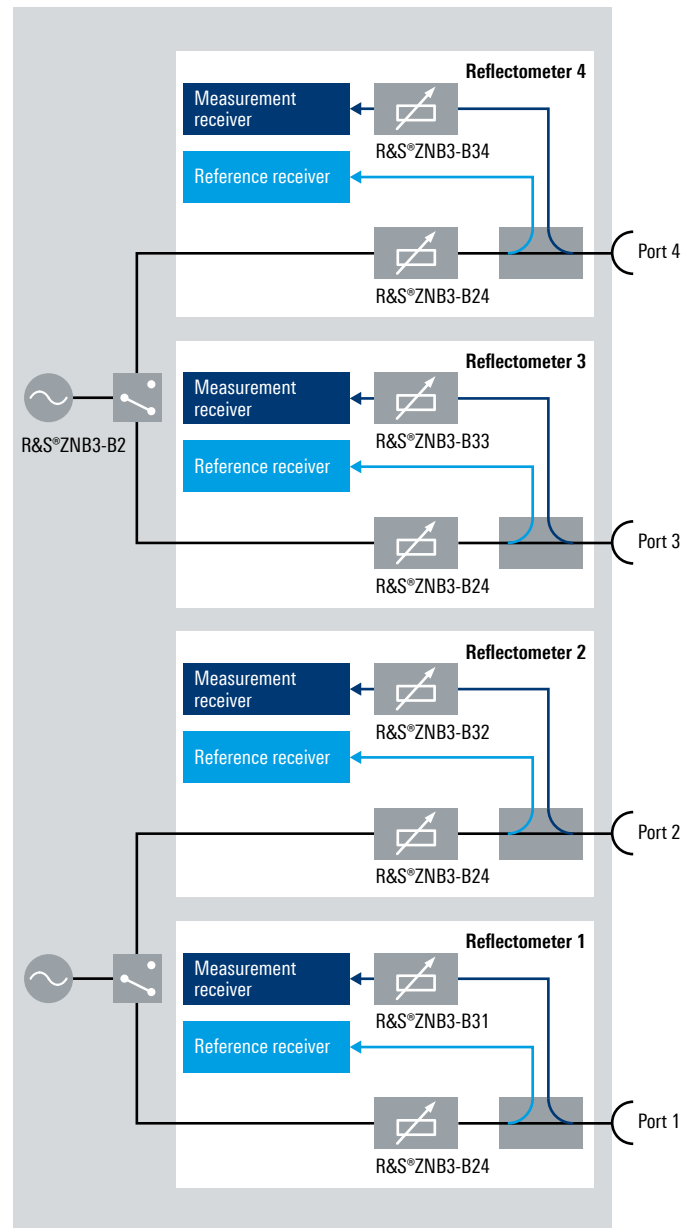
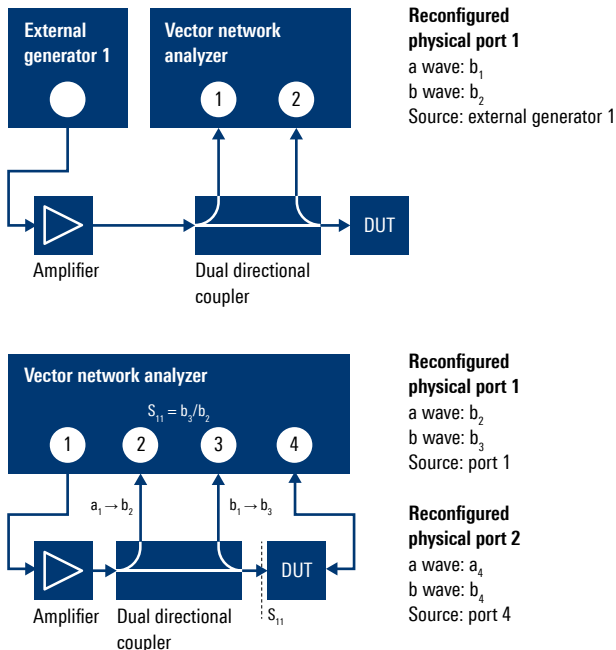



# INTUITIVE GUI THAT SPEAKS THE USER'S LANGUAGE

The R&S®ZNB3000 builds upon the proven R&S®ZNB GUI: configuration, measurement and analysis – fast and intuitive as never before.

## Simple and clear menu structures for efficient operation

The R&S®ZNB3000 groups together logically related control functions at a single operational level.

The **soft panel** shows all key functions and parameters that may be needed for a specific measurement and effectively helps users perform their tasks. Users can access all instrument functions in a maximum of three steps.

**Pop-up menus** allow many test parameters to be defined right where they are displayed.

**Wizards** guide the user through a sequence of steps – e.g. for configuring or calibrating an analyzer – reducing operator errors to a minimum.

## Efficient operation with multitouch gestures and flexible display configuration

Whether zooming, moving traces or adding markers: multitouch gestures make the R&S®ZNB3000 very efficient to operate. On its brilliant 12.1" WXGA color touchscreen, the user can customize the display by arranging diagrams, traces, channels and markers in whatever combination is desired. All of these elements can be dragged and dropped between diagrams or deleted to adapt the display to the measurement task at hand. The intuitive user interface on the R&S®ZNB3000 makes it is easy to get started and obtain quick results.

## Zoom function

Users can zoom in and out with a simple multitouch gesture.

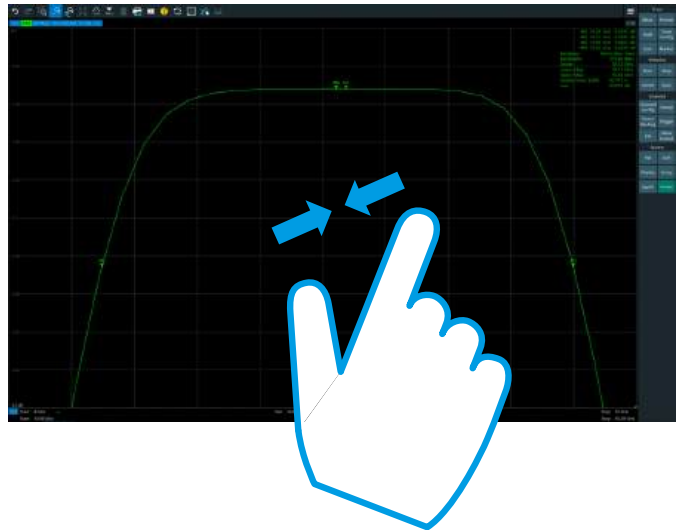
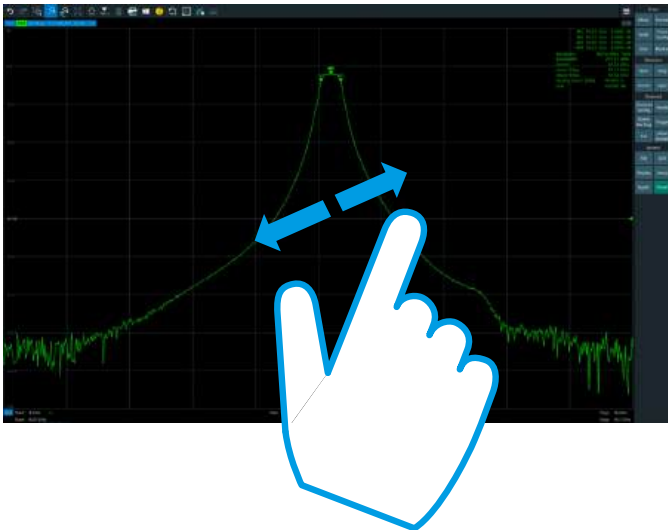

### Comprehensive trace analysis functions

A wide range of analysis functions helps users evaluate important parameters in a straightforward manner:

- ▶ Ten markers per trace, including analysis functions and conversion to the desired unit
- ▶ Automatic bandwidth measurements on filters
- ▶ Limit line and ripple check with configurable pass/fail indication
- ▶ Statistical trace analysis including maximum, minimum, RMS and peak-to-peak detection as well as compression point measurement
- ▶ Equation editor for complex trace mathematics

### Fast switching between instrument setups

Multiple setups are available simultaneously in the R&S®ZNB3000. This allows users to quickly switch between measurement tasks. This feature is especially helpful with DUTs that require different measurements. Users can maintain a better overview and control measurements more easily.

### An analyzer that speaks the user's language

Many tasks are easiest solved in the user's native language. With this in mind, the R&S®ZNB3000 comes with a multilingual user interface. Currently available languages include Chinese, English, French, Japanese, Russian and others. The R&S®ZNB3000 also lets users select the remote control command set. It supports the remote control command sets of practically all other Rohde&Schwarz network analyzers as well as those of other manufacturers' instruments. This makes it very easy to replace an obsolete analyzer with an R&S®ZNB3000 or integrate an R&S®ZNB3000 into an existing system.

### Several ways to arrive at the desired setup

#### Conventional approach

Users can take a conventional approach to configuring measurements on the R&S®ZNB3000. From various menus, they can select the parameters for a desired setup – e.g. power parameters, the number of points, the measurement type and measurement quantity. However, complex test setups – for mixer or intermodulation measurements, for instance – require careful setting of a vast number of parameters, a time-consuming and error-prone process. To enable users to configure even complex measurement tasks quickly and accurately, covering all the required parameters, the R&S®ZNB3000 offers two alternatives, with the wizard guided system or directly from the measurement menu.

#### All-in-one dialogs – keeping track even of sophisticated setups

All-in-one dialogs for typical measurements such as intermodulation on mixers combine in a single display all key parameters otherwise distributed among several menus. The hardware is configured interactively using graphic elements. Test parameters such as frequencies, power levels and bandwidths are set via pull-down menus and input fields. Users see all relevant information at a glance, not missing a single parameter. Measurement traces for any desired measurement quantities can then be dragged and dropped to any desired position.

# AT HOME IN HIGH-VOLUME PRODUCTION

The R&S®ZNB3000 is specially designed for high-volume production applications. It offers an optimum combination of speed, stability and performance.

## Maximized throughput

The combination of a fast DDS-based synthesizer, a wide dynamic range, extremely low trace noise and efficient backend data acquisition, processing and transfer results in extremely high measurement throughput. The R&S®ZNB3020 can perform a frequency sweep covering 1 MHz to 26.5 GHz, 1601 points, and 500 kHz IF bandwidth with full two port error correction in a total measurement time of 21.2 ms. This makes it the instrument of choice for high volume production, where minimizing cost of test per second and maximizing throughput are essential. In addition, the 4-port R&S®ZNB3000 can measure two 2-port devices in parallel, additionally improving device characterization throughput. The two independent generators can be offset in frequency to avoid cross-talk on wafer measurements, thus improving yield and accuracy.

The R&S®ZNB3000 vector network analyzers have exceptionally low trace noise. A typical value of 0.0008 dB RMS at 26.5 GHz means that wider IF bandwidths can be used without compromising accuracy. The benefit for production of RF components is even higher measurement throughput than what is normally possible with standard trace noise values.

Testing a frontend module with the R&S®ZNB3000, an R&S®ZN-Z84 switch matrix and an R&S®ZN-Z15 RFFE GPIO interface option (external box). The R&S®ZN-Z15 allows the module's MIPI RFFE interface to be directly addressed by the R&S®ZNB3000 firmware. The R&S®ZRun VNA test automation suite can be used to increase measurement throughput.

## Ideal choice for filter characterization

Measurement speed for tests on high-rejection DUTs, such as base station duplex filters, is determined not only by the synthesizer settling times but also by the required dynamic range and the corresponding IF bandwidth. The R&S®ZNB3000 offers a dynamic range of up to 150 dB for a 10 Hz IF bandwidth. This means that for a measurement requiring 110 dB dynamic range, the R&S®ZNB3020 can perform the task 1000 times faster by using a wider IFBW, which further improves measurement throughput and minimizes the cost of test.

## Fast production scale-up

Additional frequency ranges and an easy frequency upgrade concept assure rapid scale-ups of production and protect the investment for the long run. Regardless of test requirements, bare die, packaged or connectorized, the R&S®ZNB3000 is the preferred instrument by RF component manufacturers world wide.

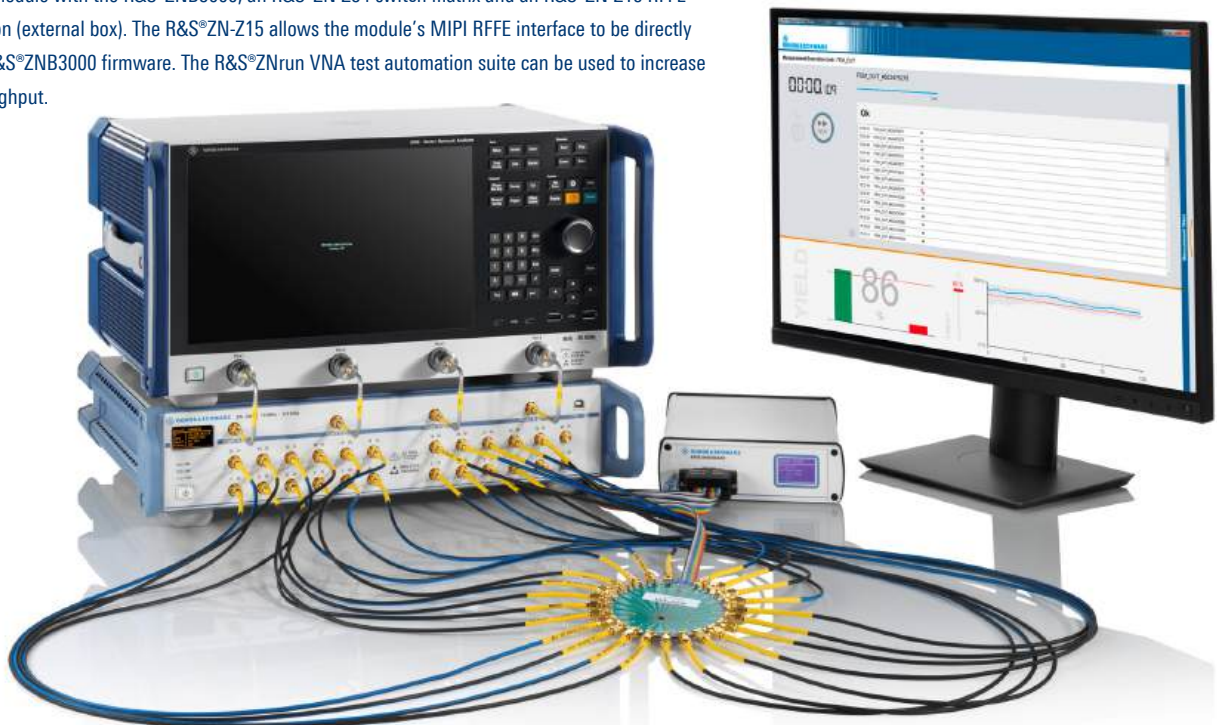



### Benefits of the R&S®ZNB3000

- ▶ Maximized throughput
- ▶ Extremely high measurement speed – 2.5 µs per point
- ▶ Wide dynamic range – up to 150 dB at 10 Hz IF bandwidth
- ▶ Optimized data acquisition, processing and transfer
- ▶ Extremely low trace noise – typical values 0.0005 dB RMS magnitude and 0.002° RMS phase at 10 kHz IF bandwidth
- ▶ Unrivaled RF performance e.g. wide frequency range, output power, trace noise, stability, extended functionality (noise figure, 2D gain compression measurements).
- ▶ Fast production scale-up – flexible upgrade concept
- ▶ Production test automation with R&S®ZNRUN
- ▶ Health and utilization monitoring service
- ▶ RFFE GPIO interface for direct module control
- ▶ Handler I/O interface

### Production test automation with R&S®ZNRUN software

The R&S®ZNRUN vector network analyzer test automation suite ideally complements the R&S®ZNB3000 in production applications. The software allows fast and easy execution and scaling of test sequences in production. The programmable plug-in interface can be used to integrate and control DUTs and external test equipment (e.g. parts handlers or barcode scanners).

R&S®ZNRUN is easy to adapt to special requirements and can be integrated into existing test sequences. It is ideal for use in high-speed, high-volume production of RF components.

R&S®ZNRUN configurations are modular and reusable, which helps minimize reconfiguration time when they are modified. Based on the configuration, R&S®ZNRUN calculates a connection plan optimized for speed.



R&S®ZNRUN also calculates an initialization sequence, a calibration plan and a speed-optimized test plan.

### Eliminate surprises with the health and utilization monitoring service (HUMS)

The health and utilization monitoring service (HUMS) software option is available for the R&S®ZNB3000 to improve monitoring of instrument utilization, status and health. Along with this data, the HUMS option provides other information – about the operating system and security patches installed on the R&S®ZNB3000, for instance. The HUMS option can be used on production lines to optimize overall utilization and minimize downtime.

### Convenient RFFE module tests with direct control via RFFE GPIO interface

A growing number of components such as filters, switches and amplifiers need to be integrated into the frontend modules of mobile devices such as smartphones and tablets and need to communicate with each other.

The RFFE bus defined by the MIPI Alliance has established itself as the de facto standard for achieving this. The optional R&S®ZN-Z15 RFFE GPIO interface (external box) allows the R&S®ZNB3000 to directly control RF frontend modules in mobile devices to perform measurements with modules set to various operating modes. The R&S®ZN-Z15 interface can also be used to perform current and voltage measurements on the DUT.

### Handler I/O interface for communications with external parts handlers

The optional R&S®ZN-B14 handler I/O interface enables communication between the R&S®ZNB3000 and an external parts handler. During a typical test cycle, a parts handler places the DUT into a holder and sends the start signal for the measurement. On completion of the measurement, the parts handler removes the DUT from the holder and sorts it according to predefined criteria. Then the handler places a new DUT in the holder, and the test cycle starts again. The R&S®ZNB3000 can thus be used for fast and reliable execution of automated tests, which play a key role in production applications.

Easy configuration of an antenna switching module using the external R&S®ZN-Z15 RFFE GPIO interface and the RFFE configuration menu.

# CALIBRATION MADE EASY

Along with classic through-open-short-match (TOSM) calibration for coaxial applications, the R&S®ZNB3000 also supports various calibration methods for on-wafer applications and waveguide measurements.

## Full calibration with only three standards – faster, simpler, more accurate

- ▶ Through-reflect-line/line-reflect-line (TRL/LRL) for on-wafer applications, waveguides and coaxial DUTs
- ▶ Through-reflect-match (TRM) for applications in test fixtures, on wafers and in waveguide environments
- ▶ Through-short-match (TSM) and through-open-match (TOM) as alternatives to TOSM for reduced calibration effort, providing the same accuracy

## Calibration for DUTs using a mix of connectors

The classic TOSM method does not support direct calibration of test setups for DUTs equipped with different types of connectors at the input and output. The R&S®ZNB3000 offers two alternatives to provide the desired calibration: the unknown-through-open-short-match (UOSM) method and the adapter-removal method.

**UOSM calibration** is the smartest way to overcome the above problem. A through connection with unknown parameters is required, such as a reciprocal (but otherwise more or less arbitrary) 2-port device like a simple, like cost-effective adapter. The effort is equivalent to that of the TOSM method.

As an alternative, the R&S®ZNB3000 offers classic **adapter removal calibration**. This method is very robust but involves considerably more calibration steps.

Selection of calibration methods on the R&S®ZNB3000.

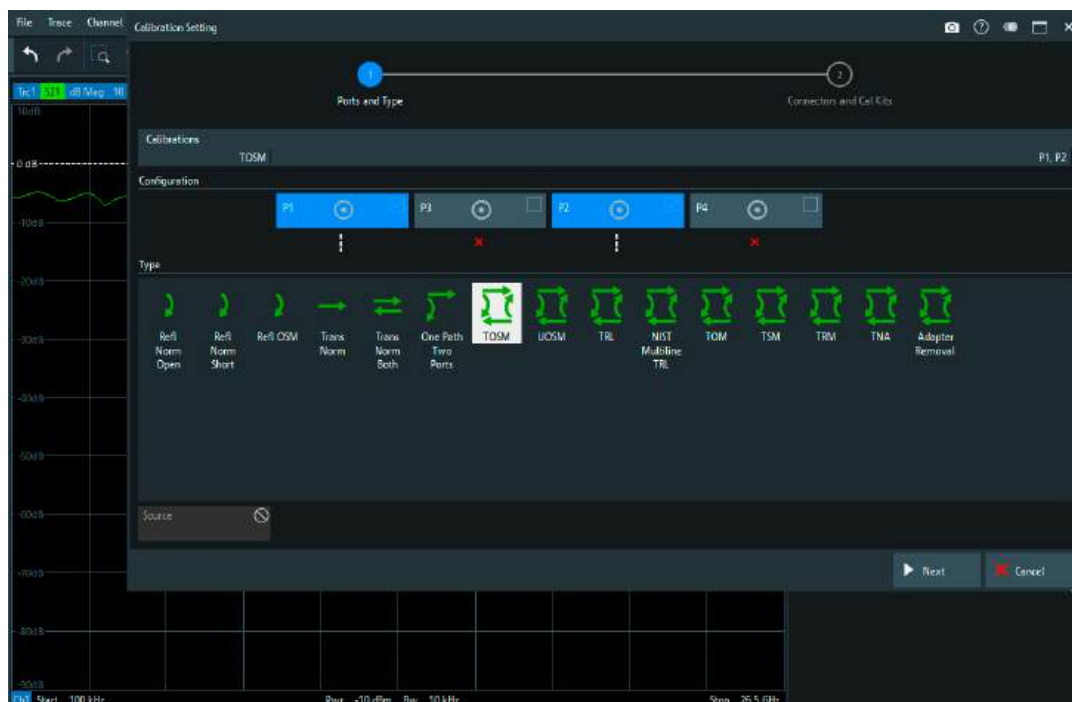



R&S®ZN-Z1xx  
economy calibration kits



R&S®ZV-Z210 and R&S®ZV-WR10  
high-end calibration kits



R&S®ZV-Z2xx and R&S®ZN-Z2xx  
high-end calibration kits

### Calibration equipment

The **economy calibration kits** of the R&S®ZN-Z1xx series provide robust operation up to 40 GHz.

The **high-end calibration kits** of the R&S®ZV-Z2xx and R&S®ZN-Z2xx series include calibration standards from type N through 1.0 mm (110 GHz). These kits achieve very high calibration accuracy thanks to precision manufacturing combined with S-parameter based characterization of the individual calibration standards.

**Automatic calibration units** up to 67 GHz with two or four ports greatly simplify calibration, while reducing operator errors and improving calibration repeatability.

### Inline calibration units

The R&S®ZN-Z32 and R&S®ZN-Z33 inline calibration units support applications such as precise and dependable testing of satellite components in thermal vacuum chambers (TVAC) and testing of multiport components on production lines. The R&S®ZN-Z32 inline calibration unit covers the frequency range from 10 MHz to 8.5 GHz and can be used at temperatures from +5°C to +40°C. The R&S®ZN-Z33 inline calibration unit comes in two models, both covering the frequency range from 10 MHz to 40 GHz. One model operates at temperatures from +5°C to +40°C; the second model (TVAC model) can withstand temperatures from -30°C to +80°C. The inline calibration units are controlled over the CAN bus by the R&S®ZN-Z30 inline calibration unit controller, which supports up to 48 units.



R&S®ZN-Z52  
automatic calibration unit



R&S®ZN-Z32  
inline calibration unit



R&S®ZN-Z33  
inline calibration unit



# EMBEDDING/DEEMBEDDING FOR A DIVERSE RANGE OF TEST FIXTURES

The R&S®ZNB3000 supports various embedding/deembedding techniques that can be used to remove the effects of different test fixtures and precisely characterize the DUT.

## Embedding and deembedding known networks

On the R&S®ZNB3000, it is possible to add virtual matching networks or remove existing, known networks. Touchstone .s2p, .s4p, .s6p and .s8p files can be used for single-ended configurations, differential configurations and multiport DUTs to remove test fixtures (deembedding) or to virtually install the DUT into a matching network (embedding).

Alternatively, the R&S®ZNB3000 offers a choice of pre-defined, configurable 2-port and multiport matching networks that can be applied to characterize the DUT matched to the impedance of its targeted operating environment.

Workflow support: extremely easy operation with integrated user guidance

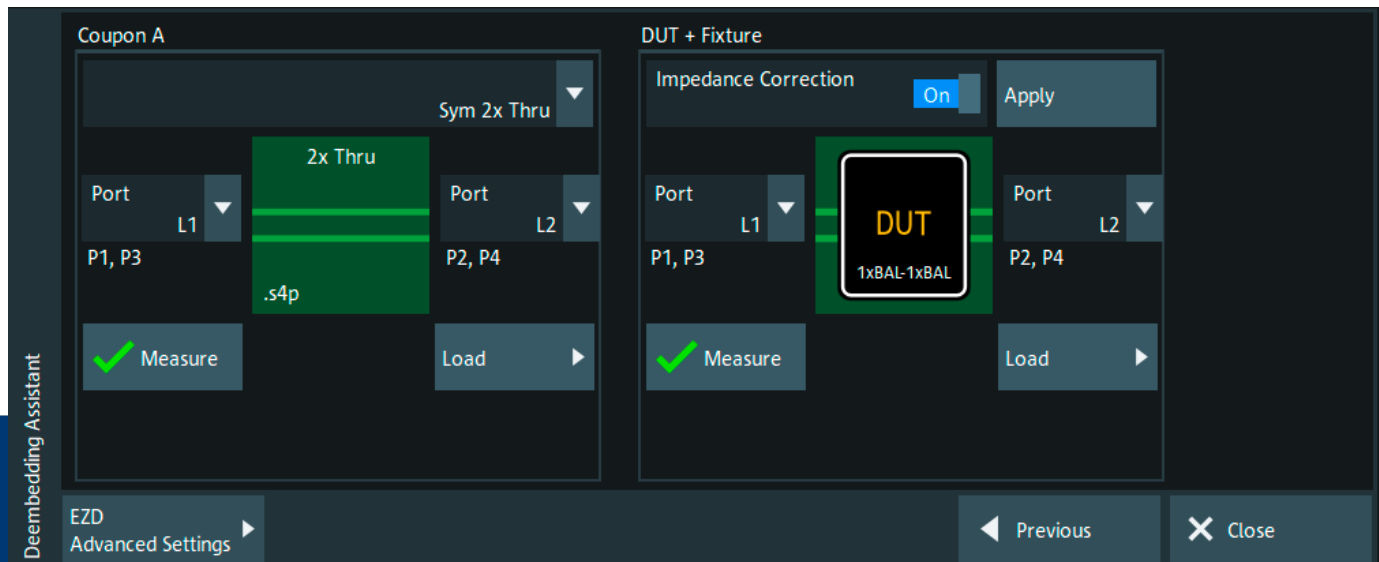

## Deembedding test fixtures with the R&S®ZNB3000

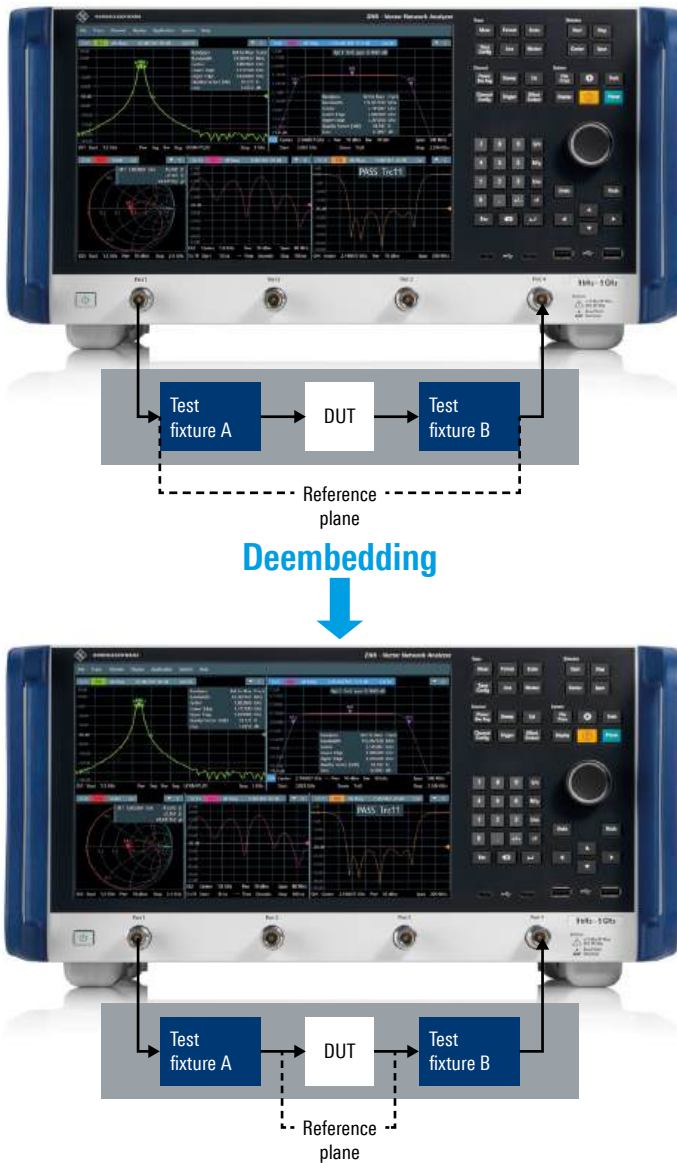

## High-quality deembedding using efficient software algorithms

Devices that do not have coaxial connectors can be installed in test fixtures to create a coaxial environment. To remove the effects of test fixtures with unknown S-parameters, the R&S®ZNB3000 provides various optional enhanced deembedding procedures. They make it possible to characterize the test fixture, extract the S-parameters and conveniently deembed the test fixture.

The deembedding algorithms supported by the R&S®ZNB3000 are industry-recognized techniques in line with IEEE P370. They include in-situ deembedding (ISD, R&S®ZNB-K220), smart fixture deembedding (SFD, R&S®ZNB-K230) and EaZy deembedding (EZD, R&S®ZNB-K210).

The easy-to-use deembedding options are fully integrated into the R&S®ZNB3000 user interface. The software guides the user quickly and effectively through the required measurement steps. The S-parameters extracted from test fixtures for the purpose of deembedding need not be exported or imported – a major advantage of this integrated solution.

### Advantages

- ▶ Easy, test-fixture-corrected DUT characterization, even when non-coaxial connections are used for testing
- ▶ Accurate test fixture deembedding, handling different impedance planes
- ▶ Suitable for high frequencies
- ▶ S-parameter extraction from test fixtures
- ▶ Easy operation due to integrated user guidance

# REAL-TIME MEASUREMENT UNCERTAINTY ANALYSIS

The R&S®ZNB3000 is a very precise instrument that can be used in microwave labs as well as on production lines. For both types of applications, knowing the actual uncertainty under given test conditions is crucial. The R&S®ZNB3-K50(P) measurement uncertainty analysis option provides a real-time display of the measurement uncertainty along with a traceable uncertainty calculation.

Until now, calculating measurement uncertainty for a DUT's S-parameter results was possible only in a metrology lab. But now, thanks to the R&S®ZNB3-K50(P) option, the R&S®ZNB3000 can perform this calculation on its own. R&S®ZNB3-K50(P) was developed in cooperation with METAS, the Swiss Federal Institute of Metrology. The option automatically calculates measurement uncertainty bands and displays them along with measured S-parameters. This allows users to keep track of measurement uncertainty at a glance.

The R&S®ZNB3-K50(P) option can also be used to perform verification tests. In this case, the characterization data for the verification kit is compared to the results measured by the R&S®ZNB3000 for the verification kit.

In combination with the METAS VNA Tools software installed on the R&S®ZNB3000, this verification test is just as easy as calibration. After selecting the desired verification kit, the user is guided by the R&S®ZNB3000 through the verification test. The procedure includes the creation of a test archive that contains an uncertainty database for the test setup along with raw measurement results and calibrated measurement results.

Verification kits are needed in order to evaluate the uncertainty of measurement results. Rohde&Schwarz offers verification kits up to 50 GHz (e.g. the R&S®ZV-Z435, a 3.5 mm verification kit up to 26.5 GHz). These kits contain verification standards that are accredited by Germany's national accreditation body (DAkkS).



Real-time S-parameter measurements with uncertainty bands



Verification standards in the R&S®ZV-Z435 3.5 mm verification kit



# APPLICATIONS

The R&S®ZNB3000 supports a wide range of applications. The time domain option makes it possible to perform signal integrity measurements or validate EMC test sites. Measurements on active and passive components can be efficiently set up via intuitive configuration menus and with the use of wizards. The R&S®ZNB3000 in combination with R&S®ZN-Z8x switch matrices delivers multiport measurements on up to 48 ports.



# TIME DOMAIN ANALYSIS AND SIGNAL INTEGRITY MEASUREMENTS

The R&S®ZNB3000 provides powerful time domain analysis.

## Efficient time domain analysis with enhanced resolution

The R&S®ZNB3000 supports powerful time domain analysis on components such as test fixtures, cables and connectors. With up to 100 000 test points per trace, even electrically long DUTs such as cables can easily be tested. They can be analyzed by displaying the impedance versus length. The gating function allows the R&S®ZNB3000 to isolate or mask discontinuities.

A 4-port R&S®ZNB3000 can be used to measure the balanced S-parameters and other parameters such as near-end and far-end crosstalk (NEXT, FEXT) on two-wire lines and differential structures.

Using prediction, the frequency range of the R&S®ZNB3000 can be virtually extended. This yields temporal and spatial resolution substantially higher than would be expected from the DUT's or analyzer's frequency range.

## Generation of eye diagrams

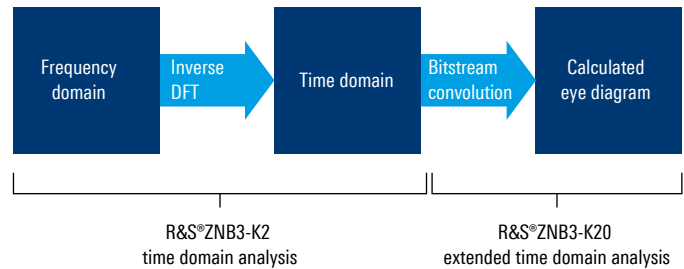

## Signal integrity at a glance with eye diagrams

The R&S®ZNB3000 provides comprehensive analysis of cables and connectors in the time and frequency domains. The R&S®ZNB3-K20 extended time domain analysis option makes it possible, based on the S-parameters, to calculate and display the rise time, skew and eye diagrams for different bit patterns, revealing transmission quality at a glance. The R&S®ZNB3-K2 time domain analysis and the R&S®ZNB3-K20 extended time domain analysis options are integrated in the analyzer firmware. Eye diagrams and S-parameters versus frequency and time can be analyzed and displayed simultaneously.

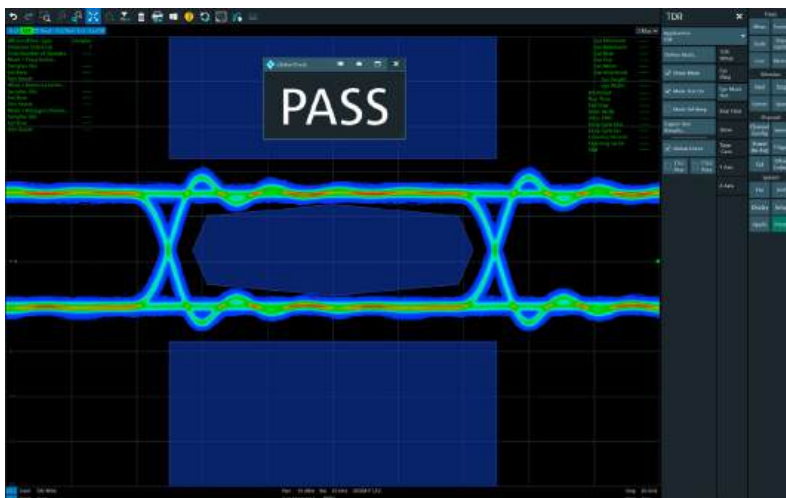

Eye diagram with limit mask and pass/fail evaluation.

### Analysis of disturbance effects and signal quality optimization

The R&S®ZNB3-K20 extended time domain analysis option makes it possible to simulate the effects of disturbances such as jitter and noise on the eye diagram. The analyzer can also simulate the impact of correction algorithms such as preemphasis at the transmitter end and equalization at the receiver end. User-defined mask tests can also be configured.

### Distance-to-fault measurements

The R&S®ZNB3-K3 distance-to-fault option can be used to locate discontinuities in cables. Discontinuities cause peaks in the impulse response, which are easy to display and analyze using the R&S®ZNB3-K3 option. The option comes with a choice of predefined cable types with their typical properties.

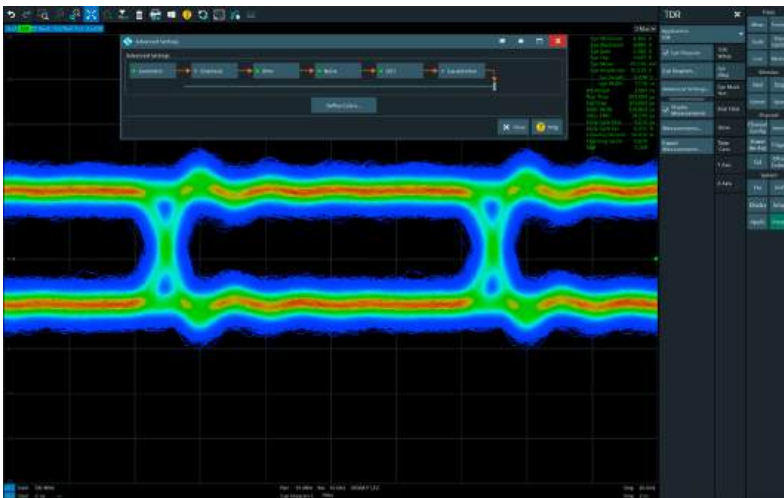

Simulation of the effects of various disturbances such as jitter and noise on the eye diagram.

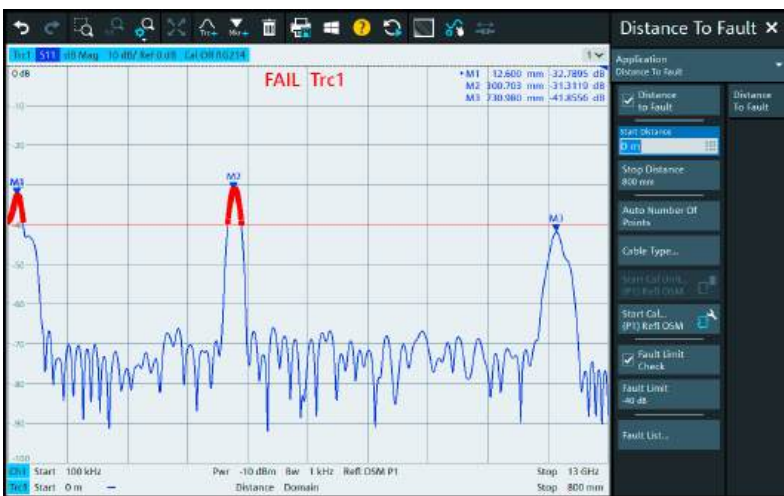

Reflections on a cable terminated with 40 dB. Marker M3 indicates the total cable length (73 cm). Marker M2 shows the distance to the fault (30 cm). Marker M1 represents the impedance matching of the connector.

# FAST EMC TEST SITE VALIDATION

Fully anechoic rooms (FAR) intended for EMC compliance measurements that rely on free space conditions need to be validated in order to verify that the acceptance criterion for these measurements is met. The R&S®ZNB3000 with time domain analysis capability solves this task fast and with high precision.

## TD $S_{VSWR}$ calculation

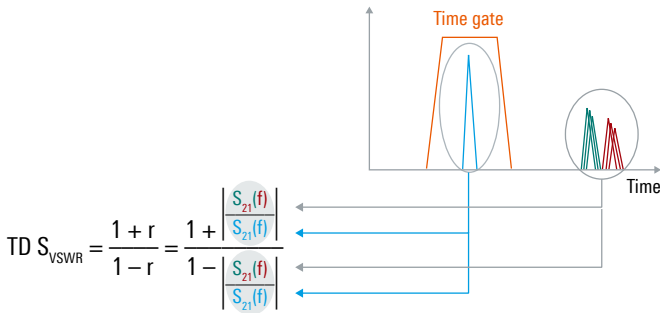

## TD $S_{VSWR}$ measurements with a vector network analyzer

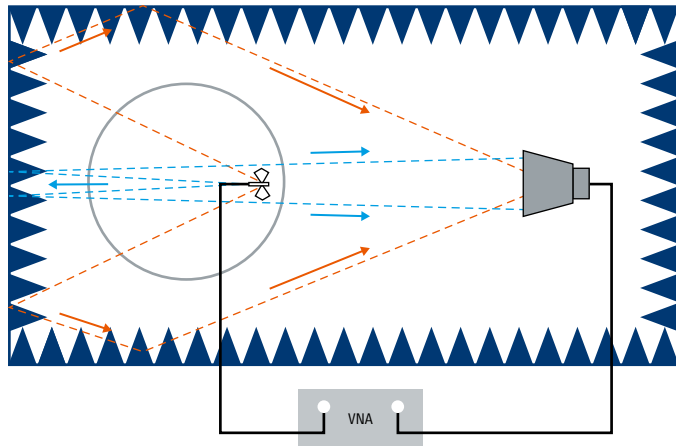

The time domain site VSWR (TD  $S_{VSWR}$ ) measurement in line with ANSI C63.25 is a fast and precise method for validating fully anechoic rooms (FAR). It involves a series of impulse response measurements, which are performed by a 2-port R&S®ZNB3004 equipped with the R&S®ZNB3-K2 option, plus an R&S®HF907 double-ridged waveguide horn antenna. R&S®ZRun software can be used to automate the test sequence.

In addition to demonstrating compliance with the site VSWR requirements, the TD  $S_{VSWR}$  method provides other valuable information. For example, the impulse response results displayed in the time domain analysis view can be used to identify areas in a FAR where additional or better quality absorbers are needed.

The antenna impulse response in ideal free space would consist of a single pulse (direct antenna-to-antenna impulse response). However, since measurements are normally made in a test chamber and not in ideal free space, the TD  $S_{VSWR}$  method can also be used to identify undesired reflections in the chamber. These reflections can be separated from the direct antenna impulse response using time gating in order to calculate the TD  $S_{VSWR}$ .



# FILTER MEASUREMENTS

The R&S®ZNB3000 has many characteristics that are useful when testing filters. These include a wide dynamic range, fast measurement speed and diverse analysis capabilities.

## Segmented sweep tailored to the device under test

Testing high-rejection DUTs such as duplex filters for repeaters requires large IF bandwidths in the passband to ensure short measurement times. In the stopband, however, high output power levels and narrow IF bandwidths are needed to provide the required dynamic range. The analyzer's segmented sweep function divides the frequency axis into segments. The output power, IF bandwidth and number of test points can be separately defined for each segment to optimally match the sweep to the DUT characteristics. This increases measurement speed without any loss in accuracy.

## Investigating bandpass filters

Markers can be used to display the key parameters for a bandpass filter. In the marker menu, the R&S®ZNB3000 offers various options to define the reference marker for filter analysis. Once this marker has been set, the analyzer displays the key parameter values, e.g. for the bandwidth and center frequency.

## Filter tuning and fast pass/fail analysis

It is often necessary to test filters for compliance with limit values and tune the filters as required. The R&S®ZNB3000 has various support functions that quickly reveal whether a filter is within tolerance limits after tuning. For example, limit lines can be inserted and limit checks applied for a fast and clear indication of whether a DUT satisfies requirements.



Characterization of a bandpass filter.  
The values for the key parameters are displayed.



Ripple test in the passband of a bandpass filter with limit lines and pass/fail indications.

# MEASUREMENTS ON UP TO 48 PORTS

The R&S®ZNB3000 in combination with various switch matrices provides a comprehensive solution for complex measurements on modules with up to 48 ports.

## Expanding the number of ports with switch matrices

Components used in modern communications equipment, e.g. frontend modules in smartphones and tablets, support a growing number of frequency bands as well as other functions such as WLAN, Bluetooth®, GPS and mobile communications. As a result, the number of RF ports on

these modules is also growing, not least due to the use of differential components. The R&S®ZNB3000 in combination with various switch matrices provides a comprehensive solution for complex measurements on modules with up to 48 ports. Rohde&Schwarz matrices support full crossbar measurements, allowing all S-parameters of a multiport DUT to be determined.

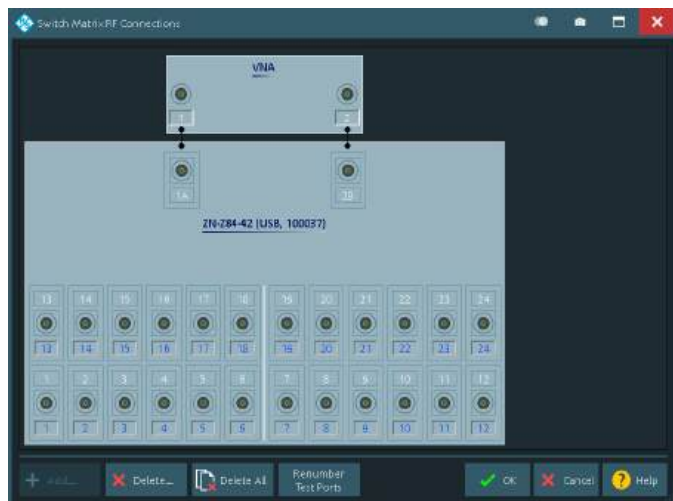

Automatic allocation of ports in the R&S®ZNB3000

## Easy configuration at the push of a button

The R&S®ZNB3000 controls the switch matrices via LAN, USB or a dedicated digital device control interface (R&S®ZNB-B12 option). With an R&S®ZNB3000 4-port model, for example, two switch matrices with two input ports and 24 output ports each can be combined to characterize DUTs with up to 48 ports. Once a matrix is connected, the analyzer automatically detects the matrix type and allocates the ports so that users can immediately start measuring. S-parameters, waves and wave ratios are directly selected and displayed on the R&S®ZNB3000 user interface.



R&S®ZNB3020 with two R&S®ZN-Z86 matrices

## Mixed configuration with matrix and standard VNA ports

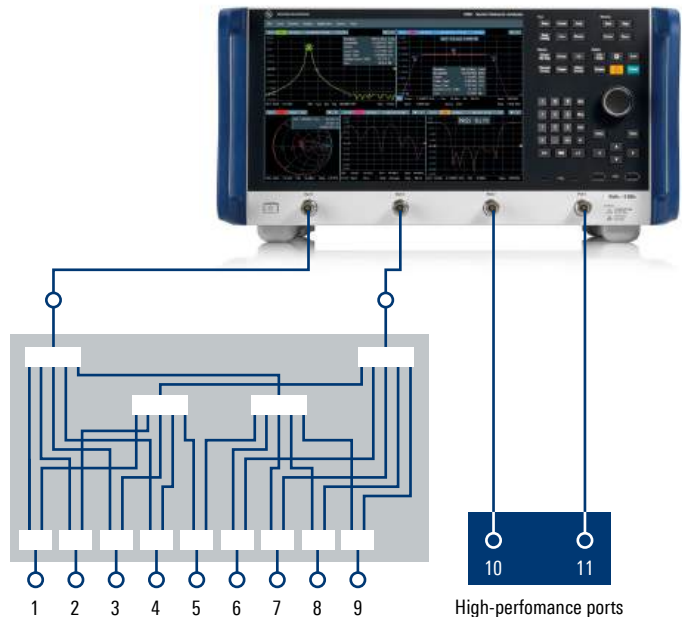

### Fast measurements and excellent RF characteristics

Switch matrices from Rohde & Schwarz feature exceptionally short switching times. The internal test sequences of the R&S®ZNB3000 control the matrix switches directly and synchronously with a dedicated device control interface (R&S®ZNB-B12 option). This speeds up measurements, especially for sweeps covering a small number of points.

Featuring a compact design and state-of-the-art electronic switches, the R&S®ZN-Z84 switch matrices exhibit low insertion loss. Other highlights include good test port matching and a high compression point, allowing measurements on active DUTs with output power levels up to +20 dBm.

Rohde & Schwarz offers calibration units with up to 24 ports (e.g. R&S®ZN-Z154). These enable fast, automated calibration of the R&S®ZNB3000 together with the matrices connected to it.

### Matrix solutions for every application

Rohde & Schwarz offers switch matrices for a variety of applications. Matrix models with two or four inputs and up to 24 outputs are available, allowing users to strike the optimal balance between low insertion loss, maximum accuracy and a large number of ports. The R&S®ZN-Z84 base units each come with six outputs. The R&S®ZN-Z84 switch matrix can be expanded to offer up to 24 outputs by adding further ports in groups of six. The R&S®ZN-Z84 covers the frequency range from 10 MHz to 8.5 GHz.

It is also possible to combine a 4-port R&S®ZNB3000 with a matrix with two inputs (mixed configuration). The remaining two ports can be used as standard VNA ports offering the outstanding performance the R&S®ZNB3000 is known for.

### R&S®ZN-Z84 or R&S®ZN-Z85 with 12 outputs for 4-port R&S®ZNB3000

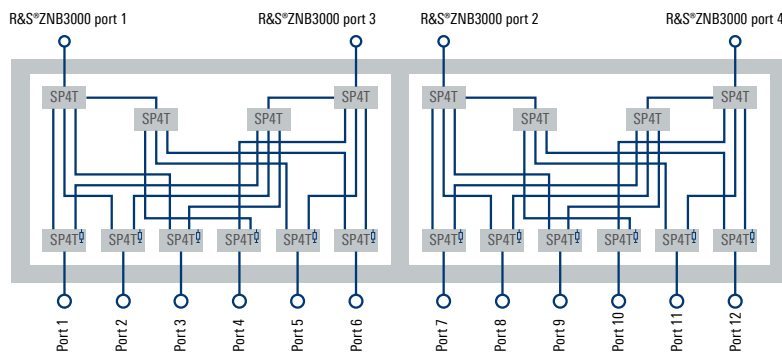

R&S®ZN-Z154 24-port calibration unit

### R&S®ZN-Z84 with 24 outputs for 2-port R&S®ZNB3000

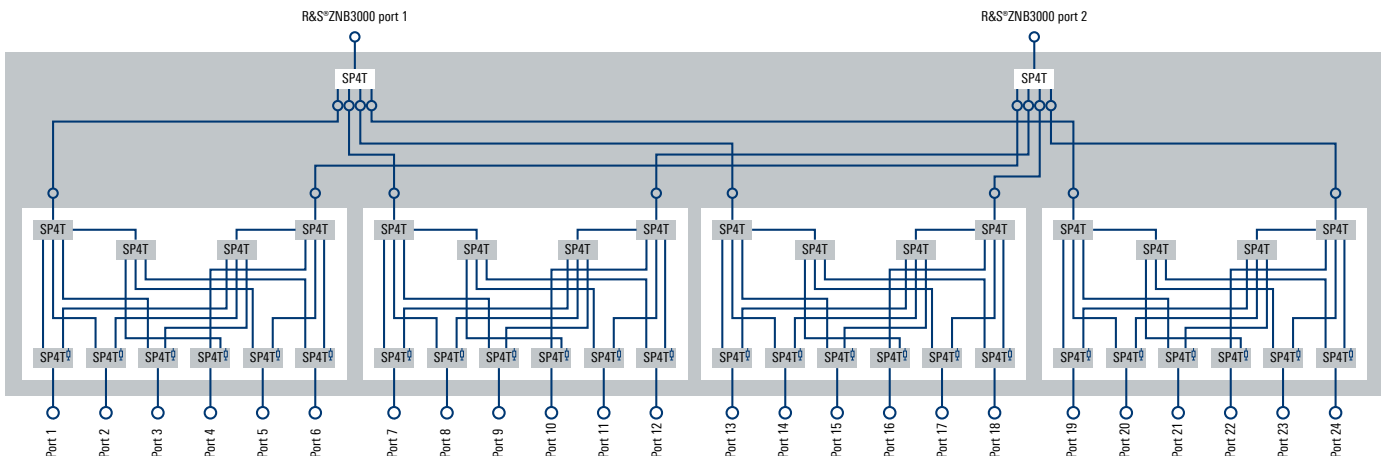

# MEASUREMENTS ON AMPLIFIERS AND MIXERS

The R&S®ZNB3000 is well suited to testing passive, active and frequency-converting components. It offers a variety of functions for these measurements, including a second internal source, a wide power sweep range and intuitive measurement configuration.

## Wide dynamic range for challenging intermodulation measurements

The R&S®ZNB3000 offers major benefits, especially for testing amplifiers with very small intermodulation products. Its wide dynamic range and the excellent power handling capacity of its receivers make it possible to measure low intermodulation distortion within seconds instead of minutes.

## Wizard-assisted measurement configuration

The R&S®ZNB3000 supports users in various ways during measurement configuration. Tools such as an intermodulation wizard and a mixer wizard help quickly configure the instrument setup for the intended measurements. A DUT-centric wizard is also available. It guides the user step by step to the desired setup, based on the type of DUT to be characterized.

## R&S®SMARTerCal – get ready for active device testing

Calibrating the absolute power levels of a network analyzer's sources and receivers is indispensable to reliably test amplifiers, mixers and T/R modules but is a time-consuming process. The R&S®ZNB3000 offers a special calibration technique referred to as R&S®SMARTerCal, which radically simplifies calibration. R&S®SMARTerCal combines the information gained from system error correction (e.g. TOSM, UOSM) with the information obtained through absolute power level calibration (wave quantities in terms of amplitude and phase). This means that the absolute power levels of the sources and receivers are already calibrated during system error correction, taking into account port mismatch.

For absolute output power level calibration, a power sensor needs to be connected to just one test port only once. The calibration values for all other sources and receivers are derived from the calibration values for that specific test port. This significantly reduces calibration time and effort.

Wizard-assisted configuration of an intermodulation measurement.

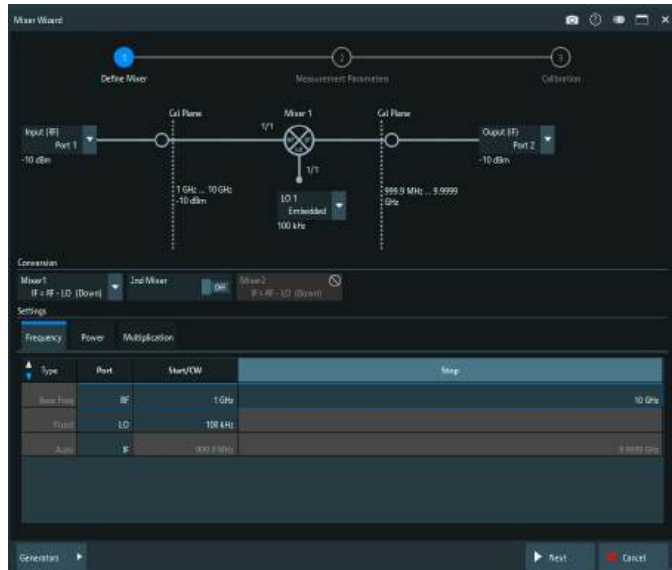

Configuring IMD measurements with an intermodulation wizard.

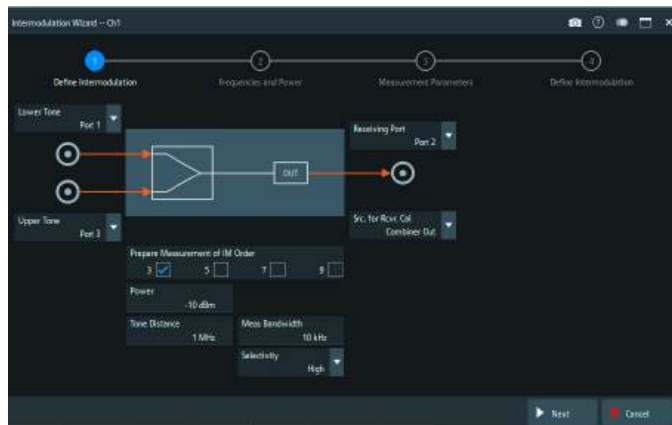



## Amplifier measurements with a wide power sweep range and receiver step attenuators

The wide, electronically adjustable power sweep range of the R&S®ZNB3000 from -85 dBm to +13 dBm enables fast analysis of the linear and nonlinear characteristics of small- and large-signal amplifiers. Electronic step attenuators in the receive paths increase the 0.1 dB compression point to +27 dBm. The wear-free attenuators feature delay-free switching, which speeds up measurements and extends the useful life of the R&S®ZNB3000.

Additional features:

- ▶ Four DC inputs for measuring amplifier DC power consumption and efficiency
- ▶ Measures stability factors of balanced and unbalanced amplifiers
- ▶ Supports R&S®NRP-Zxx power sensors, providing high-precision power versus power and power versus frequency measurements

## Frequency-converting measurements on mixers and amplifiers is quick and easy with two independent internal sources

When equipped with the R&S®ZNB3-K4 frequency conversion and R&S®ZNB3-K14 intermodulation measurement options, the R&S®ZNB3000 can measure harmonics and intermodulation products on amplifiers as well as conversion loss, matching and isolation on mixers versus frequency and power. A special calibration technique – R&S®SMARTerCal – combines absolute power

calibration with system error correction, enabling precise determination of mixer conversion loss magnitude. Wizards guide the user step by step to the desired measurement configuration and through calibration. For complex measurements, e.g. on frontends with multiple mixer stages, the R&S®ZNB3000 can control multiple external signal generators via LAN or IEC/IEEE bus.

The R&S®ZNB3000 4-port models can optionally be equipped with a second, independent internal source. This source can be used, for example, as a local oscillator in mixer measurements or to generate two-tone signals in intermodulation measurements. This feature boosts measurement speed by a factor of up to 10 compared to setups using an external generator and significantly simplifies the test setup.

## Compression point measurements

Determining the compression point is essential when characterizing amplifiers. To perform this measurement, the sweep mode is set to “Power” on the R&S®ZNB3000, and the compression point measurement can be started. The result is calculated automatically and displayed.

In addition, the R&S®ZNB3000 offers the possibility to measure compression point versus frequency with an additional option. The user can define the desired frequency grid and the compression point to be measured. The configuration is effortlessly done with an intuitive setup menu. Accuracy is guaranteed with the appropriate system error correction.

Compression point versus frequency example.



# TESTS IN VACUUM CHAMBERS AND ON MULTIPOINT DEVICES

The R&S®ZN-Z3x inline calibration units allow precise, reliable measurements even in scenarios where the user has no access to the reference plane. This is the case, for example, when performing satellite tests in thermal vacuum chambers (TVAC). The inline calibration units also enable highly efficient measurements on multipoint devices involving a large number of ports.

## TVAC (satellite) tests

When performing tests in a thermal vacuum chamber (TVAC), thermal drift effects in the test system components (e.g. RF cables, adapters, switches and pre-amplifiers) can render the original calibration invalid. R&S®ZN-Z33 inline calibration units can remain connected between the ends of the test cables and the DUT at all times, allowing fast recalibration after each change in ambient temperature. Temperature characterization for the inline calibration units at the factory ensures accurate and dependable results in a range from -30°C to +80°C.

## Multipoint measurements

Connecting or reconnecting coaxial multipoint DUTs invariably involves moving test cables. The limited phase stability of the cables can affect measurement accuracy. A phase change can occur when the cables are moved. Using an R&S®ZN-Z32 or R&S®ZN-Z33 inline calibration unit, selected groups of ports can be recalibrated at the touch of a button with no need to reconnect the cables.

## Software support for Rohde & Schwarz inline calibration units

R&S®ZNB3000 software supports all Rohde & Schwarz inline calibration units. Users can see all the required configuration steps at a glance on the R&S®ZNB3000 GUI:

- ▶ Automatic detection of all connected inline calibration units and the R&S®ZN-Z30 inline calibration unit controller
- ▶ Base calibration
- ▶ Recalibration

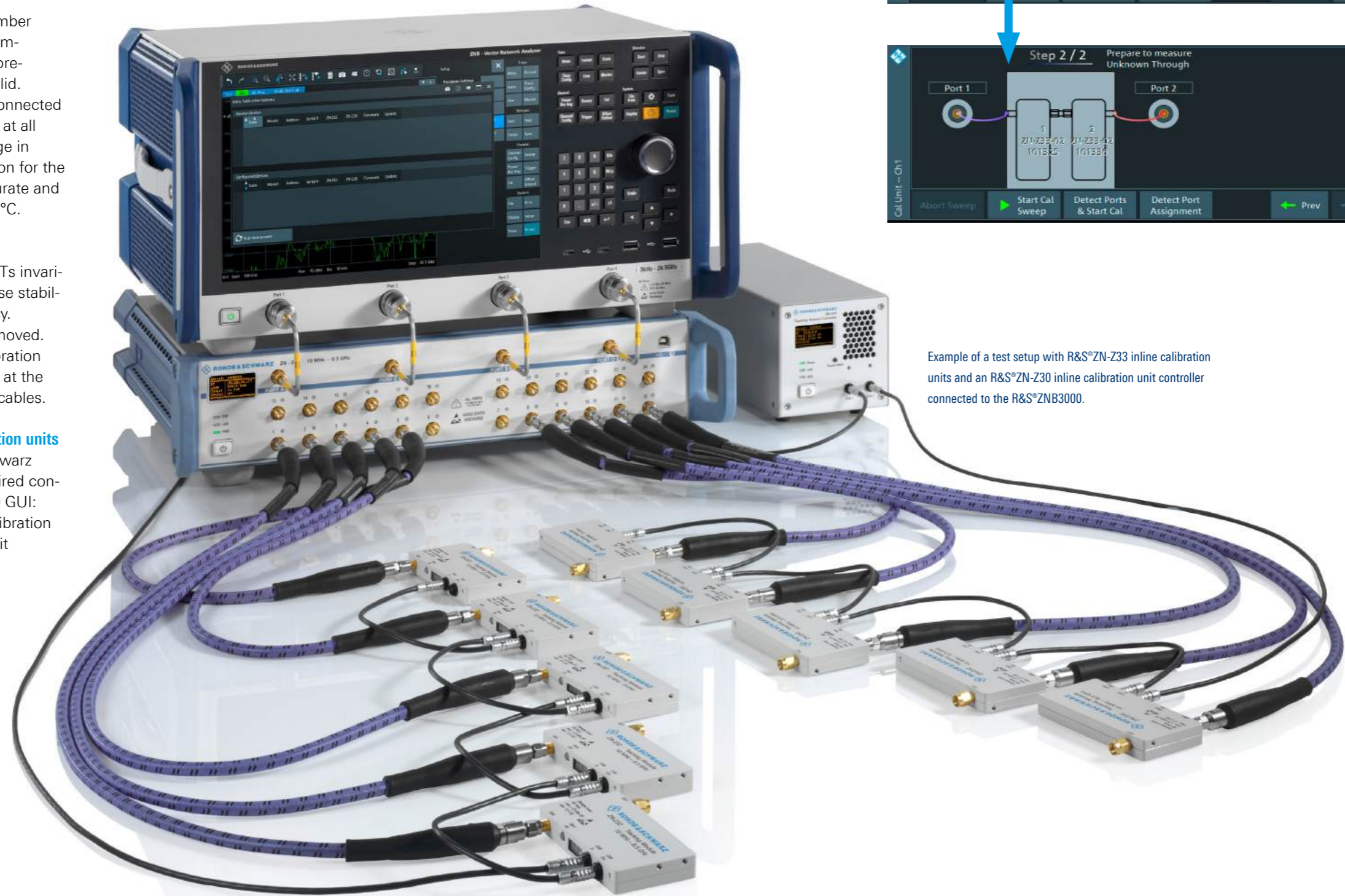

## Wizard guided test setup configuration

The R&S®ZNB3000 guides the user through the calibration steps. For base calibration, steps 1 and 2 are required; all subsequent recalibrations require step 1 only. In the calibration menu, recalibration is started at the touch of a button.



Example of a test setup with R&S®ZN-Z33 inline calibration units and an R&S®ZN-Z30 inline calibration unit controller connected to the R&S®ZNB3000.

# SPECIFICATIONS IN BRIEF

## Specifications in brief

Frequency range	R&S®ZNB3004	9 kHz to 4.5 GHz
	with R&S®ZNB3-B082 or R&S®ZNB3-B084 frequency upgrade option	9 kHz to 9 GHz
	R&S®ZNB3020	9 kHz to 20 GHz
	with R&S®ZNB3-B262 or R&S®ZNB3-B264 frequency upgrade option	9 kHz to 26.5 GHz
Number of ports		2 or 4
Dynamic range	R&S®ZNB3004 with R&S®ZNB3-B08x	≤ 140 dB (typ.)
	R&S®ZNB3004 with extended dynamic range option R&S®ZNB3-B5x	≤ 150 dB (typ.)
	R&S®ZNB3020 with or without R&S®ZNB3-B262/-B264	≤ 150 dB (typ.)
Trace noise magnitude (RMS)	R&S®ZNB3004	≤ 0.004 dB
	R&S®ZNB3020	≤ 0.0008 dB
Measurement time	R&S®ZNB3004 with R&S®ZNB3-B08x, 401 points; sweep mode: stepped frequency range: 1 MHz to 9 GHz; 5.2 ms IF bandwidth: 500 kHz; calibration: 2-port TOSM	6.5 ms
	R&S®ZNB3020 with R&S®ZNB3-B26x, 401 points; sweep mode: stepped frequency range: 1 MHz to 26.5 GHz; 5.2 ms IF bandwidth: 500 kHz; calibration: 2-port TOSM	11 ms
Output power		up to +13 dBm (typ.)
Number of points		1 to 100001
Number of channels		> 100
Number of traces		> 100
Test parameters		<ul style="list-style-type: none"> <li>▶ S-parameters (single-ended, mixed-mode)</li> <li>▶ waves and wave ratios</li> <li>▶ <math>Z &lt; -S_{ij}</math>, <math>Y &lt; -S_{ij}</math>, <math>Y/Z</math> parameters</li> <li>▶ imbalance/CMRR</li> <li>▶ stability</li> <li>▶ power</li> </ul>
Software options	R&S®ZNB3-K2	time domain analysis (TDR)
	R&S®ZNB3-K3	distance to fault (DTF)
	R&S®ZNB3-K4	frequency conversion
	R&S®ZNB3-K14	intermodulation measurements
	R&S®ZNB3-K17	10 MHz IF bandwidth
	R&S®ZNB3-K18	gain compression measurements
	R&S®ZNB3-K19	1 MHz frequency resolution
	R&S®ZNB3-K20	extended time domain analysis
	R&S®ZNB3-K30	noise figure measurement
	R&S®ZNB3-K50	real-time measurement uncertainty analysis; requires VNA Tools software from METAS, the Swiss Federal Institute of Metrology (free download from METAS website)
	R&S®ZNB3-K50P	real-time measurement uncertainty analysis with preinstalled VNA Tools software from METAS, the Swiss Federal Institute of Metrology
	R&S®ZNB3-K100	SNP assistant
	R&S®ZNB3-K210	EaZy deembedding (EZD)
	R&S®ZNB3-K220	in-situ deembedding (ISD)
	R&S®ZNB3-K230	smart fixture deembedding (SFD)
	R&S®ZNB3-K231	Delta-L 4.0 PCB characterization
	R&S®ZNB3-K980	health and utilization monitoring service (HUMS)

## Specifications in brief

Calibration methods		reflect norm open, reflect norm short, reflect OSM, trans norm, one-path two-port, TOSM, UOSM, TRL, TOM, TSM, TRM, TNA, adapter removal
Switch matrices to expand the number of ports	R&S®ZN-Z84, R&S®ZN-Z86(x)	up to 26.5 GHz, max. 2 units, up to 48 ports
Languages		Chinese, English, French, German, Italian, Japanese, Korean, Russian, Spanish and others
Dimensions	W × H × D	462.5 mm × 239.6 mm × 361.5 mm (18.2 in × 9.4 in × 14.2 in)
Weight	R&S®ZNB3004/R&S®ZNB3020, 2-port models	14 kg (31 lb)
	R&S®ZNB3004/R&S®ZNB3020, 4-port models	16 kg (35 lb)



# ORDERING INFORMATION

Designation	Type	Frequency range	Order No.
<b>Base units</b>			
Vector network analyzer, 2 ports, 4.5 GHz, N connectors	R&S®ZNB3004	9 kHz to 4.5 GHz	1351.5050.02
Vector network analyzer, 4 ports, 4.5 GHz, N connectors	R&S®ZNB3004	9 kHz to 4.5 GHz	1351.5050.04
Upgrade R&S®ZNB3004 to 9 GHz, 2 ports, N connectors	R&S®ZNB3-082	9 kHz to 9 GHz	1351.5067.02
Upgrade R&S®ZNB3004 to 9 GHz, 4 ports, N connectors	R&S®ZNB3-084	9 kHz to 9 GHz	1351.5067.04
Vector network analyzer, 2 ports, 20 GHz, 3.5 mm connectors	R&S®ZNB3020	9 kHz to 20 GHz	1351.5050.22
Vector network analyzer, 4 ports, 20 GHz, 3.5 mm connectors	R&S®ZNB3020	9 kHz to 20 GHz	1351.5050.24
Upgrade R&S®ZNB3020 to 26.5 GHz, 2 ports, 3.5 mm connectors	R&S®ZNB3-B262	9 kHz to 26.5 GHz	1351.5073.02
Upgrade R&S®ZNB3020 to 26.5 GHz, 4 ports, 3.5 mm connectors	R&S®ZNB3-B264	9 kHz to 26.5 GHz	1351.5073.04
<b>Hardware options</b>			
<b>Extended power range</b>			
Extended power range for 2-port R&S®ZNB3004	R&S®ZNB3-B22		1351.5173.02
Extended power range for 4-port R&S®ZNB3004	R&S®ZNB3-B24		1351.5180.02
Extended power range for 2-port R&S ZNB3020	R&S®ZNB3-B22		1351.5196.02
Extended power range for 4-port R&S ZNB3020	R&S®ZNB3-B24		1351.5209.02
<b>Receiver step attenuators</b>			
Receiver step attenuator, port 1, for R&S®ZNB3004	R&S®ZNB3-B31		1351.5250.02
Receiver step attenuator, port 2, for R&S®ZNB3004	R&S®ZNB3-B32		1351.5267.02
Receiver step attenuator, port 3, for R&S®ZNB3004	R&S®ZNB3-B33		1351.5273.02
Receiver step attenuator, port 4, for R&S®ZNB3004	R&S®ZNB3-B34		1351.5280.02
<b>Extended dynamic range</b>			
Extended dynamic range for 2-port R&S®ZNB3004 <sup>1)</sup>	R&S®ZNB3-B52		1351.5296.02
Extended dynamic range for 4-port R&S®ZNB3004 <sup>1)</sup>	R&S®ZNB3-B54		1351.5309.02
<b>Second internal source</b>			
Second internal source for 4-port R&S®ZNB3004	R&S®ZNB3-B2		1351.5138.02
Second internal source for 4-port R&S®ZNB3020	R&S®ZNB3-B2		1351.5144.02
<b>Further hardware options</b>			
Bias tees for 2-port R&S®ZNB3004	R&S®ZNB3-B1		1351.5115.02
Bias tees for 4-port R&S®ZNB3004	R&S®ZNB3-B1		1351.5121.02
Additional removable SSD, 512 Gbyte, Windows 11 for IPS14	R&S®ZNB3-B19		1351.5821.02
Precision frequency reference (OCXO)	R&S®ZNB-B4		1316.1769.04
GPIO interface	R&S®ZNB-B10		1311.5995.04
Device control <sup>2)</sup>	R&S®ZNB-B12		1319.5088.02
Handler I/O (universal interface)	R&S®ZNB-B14		1316.2459.05
DC inputs	R&S®ZNB-B81		1316.0004.02
External RFFE GPIO interface	R&S®ZN-Z15		1325.5905.02
External RFFE GPIO interface, including current and voltage measurements	R&S®ZN-Z15		1325.5905.03
Direct control cable <sup>2)</sup>	R&S®ZN-B121		1323.9290.00
<b>Software options</b>			
<b>Time domain analysis</b>			
Time domain analysis (TDR)	R&S®ZNB3-K2		1351.5367.02
Extended time domain analysis <sup>3)</sup>	R&S®ZNB3-K20		1351.5373.02
Distance to fault (DTF)	R&S®ZNB3-K3		1351.5380.02
<b>Frequency-converting measurements</b>			
Frequency conversion <sup>4)</sup>	R&S®ZNB3-K4		1351.5396.02
Intermodulation measurements <sup>5)</sup>	R&S®ZNB3-K14		1351.5409.02
<b>Deembedding</b>			
EaZy deembedding (EZD)	R&S®ZNB3-K210		1351.5480.02
In-situ deembedding (ISD)	R&S®ZNB3-K220		1351.5496.02
Smart fixture deembedding (SFD)	R&S®ZNB3-K230		1351.5509.02
Delta-L PCB characterization	R&S®ZNB3-K231		1351.5515.02

Designation	Type	Frequency range	Order No.
<b>Further software options</b>			
10 MHz receiver bandwidth	R&S®ZNB3-K17		1351.5421.02
Gain compression measurements	R&S®ZNB3-K18		1355.8902.02
1 millihertz frequency resolution	R&S®ZNB3-K19		1351.5438.02
Noise figure measurements	R&S®ZNB3-K30		1351.5444.02
Real-time measurement uncertainty analysis	R&S®ZNB3-K50		1351.5450.02
Real-time measurement uncertainty analysis, preinstalled	R&S®ZNB3-K50P		1351.5467.02
Health and utilization monitoring service	R&S®ZNB3-K980		1351.5521.02
<b>Switch matrices</b>			
<b>R&amp;S®ZN-Z84 switch matrix up to 8.5 GHz, with up to 24 ports</b>			
Switch matrix, base unit, 2 VNA ports to 6 matrix ports, SMA (f) <sup>6)</sup>	R&S®ZN-Z84	10 MHz to 8.5 GHz	1319.4500.02
Additional test ports 7 to 12, 4 VNA ports to 12 matrix ports <sup>7)</sup>	R&S®ZN-Z84-B24	10 MHz to 8.5 GHz	1319.4969.24
Additional test ports 7 to 12, 2 VNA ports to 12 matrix ports <sup>7)</sup>	R&S®ZN-Z84-B22	10 MHz to 8.5 GHz	1319.4969.22
Additional test ports 13 to 18, 4 VNA ports to 18 matrix ports <sup>8)</sup>	R&S®ZN-Z84-B34	10 MHz to 8.5 GHz	1319.4969.34
Additional test ports 13 to 18, 2 VNA ports to 18 matrix ports <sup>8)</sup>	R&S®ZN-Z84-B32	10 MHz to 8.5 GHz	1319.4969.32
Additional test ports 19 to 24, 4 VNA ports to 24 matrix ports <sup>9)</sup>	R&S®ZN-Z84-B44	10 MHz to 8.5 GHz	1319.4969.44
Additional test ports 19 to 24, 2 VNA ports to 24 matrix ports <sup>9)</sup>	R&S®ZN-Z84-B42	10 MHz to 8.5 GHz	1319.4969.42
<b>R&amp;S®ZN-Z86 switch matrix up to 26.5 GHz, with up to 24 ports</b>			
Switch matrix, base unit, 100 MHz to 26.5 GHz, 2 VNA ports to 6 test ports	R&S®ZN-Z86	100 MHz to 26.5 GHz	1351.2216.02
Additional test ports 7 to 12, 2 VNA ports to 12 test ports	R&S®ZN-Z86-B22	100 MHz to 26.5 GHz	1351.2900.22
Additional test ports 13 to 18, 2 VNA ports to 18 test ports	R&S®ZN-Z86-B32	100 MHz to 26.5 GHz	1351.2900.32
Additional test ports 19 to 24, 2 VNA ports to 24 test ports	R&S®ZN-Z86-B42	100 MHz to 26.5 GHz	1351.2900.42
Additional test ports 7 to 12, 4 VNA ports to 12 test ports	R&S®ZN-Z86-B24	100 MHz to 26.5 GHz	1351.2900.24
Additional test ports 13 to 18, 4 VNA ports to 18 test ports	R&S®ZN-Z86-B34	100 MHz to 26.5 GHz	1351.2900.34
Additional test ports 19 to 24, 4 VNA ports to 24 test ports	R&S®ZN-Z86-B44	100 MHz to 26.5 GHz	1351.2900.44
Semi-rigid cable set for R&S®ZNB3000, 2.92 mm (f) to 2.92 mm (m), 2 or 4 R&S®ZNB3000 ports to R&S®ZN-Z86, benchtop operation	R&S®ZN-ZB26		1328.8911.02
<b>R&amp;S®ZN-Z86X switch matrix up to 26.5 GHz, with up to 24 ports</b>			
Switch matrix, base unit, 100 MHz to 26.5 GHz, with additional RF access	R&S®ZN-Z86X	100 MHz to 26.5 GHz	1351.2222.02
Additional test ports 1 to 12, 2 or 4 VNA ports	R&S®ZNZ86X-B24	100 MHz to 26.5 GHz	1351.2222.24
Additional test ports 1 to 24, 2 or 4 VNA ports	R&S®ZNZ86X-B44	100 MHz to 26.5 GHz	1351.2222.44
Semi-rigid cable set for R&S®ZNB3000, 2.92 mm (f) to 2.92 mm (m), 2 or 4 R&S®ZNB3000 ports to R&S®ZN-Z86X, benchtop operation	R&S®ZN-ZB26		1328.8911.03
<b>Calibration</b>			
<b>Calibration kits for manual calibration – economy</b>			
Calibration kit, N (f)	R&S®ZN-Z170	0 Hz to 18 GHz	1328.8163.03
Calibration kit, 3.5 mm (f)	R&S®ZN-Z135	0 Hz to 26.5 GHz	1328.8157.03
<b>Calibration kits for manual calibration – high-end</b>			
Calibration kit, 0 Hz to 18 GHz, N, 50 Ω	R&S®ZV-Z270	0 Hz to 18 GHz	5011.6536.02
Calibration kit, 0 Hz to 26.5 GHz, 3.5 mm	R&S®ZN-Z235	0 Hz to 26.5 GHz	1336.8500.02
<b>Calibration units for automatic calibration – economy</b>			
Calibration unit, 5 kHz to 4.5 GHz, 2-port	R&S®ZN-ZE104	5 kHz to 4.5 GHz	1350.8040.04
Calibration unit, 5 kHz to 9 GHz, 2-port 19	R&S®ZN-ZE109	5 kHz to 9 GHz	1350.8040.09
Calibration unit, 5 kHz to 26.5 GHz, 2-port 19	R&S®ZN-ZE126	5 kHz to 26.5 GHz	1350.8040.26
Calibration unit, 100 kHz to 8.5 GHz, 4 ports, SMA (f)	R&S®ZN-Z153	100 kHz to 8.5 GHz	1319.6178.34
Calibration unit, 100 kHz to 8.5 GHz, 6 ports, SMA (f)	R&S®ZN-Z152	100 kHz to 8.5 GHz	1319.6003.36
Calibration unit, 100 kHz to 8.5 GHz, 6 ports, SMA (f)	R&S®ZN-Z154	100 kHz to 8.5 GHz	1319.5120.02
Additional ports 7 to 12, SMA (f)	R&S®ZNZ154-B22	100 kHz to 8.5 GHz	1319.5136.22
Additional ports 13 to 18, SMA (f)	R&S®ZNZ154-B32	100 kHz to 8.5 GHz	1319.5136.32
Additional ports 19 to 24, SMA (f)	R&S®ZNZ154-B42	100 kHz to 8.5 GHz	1319.5136.42
<b>Calibration units for automatic calibration – high-end</b>			
Calibration unit, 100 kHz to 8.5 GHz, 2 ports, N (f)	R&S®ZN-Z51	100 kHz to 8.5 GHz	1319.5507.72
Calibration unit, 100 kHz to 8.5 GHz, 4 ports, N (f)	R&S®ZN-Z51	100 kHz to 8.5 GHz	1319.5507.74
Calibration unit, 100 kHz to 8.5 GHz, 2 ports, 3.5 mm (f)	R&S®ZN-Z51	100 kHz to 8.5 GHz	1319.5507.32

Designation	Type	Frequency range	Order No.
Calibration unit, 100 kHz to 8.5 GHz, 4 ports, 3.5 mm (f)	R&S®ZN-Z51	100 kHz to 8.5 GHz	1319.5507.34
Calibration unit, 9 kHz to 9 GHz, 2 ports, 3.5 mm (f)	R&S®ZN-Z50	9 kHz to 9 GHz	1335.6904.30
Calibration unit, 9 kHz to 26.5 GHz, 2 ports, 3.5 mm (f)	R&S®ZN-Z50	9 kHz to 26.5 GHz	1335.6904.32
Calibration unit, 100 kHz to 26.5 GHz, 4 ports, 3.5 mm (f)	R&S®ZN-Z52	100 kHz to 26.5 GHz	1335.6991.30
Calibration unit, 100 kHz to 26.5 GHz, 2 ports, 3.5 mm (f)	R&S®ZN-Z53	100 kHz to 26.5 GHz	1335.7046.32
Calibration unit, 100 kHz to 18 GHz, 2 ports, N (f)	R&S®ZN-Z53	100 kHz to 18 GHz	1335.7046.72
<b>Inline calibration units for automatic calibration – high-end</b>			
CAN bus controller for inline calibration units	R&S®ZN-Z30		1328.7609.02
Inline calibration unit, 10 MHz to 8.5 GHz	R&S®ZN-Z32	10 MHz to 8.5 GHz	1328.7638.02
Inline calibration unit, 10 MHz to 40 GHz, characterized to 43.5 GHz	R&S®ZN-Z33	10 MHz to 40 GHz	1328.7644.02
Inline calibration unit, 10 MHz to 40 GHz, for TVAC, characterized to 43.5 GHz	R&S®ZN-Z33	10 MHz to 40 GHz	1328.7644.03
Thermal insulator, 2.92 mm	R&S®ZN-Z391		1350.8504.02
<b>Test cables</b>			
0 Hz to 18 GHz, N (m) to N (m), 50 Ω, length: 0.6 m/1 m	R&S®ZV-Z91	0 Hz to 18 GHz	1301.7572.25/.38
0 Hz to 18 GHz, N (m) to N (m), 50 Ω, length: 0.6 m/0.9 m	R&S®ZV-Z191	0 Hz to 18 GHz	1306.4507.24/.36
0 Hz to 18 GHz, N (m) to 3.5 mm (m), 50 Ω, length: 0.6 m/1 m	R&S®ZV-Z92	0 Hz to 18 GHz	1301.7589.25/.38
0 Hz to 18 GHz, N (m) to 3.5 mm (m), 50 Ω, length: 0.6 m/0.9 m	R&S®ZV-Z192	0 Hz to 18 GHz	1306.4513.24/.36
0 Hz to 26.5 GHz, 3.5 mm (f) to 3.5 mm (m), length: 0.6 m/1 m	R&S®ZV-Z93	0 Hz to 26.5 GHz	1301.7595.25/.38
0 Hz to 26.5 GHz, 3.5 mm (f) to 3.5 mm (m), length: 0.6 m/0.9 m/1.5 m	R&S®ZV-Z193	0 Hz to 26.5 GHz	1306.4520.24/.36/.60
0 Hz to 40 GHz, 2.92 mm (f) to 2.92 mm (m), length: 0.6 m/1.0 m	R&S®ZV-Z95	0 Hz to 40 GHz	1301.7608.25/.38
0 Hz to 40 GHz, 2.92 mm (f) to 2.92 mm (m), length: 0.6 m/0.9 m	R&S®ZV-Z195	0 Hz to 40 GHz	1306.4536.24/.36
0 Hz to 50 GHz, 2.4 mm (f) to 2.4 mm (m), length: 0.6 m	R&S®ZV-Z97	0 Hz to 50 GHz	1301.7637.25

<sup>1)</sup> Cannot be combined with R&S®ZNB3-B1 or R&S®ZNB3-B3x.

<sup>2)</sup> Required for direct control of R&S®ZN-Z84/R&S®ZN-Z85 switch matrix and R&S®ZN-Z15 external RFFE GPIO interface.

<sup>3)</sup> Requires R&S®ZNB3-K2.

<sup>4)</sup> Requires R&S®ZVAB-B44 for control of external sources via the IEC/IEEE bus.

<sup>5)</sup> Requires R&S®ZNB3-K4.

<sup>6)</sup> Includes cables for connecting an R&S®ZN-Z84 switch matrix to an R&S®ZNB3004/R&S®ZNB3020 analyzer.

<sup>7)</sup> Requires R&S®ZN-Z84.

<sup>8)</sup> Requires R&S®ZN-Z84-B2x.

<sup>9)</sup> Requires R&S®ZN-Z84-B3x.

Service at Rohde & Schwarz

# YOU'RE IN GREAT HANDS

	SERVICE PLANS	ON DEMAND
Calibration	Up to five years <sup>1)</sup>	Pay per calibration
Warranty and repair	Up to five years <sup>1)</sup>	Standard price repair

<sup>1)</sup> For extended periods, contact your Rohde & Schwarz sales office.

## Instrument management made easy

The R&S® InstrumentManager makes it easy to register and manage your instruments. It lets you schedule calibration dates and book services.

Find out more  
about our service  
portfolio under:



The Bluetooth® word mark and logos are registered trademarks owned by Bluetooth SIG, Inc. and any use of such marks by Rohde & Schwarz is under license.  
The terms HDMI and HDMI High-Definition Multimedia Interface, and the HDMI Logo are trademarks or registered trademarks of HDMI Licensing, LLC in the United States and other countries.  
MIPI marks and logos are service marks owned by MIPI Alliance, Inc. and any use of such marks by Rohde & Schwarz is under license.



**Service at Rohde & Schwarz**  
**You're in great hands**

- ▶ Worldwide
- ▶ Local and personalized
- ▶ Customized and flexible
- ▶ Uncompromising quality
- ▶ Long-term dependability

**MAKE IDEAS REAL**  
and join our experts team  
at Rohde & Schwarz.



**dataTec**

Mess- und Prüftechnik. Die Experten.

**Ihr Ansprechpartner /  
Your Partner:**

**dataTec AG**

E-Mail: [info@datatec.eu](mailto:info@datatec.eu)

>>> [www.datatec.eu](http://www.datatec.eu)

**Rohde & Schwarz**

The Rohde&Schwarz technology group is among the trail-blazers when it comes to paving the way for a safer and connected world with its leading solutions in test & measurement, technology systems and networks & cybersecurity. Founded 90 years ago, the group is a reliable partner for industry and government customers around the globe. The independent company is headquartered in Munich, Germany and has an extensive sales and service network with locations in more than 70 countries.

[www.rohde-schwarz.com](http://www.rohde-schwarz.com)

**Sustainable product design**

- ▶ Environmental compatibility and eco-footprint
- ▶ Energy efficiency and low emissions
- ▶ Longevity and optimized total cost of ownership

Certified Quality Management  
**ISO 9001**

Certified Environmental Management  
**ISO 14001**

**Rohde & Schwarz training**

[www.training.rohde-schwarz.com](http://www.training.rohde-schwarz.com)

**Rohde & Schwarz customer support**

[www.rohde-schwarz.com/support](http://www.rohde-schwarz.com/support)

