

R&S® ESSENTIALS

R&S® RT-ZISO ISOLATED PROBING SYSTEM

High voltage. Optical isolation. Seamless interface.

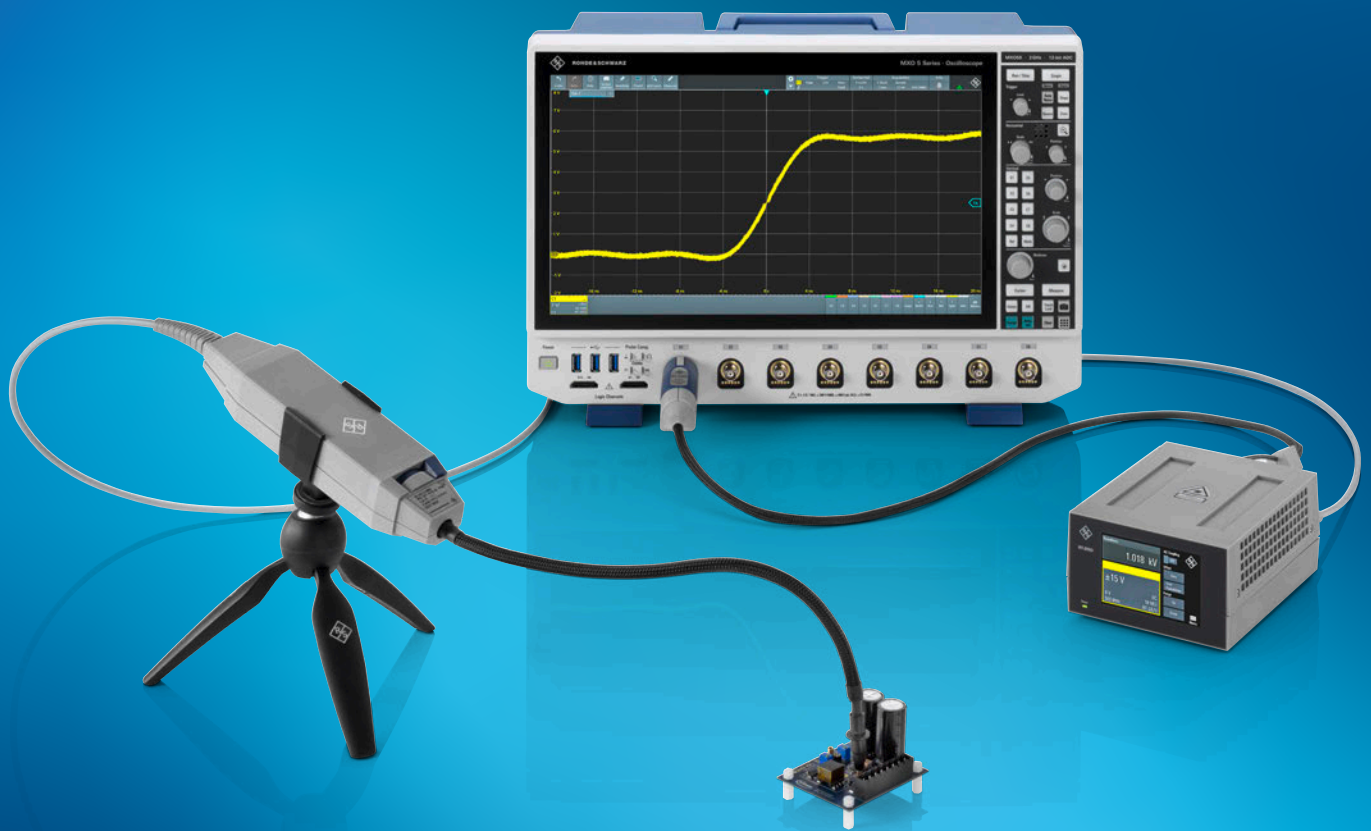

Product Brochure
Version 01.00

ROHDE & SCHWARZ

Make ideas real



Mess- und Prüftechnik. Die Experten.

Ihr Ansprechpartner /
Your Partner:

dataTec AG

E-Mail: info@datatec.eu

>>> www.datatec.eu



NEXT GENERATION GROUND BREAKING SOLUTION

The R&S®RT-ZISO isolated probing system sets new standards for isolated probe technology. The innovative solution delivers unparalleled accuracy, sensitivity, dynamic range and bandwidth, while enabling next-generation wide bandgap (WBG) SiC and GaN power designs. The remarkable performance at the core of the solution provides precise differential measurements up to ± 3000 V on reference voltage levels of ± 60 kV with rise time of < 450 ps. Most importantly, the solution can suppress fast common mode signals that distort and disturb accurate measurements.

Key features

- ▶ 100 MHz to 1 GHz bandwidth (upgradeable)
- ▶ > 90 dB ($> 30\,000:1$) CMRR at 1 GHz
- ▶ ± 3000 V differential input and offset range
- ▶ ± 60 kV CMRR range
- ▶ ± 10 mV sensitive input range
- ▶ Dual connectivity with Rohde&Schwarz probe interface or SMA

Versatile and accurate probing

The micro-miniature coaxial (MMCX) connector has improved noise shielding and is widely used in WBG testing solutions. The connector ensures smaller commutation loops and minimizes parasitic capacitance that can cause high common mode noise in circuits. A voltage rating of 170 V (RMS) in continuous mode and a maximum rating of 500 V (RMS) make it the ideal probe point in transistor gate nodes.

The R&S®RT-ZISO caters to measurement needs and has MMCX probe tips with 8 V (RMS) ± 45 V (peak) (1.5x) and ± 300 V (10x) ranges. The probe tips also have sockets for 2.54 mm pitched square pins and 5.08 mm pitched wide square pins available for more common measurement setups. The R&S®RT-ZISO also comes with a standard isolated passive probe that can be used for quick measurements with safety rating of 1000 V CAT III.

Optical isolation

The R&S®RT-ZISO isolated probing system is designed for measurement challenges in high voltage and fast switching environments. The power-over-fiber architecture galvanically isolates the device under test (DUT) from the measurement setup for the highest common mode rejection ratio (CMRR) up to 1 GHz. The complete system compensates thermal drifts and corrects gain errors for the highest signal fidelity without compromise.

Applications

Evolving WBG technologies such as SiC, GaN FET and improved IGBT devices, offers faster slew rates and higher voltage levels and to have their circuit topologies characterized in detail:

- ▶ Switching converters with WBG devices
- ▶ Double-pulse testing
- ▶ Floating measurements
- ▶ Shunt measurements
- ▶ Inverter design
- ▶ Motor drive analysis

AT A GLANCE

Probe head

- ▶ Electrical to optical converter on probe signal
- ▶ SMA interface to probe tips

Probe tips

- ▶ Safe attach feature to easily interface different probe tips
- ▶ Automatic tip identification

Probe receiver

- ▶ Touchscreen control for probe settings
- ▶ R&S®ProbeMeter readout for high precision RMS value
- ▶ Signal conditioning and compensation

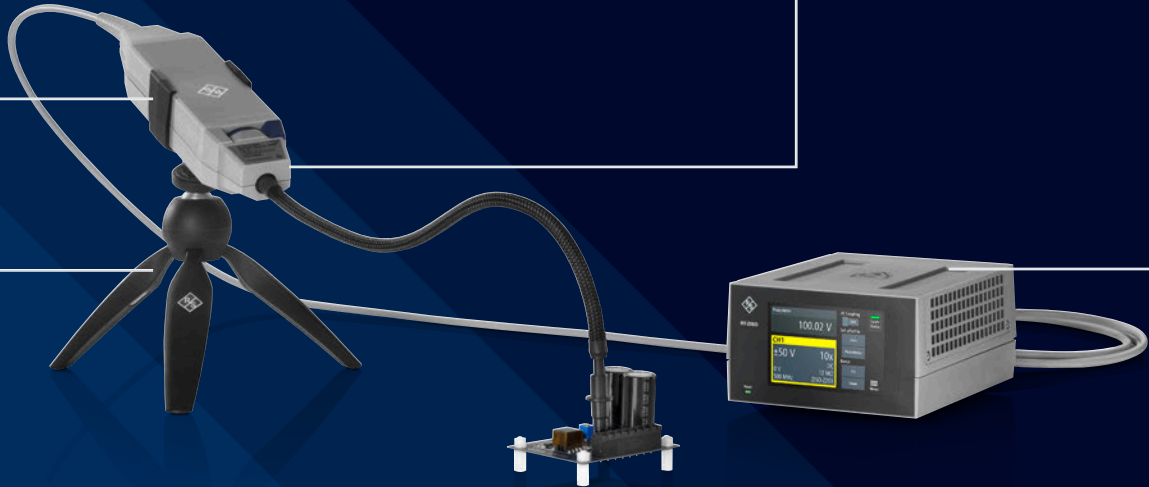

Probe stand

- ▶ Flexible and stable probe setup
- ▶ Support tripod stand with 1/4 20 UNC thread

Probe tips for different probing need

- ▶ Probe tips support for MMCX, square pins, wide square pins and isolated passive probes
- ▶ Hand-formable and long tip cables provide easy access while maintaining a low mechanical stress on the probe point

Probe receiver interface (back)

- ▶ Supports Rohde & Schwarz probe interface and SMA to BNC connection to any oscilloscope



FAST COMMON MODE PROBING CHALLENGES

Common mode signals can be on a totem-pole complementary FET setup in a half-bridge converter, synchronous rectifier, bidirectional switch, etc. In high-side gate-drain measurements, rapidly changing voltage levels on switch nodes are challenging for conventional high voltage differential probes, which struggle to attenuate the common mode signals at high frequencies.

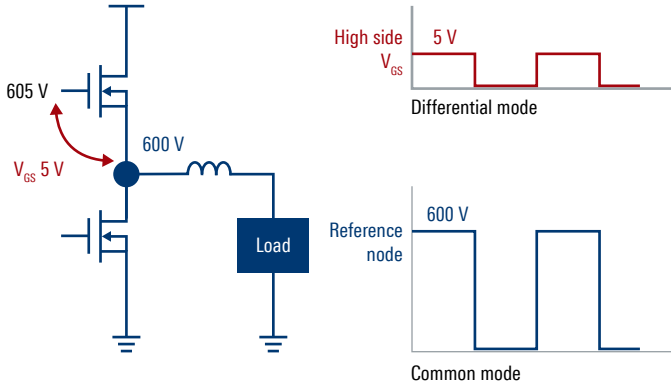

In isolated power conversion designs, the lack of a common ground leaves DUT floating. A measurement setup with an earth reference could form a large ground loop that couples common mode noise and affects sensitive test results. This is especially common in designs for high power, three-phase inverters and motor drives.

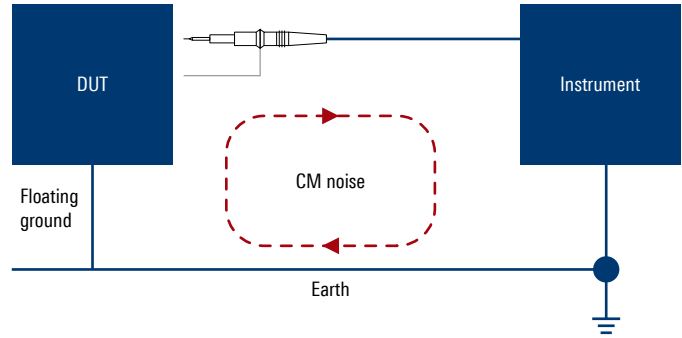

CMRR limitations for conventional probing solutions

High voltage differential probes are the most popular solution for power related measurements. The differential input compares the voltage difference on the positive (+) and negative (-) nodes, producing the difference between the probe leads. Common mode noise on both leads will be canceled out by the comparator. How effectively the probe can suppress common mode signals on the input is defined by common mode rejection ratio (CMRR).

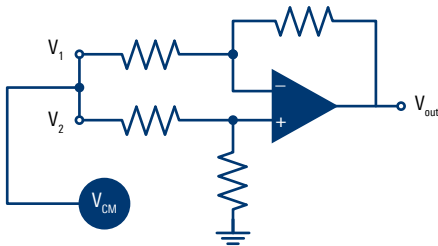

$$V_{out} = A_{dm}(V_1 - V_2) + A_{cm}(V_{cm})$$

$$CMRR = \left(\frac{A_{dm}}{|A_{cm}|} \right)$$

$$CMRR_{dB} = 20 \log_{10} \left(\frac{A_{dm}}{|A_{cm}|} \right)$$

Increased bandwidth for derating CMRR and voltage

Most high voltage differential probes have excellent CMRR ratings at low frequencies (< 100 Hz). These probes rely on the matching two internal input dividers. As frequency decrease, parasitic effects increase and matching become more difficult, if not impossible. As a result, the CMRR and voltage rating drops when the frequency (slew rate) for signals increases.

Conventional high voltage differential probes may only have < 30 dB of CMRR at their rated operation frequency from 100 MHz to 200 MHz. In scenarios where the CMRR is not important, these probes can still do the job.

CMRR for a typical high voltage differential probe in dB

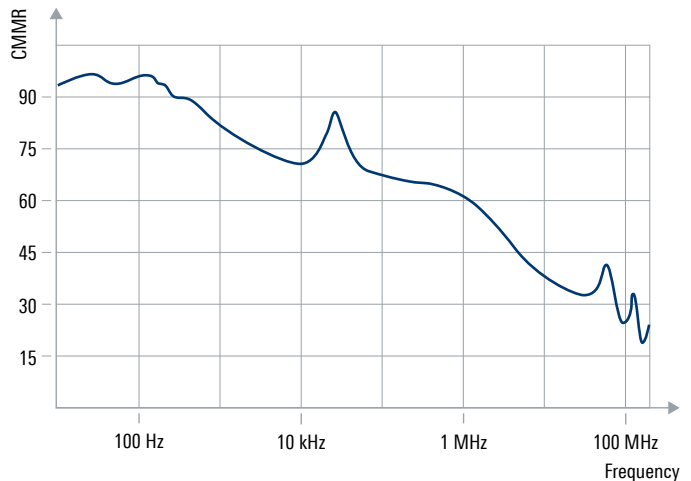

ISOLATION WITH OPTICAL FIBER

To reduce common noise loops, breaking away from the ground connection is important. The R&S®RT-ZISO isolated probing system uses lasers to communicate between the probe head and the probe receiver to limit the possible electrical return path for common mode signals. The probe tip and the probe head are essentially floating and measurements are optically transmitted to the probe receiver. Even when the instrument and DUT can be connected on the same ground plane, the lack of an electrical path completely isolates the common mode loops.

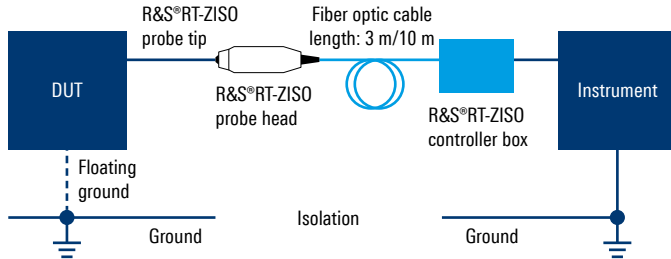

The signal transmission from the probe head to the probe receiver box is made with an optical connection and the necessary power supply for the probe head is transmitted over fiber. The probe head does not need an external power source, limiting the possibility of another common mode loop, unless an isolated source such as a battery is used.

Another benefit of optical fiber cable for isolation is the flexibility in measurement distances. Especially in critical high-power environments, high frequency and strong common mode noise limit the safe proximity to the DUT. The R&S®RT-ZISO can have optical fiber cables of 3 m or 10 m for a setup.

Bandwidth

While the R&S®RT-ZISO is designed for power applications, the most important factor is its CMRR at high bandwidths. Faster rise and fall times in switching are critical for bandwidth requirements.



> 90 dB CMRR with ± 60 kV at 1 GHz

100 MHz to 1 GHz bandwidth

± 3000 V input and offset range

Dual connectivity modes

Bandwidth options	R&S®ZISO-B901	R&S®ZISO-B902	R&S®ZISO-B903	R&S®ZISO-B905	R&S®ZISO-B910
Bandwidth	100 MHz	200 MHz	350 MHz	500 MHz	1 GHz
Rise time (10% to 90%)	< 4 ns	< 2 ns	< 1.14 ns	< 800 ps	< 450 ps

PROBE TIPS MATTER



Probe tips and connectors also have a big impact on CMRR. One reason why conventional high voltage differentials struggle to meet requirements is that the connection to the probe point is usually a 4 mm banana with plugs and jacks, often with crocodile clamps or long needle tips. These connections are needed for safety when using high voltage and for maintaining sufficient creepage distance. The slight mismatch in the signal path between +ve and -ve terminals reduces the effectiveness of differential operational amplifiers when suppressing common mode noise. Long cables and a lack of shielding also make it susceptible to common mode noise around the DUT.

R&S®RT-ZISO has a variety of probe tips. The MMCX probe tip is vital to CMRR performance. The coaxial approach shields the signal path to minimize interference. The uniform coaxial distance of the tip cable also helps reduce the size of the common mode loop. To maximize the measured signal fidelity, test points should be designed with the MMCX in mind. Square and wide square pin sockets tips are also available but lose some of the CMRR at high frequency range.

R&S®ZISO-Z101: MMCX, 1.5x, 8 V (RMS), ±45 V (peak); R&S®ZISO-Z201: MMCX, 10x, ±300 V

The MMCX connector has the best signal fidelity with an excellent CMRR at high bandwidths. For measurements with < 700 ps rise time, consider using test points with an MMCX connector. The lower attenuation for the probe tip can only support limited input and offset range, but this is also on the extension of the MMCX rated input.

R&S®ZISO-Z202: square pin (SQPIN), 25x, ±750 V, 2.54 mm pitch

Even though the square pin can be easily assessed as a test point during design, realize that the proximity may not meet creepage requirements and can lead to arcing. The R&S®ZISO-Z202 square pins can measure up to ±750 V and provide the same ±750 V offset range. As mentioned earlier, the CMRR performance and voltage range degrades as bandwidth increases.

R&S®ZISO-Z203: wide square pin (WSQPIN), 100x, ± 3000 V (peak), 5.08 mm pitch

When voltage increases, the greater creepage distance requires larger distances between exposed test leads. The wide square pin tips are suitable here and support larger input voltage ranges and offsets.

R&S®ZISO-Z301: browser, 10x, ±300 V; R&S®ZISO-Z302: browser, 100x, ±3000 V

Isolated browsers are very useful for quick measurements on DUTs without dedicated test points. Their 120 cm long tip cables are flexible enough for functional testing and troubleshooting.



The isolated probing system setup from Rohde & Schwarz focuses on safety. The probe system has a CAT III rating and various probe tips are designed to limit exposure to metal contact points.

Probe tips key performance

Parameter	R&S® ZISO-Z101	R&S® ZISO-Z201	R&S® ZISO-Z202	R&S® ZISO-Z203	R&S® ZISO-Z301	R&S® ZISO-Z302
Input interface	MMCX	MMCX	square pin (2.54 mm)	wide square pin (5.06 mm)	browner	browner
Cable length	37 cm; 14"	21 cm; 8"	32 cm; 12"	38 cm; 15"	120 cm; 47"	120 cm; 47"
Attenuation	1.5x	10x	25x	100x	10x	100x
DC input resistance	50 Ω	10 MΩ	10 MΩ	40 MΩ	10 MΩ	100 MΩ
Input capacitance	< -20 dB ¹⁾	3.7 pF	3.5 pF	3.2 pF	12 pF	4.6 pF
Maximum measurement input voltage	8 V (RMS), ±45 V (peak)	±300 V	±750 V	±3000 V (peak)	±300 V	±3000 V
Adjustable offset voltage	±45 V	±300 V	±750 V	±3000 V	±300 V	±3000 V
Voltage to earth	1000 V CAT III	1000 V CAT III	1000 V CAT III	1000 V CAT III	300 V CAT III	1000 V CAT III
Temperature loading	0°C to +40°C					

¹⁾ R&S® ZISO-Z101 is a 50 Ω match impedance so dB value indicates the reflection coefficient.

Probe tip CMRR performance and input voltage derating over frequency

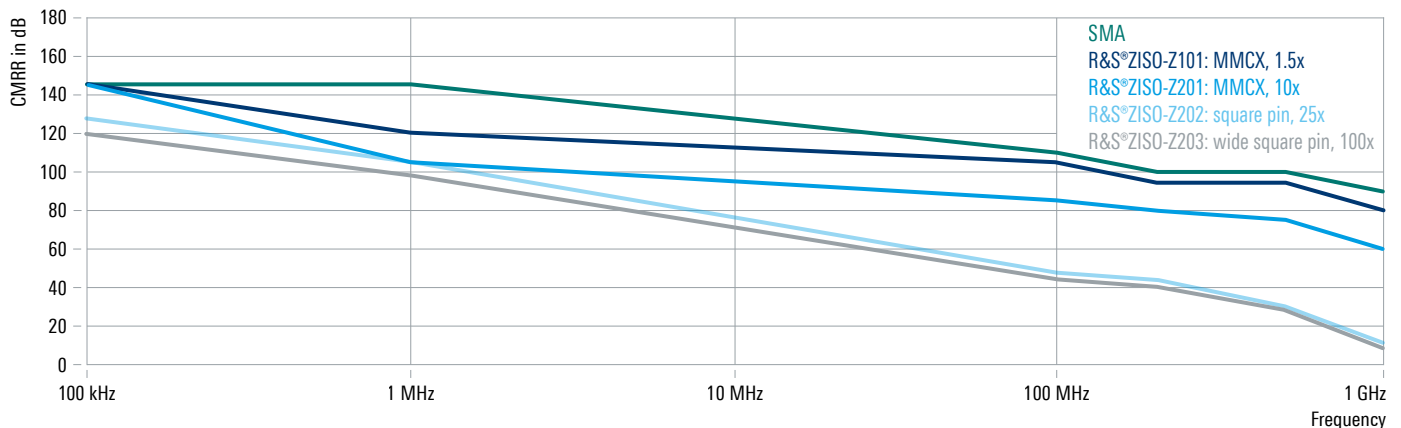

Mechanical factors

DUTs come in different sizes and a suitable test point is often in a very awkward location. So, we designed a solution with a longer probe tip and a flexible, hand-formable cable. To provide the best noise suppression for the coaxial cable, additional shielding can also make the cable heavy. The cable allows the probe tip to be bent and shaped into the desired angle to minimize stress on the connection point. The MMCX has a minimum axial force of 20 N for detaching.

In power applications, components on a DUT typically get really hot. For a good measurement with a test point close by, surface mount (SMD) connector types can easily give way when overstressed by the probe tip weight. Through-hole connectors can secure the probe tip better, but also impact the circuit board layout to allocate space in all layers for the connector. The R&S® RT-ZISO aims to minimize such mechanical loads for better probe access.



HIGH-SIDE MEASUREMENT

In switch mode power topologies, half-bridge and totem-pole setups are fairly common. To optimize efficiency, designers need to note switching transients and gate timing. High-side measurements are challenging due to the lack of ground references. Fast and high voltage switching of a source node presents fast common signals between the gate and source of the high-side device. When characterizing such power devices with double pulse testing, devices on the high-side configuration are tested. Input characteristics dominated by Miller capacitance can be difficult to observe when common mode interference is present.

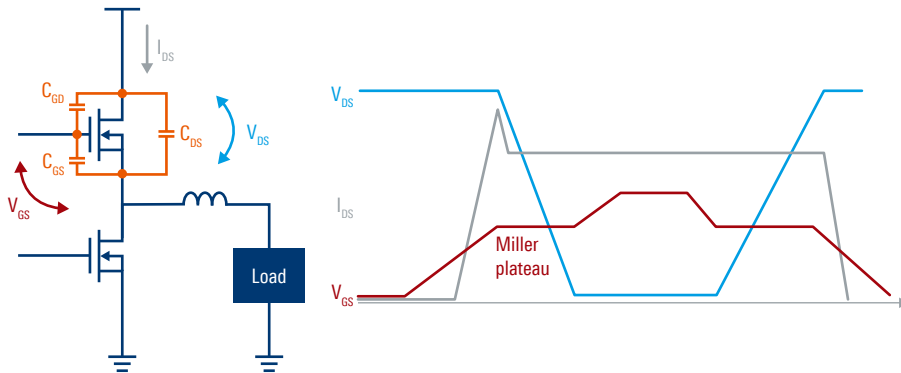

The screenshot below is a capture of the high-side gate to source measurement with the R&S®RT-ZISO. The slight dip of about 1.85 ns is the Miller plateau that the CM switching signal at the source node of the high-side transistor would otherwise obscure. Faster switching nodes help circuits respond faster to changing loads and effectively reduce switching losses when transistors turn on/off. Conventional high voltage differential probes with limited CMRR at high frequencies face challenges when measuring designs that use newer technologies and architecture.



SHUNT CURRENT MEASUREMENT

The pristine noise performance and high sensitivity of the R&S®RT-ZISO isolated probe system can also be used for high bandwidth current sensing. Traditional current measurements with Hall effect sensors, transformer coils and Rogowski coils are limited by their ability to keep up with changes in magnetic fields from the fast switching current. Shunt resistor current measurements offer higher bandwidth and are a cost-effective approach. Lower shunt values limit power dissipation and burden voltage but are highly sensitive to noise. Voltage levels in shunt resistors will be high and good CMRR performance is critical for an isolated probing system.

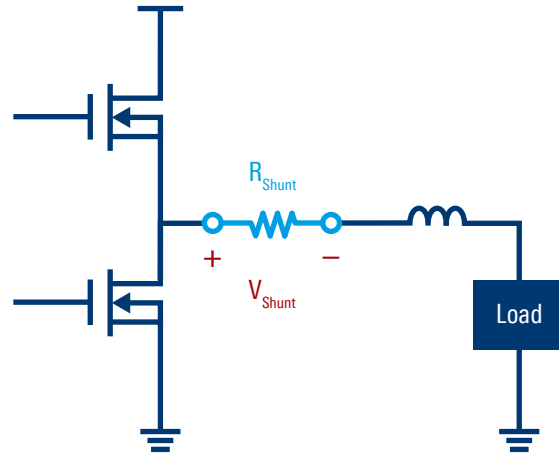

DC characteristics

Attenuation error	after self-alignment	
	input voltage range < ± 0.01 V	$\pm 1.5\%$ full scale
	input voltage range ± 0.01 V	$\pm 2.5\%$ full scale
Temperature drift, attenuation		$\pm 0.15\%/^{\circ}\text{C}$ (meas.)
Zero error	after self-alignment (input related)	± 0.5 mV $\pm 0.02 \times$ input voltage range
Offset compensation range	in all attenuation settings applicable	± 30 V

Sensitivity and noise

Input range	R&S®ZISO-B901 (100 MHz)	R&S®ZISO-B902 (200 MHz)	R&S®ZISO-B903 (350 MHz)	R&S®ZISO-B905 (500 MHz)	R&S®ZISO-B910 (1 GHz)
± 0.01 V	107 μV	121 μV	153 μV	172 μV	245 μV
± 0.025 V	140 μV	161 μV	220 μV	252 μV	383 μV
± 0.05 V	211 μV	255 μV	363 μV	417 μV	623 μV
± 0.1 V	382 μV	465 μV	683 μV	780 μV	1.16 mV
± 0.5 V	1.84 mV	2.26 mV	3.35 mV	3.81 mV	5.65 mV
± 1 V	5.90 mV	7.27 mV	9.49 mV	10.9 mV	16.0 mV

Noise performance depends highly on input bandwidth and requires a high CMRR for fast switching current measurements. The R&S®RT-ZISO offers the highest sensitivity in the industry, down to ± 5 mV range and offering superb noise performance.

Frequency response and thermal stability is even more important. Each probe head comes with Rohde&Schwarz designed ASICs trimmed to have a flat frequency response and optimized for long-term thermal performance.

CONNECT

The R&S®RT-ZISO with Rohde&Schwarz probe interfaces on an oscilloscope offers a seamless probe system experience. When connected to a Rohde&Schwarz oscilloscope, the instrument captures and sets up probe tip information to match the attenuation and range on the receiver. Offset and range control can be easily configured on the instrument. The Rohde&Schwarz probe interface also delivers power to the probe system directly. Setting up the R&S®RT-ZISO with a Rohde&Schwarz oscilloscope ensures the correct settings for your measurement. The Rohde&Schwarz oscilloscope lets you use the probe with the world fastest waveform acquisition capability, highest 18-bit HD resolution and features such as zone trigger and fast spectrum for quick design insights.



The R&S®RT-ZISO isolated probing system lets you connect to any oscilloscope with a BNC or SMA interface. The probe receiver comes with a touchscreen display to control and view probe system settings, for easier control of the probe range and offset settings while also indicating the connected probe tip.

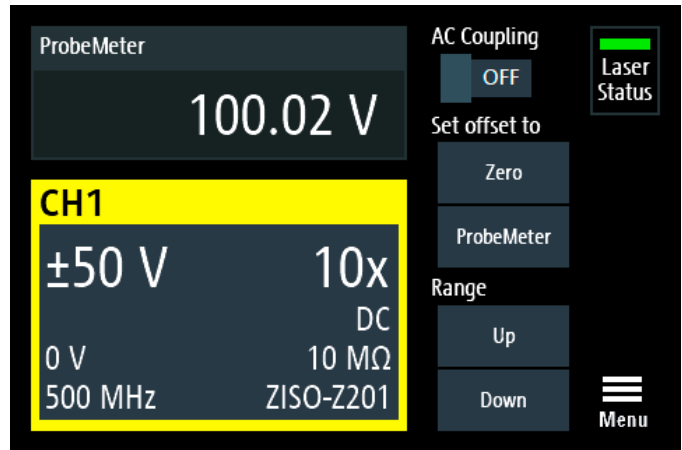

Protecting your investment

If you worry about project overhead costs and needing to decide early on the probe bandwidth, the R&S®RT-ZISO bandwidth can be easily upgraded. The 100 MHz bandwidth has the lowest entry level price for a probe system. Users can upgrade probe bandwidth later instead of buying a brand-new probe. The probe has an agnostic instrument interface and investments in Rohde&Schwarz solutions for fast and high common mode measurements can be made incrementally. The probe system can work with any third-party oscilloscope for a flexible setup.



Upgrading and servicing the isolated probing system requires hardware changes. To meet the voltage specifications, calibration can be done in-house at any Rohde&Schwarz service center near you.

Bandwidth upgrade options	
R&S®ZISO-B202	upgrade to 200 MHz
R&S®ZISO-B203	upgrade to 350 MHz
R&S®ZISO-B205	upgrade to 500 MHz
R&S®ZISO-B210	upgrade to 1 GHz

TEST SAFELY

Safety is often overlooked in isolated probing systems. High frequency and high power CMRRs are vital to isolation and make test environments extremely challenging. The input and CMRR ranges specify the maximum nondestructive voltage a probe must have to function properly. Even more important is the IEC/EN61010-31 safety rating which focuses on the safety requirements for handheld probe assemblies in electrical measurements and tests. The R&S®RT-ZISO isolated probing system adheres to these specifications and strictly follows them for a maximum rated input voltage of 1000 V (RMS) CAT III.

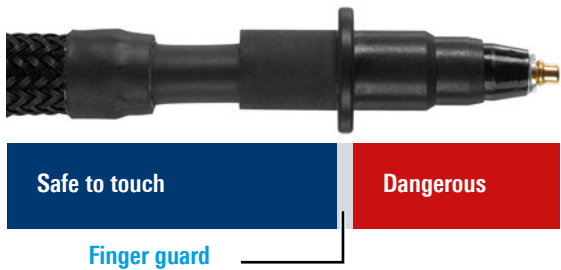

CAT III 1000 V safety rating

The probe head is designed with highest isolation in mind to minimize exposed metal during operation. The probe tips are designed with isolation caps that indicate the safe handling zone. This allows R&S®ZISO-Z301 and R&S®ZISO-Z302 isolated passive probes to be used for quick access to measurement locations when debugging.



Safe attach on probe tips

Another innovation on the R&S®ZISO is the safe attach feature on the probe tips. The quick lever allows the tips to be secured quickly and safely to the probe head without the need of additional tools such as wrenches or having to be manually screwed in the tips. Overtightening of the SMA connector could eventually damage the contact and degrade the signal and isolation performance. By limiting direct contact to the metal conductor, helps prevent electrostatic discharge (ESD) on the sensitive probe tips and heads.

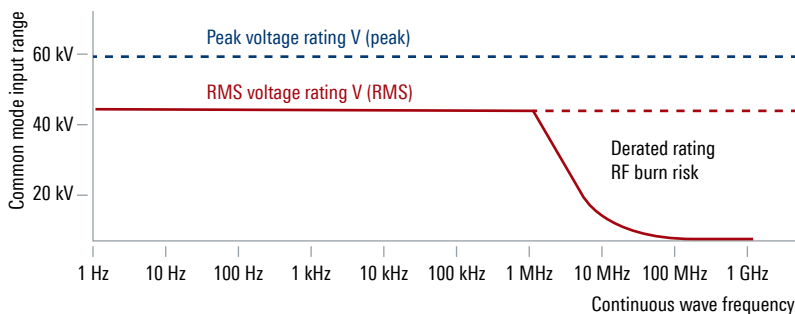

RF burn zone

At high frequencies, a viable electrical path for common mode noise can even be found over the air. Keeping a distance of 1 m around the probe head prevents possible RF burn when handling probes, when DUTs are expected to have high power and fast CM noise.

Laser safety

The lasers provide power and exchange waveform information between the probe head and receiver. Laser safety is very important when operating the isolated probing system. R&S®RT-ZISO complies with IEC 60825-1 as a class 1 laser when in operation. The optical power transmission is also continuously monitored and switched off the optical fiber cable might potentially be damaged.

Safety characteristics		
Maximum rated input voltage	continuous voltage	1000 V (RMS) CAT III
	transient voltage (socket to ground)	±4500 V (peak)
Electrical safety		in line with IEC/EN61010-1, IEC/EN61010-031
Laser safety		in line with IEC 60825-1, class 1

SPECIFICATIONS IN BRIEF

R&S®RT-ZISO isolated probing system

Step response		
Rise time	10% to 90%	
	with R&S®ZISO-B901 option	< 4 ns
	with R&S®ZISO-B902 option or -Z202 upgrade	< 2 ns
	with R&S®ZISO-B903 option or -Z203 upgrade	< 1.14 ns
	with R&S®ZISO-B905 option or -Z205 upgrade	< 800 ps
	with R&S®ZISO-B910 option or -Z210 upgrade	< 450 ps
Flatness	starting 10 ns after edge	3% (meas.)
Propagation delay	incl. oscilloscope connector cable	
	with R&S®ZISO-B403 option (3 m optical fiber cable)	27 ns (meas.)
	with R&S®ZISO-B410 option (10 m optical fiber cable)	63 ns (meas.)

Frequency response		
Bandwidth	starting at DC, calculated from 0.45/rise time	
	with R&S®ZISO-B901 option	100 MHz
	with R&S®ZISO-B902 option or -Z202 upgrade	200 MHz
	with R&S®ZISO-B903 option or -Z203 upgrade	350 MHz
	with R&S®ZISO-B905 option or -Z205 upgrade	500 MHz
	with R&S®ZISO-B910 option or -Z210 upgrade	1 GHz
Flatness	1 kHz up to half of the system bandwidth	0.2 dB (meas.)
Common mode rejection (meas.)	DC	145 dB
	1 MHz	145 dB
	100 MHz	110 dB
	200 MHz	100 dB
	500 MHz	100 dB
	1 GHz	90 dB

Input impedance		
DC input resistance		1 M Ω \pm 1%
Input capacitance		8 pF (meas.)

DC characteristics		
Attenuation		0.04:1
	automatically set by oscilloscope vertical setting (supported by MXO series, R&S®RTO6 and R&S®RTP oscilloscopes with Rohde&Schwarz probe interface; manual settings required for SMA/BNC connections with 50 Ω coupling; can be attached to oscilloscopes with 1 M Ω input coupling using a BNC feedthrough termination adapter)	0.01:1
		0.2:1
		0.4:1
		2:1
		4:1
		20:1
		40:1
		120:1
Attenuation error	after self-alignment	
	input voltage range > \pm 0.01 V	\pm 1.5% full scale
	input voltage range \pm 0.01 V	\pm 2.5% full scale
Temperature drift, attenuation		\pm 0.15%/°C (meas.)
Zero error	after self-alignment (input related)	\pm 0.5 mV \pm 0.02 \times input voltage range

Dynamic range		
Input voltage range	0.04:1	±0.01 V
	0.1:1	±0.025 V
	0.2:1	±0.05 V
	0.4:1	±0.1 V
	2:1	±0.5 V
	4:1	±1 V
	20:1	±5 V
	40:1	±10 V
	120:1	±30 V
Offset compensation range	in all attenuation settings applicable	±30 V
Offset compensation error		$\pm(0.35\% \times \text{offset} + 0.35\% \times \text{input voltage range})$ (meas.)
Operating voltage window	each signal socket to ground, not handheld, with 1 m protective distance to probe head	±60 kV
	handheld in combination with R&S®ZISO-Zxxx (excl. R&S®ZISO-Z301)	1000 V (RMS) CAT III
	handheld in combination with R&S®ZISO-Z301	300 V CAT II

System noise voltage (meas.)					
measured with compatible Rohde & Schwarz oscilloscope (system noise is depending on oscilloscope frontend)					
Input voltage range	R&S®ZISO-B901 (100 MHz)	R&S®ZISO-B902 (200 MHz)	R&S®ZISO-B903 (350 MHz)	R&S®ZISO-B905 (500 MHz)	R&S®ZISO-B910 (1 GHz)
±0.01 V	107 µV	121 µV	153 µV	172 µV	245 µV
±0.025 V	140 µV	161 µV	220 µV	252 µV	383 µV
±0.05 V	211 µV	255 µV	363 µV	417 µV	623 µV
±0.1 V	382 µV	465 µV	683 µV	780 mV	1.16 mV
±0.5 V	1.84 mV	2.26 mV	3.35 mV	3.81 mV	5.65 mV
±1 V	5.90 mV	7.27 mV	9.49 mV	10.9 mV	16.0 mV
±5 V	18.9 mV	23.5 mV	34.3 mV	39.0 mV	58.5 mV
±10 V	37.0 mV	45.7 mV	67.4 mV	77.1 mV	115 mV
±30 V	110 mV	134 mV	201 mV	229 mV	342 mV

Maximum rated input voltage		
Continuous voltage	derated, refer to manual, input inner and outer conductor to ground with R&S®ZISO-Zxxx (excl. R&S®ZISO-Z301)	1000 V (RMS) CAT III
	derated, refer to manual, input inner and outer conductor to ground with R&S®ZISO-Z301	300 V (RMS) CAT III
	derated, see figure below, input inner conductor to reference terminal without R&S®ZISO-Zxxx	30 V (RMS)

Maximum rated sine-wave root mean square voltage between probe input and probe reference terminal versus frequency

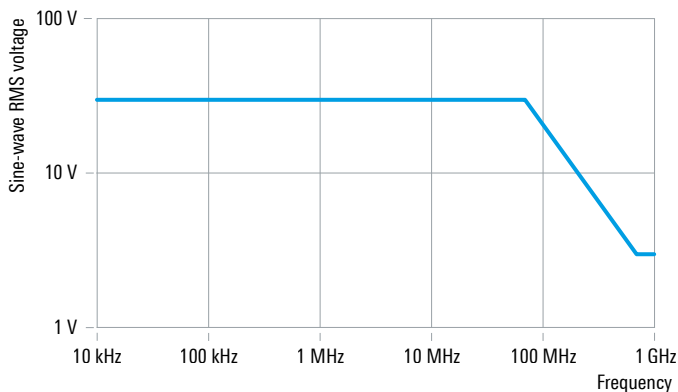

Base unit		
Input coupling	DC	50 Ω

R&S®ProbeMeter

Specifications for measurement error apply only when offset compensation setting is 0 V. The R&S®ProbeMeter can be used to measure differential and common mode voltages.

Measurement error

DC coupling (meas.)	probe head only and with R&S®ZISO-Zxxx (excl. R&S®ZISO-Z302)	
	+15°C to +35°C	±0.2% of reading ±0.01 V × tip attenuation
	0°C to +40°C	±0.4% of reading ±0.02 V × tip attenuation
	with R&S®ZISO-Z302	
AC coupling (meas.)	+15°C to +35°C	±0.8% of reading ±0.01 V × tip attenuation
	0°C to +40°C	±1.6% of reading ±0.02 V × tip attenuation
	with R&S®ZISO-Z302	
	+15°C to +35°C	±0.4% of reading ±0.01 V × tip attenuation
Temperature drift	0°C to +40°C	±1.6% of reading ±0.02 V × tip attenuation
		0.02%/°C of reading ±2 mV/°C (meas.)
50/60 Hz rejection		> 87 dB
Integration time		147 ms

General data

Temperature		
Temperature loading	operating temperature range	0°C to +40°C
	storage temperature range	-40°C to +70°C
Climatic loading		+25°C/+40°C cyclic at 95% relative humidity without condensation, in line with IEC 60068-2-30
Altitude	operation	up to 2000 m
	transport	up to 4500 m
EMC		in line with EMC Directive 2014/30/EC, IEC/EN 61326-1 (table 2), IEC/EN 61326-2-1, CISPR 11/EN 55011(class A)
Calibration interval		2 years
Safety		in line with IEC/EN 61010-1, IEC/EN 61010-031, IEC 60825 1
RoHS		in line with EN IEC 63000
External power supply		100 V to 240 V ±10% at 50/60 Hz, max. 1.0 A or 1.4 A
Mechanical data		
Dimensions	probe head, without connectors and bend protection (W × H × L)	approx. 50 mm × 40 mm × 172 mm (1.97 in × 1.58 in × 6.77 in)
	probe receiver, without connectors and bend protection (W × H × L)	approx. 120 mm × 69 mm × 158 mm (4.72 in × 2.72 in × 6.22 in)
	length of optical fiber cable	
	R&S®ZISO-B403 option	approx. 3 m (10 ft)
	R&S®ZISO-B410 option	approx. 10 m (33 ft)
Weight	probe without accessories	approx. 1.5 kg (3.3 lb)
	probe with standard accessory (incl. bag)	approx. 3.2 kg (7.1 lb)
Probe interface		
Input socket		SMA
Connector	via oscilloscope connector cable	Rohde&Schwarz probe interface
	without oscilloscope connector cable	SMA

R&S®ZISO-Z10x and R&S®ZISO-Z20x probe tip modules

		R&S®ZISO-Z101	R&S®ZISO-Z201	R&S®ZISO-Z202	R&S®ZISO-Z203
Step response					
Rise time	system, 10% to 90%	< 450 ps (meas.)			
Flatness	starting 10 ns after edge	2% (meas.)			
Frequency response					
Bandwidth	system, -3 dB, starting at DC	> 1 GHz (meas.)			
Flatness	1 kHz up to half of the system bandwidth	0.2 dB (meas.)			
Common mode rejection (meas.)	DC	145 dB	145 dB	129 dB	120 dB
	1 MHz	120 dB	105 dB	105 dB	98 dB
	100 MHz	100 dB	85 dB	47 dB	44 dB
	200 MHz	95 dB	80 dB	43 dB	40 dB
	500 MHz	95 dB	75 dB	30 dB	28 dB
	1 GHz	80 dB	60 dB	11 dB	8 dB
Input impedance					
DC input resistance	system	50 Ω ± 1%	10 MΩ ± 1%		40 MΩ ± 1%
Reflection coefficient	system	< -12 dB (meas.)	3.7 pF (meas.)	3.5 pF (meas.)	3.2 pF (meas.)
DC characteristics					
Attenuation	system	1.5:1	10:1	25:1	100:1
Attenuation error	system	±2%			
Maximum rated input voltage					
Continuous voltage	between probe tip and probe reference terminal	8 V (RMS)	300 V (RMS)	750 V (RMS)	2500 V (RMS)
	between probe terminals and earth ground; derated	1000 V (RMS) CAT III			
Transient voltage		±45 V (peak)	±500 V (peak) ¹⁾	±1000 V (peak) ¹⁾	±3500 V (peak) ¹⁾
Dynamic range					
Input voltage range		±45 V	±300 V	±750 V	±3000 V

General data

Temperature			
Temperature loading	operating temperature range	0°C to +40°C	
Climatic loading		+25°C/+40°C cyclic at 95% relative humidity without condensation, in line with IEC 60068-2-30	
Altitude	operation	up to 2000 m	
Safety		in line with Low Voltage Directive 2014/35/EU, IEC 61010-1, IEC 61010-031, IEC 60825	
RoHS		in line with EN IEC 63000	
Mechanical data			
Dimensions	diameter of probe tip	approx. 5 mm (0.2 in)	
	cable length	R&S®ZISO-Z201	approx. 21.5 cm (8.5 in)
		R&S®ZISO-Z202	approx. 32 cm (12.6 in)
		R&S®ZISO-Z203	approx. 38 cm (15 in)
Weight	probe only	approx. 75 g (0.17 lb)	
Probe input			
Connector	R&S®ZISO-Z201	MMCX	
	R&S®ZISO-Z202	SQPIN (2.54 mm (0.1 in))	
	R&S®ZISO-Z203	WSQPIN (5.08 mm (0.2 in))	

¹⁾ Between probe tip and reference terminal.

R&S® ZISO-Z30x probe tip modules

		R&S® ZISO-Z301	R&S® ZISO-Z302
Step response			
Rise time	system, 10% to 90%	700 ps (meas.)	900 ps (meas.)
Flatness	starting 10 ns after edge	2% (meas.)	
Frequency response			
Bandwidth	system, -3 dB, starting at DC	> 500 MHz (meas.)	
Input impedance			
DC input resistance	system	10 Ω ± 1%	100 MΩ ± 1%
Input capacitance	system	11 pF (meas.)	4.6 pF (meas.)
DC characteristics			
Attenuation	system	10:1	100:1
Attenuation error	system	±2%	
Maximum rated input voltage			
Continuous voltage	between probe tip and probe reference terminal derated	300 V (RMS)	3540 V (RMS)
	between probe terminals and earth ground derated	300 V (RMS) CAT III	1000 V (RMS) CAT III
Transient voltage		±45 V (peak)	±500 V (peak) ²⁾
Dynamic range			
Input voltage range		±300 V	

General data

Temperature			
Temperature loading	operating temperature range	0°C to +40°C	
Climatic loading		+25°C/+40°C cyclic at 95% relative humidity without condensation, in line with IEC 60068-2-30	
Altitude	operation	up to 2000 m	
Safety		in line with Low Voltage Directive 2014/35/EU, IEC 61010-1, IEC 61010-031, IEC 60825	
RoHS		in line with EN IEC 63000	
Mechanical data			
Dimensions	diameter of probe tip	approx. 5 mm (0.2 in)	
	diameter of reference terminal	approx. 2 mm (0.08 in)	
	cable length	approx. 1.2 m (47 in)	
Weight	probe only	approx. 75 g (0.17 lb)	
Probe input			
Connector		browser	

²⁾ Between probe tip and reference terminal.

ORDERING INFORMATION

Designation	Type	Order No.
Probe configuration, base model		
Isolated probing system, ± 30 V, 1 kV (RMS) CAT III (depending on tip module), Rohde & Schwarz probe interface and BNC Incl. carrying case; operating manual	R&S®RT-ZISO	1804.5000K02
Choose your cable length		
3 m optical fiber cable	R&S®ZISO-B404	1804.5017.02
10 m optical fiber cable	R&S®ZISO-B410	1804.5023.02
Choose your system bandwidth		
100 MHz option	R&S®ZISO-B901	1804.5030.02
200 MHz option	R&S®ZISO-B902	1804.5046.02
350 MHz option	R&S®ZISO-B903	1804.5052.02
500 MHz option	R&S®ZISO-B905	1804.5069.02
1 GHz option	R&S®ZISO-B910	1804.5075.02
Choose your probe tips		
MMCX 1.5x 50 Ω , tip module for R&S®RT-ZISO, 8 V (RMS), ± 45 V (peak), 1 kV (RMS) CAT III	R&S®ZISO-Z101	1803.4100.02
MMCX 10x 10 M Ω , tip module for R&S®RT-ZISO, ± 300 V (peak), 1 kV (RMS) CAT III	R&S®ZISO-Z201	1803.4200.02
SQPIN 25x 10 M Ω , tip module for R&S®RT-ZISO, ± 750 V (peak), 1 kV (RMS) CAT III	R&S®ZISO-Z202	1803.4300.02
WSQPIN 100x 40 M Ω , tip module for R&S®RT-ZISO, ± 3 kV (peak), 1 kV (RMS) CAT III	R&S®ZISO-Z203	1803.4400.02
Browser 10x 10 M Ω , tip module for R&S®RT-ZISO, ± 300 V (peak), 300 V (RMS) CAT III	R&S®ZISO-Z301	1803.4500.02
Browser 100x 100 M Ω , tip module for R&S®RT-ZISO, ± 3 kV (peak), 1 kV (RMS) CAT III	R&S®ZISO-Z302	1803.4600.02
Bandwidth upgrade		
200 MHz upgrade	R&S®ZISO-B202	1804.5146.02
350 MHz upgrade	R&S®ZISO-B203	1804.5152.02
500 MHz upgrade	R&S®ZISO-B205	1804.5169.02
1 GHz upgrade	R&S®ZISO-B210	1804.5175.02

Pre-package model with isolated probes

Type	Consists of:	Order No.
R&S®RT-ZISO01	100 MHz isolated probe package with 3 m length, includes R&S®ZISO-Z301 probe tip	1804.5000P11
R&S®RT-ZISO01L	100 MHz isolated probe package with 10 m length, includes R&S®ZISO-Z301 probe tip	1804.5000P21
R&S®RT-ZISO02	200 MHz isolated probe package with 3 m length, includes R&S®ZISO-Z301 probe tip	1804.5000P12
R&S®RT-ZISO02L	200 MHz isolated probe package with 10 m length, includes R&S®ZISO-Z301 probe tip	1804.5000P22
R&S®RT-ZISO03	350 MHz isolated probe package with 3 m length, includes R&S®ZISO-Z301 probe tip	1804.5000P13
R&S®RT-ZISO03L	350 MHz isolated probe package with 10 m length, includes R&S®ZISO-Z301 probe tip	1804.5000P23
R&S®RT-ZISO05	500 MHz isolated probe package with 3 m length, includes R&S®ZISO-Z301 probe tip	1804.5000P14
R&S®RT-ZISO05L	500 MHz isolated probe package with 10 m length, includes R&S®ZISO-Z301 probe tip	1804.5000P24
R&S®RT-ZISO10	1 GHz isolated probe package with 3 m length, includes R&S®ZISO-Z201 and R&S®ZISO-Z301 probe tips	1804.5000P15
R&S®RT-ZISO10L	1 GHz isolated probe package with 10 m length, includes R&S®ZISO-Z201 and R&S®ZISO-Z301 probe tips	1804.5000P25

Service at Rohde & Schwarz

YOU'RE IN GREAT HANDS

	SERVICE PLANS	ON DEMAND
Calibration	Up to five years ¹⁾	Pay per calibration
Warranty and repair	Up to five years ¹⁾	Standard price repair

¹⁾ For extended periods, contact your Rohde & Schwarz sales office.

Instrument management made easy

The R&S®InstrumentManager makes it easy to register and manage your instruments. It lets you schedule calibration dates and book services.

Find out more
about our service
portfolio under:



FROM PRESALES TO SERVICE. AT YOUR DOORSTEP.

The Rohde & Schwarz network in over 70 countries ensures optimum on-site support by highly qualified experts.

User risks are reduced to a minimum at all project stages:

- ▶ Solution finding/purchase
- ▶ Technical startup/application development/integration
- ▶ Training
- ▶ Operation/calibration/repair



Service at Rohde & Schwarz
You're in great hands

- ▶ Worldwide
- ▶ Local and personalized
- ▶ Customized and flexible
- ▶ Uncompromising quality
- ▶ Long-term dependability



dataTec

Mess- und Prüftechnik. Die Experten.

**Ihr Ansprechpartner /
Your Partner:**

dataTec AG

E-Mail: info@datatec.eu

>>> www.datatec.eu

Rohde & Schwarz

The Rohde&Schwarz technology group is among the trail-blazers when it comes to paving the way for a safer and connected world with its leading solutions in test & measurement, technology systems and networks & cybersecurity. Founded 90 years ago, the group is a reliable partner for industry and government customers around the globe. The independent company is headquartered in Munich, Germany and has an extensive sales and service network with locations in more than 70 countries.

www.rohde-schwarz.com

Sustainable product design

- ▶ Environmental compatibility and eco-footprint
- ▶ Energy efficiency and low emissions
- ▶ Longevity and optimized total cost of ownership

Certified Quality Management

ISO 9001

Certified Environmental Management

ISO 14001

Rohde & Schwarz training

www.training.rohde-schwarz.com

Rohde & Schwarz customer support

www.rohde-schwarz.com/support

