

dataTec

Mess- und Prüftechnik. Die Experten.

**Ihr Ansprechpartner /
Your Partner:**

dataTec AG
E-Mail: info@datatec.eu
>>> www.datatec.eu



Authorized
Distributor



Product Brochure

PXI Express Chassis

Contents

[PXI Express Chassis](#)

[Detailed View](#)

[Key Features](#)

[Software](#)

[Supporting Documentation](#)

[Configure a Custom NI System](#)

[What is PXI?](#)

[PXI Instrumentation](#)

[Hardware Services](#)

PXI Express Chassis

[PXIe-1071](#), [PXIe-1073](#), [PXIe-1082DC](#), [PXIe-1083](#), [PXIe-1084](#), [PXIe-1085](#), [PXIe-1086](#), [PXIe-1086DC](#), [PXIe-1088](#), [PXIe-1090](#), [PXIe-1092](#), [PXIe-1095](#)



FIGURE 1

NI offers large and small PXIe chassis to accommodate a wide variety of requirements.

- Performance—up to 24 GB/s system bandwidth and 8 GB/s per-slot dedicated bandwidth
- Breadth of size options from 2 to 18 slots
- Hybrid slots for instrumentation flexibility; compatibility with PXI, PXI Express, CompactPCI, and CompactPCI Express modules
- Up to 82 W per slot of power and cooling for more advanced I/O modules
- High-reliability options with redundant power supplies and fans
- System monitoring features for voltage rails, temperature, and fan speed

Built for Automated Test and Measurement

NI provides a PXI Express chassis portfolio with a wide breadth of size and performance options and with additional features beyond those required in the PXI specification that are designed to simplify system interaction and usability. PXI Express chassis incorporate high-bandwidth backplanes with PCI Express data bus communication. Additionally, each chassis includes a 10 MHz and 100 MHz reference clock and trigger bus, with select chassis including a timing slot for higher stability and multichassis timing and synchronization capabilities.

Table 1. NI offers PXI Express chassis ranging from 2 to 18 slots and up to 24 GB/s of system bandwidth.

	<u>PXIe-1071</u>	<u>PXIe-1073</u>	<u>PXIe-1082DC</u>	<u>PXIe-1083</u>	<u>PXIe-1084</u>	<u>PXIe-1085</u>	<u>PXIe-1086</u>		<u>PXIe-1088</u>	<u>PXIe-1090</u>	<u>PXIe-1092</u>	<u>PXIe-1095</u>		
Total Slots	4	5	8	5	18	18	18		9	2	10	18		
Hybrid Slots	3	3	4	5	17	16	16		8	1	7	5		
PXI Express Slots	0	2	3	0	0	1	1		0	1	0	11		
System Timing Slot	—	—	●	—	—	●	●		—	—	●	●		
Chassis Power Supply Type	AC	AC	DC	AC	AC	AC	DC	AC	AC	AC	AC	AC		
Maximum System Bandwidth	3 GB/s	250 MB/s	8 GB/s	2 GB/s	4 GB/s	24 GB/s	12 GB/s		8 GB/s	2 GB/s	24 GB/s	24 GB/s		
Slot Cooling Capacity	38 W	38 W	38 W	58 W	58 W	38 W	38 W		58 W	58 W	82 W	82 W		
Redundant Hardware Option	—	—	—	—	—	—	●		—	—	—	●		
Onboard Clock Upgrade ¹	—	—	—	—	—	—	—		—	—	—	●	●	—
External Clocking ¹	—	—	●	—	●	—	●		—	●	—	●	●	—
External Trigger Access ¹	—	—	—	—	●	—	—		—	—	—	●	●	—

¹These features are timing and synchronization upgrades. The onboard clock upgrade includes an oven-controlled crystal oscillator (OCXO) instead of the standard VCXO, which has higher frequency stability. The main source of frequency error in reference oscillators is temperature variation. An OCXO minimizes this error by housing the crystal oscillator circuit inside a sealed oven, which is maintained at a constant temperature higher than the ambient temperature external to the OCXO. This results in a reference oscillator that is several orders of magnitude more stable and accurate than regular crystal oscillators.

Detailed View

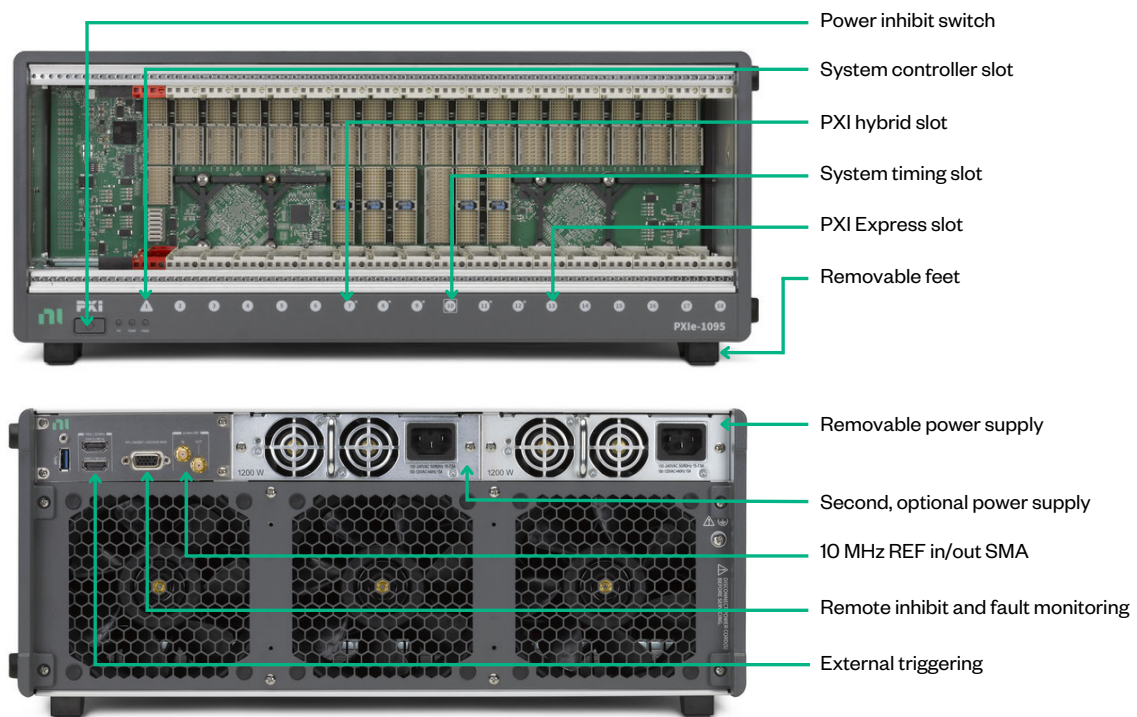

FIGURE 2
Breakdown of the PXI Express Chassis Architecture

Key Features

Timing and Synchronization Quality

A key advantage of a PXI system is the integrated timing and synchronization capabilities. An NI PXI Express chassis incorporates a dedicated 10 MHz system reference clock, PXI trigger bus, star trigger bus, and slot-to-slot local bus, as well as a 100 MHz differential system clock, differential signaling, and differential star triggers to address the need for advanced timing and synchronization.

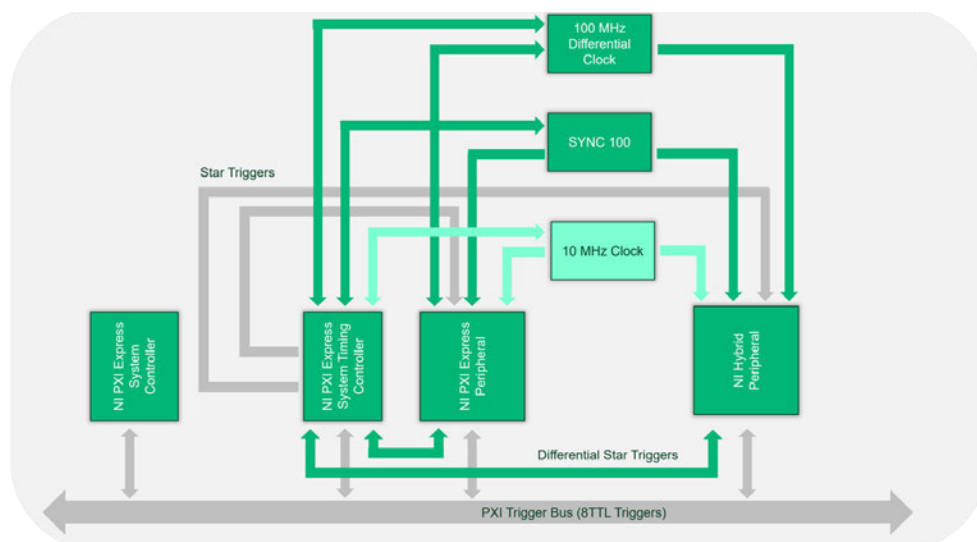

FIGURE 3
PXI Express Backplane Signal Routing Diagram

The phase noise and stability of the backplane system reference clocks are important characteristics of the PXI chassis because they indicate how reliably you can expect to synchronize modules within the system. Given the choice of components and backplane design, the PXI Express 100 MHz differential system clock on NI PXI Express chassis features phase noise performance that is orders of magnitude better than other vendors' chassis in the same class.

You can phase lock loop (PLL) the 10 MHz and 100 MHz system reference clocks to a higher stability clock source than the one on the chassis backplane. This helps higher-sample-rate PXI modules to better align their samples across multiple instruments. The PLL circuitry of the NI PXI chassis is designed to suppress more noise when locking to an external reference, thus permitting cleaner transmission of the higher stability clock source. With other vendors' chassis, depending on the system clock source phase noise required by the application, you may need to phase lock the external reference clock to each module individually rather than at a system level to the chassis backplane, which increases system complexity and cost.

10 MHz REF Clock Connectors

When the 10 MHz REF IN connector on NI PXI Express chassis detects a signal, the backplane automatically phase locks the PXI_CLK10, PXIe_CLK100, and PXIe_SYNC100 signals to this external clock and distributes these signals to the peripheral slots for synchronization. Additionally, you can use the 10 MHz REF OUT connector to route the backplane's PXI_CLK10 to another chassis for synchronization, or you can insert a timing and synchronization module (for example, the [PXIe-6674T](#)) in the system timing slot to drive the PXI_CLK10 of the chassis with a higher stability clock. The 10 MHz REF connectors on the PXIe-1095, PXIe-1092, and PXIe-1084 are included on the rear of the chassis as part of their timing and synchronization upgrade options.

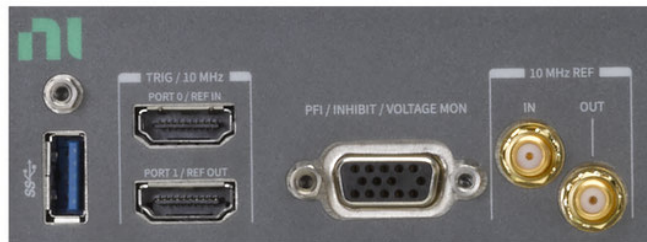

FIGURE 4

10 MHz REF IN and OUT SMA Connectors on the PXIe-1095 Chassis for Multichassis Synchronization

Cooling

NI chassis are designed and validated to meet or exceed the cooling requirements for the most power-demanding PXI modules. The PXI Express power specification requires a minimum of 30 W of power be available to each peripheral slot and that each slot dissipates that same amount of heat.

PXI Express chassis designed by NI exceed PXI Express requirements by providing at least 38.25 W of power and cooling to every peripheral slot; some chassis push slot cooling capacity even further by providing 58 W or 82 W of cooling to a single slot. This extra power and cooling make advanced capabilities of high-performance modules, such as digitizers and high-speed digital I/O and RF modules, possible in applications that may require continuous acquisition or high-speed testing. Chassis vary in total system power, so it is always recommended to perform a system-level power budget when configuring a new system.

To mitigate electrical noise from moving mechanical features within the chassis, such as cooling fans, many NI chassis place the cooling fans at the rear of the chassis. To reduce noise even further, some NI chassis implement a dedicated 12 V power supply to power the chassis cooling fans, system controller slot, and, in some cases, the power supply fans. This helps prevent coupling noise from these components from seeping into the rails powering the measurement modules.

Acoustics

The PXIe-1090, PXIe-1092, and PXIe-1095 are some of NI's quietest chassis in the typical 38 W cooling profiles, with sound pressure levels in the range of only 32 dBA to 38 dBA, more than 2X quieter than other vendors' large chassis. Accounting for fan speed control, the type of fan used, and fan-mounting method makes cooling optimization possible while minimizing the acoustic noise emitted. NI implements pulse-width modulated (PWM) fans in many of its PXI chassis to reduce acoustic emissions further than traditional voltage-controlled fans do. PWM signal control of the fan permits the NI chassis designer to use a wider range of the fan's RPM settings, thus making it possible to fine-tune the chassis' acoustic emissions and cooling performance.

2-Slot and MXIe Chassis

The PXIe-1090 is the smallest and most affordable chassis NI has ever produced. Like the PXIe-1083, it uses MXIe over Thunderbolt™ rather than PCIe. The PXIe-1090 is an affordable option for those who wish to purchase only one or two instruments without the customization that comes with buying a controller and chassis separately. With 58 W of cooling capability per slot, 2 GB/s of streaming bandwidth, and one of the best acoustic emissions profiles on the market, the PXIe-1090 is a compact yet powerful chassis that will make a great addition to any benchtop.



FIGURE 5
The 2-Slot PXIe-1090 Chassis

All-Hybrid Slot Options

For maximum instrument placement flexibility, you can insert both PXI Express and hybrid-compatible PXI modules in the PXIe-1084 chassis because all 17 peripheral slots are hybrid slots. As shown in Table 1, all NI PXI Express chassis feature at least a few hybrid slots, but some are more optimized for this use case than others.



FIGURE 6
The PXIe-1084 features 17 hybrid peripheral slots.

Power Supplies

The instrument-grade power supplies implemented in NI PXI chassis are optimized to meet the unique power requirements of PXI as opposed to ATX power supplies, which are designed for general use in PCs. They are custom-designed for NI chassis to meet and exceed the PXI specification minimum power requirements. With these power supplies, NI PXI Express chassis can deliver at least 38.25 W to a peripheral module. Some chassis such as the PXIe-1095 and PXIe-1092 can deliver 82 W of power to all modules in a filled chassis. NI PXI chassis can provide the minimum power requirement over the entire specified operating temperature range (0 °C to 50/55 °C) with no power derating (refer to product manuals for operating temperature ranges for specific NI PXI chassis models).

Reliability and Uptime

Some NI PXI chassis are designed specifically for maximizing uptime and system availability, resulting in a low mean time to repair (MTTR). Instrumentation power supply failures are costly for most automated test systems. You can easily access, remove, and replace PXIe-1095 power supplies, for instance, directly from the rear of the chassis to avoid de-racking the chassis or removing I/O connections.



FIGURE 7

PXIe-1095 power supplies are easily replaceable from the rear of the chassis.

Monitoring Features

Several chassis variants include terminals for remotely powering on or off the chassis or monitoring overall chassis health for any detected faults. Most NI chassis also feature remote sensing of the output voltage on the backplane power rails to compensate for voltage drops. This design feature is important for PXI Express chassis particularly for applications with high-power modules because it provides better regulation at the backplane when there are large load swings.

For local monitoring, NI chassis feature several internal sensors that check individual voltage rails, fan speed, and temperature. The current value of these sensors can be displayed in NI Measurement & Automation Explorer (NI MAX) or can be programmatically accessed through the System Configuration API to ensure stable operating conditions. With these temperature readings, for instance, you can pinpoint the operating temperatures of your system and instruments for troubleshooting purposes. You also can use some temperature readings in the fan speed algorithm of the chassis.

The System Configuration API gathers information about devices on both local and remote systems. You can use the System Configuration API to programmatically reboot a system, save and load system images, install and uninstall software, and obtain information about a system like current temperature, fan speed, or calibration dates. You can find the System Configuration palette on the functions subpalette in NI LabVIEW within the Measurement I/O palette.

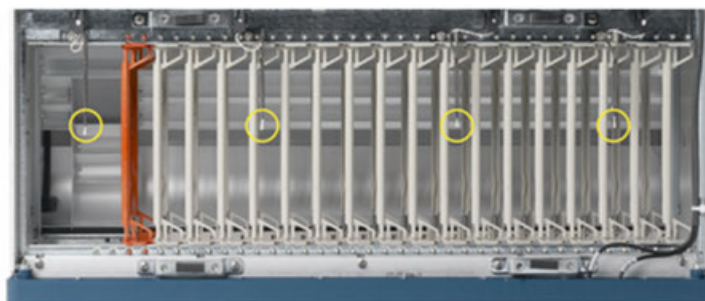

FIGURE 8

The top casing of this PXIe-1085 chassis is removed to show four outlet air temperature sensors (the front of the chassis is at the bottom of the image).

Voltage Sensors					
Name	3.3V Backplane	5V Backplane	12V Backplane	-12V Backplane	5V Aux
Reading	3.29V	5.00V	12.02V	-11.93V	5.04V

Temperature Sensors						
Name	Rear Intake	Side Intake	Exhaust 1	Exhaust 2	Exhaust 3	Exhaust 4
Reading	29°C	26°C	36°C	37°C	30°C	28°C

Fans				
Mode	Auto			
Cooling Profile	38W			
Name	Side	PXI Module Fan 1	PXI Module Fan 2	PXI Module Fan 3
Reading	2000 RPM	1500 RPM	1530 RPM	1510 RPM

Power Supplies		
Redundant	No	
Name	Power Supply 1	Power Supply 2
State	Not Present	On
Maximum Power	Unknown	1200W
Intake Temperature	Unknown	33°C

FIGURE 9 PXIe-1095 Chassis Sensors for Voltage Rails, Temperature, Fan Speed, and Power Supply Temperature in NI MAX

Peer-to-Peer Streaming

Processing-intensive applications such as prototyping 5G wireless communications or performing real-time spectrum analysis (RTSA) warrant the addition of inline, user-defined FPGA processing. NI PXI Express chassis and software enable peer-to-peer communication from a modular instrument to an FPGA module for inline signal processing that bypasses the PXI embedded controller. For more information, see NI's white paper, "[Streaming Architecture of the Industry's Highest Performance PXI Express Platform.](#)"

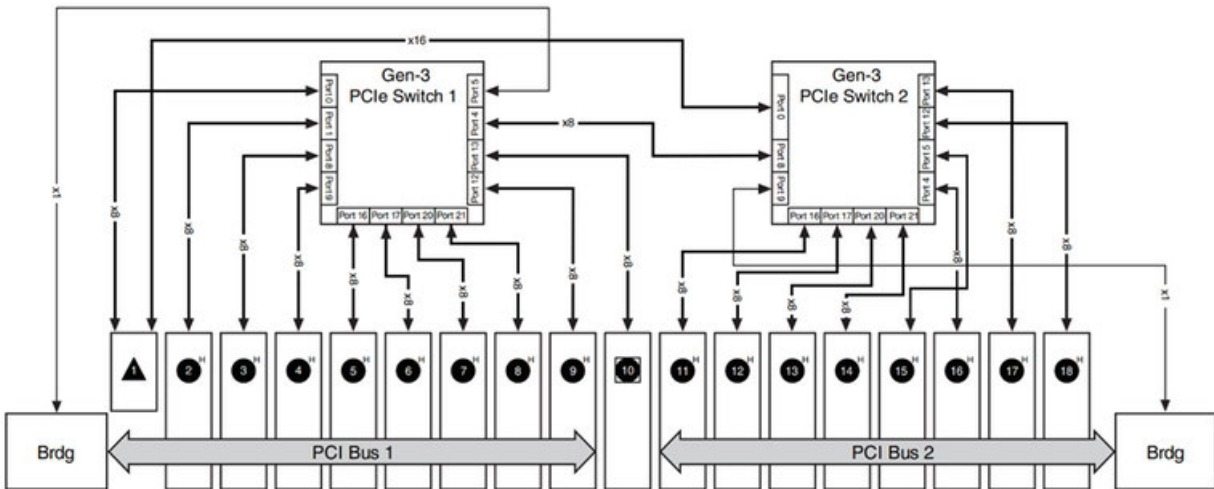

FIGURE 10 The PXIe-1085 24 GB/s chassis provides 8 GB/s peer-to-peer streaming bandwidth.

Software

NI MAX—Configuration and Monitoring

The PXI Platform Services software included with your chassis automatically identifies your PXI Express system components to generate a pxiesys.ini file. You can configure your entire PXI system and identify PXI chassis through NI MAX, included with your system controller. This software creates the pxiesys.ini and pxisys.ini files that define your PXI system parameters. It also provides an interface to route and reserve triggers so dynamic routing, through drivers such as NI-DAQmx, avoids double-driving and potentially damaging trigger lines. This is shown in Figure 10. For more information about routing and reserving PXI triggers, refer to NI's white paper, [“Using PXI and Timing and Triggering Functionality.”](#) The configuration steps for single-chassis or multichassis systems are the same.

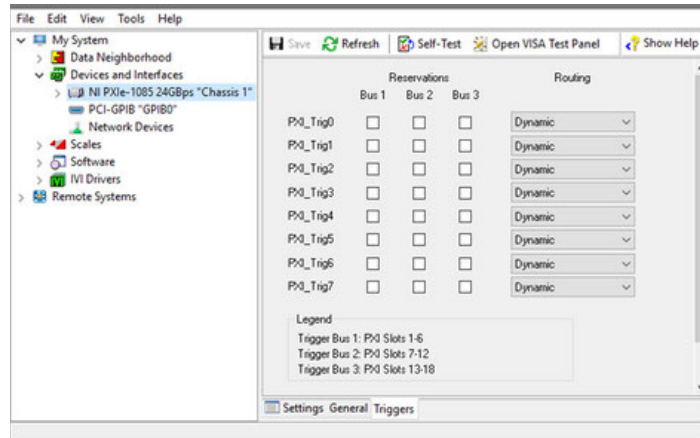
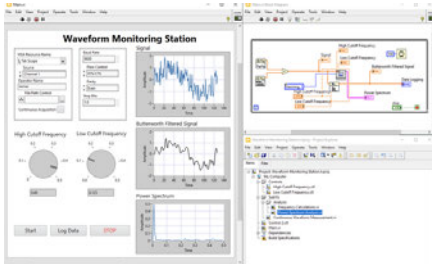

FIGURE 11
Route and reserve triggers for your chassis in NI MAX.

NI Software-The Right Tool for the Job

NI has a variety of software for engineers working on research, validation, and production test applications. Learn about our software that helps engineers perform quick ad-hoc tests, build an automated test system, automate data analysis and reporting, develop test sequences, and more.

LabVIEW



Graphical programming environment that engineers use to develop automated research, validation, and production test systems.

- Acquire data from NI and third-party hardware and communicate using industry protocols
- Use configurable, interactive display elements
- Take advantage of available analysis functions

DIAdem

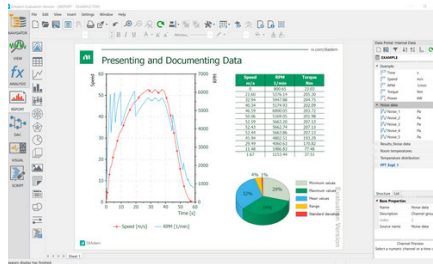

Data analytics software for measurement data search, inspection, analysis, and automated reporting.

- Display data in multiple 2D-axis systems
- Perform calculations with a simple point-and-click interface
- Automate your measurement data analysis workflow, from import to analysis

TestStand

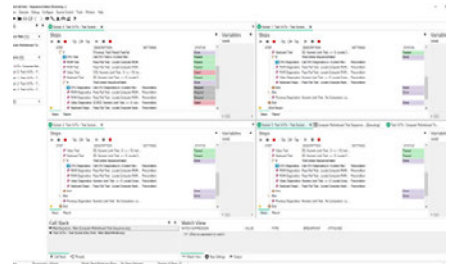

Test executive software that accelerates system development for engineers in validation and production.

- Call and execute tests in LabVIEW, Python, C/C++, or .NET
- Conduct complex tasks, such as parallel testing
- Create customer operator interfaces and robust tools for deployment and debugging

G Web

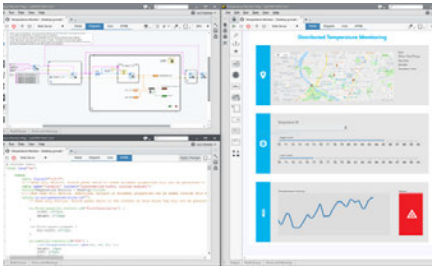

Development software that helps engineers create web-based user interfaces without the need for traditional web development skills.

- Data transfer APIs for connecting to systems written in LabVIEW, Python, or C#
- Pre-built objects for data display and user input
- Included hosting on SystemLink™ Cloud

FlexLogger™

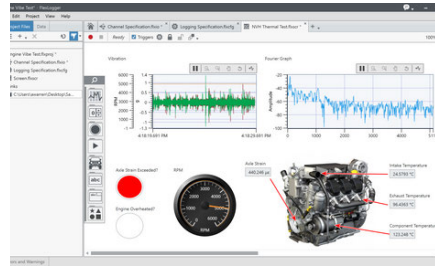

No-code data acquisition software engineers use to build validation and verification test applications.

- Interactive visualization tools for monitoring tests with drag-and-drop charts, graphs, and controls
- Ability to set alarms that monitor single channels or groups for unexpected behavior

InstrumentStudio™



Application software that simplifies setup and configuration of NI PXI hardware

- Customizable layouts for monitoring multiple instruments at once
- Interactively debug in tandem with code
- TDMS file export containing instrument settings, measurements, and raw data

Supporting Documentation

Table 2. PXI Chassis Documentation

Document Type	Model
Getting Started Guide	PXIe-1071 , PXIe-1073 , PXIe-1082DC , PXIe-1083 , PXIe-1084 , PXIe-1085 , PXIe-1086 , PXIe-1086DC , PXIe-1088 , PXIe-1090 , PXIe-1092 , PXIe-1095
Specifications	PXIe-1071 , PXIe-1073 , PXIe-1082DC , PXIe-1083 , PXIe-1084 , PXIe-1085 , PXIe-1086 , PXIe-1086DC , PXIe-1088 , PXIe-1090 , PXIe-1092 , PXIe-1095

Configure a Custom NI System

NI's online system advisors help you create a custom system based on your specific requirements. Use the advisor to choose compatible hardware, software, accessories, and services and then save your selections as configurations for easy quoting and purchasing later. Visit ni.com/advisor to learn more.

What Is PXI?



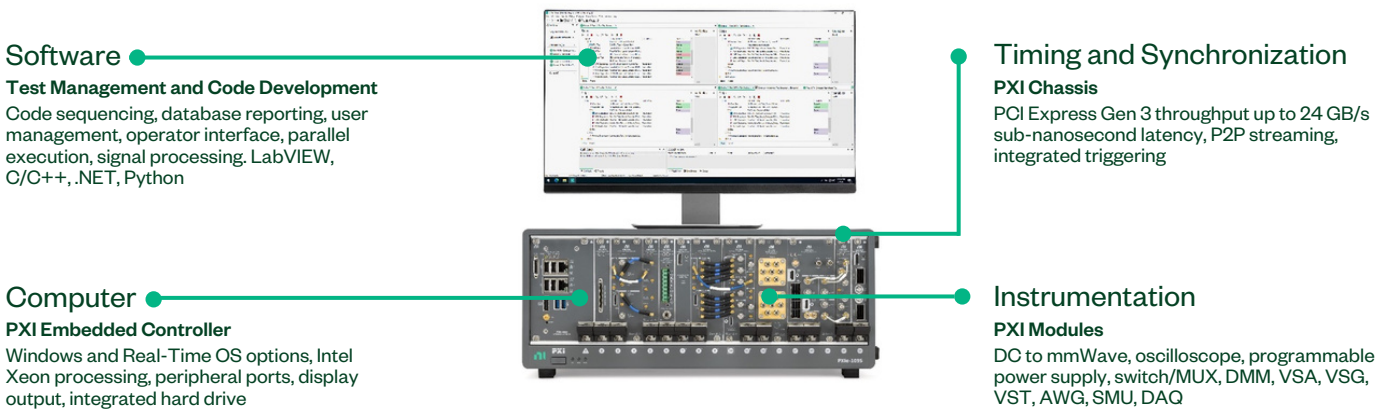

A Platform Approach to Test and Measurement

Powered by software, PXI is a rugged PC-based platform for measurement and automation systems. PXI combines PCI electrical-bus features with the modular, Eurocard packaging of CompactPCI and then adds specialized synchronization buses and key software features. PXI is both a high-performance and low-cost deployment platform for applications such as manufacturing test, military and aerospace, machine monitoring, automotive, and industrial test. Developed in 1997 and launched in 1998, PXI is an open industry standard governed by the PXI Systems Alliance (PXISA), a group of more than 70 companies chartered to promote the PXI standard, ensure interoperability, and maintain the PXI specification.



Integrated with the Latest Commercial Technology

By leveraging the latest commercial technology for our products, we can continually deliver high performance and high-quality products to our users at a competitive price. The latest PCI Express Gen 3 switches deliver higher data throughput, the latest Intel multicore processors facilitate faster and more efficient parallel (multisite) testing, the latest FPGAs from Xilinx help to push signal processing algorithms to the edge to accelerate measurements, and the latest data converters from TI and ADI continually increase the measurement range and performance of our instrumentation.

HIGHER DATA THROUGHPUT  PCI Express Gen 3	PARALLEL TEST EXECUTION  Multicore Processors	MEASUREMENT ACCELERATION  FPGAs	INCREASED MEASUREMENT RANGE  Data Converters
--	--	---	---

PXI Instrumentation

NI offers more than 600 different PXI modules ranging from DC to mmWave. Because PXI is an open industry standard, nearly 1,500 products are available from more than 70 different instrument vendors. With standard processing and control functions designated to a controller, PXI instruments need to contain only the actual instrumentation circuitry, which provides effective performance in a small footprint. Combined with a chassis and controller, PXI systems feature high-throughput data movement using PCI Express bus interfaces and sub-nanosecond synchronization with integrated timing and triggering.



Oscilloscopes

Sample at speeds up to 12.5 GS/s with 5 GHz of analog bandwidth, featuring numerous triggering modes and deep onboard memory



Digital Multimeters

Perform voltage (up to 1000 V), current (up to 3A), resistance, inductance, capacitance, and frequency/period measurements, as well as diode tests



Digital Instruments

Perform characterization and production test of semiconductor devices with timing sets and per channel pin parametric measurement unit (PPMU)



Waveform Generators

Generate standard functions including sine, square, triangle, and ramp as well as user-defined, arbitrary waveforms



Frequency Counters

Perform counter timer tasks such as event counting and encoder position, period, pulse, and frequency measurements



Source Measure Units

Combine high-precision source and measure capability with high channel density, deterministic hardware sequencing, and SourceAdapt transient optimization



Power Supplies & Loads

Supply programmable DC power, with some modules including isolated channels, output disconnect functionality, and remote sense



FlexRIO Custom Instruments & Processing

Provide high-performance I/O and powerful FPGAs for applications that require more than standard instruments can offer



Switches (Matrix & MUX)

Feature a variety of relay types and row/column configurations to simplify wiring in automated test systems



Vector Signal Transceivers

Combine a vector signal generator and vector signal analyzer with FPGA-based, real-time signal processing and control



GPIB, Serial, & Ethernet

Integrate non-PXI instruments into a PXI system through various instrument control interfaces



Data Acquisition Modules

Provide a mix of analog I/O, digital I/O, counter/timer, and trigger functionality for measuring electrical or physical phenomena

NI Hardware Services

All NI hardware includes a one-year warranty for basic repair coverage and calibration in adherence to NI specifications prior to shipment. PXI systems also include basic assembly and a functional test. NI offers additional entitlements to improve uptime and lower maintenance costs with service programs for hardware. Learn more at ni.com/services/hardware.

	Hardware	Standard	Premium	Description
Duration at Point of Sale	1 year; included	3 years; optional	3 years; optional	NI enhances warranty coverage with additional service benefits provided with a hardware service program.
Maximum Duration with Renewal	≤3 years with service program	≤3 years	≤3 years	NI maintains the high performance and availability of your hardware for up to three years with a hardware service program.
Extended Repair Coverage	•	•	•	NI restores your device's functionality and includes firmware updates and factory calibration; < 10 working days ⁴ + standard shipping.
System Configuration, Assembly, and Test ¹		•	•	NI technicians assemble, install software in, and test your system per your custom configuration prior to shipment.
Advanced Replacement ²			•	NI stocks replacement hardware that can be shipped immediately if a repair is needed.
System Return Material Authorization (RMA) ¹			•	NI accepts the delivery of fully assembled systems when performing repair services.
Technical Support	•	•	•	NI provides access to support resources for your hardware.
Calibration Plan (Optional)		Standard	Expedited ³	NI performs the requested level of calibration at the specified calibration interval for the duration of the service program.

¹ This option is only available for PXI, CompactRIO, and CompactDAQ systems.

² This option is not available for all products in all countries. Contact your local NI sales engineer to confirm availability.

³ Expedited calibration is only available for the Traceable calibration level.

⁴ This applies to non-RF products only. Standard extended repair coverage for RF products is <15 working days + standard shipping.

PremiumPlus Service Program

NI can customize the offerings listed above or offer additional entitlements such as on-site calibration, custom sparring, and lifecycle services through a [PremiumPlus Service Program](#). Contact your NI sales representative to learn more.

Technical Support

NI hardware service programs and warranty include access to technical support provided by NI support agents during local business hours. Service requests can be managed online. Additionally, take advantage of NI's award-winning [online resources](#) and [communities](#).

©2023 National Instruments Corporation. All rights reserved. National Instruments, NI, and ni.com are trademarks of National Instruments. Other product and company names listed are trademarks or trade names of their respective companies. All rights reserved. National Instruments, NI, and ni.com are trademarks of National Instruments.



Mess- und Prüftechnik. Die Experten.

Ihr Ansprechpartner /
Your Partner:

dataTec AG

E-Mail: info@datatec.eu

>>> www.datatec.eu

