

# FieldFox A-Series Handheld Analyzers

4/6.5/9/14/18/26.5/32/44/50 GHz

- |        |        |        |
|--------|--------|--------|
| N9913A |        |        |
| N9914A |        |        |
| N9915A | N9925A | N9935A |
| N9916A | N9926A | N9936A |
| N9917A | N9927A | N9937A |
| N9918A | N9928A | N9938A |
| N9950A |        | N9960A |
| N9951A |        | N9961A |
| N9952A |        | N9962A |



**dataTec**

Mess- und Prüftechnik. Die Experten.

**Ihr Ansprechpartner /  
Your Partner:**

**dataTec AG**

E-Mail: [info@datatec.eu](mailto:info@datatec.eu)

>>> [www.datatec.eu](http://www.datatec.eu)

**KEYSIGHT**  
Authorized Premium  
Distributor

## Table of Contents

|  |    |
|--|----|
| Definitions.....   | 3  |
| Cable and Antenna Analyzer and Vector Network Analyzer .....                       | 4  |
| Corrected Measurement Uncertainty .....  | 15 |
| TDR Cable Measurements (Option 215) .....  | 22 |
| VNA Time Domain (Option 010) .....   | 23 |
| Mixed-Mode S-Parameters (Option 212).....  | 23 |
| Vector Voltmeter (VVM) (Option 308).....   | 24 |
| Spectrum Analyzer (Option 233 on Combination Analyzers) .....                      | 25 |
| Tracking Generator or Independent Source .....                                     | 35 |
| Real-Time Spectrum Analyzer (RTSA) (Option 350).....                               | 37 |
| I/Q Analyzer (IQA) (Option 351).....   | 38 |
| Noise Figure (NF) (Option 356) .....   | 40 |
| Spectrum Analyzer IF Output.....   | 46 |
| Preamplifier (Option 235).....   | 47 |
| Interference Analyzer and Spectrogram (Option 236).....                            | 47 |
| Channel Scanner (Option 312) .....   | 47 |
| 89600 VSA Software.....  | 47 |
| Over-the-Air (OTA) LTE FDD/TDD (Option 370/371) .....                              | 48 |
| Over-the-Air (OTA) 5GTF (Option 377) .....   | 49 |
| Indoor and Outdoor Mapping (Option 352).....                                       | 51 |
| EMF Measurements (Option 358).....   | 52 |
| AM/FM Analog demodulation, Tune and Listen (Option 355).....                       | 53 |
| Spectrum Analyzer Time Gating (Option 238).....                                    | 54 |
| Reflection Measurements (RL, VSWR) (Option 320, applicable to SA only models)..... | 54 |
| Extended Range Transmission Analysis (ERTA) (Option 209) .....                     | 55 |
| Built-in Power Meter (Option 310).....   | 61 |
| External USB Power Sensor Support (Option 302) .....                               | 62 |
| Pulse Measurements (Option 330) .....  | 62 |
| USB Power Sensor Measurements versus Frequency (Option 208) .....                  | 62 |
| Built-In GPS Receiver (Option 307) .....   | 64 |
| DC Bias Variable-Voltage Source (Option 309).....                                  | 64 |
| Remote Control Capability (Option 030) .....                                       | 65 |
| EMI measurements (Option 361) .....  | 64 |
| General Information .....  | 65 |
| FieldFox Physical Dimensions .....   | 70 |
| Carry Precision With You .....   | 73 |

This data sheet provides the specified and typical performance of the FieldFox family of portable analyzers. This data sheet should be used in conjunction with the technical overviews and configuration guide, for a complete description of the analyzers.

The specifications and measurement capabilities listed in this document require certain options on the FieldFox analyzer. Refer to the FieldFox Configuration Guide to obtain option information. The configuration guide is the main resource for option/measurement capability information (<https://www.keysight.com/us/en/assets/7018-03329/configuration-guides/5990-9836.pdf>).

## Definitions

### Specification (spec)

Specifications include guardbands to account for the expected statistical performance distribution, measurement uncertainties, and changes in performance due to environmental conditions. Specifications are warranted performance. FieldFox must be within its calibration cycle. No warm-up required for the spectrum analyzer specifications listed on pages 25 through 50.

### Typical

Describes additional product performance information not covered by the product warranty. It is performance beyond specifications that 80% of the units exhibit with a 90% confidence level over the temperature range  $23 \pm 5^{\circ}\text{C}$ , unless otherwise noted. Typical performance does not include measurement uncertainty. FieldFox must be within its calibration cycle.

### Nominal

A general, descriptive term or design parameter. It is not tested, and not covered by the product warranty. FieldFox must be within its calibration cycle.

## Cable and Antenna Analyzer and Vector Network Analyzer

The performance listed in this section applies to the cable and antenna analyzer (referred to as CAT) and vector network analyzer (VNA) capabilities available in the following models:

|  |  |
|--|--|
| FieldFox RF & microwave (combination) analyzers: | N9913A, N9914A, N9915A, N9916A, N9917A, N9918A<br>N9950A, N9951A, N9952A |
| FieldFox microwave vector network analyzers:     | N9925A, N9926A, N9927A, N9928A   |

NOTE: Combination analyzers = Cable and antenna tester (CAT) + Vector network analyzer (VNA) + Spectrum analyzer (SA)

### Frequency specifications

|  | Models  | Frequency range    |
|--|---|--------------------|
| N991xA, N992xA                             | N9913A  | 30 kHz to 4 GHz    |
|  | N9913A (with option V5K)                                  | 5 kHz to 4 GHz     |
|  | N9914A  | 30 kHz to 6.5 GHz  |
|  | N9914A (with option V5K)                                  | 5 kHz to 6.5 GHz   |
|  | N9915A, N9925A  | 30 kHz to 9 GHz    |
|  | N9915A (with option V5K)                                  | 5 kHz to 9 GHz     |
|  | N9916A, N9926A  | 30 kHz to 14 GHz   |
|  | N9916A (with option V5K)                                  | 5 kHz to 14 GHz    |
|  | N9917A, N9927A  | 30 kHz to 18 GHz   |
|  | N9917A (with option V5K)                                  | 5 kHz to 18 GHz    |
|  | N9918A, N9928A  | 30 kHz to 26.5 GHz |
|  | N9918A (with option V5K)                                  | 5 kHz to 26.5 GHz  |
| N995xA                                     | N9950A  | 300 kHz to 32 GHz  |
|  | N9951A  | 300 kHz to 44 GHz  |
|  | N9952A  | 300 kHz to 50 GHz  |
| <b>Frequency reference, -10 to 55°C</b>    |   |                    |
| Accuracy                                   | ± 0.7 ppm (spec) + aging                                  |                    |
|  | ± 0.4 ppm (typical) + aging                               |                    |
| Accuracy, when locked to GPS               | ± 0.010 ppm (spec)  |                    |
| Accuracy, when GPS antenna is disconnected | ± 0.2 ppm (nominal) <sup>1</sup>                          |                    |
| Aging Rate                                 | ± 1 ppm/yr for 20 years (spec), will not exceed ± 3.5 ppm |                    |
| <b>Frequency resolution</b>                | <b>Spec</b>   |                    |
| Frequency ≤ 5 GHz                          | 1 Hz  |                    |
| Frequency ≤ 10 GHz                         | 1.34 Hz   |                    |
| Frequency ≤ 20 GHz                         | 2.68 Hz   |                    |
| Frequency ≤ 40 GHz                         | 5.36 Hz   |                    |
| Frequency ≤ 50 GHz                         | 8.04 Hz   |                    |
| <b>Data points or resolution</b>           |   |                    |
|  | 101, 201, 401, 601, 801, 1001, 1601, 4001, 10,001         |                    |

<sup>1</sup> The maximum drift expected in the frequency reference applicable when the ambient temperature changes ± 5°C from the temperature when the GPS signal was last connected.

|   |  |  |
|---|--|--|
| <b>Data points or resolution</b>  |  |  |
| Arbitrary number of points settable through front panel and SCPI                |  |  |
| <b>IF bandwidth<sup>1</sup></b>   | <b>N991xA, N992xA</b>  | <b>N995xA</b>  |
|   | 10 Hz, 30 Hz, 100 Hz, 300 Hz, 1 kHz, 3 kHz,<br>10 kHz, 30 kHz, 100 kHz | 10 Hz, 30 Hz, 100 Hz, 300 Hz, 1 kHz,<br>3 kHz, 10 kHz, 30 kHz, 100 kHz |
| <b>System impedance</b>   |  |  |
| 50 $\Omega$ (nominal), 75 $\Omega$ with appropriate adapter and calibration kit |  |  |

<sup>1</sup> VNA mode only. Recommend using averaging in CAT mode.

## Cable and Antenna Analyzer and Vector Network Analyzer (continued)

### Test port output specifications

**High power** in N991xA and N992xA refers to the target output power level of the analyzer when the *Power Setting* is set to *High*. As an example, if you have a frequency sweep from 3 to 6.5 GHz, the analyzer will achieve the power level of -1 dBm across the band.

**Low power** level for N991xA and N992xA analyzers is a flat -45 dBm across the whole frequency band and is the output of the analyzer when the *Power Setting* is set to *Low*.

**High power** in the N995xA refers to the target output power level of the analyzer when the *Power Setting* is set to *High*. As an example, if you have a frequency sweep from 39 to 46 GHz, the analyzer will achieve the power level of -2 dBm across the band.

**Low power** level for N995xA analyzers is the lowest power level that can be set and is the output of the analyzer when the *Power Setting* is set to *Low*.

**Max leveled power** in the N995xA refers to the maximum leveled (flattened) power that can be achieved across the designated frequency range. For example, if you have a frequency sweep from 32 to 44 GHz and set up the analyzer to measure all four S-parameters, needing both ports 1 and 2, the maximum power the analyzer can be set to is -6 dBm.

| Test port output power (dBm), high power | Typical                 | Nominal                 |
|--|-------------------------|-------------------------|
| <b>N991xA, N992xA</b>                    | <b>Port 1 or Port 2</b> | <b>Port 1 or Port 2</b> |
| 30 to 300 kHz                            | -11                     | —                       |
| > 300 kHz to 2 MHz                       | -3                      | -2                      |
| > 2 to 625 MHz                           | -2                      | -1                      |
| > 625 MHz to 3 GHz                       | 1                       | 3                       |
| > 3 to 6.5 GHz                           | -1                      | 1                       |
| > 6.5 to 9 GHz                           | -2                      | 0                       |
| > 9 to 14 GHz                            | -4                      | -2.5                    |
| > 14 to 18 GHz                           | -6                      | -4.5                    |
| > 18 to 23 GHz                           | -10                     | -8.5                    |
| > 23 to 26.5 GHz                         | -12                     | -11                     |
| Test port output power (dBm), low power  | Typical                 | Nominal                 |
| <b>N991xA, N992xA</b>                    | <b>Port 1 or Port 2</b> | <b>Port 1 or Port 2</b> |
| 30 kHz to 26.5 GHz                       | —                       | -45 (flattened)         |

## Cable and Antenna Analyzer and Vector Network Analyzer (continued)

### Test port output specifications (continued)

| Test port output power (dBm), high power | Typical  |               | Nominal |
|--|--|---------------|---------|
| <b>N995xA</b>                            | <b>Port 1</b>  | <b>Port 2</b> |         |
| 300 kHz to 2 MHz                         | -10  | -10           | —       |
| > 2 MHz to 1 GHz                         | 2  | 2             | —       |
| > 1 to 6.5 GHz                           | 2  | 0             | —       |
| > 6.5 to 18 GHz                          | 4  | 1             | —       |
| > 18 to 39 GHz                           | 1  | -2            | —       |
| > 39 to 46 GHz                           | -2   | -5            | —       |
| > 46 to 50 GHz                           | -4   | -7            | —       |
| Test port output power (dBm), low power  | Typical  |               | Nominal |
| <b>N995xA</b>                            | <b>Port 1</b>  | <b>Port 2</b> |         |
| 500 kHz to 10 MHz                        | -35  | -38           | —       |
| > 10 MHz to 10 GHz                       | -38  | -42           | —       |
| > 10 to 20 GHz                           | -43  | -47           | —       |
| > 20 to 44 GHz                           | -44  | -50           | —       |
| > 44 to 50 GHz                           | -53  | -55           | —       |
| Max leveled output power (dBm)           | Typical  |               | Nominal |
| <b>N995xA</b>                            | <b>Port 1</b>  | <b>Port 2</b> |         |
| 500 kHz to 10 MHz                        | -4   | -5            | —       |
| > 10 MHz to 25 GHz                       | 0  | 0             | —       |
| > 25 to 32 GHz                           | 0  | -4            | —       |
| > 32 to 44 GHz                           | -3   | -6            | —       |
| > 44 to 50 GHz                           | -7   | -10           | —       |
| Output power range                       |  |               |         |
| CAT                                      | High, low, and manual. Default (preset) power is high. Manual power is flattened.  |               |         |
| VNA                                      | High, low, and manual. Default (preset) power is manual, -15 dBm. Manual power is flattened.                                       |               |         |
| Power step size                          |  |               |         |
|  | Power settable in 1 dB steps across power range. Flat power, in 1 dB steps, is available across the whole frequency span, nominal. |               |         |
| Power level accuracy <sup>1</sup>        | Typical  |               |         |
| N991xA, N992xA                           | ± 1.5 dB at -15 dBm, for frequencies > 250 kHz   |               |         |
| N995xA                                   | ± 0.7 dB at -15 dBm, for frequencies > 500 kHz to 10 MHz<br>± 0.5 dB at -15 dBm, for frequencies > 10 MHz to 50 GHz                |               |         |
| Power level linearity                    | Nominal  |               |         |
| <b>N995xA</b>                            | <b>Port 1 or Port 2, -25 dBm ≤ P &lt; max leveled power</b>  |               |         |
| 10 MHz to 50 GHz                         | ± 0.5 dB   |               |         |

<sup>1</sup> N991xA and N992xA power levels are calibrated in the factory using a broadband power sensor, which means all tones (fundamental and harmonics) are included. N995xA power levels are calibrated based on PNA-X's tuned receiver, which means primarily the fundamental is included across all frequency bands. For older N995xA with series number prefix break <MY/SG/US6224, the broadband power sensor calibration method was used at <10 MHz, resulting in a higher reported combined tone power level.

## Cable and Antenna Analyzer and Vector Network Analyzer (continued)

### System performance specifications

| System dynamic range <sup>1,2</sup> (dB), high power, 300 Hz IFBW, 100 point average, Port 1 or Port 2 (-10 to 55 °C) |                                 |      |               |
|---|---------------------------------|------|---------------|
|   | Frequency                       | Spec | Typical       |
| N991xA, N992xA  | > 300 kHz to 9 GHz <sup>3</sup> | 95   | 100           |
|   | > 9 to 14 GHz                   | 91   | 97            |
|   | > 14 to 18 GHz                  | 90   | 94            |
|   | > 18 to 20 GHz                  | 87   | 90            |
|   | > 20 to 25 GHz                  | 74   | 79            |
|   | > 25 to 26.5 GHz                | 65   | 70            |
| N995xA  | > 300 kHz to 1 MHz              | —    | 70 (nominal)  |
|   | > 1 to 10 MHz                   | —    | 100 (nominal) |
|   | > 10 MHz to 20 GHz <sup>4</sup> | 100  | 110           |
|   | > 20 to 44 GHz <sup>5</sup>     | 90   | 100           |
|   | > 44 to 50 GHz <sup>6</sup>     | 81   | 90            |

| Measurement stability over temperature | Nominal          |                   |                |
|--|------------------|-------------------|----------------|
|  | Frequency        | Magnitude (dB/°C) | Phase (deg/°C) |
| N991xA, N992xA                         | 30 kHz to 15 GHz | ± 0.018           | —              |
|  | > 15 to 26.5 GHz | ± 0.080           | —              |
|  | ≤ 15 GHz         | ± 0.005           | ± 0.1          |
| N995xA                                 | ≤ 25 GHz         | ± 0.030           | ± 0.3          |
|  | > 25 GHz         | ± 0.060           | ± 0.6          |

| Measurement speed (Sweep time)   |                |            |
|--|----------------|------------|
| CAT  | N991xA, N992xA | N995xA     |
| Return loss, 30 kHz to 26.5 GHz, 1-port cal, 1001 points <sup>7</sup>                                  | 673 μs /pt     | —          |
| Return loss, 300 kHz to 50 GHz, 1-port cal, 1001 points  | —              | 686 μs /pt |
| Distance-to-fault, 100-meter cable, 1-port cal, 1001 points <sup>7</sup>                               | 782 μs /pt     | 760 μs /pt |
| VNA  | N991xA, N992xA | N995xA     |
| S11 and S21, 30 kHz to 26.5 GHz, enhanced response cal, 100 kHz IF bandwidth, 1001 points <sup>8</sup> | 432 μs /pt     | —          |
| S11 and S21, 300 kHz to 50 GHz, enhanced response cal, 100 kHz IF bandwidth, 1001 points               | —              | 478 μs /pt |

<sup>1</sup> System dynamic range is measured in the factory with loads on the test ports after a thru normalization.

<sup>2</sup> For CAT mode, "Insertion loss (2-port)", decrease listed dynamic range specifications by 20 dB, as CAT mode IFBW is fixed at 10 kHz. Can obtain full dynamic range by using S21 measurement in VNA mode with 100 Hz IFBW.

<sup>3</sup> < 300 kHz: 63 dB nominal; 2 to 9 MHz: 85 dB spec, 90 dB typical.

<sup>4</sup> Decrease by 3 dB from 15 to 15.8 GHz for S21.

<sup>5</sup> Decrease by 5 dB from 21.7 to 22.1 GHz for S21.

<sup>6</sup> Decrease by 4 dB from 44 to 50 GHz for S21.

<sup>7</sup> 850 μs /pt; slower speed applicable to FieldFox models with serial number prefix ≤ MY5607/SG5607/US5607 and FieldFox models not upgraded with the fast CPU Option N9910HU-100/200/300.

<sup>8</sup> 850 μs /pt; slower speed applicable to FieldFox models with serial number prefix ≤ MY5607/SG5607/US5607 and FieldFox models not upgraded with the fast CPU Option N9910HU-100/200/300.



## Cable and Antenna Analyzer and Vector Network Analyzer (continued)

### Test port input specifications

| Trace noise <sup>1</sup> , high power, 300 Hz IFBW, Port 1 or Port 2 |                                  | Spec (-10 to 55 °C)          |                 |
|--|----------------------------------|------------------------------|-----------------|
|  | Frequency                        | Magnitude (dB rms)           | Phase (deg rms) |
| N991xA, N992xA, N995xA   | > 300 kHz to 20 GHz <sup>2</sup> | 0.004                        | 0.07            |
|  | > 20 to 26.5 GHz                 | 0.007                        | 0.14            |
|  | > 26.5 to 30 GHz                 | 0.007                        | 0.14            |
|  | > 30 to 50 GHz                   | 0.008                        | 0.22            |
| Receiver compression   |                                  | Typical                      |                 |
|  | Frequency                        | Port 1 or Port 2             |                 |
| N991xA, N992xA   | 500 MHz to 1 GHz                 | +10 dBm, 0.15 dB compression |                 |
|  | > 1 to 26.5 GHz                  | +10 dBm, 0.10 dB compression |                 |
| N995xA   | 2 MHz to 50 GHz                  | +5 dBm, 0.10 dB compression  |                 |
| Maximum input level  |                                  | Port 1 or Port 2             |                 |
|  | Average CW power                 | DC                           |                 |
| N991xA, N992xA   | +27 dBm, 0.5 watts               | ± 50 VDC                     |                 |
| N991xA (with option V5K)   | +27 dBm, 0.5 watts               | ± 40 VDC                     |                 |
| N995xA   | +25 dBm, 0.3 watts               | ± 40 VDC                     |                 |
| Immunity to interfering signals                                      |                                  | Nominal                      |                 |
|  |                                  | +16 dBm                      |                 |

### CAT and VNA measurements

| CAT mode                         |  |
|----------------------------------|--|
| CAT measurements                 | Distance-to-fault (dB)<br>Return loss (dB)<br>Return loss and DTF (dB)<br>VSWR<br>Distance-to-fault (VSWR)<br>Cable loss (1-port)<br>Insertion loss (2-port) (requires option 211)<br>Distance-to-fault (Lin)<br>TDR (Lin rho) (requires option 215)<br>TDR (ohm) (requires option 215)<br>TDR & DTF (requires option 215) |
| Distance-to-fault (DTF) settings |  |
| Frequency/distance               | Start distance, stop distance  |
| Sweep time                       | Units: meters or feet (Can also be set as Preferences)   |
| Frequency mode                   | Bandpass, lowpass  |
| CAT mode averaging               | Set sweep time in seconds  |

<sup>1</sup> For CAT mode, increase trace noise by a factor of 5.7, as CAT mode IFBW is fixed at 10 kHz. Can use averaging in CAT mode to reduce trace noise or use VNA mode with 300 Hz IFBW.

<sup>2</sup> Excludes multiples of 390 kHz.

## Cable and Antenna Analyzer and Vector Network Analyzer (continued)

### CAT and VNA measurements (continued)

| <b>CAT mode</b>                   |   |
|-----------------------------------|---|
| Distance-to-fault                 | Available in CAT mode. Standard on N991xA and N995x analyzers.<br>Option 305 on N992xA analyzers<br>Range = velocity factor x speed of light x (number of points - 1) / frequency span x 2<br>Number of points auto coupled according to start and stop distance entered.<br>Resolution = range / (number of points - 1)<br>Transform modes: Bandpass, low-pass<br>Window types: Maximum, medium, and minimum<br>Alias free range indicator: On/Off<br>Dispersion compensation for waveguide: Yes |
| Return loss, log magnitude        | -500 to 500 dB  |
| Log magnitude resolution          | 0.01 dB   |
| VSWR                              | 1.01 to 1000  |
| VSWR resolution                   | 0.01  |
| <b>VNA mode</b>                   |   |
| VNA Transmission/Reflection (T/R) | S11, S21 magnitude and phase (requires option 210)  |
| VNA S-parameters                  | S11, S21, S22, S12 magnitude and phase (requires options 210 and 211)   |
| Number of traces                  | Four traces available: Tr1, Tr2, Tr3, Tr4   |
| Display formats                   | Single-trace<br>Dual-trace split (each trace on separate graticule)<br>Dual-trace overlay (both traces on one graticule)<br>Three-trace split (each trace on separate graticule)<br>Three-trace overlay (all three traces on one graticule)<br>Quad-trace split (each trace on separate graticule)<br>Quad-trace overlay (all four traces on one graticule)   |
| VNA trace formats                 | Log magnitude, linear magnitude, VSWR, phase, Smith chart, polar, group delay, unwrapped phase, real impedance, imaginary impedance, Z magnitude  |
| Frequency settings                | Start, stop, center, span   |
| Frequency sweep type              | Linear  |
| Sweep type trigger                | Continuous, single  |
| Sweep trigger source              | Internal, external, point (point trigger applies to 1-port cal only)  |
| Sweep trigger slope               | Positive, negative  |
| Sweep trigger delay               | 0 to 10 seconds   |
| Averaging                         | Sweep averaging: 2 to 1000  |
| Smoothing                         | Computes the moving average of adjacent data points. Smoothing aperture defines the trace width (number of points) to be averaged.<br>Minimum aperture: 0.05% of frequency span<br>Maximum aperture: 25% of frequency span  |
| Scale                             | Autoscale, scale, reference level, reference position<br>Autoscale: Automatically selects scale resolution and reference value to center the trace.<br>Autoscale all: Scales all visible traces.  |

## Cable and Antenna Analyzer and Vector Network Analyzer (continued)

### CAT and VNA measurements (continued)

| <b>VNA mode</b>                |  |
|--------------------------------|--|
| S11, log magnitude             | -500 to 500 dB   |
| Log magnitude resolution       | 0.01 dB  |
| VSWR                           | 1.01 to 1000   |
| VSWR resolution                | 0.01   |
| Phase                          | -180 to +180 degrees (unwrapped phase can show larger values)  |
| Phase resolution               | 0.01 degrees   |
| Phase offset                   | -360 to +360 degrees   |
| Magnitude offset               | -100 to +100 dB  |
| Trace math                     | Vector division or subtraction of current linear measurement values and memory data  |
| Port extension                 | For both port 1 and port 2, delay settings. Port extensions apply to all measurements.   |
| Marker formats                 | Default marker format is the trace format. Other formats:<br>R + jX<br>Z magnitude<br>Phase<br>Real<br>Imaginary<br>Mag & Phase<br>dB Angle  |
| <b>General CAT / VNA modes</b> |  |
| Marker functions               | Peak, Next Peak, Peak Left, Peak Right, Mkr→Center, Mkr→Delay, Min Search, Peak Excursion, Peak Threshold, Target, Bandwidth (BW, Q, Loss), Tracking CAT mode only: Tracking 3 peaks (CAT mode), Marker→Start distance, Marker→Stop distance |
| Marker table                   | On/Off   |
| Marker types                   | Normal, delta, data trace and memory trace markers   |
| Marker coupling                | On/Off (coupling between traces)   |
| Frequency blanking             | Security level: none, high. If high, all frequency information is blanked out. An instrument preset is required to re-enable the frequency information.  |
| Display data                   | Display data, memory, data and memory, or data math  |
| Trace math                     | One memory trace per data trace.   |

## Cable and Antenna Analyzer and Vector Network Analyzer (continued)

### CAT and VNA mode calibrations

FieldFox analyzers offer three tiers of calibrations, thus providing users with different levels of calibration effort and accuracy.

#### CalReady

CalReady is the most basic calibration and is sufficient for a quick pass/fail or go/no go verification. Every FieldFox is calibrated at the factory, at test ports 1 and 2, at room temperature. CalReady can be applied either as an “enhanced response CalReady” or a “2-port CalReady.” The default setting is 2-port CalReady, so correction is applied to both ports. A user preference allows user to change the CalReady methodology to enhanced response CalReady.

A 30-minute warm-up period is recommended for a quick test. A 90-minute warm-up is necessary for more stringent test requirements.

If CalReady is the basis for most measurements, the annual cal cycle must be followed, as the CalReady calibration will be updated during the annual cal cycle.

#### QuickCal

QuickCal is the next level of calibration. QuickCal uses internal standards and a subset of external standards and builds on the factory-created CalReady. Users can perform QuickCal with a load or without a load. A QuickCal calibration with a load yields a more accurate measurement.

Important note: QuickCal is most accurate for DUTs with 7/16 and Type-N connectors and measurement uncertainties are provided for frequencies  $\leq 18$  GHz. Accuracy is reduced for DUTs with 3.5 mm (m), SMA (m), or other male coaxial connectors; performance is unspecified. QuickCal is not recommended for DUTs with 3.5 mm (f), SMA (f), or other similar female connectors. QuickCal is not applicable to waveguide.

A 60-minute warm-up period is recommended.

If QuickCal is the basis for most measurements, it is highly recommended that the annual cal cycle be followed, as QuickCal builds on CalReady and CalReady data are updated during the annual cal cycle.

## Cable and Antenna Analyzer and Vector Network Analyzer (continued)

### Standard calibrations

Standard calibrations are the most accurate calibrations offered in FieldFox. FieldFox's calibration engine is based on Keysight's flagship PNA calibration engine, and as such, offers many of the standard calibrations. FieldFox supports both coaxial and waveguide calibrations. The table below lists the commonly used calibrations.

A 60-minute warm-up period is recommended for standard calibrations. For ultimate in stability and accuracy, a 90-minute warm-up period is necessary

|  |  |
|--|--|
| Frequency response<br>Open response<br>Short response<br>Thru response<br>With and without isolation           | Simultaneous magnitude and phase correction of frequency response errors for either reflection or transmission measurements. Isolation corrects for crosstalk errors.  |
| 1-port OSL (Port 1)<br>1-port OSL (Port 2)   | Open, short, and load<br>Traditional 1-port calibration for reflection measurements. Corrects for directivity, source match, and frequency response errors.  |
| SSL (for waveguide)  | For waveguide calibrations, depending on the calibration kit definition, this is presented as a short, offset short and load calibration.  |
| Enhanced response (also known as one-path, two-port)<br>Forward enhanced response<br>Reverse enhanced response | Corrects for frequency response and source match. Partial correction for load match for low-loss reciprocal devices.   |
| QSOLT (2-port)   | QSOLT or Quick short-open-load-thru is FieldFox's default recommended calibration for insertable devices. Full 12-term error correction. Requires fewer connections, compared to traditional SOLT (4 compared to 7). Corrects for directivity, source match, reflection frequency response, load match, and transmission frequency response. |
| Full 2-port (unknown thru calibration)   | FieldFox's default recommended calibration for non-insertable devices. Full 12-term error correction. Beneficial for characterizing non-insertable devices such as Type-N to 3.5 mm, or female-female devices. Corrects for directivity, source match, reflection frequency response, load match, and transmission frequency response.       |
| TRL  | TRL or thru-reflect-line compensates for directivity, reflection, and transmission frequency response in both the forward and reverse directions.  |

\*\* Note: FieldFox does not offer the traditional SOLT calibration. Instead, it offers the more accurate Full 2-port (unknown thru), and also QSOLT.

### ECal

FieldFox supports all Keysight USB ECal modules, both standard and value-line ECals.

### FieldFox's guided calibration wizard

FieldFox's calibration wizard recommends a calibration type and calibration kit based on selected parameters and connector types. Alternatively, users can select their own calibration type and calibration kit. FieldFox's calibration wizard ensures a valid calibration selection.

## Cable and Antenna Analyzer and Vector Network Analyzer (continued)

### Interpolation error correction

With any type of accuracy enhancement applied, interpolated mode recalculates the error coefficients when the test frequencies are changed. The number of points can be increased or decreased, and the start/stop frequencies can be changed, but the resulting frequency span must be a subset of the original calibration frequency span.

### Connectors

The following connector types are included by default with the FieldFox firmware. Additional connector types can be added by adding a new calibration kit that is based on the new connector type.

| Coaxial       | Waveguide |
|---------------|-----------|
| Type-N 50 ohm | WR-10     |
| Type-N 75 ohm | WR-15     |
| 7/16          | WR-22     |
| TNC           | WR-28     |
| Type-F        | WR-42     |
| 7 mm          | WR-62     |
| 3.5 mm        | WR-75     |
| 2.4 mm        | WR-90     |
| 2.92 mm       | WR-112    |
|               | WR-137    |
|               | WR-187    |
|               | WR-284    |
|               | WR-650    |

### FieldFox S-parameter measurement uncertainty charts

This data sheet includes measurement uncertainty charts for the configurations listed in the table below. Additional uncertainty charts are available in the secondary data sheet 5992-1926EN.

| FieldFox model                   | Calibration kit  | Calibration type        | DUT connector | Uncertainty |
|----------------------------------|------------------|-------------------------|---------------|-------------|
| N9913/4/5/6/7/8A & N9925/6/7/8A  | —                | QuickCal                | Type-N(m)     | Nominal     |
| N9913/4/5/6/7/8A & N9925/6/7/8A  | 85518A or 85519A | Full 2-port calibration | Type-N        | Spec        |
| N9913/4/5/6/7/8A & N9925/6/7/8A  | 85054D           | Full 2-port calibration | Type-N        | Spec        |
| NN9913/4/5/6/7/8A & N9925/6/7/8A | 85520A or 85521A | Full 2-port calibration | 3.5 mm        | Spec        |
| N9913/4/5/6/7/8A & N9925/6/7/8A  | 85052D           | Full 2-port calibration | 3.5 mm        | Spec        |
| N9950/1/2A                       | 85056D           | Full 2-port calibration | 2.4 mm        | Spec        |
| N9950/1/2A                       | N4693D ECal      | Full 2-port calibration | 2.4 mm        | Spec        |

# Corrected Measurement Uncertainty

## N9913/4/5/6/7/8A and N9925/6/7/8A, QuickCal, DUT: Type-N(m), Nominal<sup>1</sup>

Power level of -15 dBm, 10 Hz IF bandwidth, no averaging, battery saver off, and 30-minute warm-up time. Includes uncertainties due to drift, noise, compression, and dynamic accuracy. Coverage factor of x1 applied to uncertainties, for ease of comparison with other industry handheld analyzers.

### Transmission uncertainty (S21, S12)

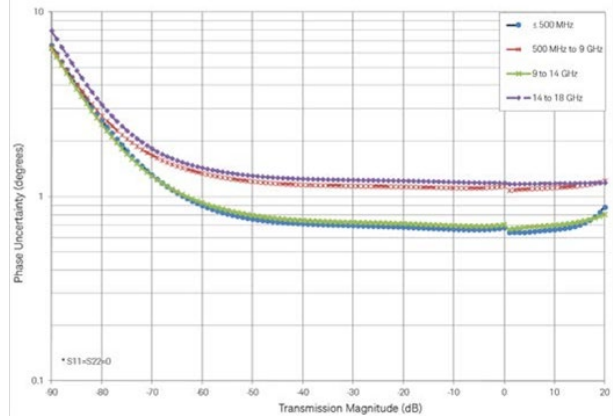
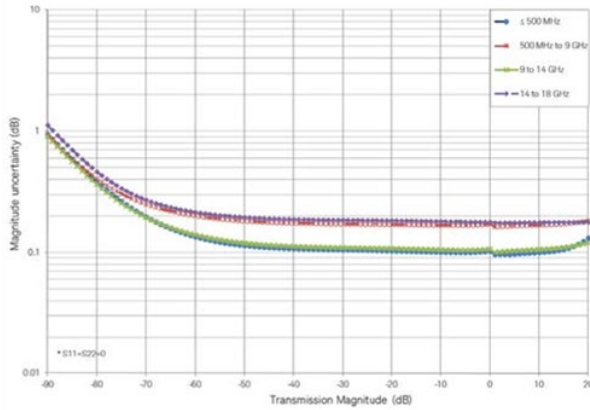

### Reflection uncertainty (S11, S22)

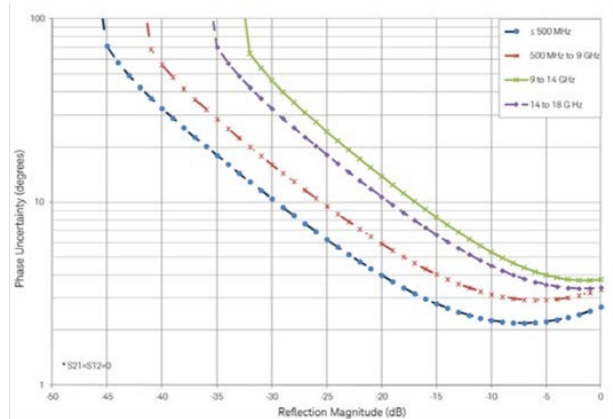
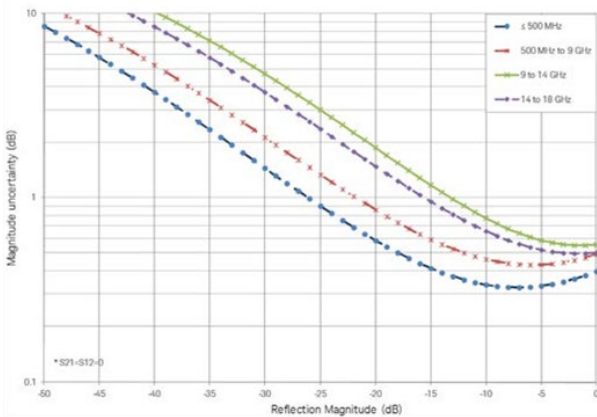

<sup>1</sup> Uncertainties shown based on a factory calibration using data-based calibration kits.

## Corrected Measurement Uncertainty (continued)

### N9913/4/5/6/7/8A and N9925/6/7/8A, 85518A or 85519A, Full 2-port Cal, DUT: Type-N, Spec

Power level of -15 dBm, 10 Hz IF bandwidth, no averaging, battery saver off, and 60-minute warm-up time. Includes uncertainties due to drift, noise, compression, and dynamic accuracy. Coverage factor of x1 applied to uncertainties, for ease of comparison with other industry handheld analyzers.

| Corrected performance (dB) | 0.2 to 500 MHz <sup>1</sup> | 0.5 to 2 GHz | 2 to 9 GHz | 9 to 18 GHz |
|----------------------------|-----------------------------|--------------|------------|-------------|
| Directivity                | 44                          | 42           | 35         | 32          |
| Source match               | 37                          | 36           | 33         | 30          |
| Load match                 | 37                          | 36           | 33         | 30          |
| Reflection tracking        | ± 0.050                     | ± 0.060      | ± 0.070    | ± 0.100     |
| Transmission tracking      | ± 0.050                     | ± 0.060      | ± 0.070    | ± 0.100     |

### Transmission uncertainty (S21, S12)

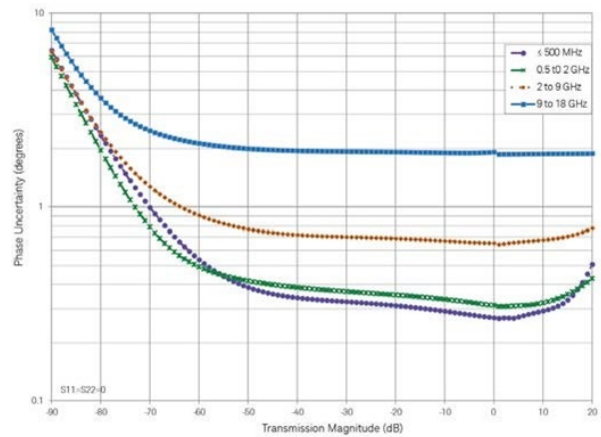
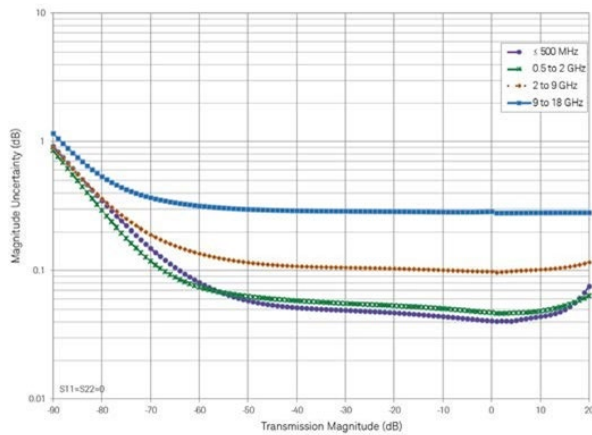

### Reflection uncertainty (S11, S22)

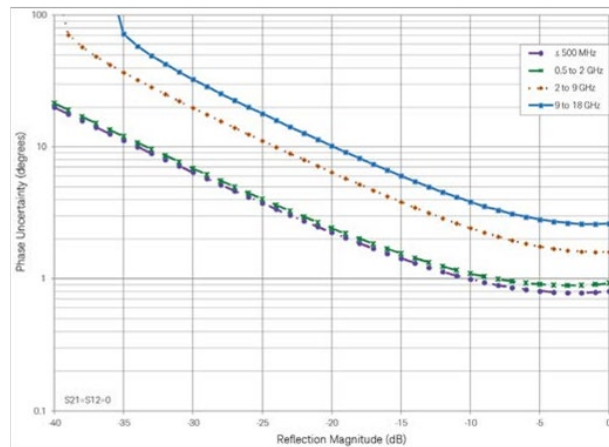
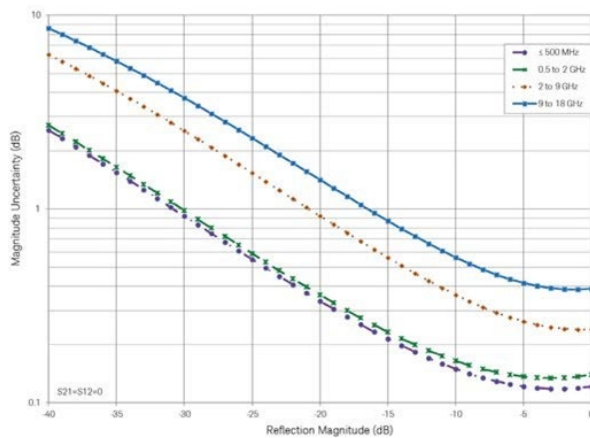

<sup>1</sup> Start frequency of 200 kHz applies to measurement uncertainty charts.



## Corrected Measurement Uncertainty (continued)

### N9913/4/5/6/7/8A and N9925/6/7/8A, 85054D, Full 2-port Cal, DUT: Type-N, Spec

Power level of -15 dBm, 10 Hz IF bandwidth, no averaging, battery saver off, and 60-minute warm-up time. Includes uncertainties due to drift, noise, compression, and dynamic accuracy. Coverage factor of x1 applied to uncertainties, for ease of comparison with other industry handheld analyzers.

| Corrected performance (dB) | 0.2 to 500 MHz <sup>1</sup> | 0.5 to 2 GHz | 2 to 8 GHz | 8 to 18 GHz |
|----------------------------|-----------------------------|--------------|------------|-------------|
| Directivity                | 40                          | 40           | 36         | 34          |
| Source match               | 38                          | 33           | 33         | 27          |
| Load match                 | 38                          | 33           | 33         | 27          |
| Reflection tracking        | ± 0.006                     | ± 0.006      | ± 0.009    | ± 0.027     |
| Transmission tracking      | ± 0.006                     | ± 0.006      | ± 0.009    | ± 0.027     |

#### Transmission uncertainty (S21, S12)

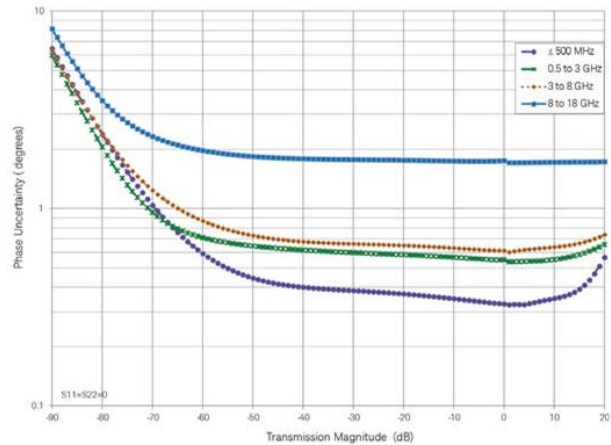
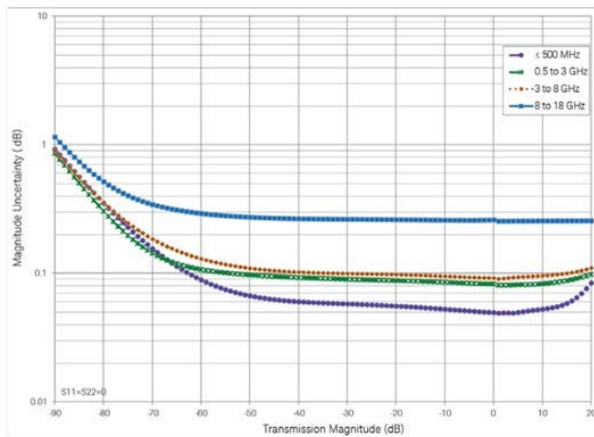

#### Reflection uncertainty (S11, S22)

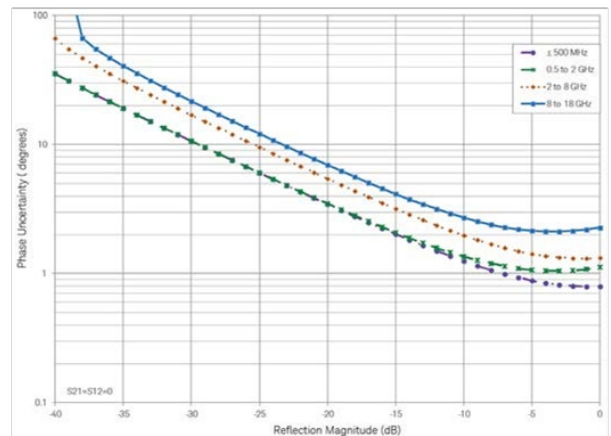
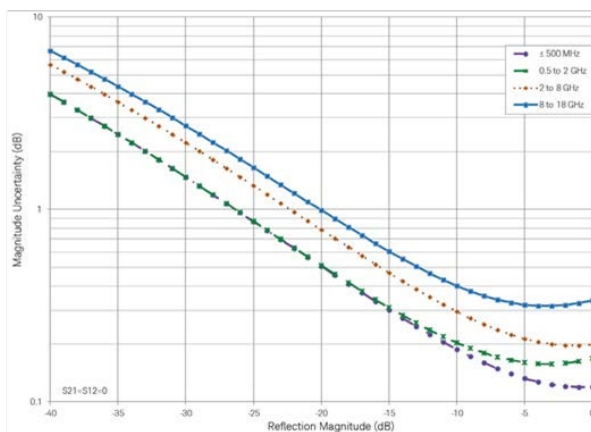

<sup>1</sup> Start frequency of 200 kHz applies to measurement uncertainty charts.

## Corrected Measurement Uncertainty (continued)

### N9913/4/5/6/7/8A and N9925/6/7/8A, 85520A or 85521A, Full 2-port Cal, DUT: 3.5 mm, Spec

Power level of -15 dBm, 10 Hz IF bandwidth, no averaging, battery saver off, and 60-minute warm-up time. Includes uncertainties due to drift, noise, compression, and dynamic accuracy. Coverage factor of x1 applied to uncertainties, for ease of comparison with other industry handheld analyzers.

| Corrected performance (dB) | 0.2 to 500 MHz <sup>1</sup> | 0.5 to 9 GHz | 9 to 18 GHz | 18 to 26.5 GHz |
|----------------------------|-----------------------------|--------------|-------------|----------------|
| Directivity                | 42                          | 36           | 32          | 32             |
| Source match               | 37                          | 30           | 28          | 27             |
| Load match                 | 37                          | 30           | 28          | 27             |
| Reflection tracking        | ± 0.035                     | ± 0.130      | ± 0.140     | ± 0.210        |
| Transmission tracking      | ± 0.035                     | ± 0.130      | ± 0.140     | ± 0.210        |

### Transmission uncertainty (S21, S12)

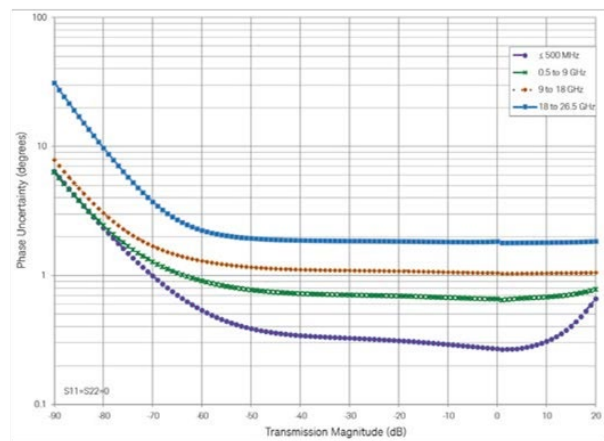
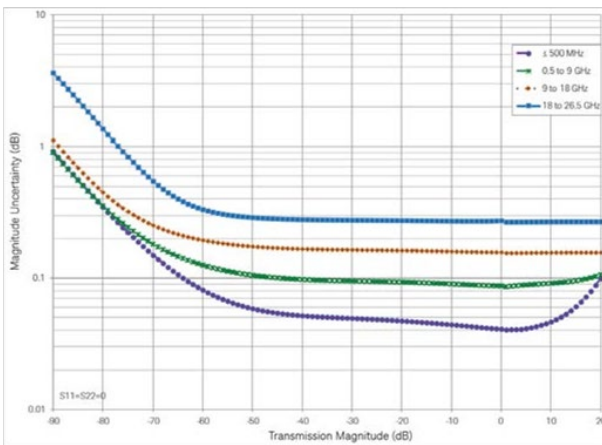

### Reflection uncertainty (S11, S22)

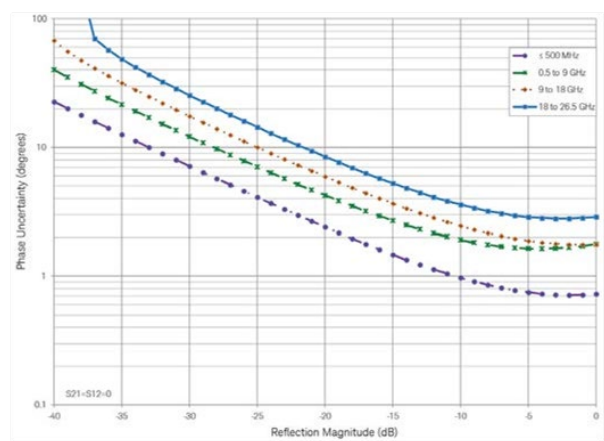
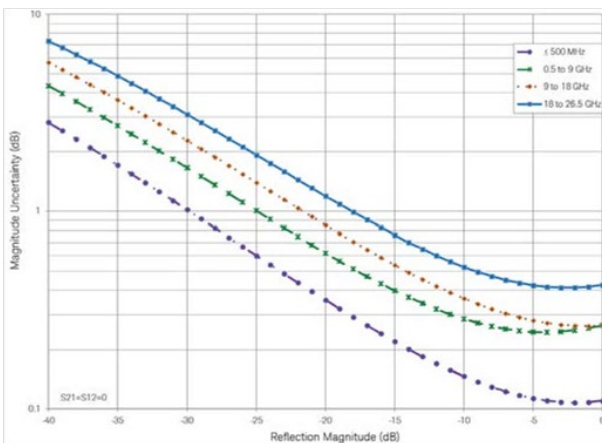

<sup>1</sup> Start frequency of 200 kHz applies to measurement uncertainty charts.

## Corrected Measurement Uncertainty (continued)

### N9913/4/5/6/7/8A and N9925/6/7/8A, 85052D, Full 2-port Cal, DUT: 3.5 mm, Spec

Power level of -15 dBm, 10 Hz IF bandwidth, no averaging, battery saver off, and 60-minute warm-up time. Includes uncertainties due to drift, noise, compression, and dynamic accuracy. Coverage factor of x1 applied to uncertainties, for ease of comparison with other industry handheld analyzers.

| Corrected performance (dB) | 0.2 to 500 MHz <sup>1</sup> | 0.5 to 8 GHz | 8 to 20 GHz | 20 to 26.5 GHz |
|----------------------------|-----------------------------|--------------|-------------|----------------|
| Directivity                | 42                          | 38           | 36          | 30             |
| Source match               | 37                          | 31           | 28          | 25             |
| Load match                 | 37                          | 31           | 28          | 25             |
| Reflection tracking        | ± 0.005                     | ± 0.006      | ± 0.009     | ± 0.012        |
| Transmission tracking      | ± 0.005                     | ± 0.006      | ± 0.009     | ± 0.012        |

### Transmission uncertainty (S21, S12)

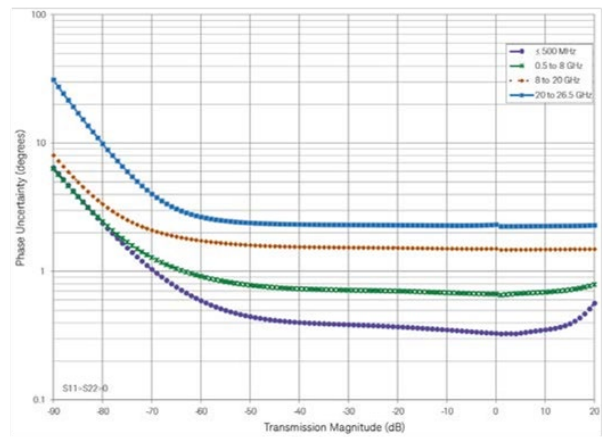
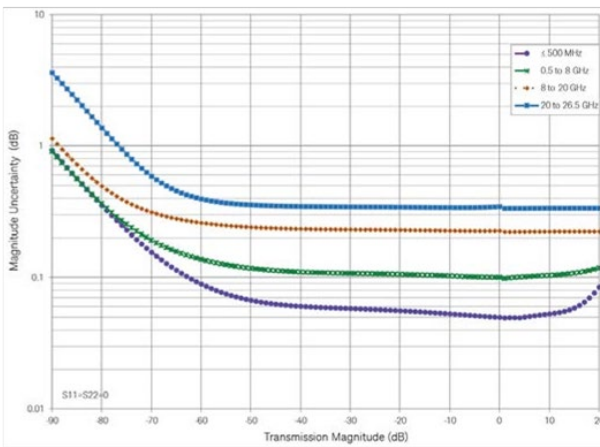

### Reflection uncertainty (S11, S22)

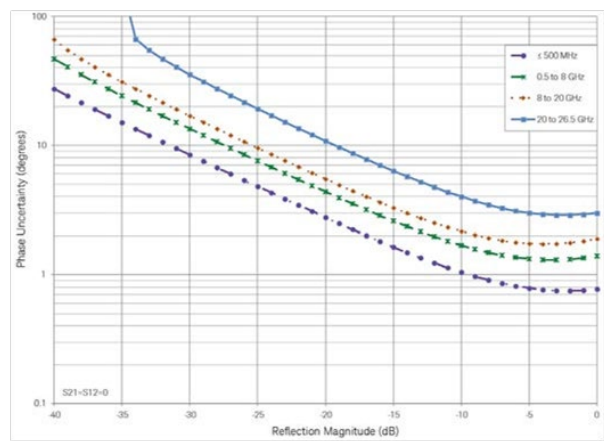
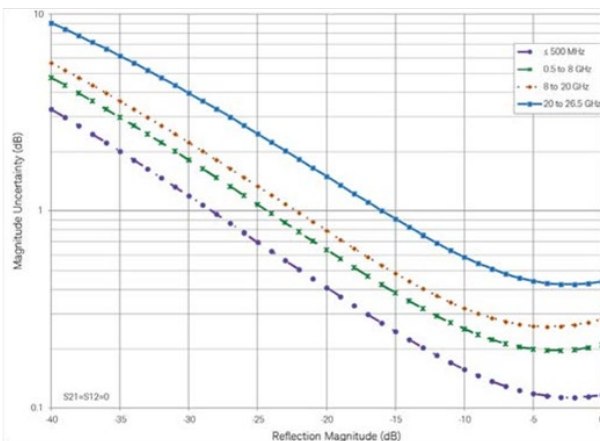

<sup>1</sup> Start frequency of 200 kHz applies to measurement uncertainty charts.

## Corrected Measurement Uncertainty (continued)

N9950/1/2A, 85056D, Full 2-port Cal, DUT: 2.4 mm, Spec<sup>1</sup>

Power level of -15 dBm, 10 Hz IF bandwidth, no averaging, battery saver off, and 60-minute warm-up time. Includes uncertainties due to drift, noise, compression, and dynamic accuracy. Coverage factor of x1 applied to uncertainties, for ease of comparison with other industry handheld analyzers.

| Corrected performance (dB) | ≤ 2 GHz | 2 to 20 GHz | 20 to 40 GHz | 40 to 50 GHz |
|----------------------------|---------|-------------|--------------|--------------|
| Directivity                | 42      | 34          | 26           | 26           |
| Source match               | 39      | 30          | 23           | 23           |
| Load match                 | 39      | 30          | 23           | 23           |
| Reflection tracking        | ± 0.002 | ± 0.029     | ± 0.080      | ± 0.075      |
| Transmission tracking      | ± 0.002 | ± 0.029     | ± 0.080      | ± 0.075      |

### Transmission uncertainty (S<sub>21</sub>, S<sub>12</sub>)

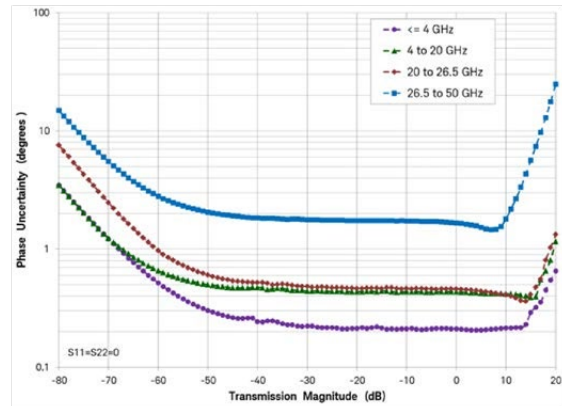
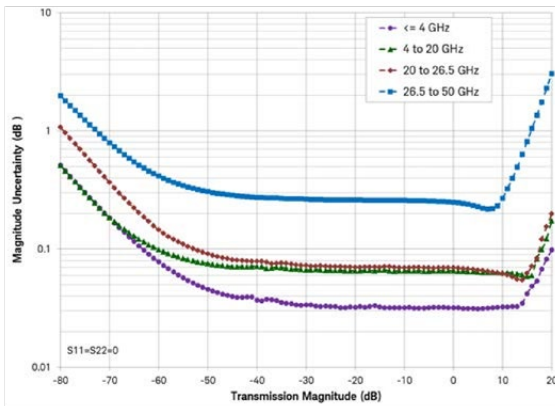

### Reflection uncertainty (S<sub>11</sub>, S<sub>22</sub>)

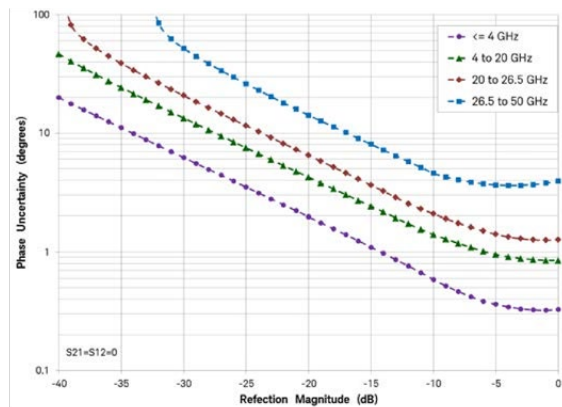
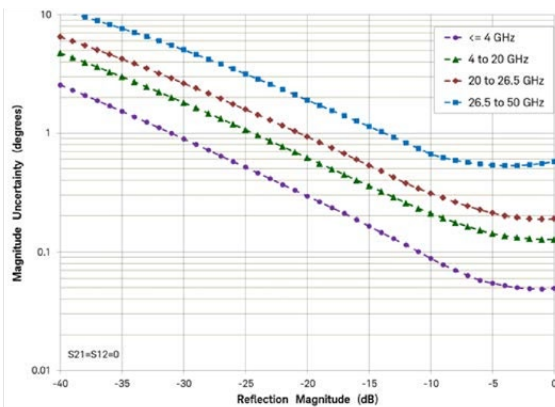

<sup>1</sup> Uncertainty curves shown are calculated based on ISO GUM methodology. The values in the table are provided for reference only, in accordance to legacy uncertainty methods.

## Corrected Measurement Uncertainty (continued)

### N9950/1/2A, N4693D ECal, Full 2-port Cal, DUT: 2.4 mm, Spec<sup>1</sup>

Corrected performance table calculated using uncertainties with a coverage factor of 2.

| Corrected performance (dB) <sup>2</sup> | .2 to 45 MHz <sup>3</sup> | 10 MHz to 45 MHz <sup>4</sup> | 45 to 200 MHz | 200 MHz to 2 GHz | 2 to 10 GHz | 10 to 20 GHz | 20 to 40 GHz | 40 to 50 GHz |
|---|---------------------------|-------------------------------|---------------|------------------|-------------|--------------|--------------|--------------|
| Directivity                             | 40                        | 27                            | 40            | 46               | 47          | 44           | 38           | 34           |
| Source match                            | 38                        | 25                            | 44            | 46               | 42          | 37           | 35           | 32           |
| Load match                              | 38                        | 25                            | 44            | 46               | 42          | 37           | 35           | 32           |
| Reflection tracking                     | ± 0.05                    | ± 0.05                        | ± 0.05        | ± 0.03           | ± 0.04      | ± 0.05       | ± 0.06       | ± 0.08       |
| Transmission tracking                   | ± 0.05                    | ± 0.05                        | ± 0.05        | ± 0.03           | ± 0.04      | ± 0.05       | ± 0.06       | ± 0.08       |

Uncertainty plots: power level of -15 dBm, 10 Hz IF bandwidth, no averaging, battery saver off, and 60-minute warm-up time. Includes uncertainties due to drift, noise, compression, and dynamic accuracy. Coverage factor of x1 applied to uncertainties, for ease of comparison with other industry handheld analyzers.

### Transmission uncertainty (S<sub>21</sub>, S<sub>12</sub>)

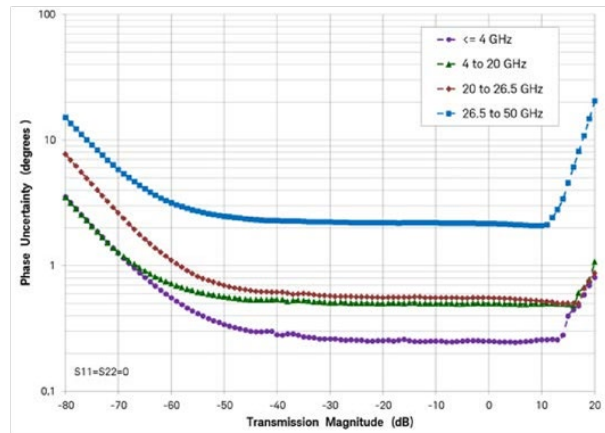
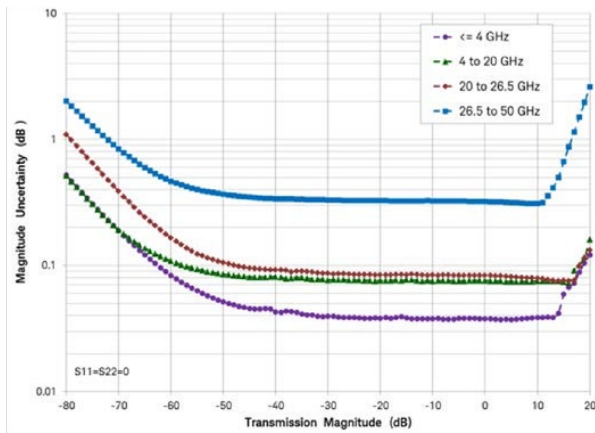

### Reflection uncertainty (S<sub>11</sub>, S<sub>22</sub>)

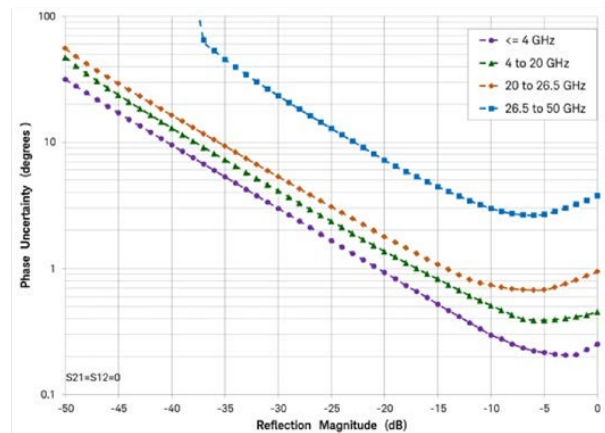
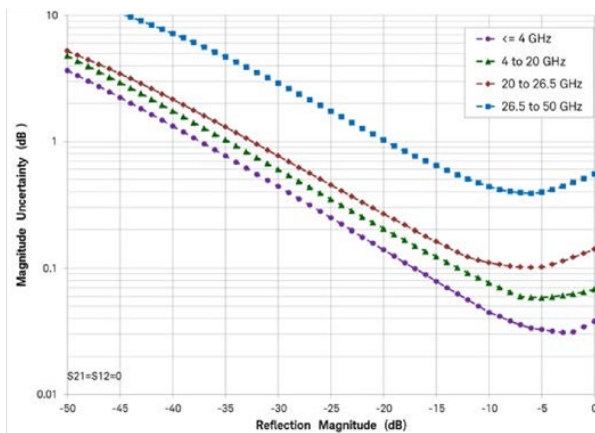

<sup>1</sup> Uncertainty plots generated with data from N4693B and are based on ISO GUM methodology. The values in the table are provided for reference only, in accordance to legacy uncertainty methods.

<sup>2</sup> When applied power exceeds -10 dBm, calibration results will be degraded from the performance indicated in this table.

<sup>3</sup> For N4693D ECal Option ODC.

<sup>4</sup> For N4693D ECal Option 010.

The performance listed in TDR cable measurements, VNA time domain, mixed-mode S-parameters and vector voltmeter sections applies to the capabilities available in the following models:

|  |  |
|--|--|
| FieldFox RF & microwave (combination) analyzers: | N9913A, N9914A, N9915A, N9916A, N9917A, N9918A<br>N9950A, N9951A, N9952A |
| FieldFox microwave vector network analyzers:     | N9925A, N9926A, N9927A, N9928A   |

See [FieldFox Configuration Guide](#) for option information. Many capabilities listed in this Data Sheet require options.

## TDR Cable Measurements (Option 215)

The TDR cable option adds time domain reflectometry (TDR) measurements to FieldFox's CAT mode. FieldFox's TDR measurements are based on an inverse Fourier transform of the frequency-domain data. TDR measurements are useful in not only identifying the location of faults along cables, but also the nature of the fault. Resistive, inductive and capacitive faults will each have a different response. These differences help engineers and technicians trouble-shoot line faults.

Measurements: TDR (linear rho), TDR (ohm), TDR & DTF

Y-axis: linear (rho) or impedance (ohm)

X-axis: distance (meters or feet)

## VNA Time Domain (Option 010)

In time-domain mode, FieldFox computes the inverse Fourier transform of the frequency-domain data to display reflection or transmission coefficients versus time.

| Setup parameters   |  |
|--|--|
| Time   | Start, stop, center, span  |
| Gating   | Start, stop, center, span, and on/off  |
| Numbers of points, velocity vector, line loss, window shape, independent control for all four traces   |  |
| Time stimulus modes  |  |
| Low-pass step  | Low-pass step is similar to a traditional time domain reflectometer (TDR) stimulus waveform. It is used to measure low-pass devices. The frequency-domain data should extend from DC (extrapolated value) to a higher value. |
| Low-pass impulse   | Low-pass impulse response is used to measure low-pass devices.   |
| Bandpass impulse   | The bandpass impulse simulates a pulsed RF signal and is used to measure the time domain response of band-limited devices.   |
| Windows  |  |
| The windowing function can be used to filter the frequency domain data and thereby reduce overshoot and ringing in the time domain response.   |  |
| Windows  | Minimum, medium and maximum, manual entry of Kaiser Beta and impulse width.  |
| Gating   |  |
| The gating function can be used to selectively remove reflection or transmission time domain responses. In converting back to the frequency domain, the effects of the responses outside the gate are removed. The results can be viewed with gating on and off, using two traces. |  |
| Gate types   | Notch, bandpass  |
| Gate shapes  | Maximum, wide, normal, minimum   |

## Mixed-Mode S-Parameters (Option 212)

Mixed-mode S-parameters are also known as balanced measurements.

| Measurements |  |
|--------------|--|
| Scc11        | Common mode reflection                           |
| Sdd11        | Differential mode reflection                     |
| Scd11        | Differential mode stimulus, common mode response |
| Sdc11        | Common mode stimulus, differential mode response |

FieldFox's mixed-mode S-parameter measurements require the use of the default factory calibration or a user 2-port calibration. So, the FieldFox analyzer must be equipped with 2-port measurement functionality to measure mixed-mode S-parameters. Mixed-mode S-parameters are an extension of the VNA capabilities.

## Vector Voltmeter (VVM) (Option 308)

With vector voltmeter mode, you can characterize the difference between two measurements easily. The zeroing function allows you to create a reference signal and characterize the difference between two device measurements. The results are shown on a large display in digital format.

|                       | Models   | Frequency range    |
|-----------------------|--|--------------------|
| N991xA, N992xA        | N9913A   | 30 kHz to 4 GHz    |
|                       | N9914A   | 30 kHz to 6.5 GHz  |
|                       | N9915A, N9925A   | 30 kHz to 9 GHz    |
|                       | N9916A, N9926A   | 30 kHz to 14 GHz   |
|                       | N9917A, N9927A   | 30 kHz to 18 GHz   |
|                       | N9918A, N9928A   | 30 kHz to 26.5 GHz |
| N995xA                | N9950A   | 300 kHz to 32 GHz  |
|                       | N9951A   | 300 kHz to 44 GHz  |
|                       | N9952A   | 300 kHz to 50 GHz  |
| Setup parameters      |  |                    |
| 1-port cable trimming | Reflection (S11 or S22 measurement), magnitude and phase   |                    |
| 2-port transmission   | Transmission or S21 measurement, magnitude and phase   |                    |
| A/B and B/A           | Ratio of two receivers or channels, magnitude and phase – Need an external signal generator for the A/B or B/A measurement |                    |
|                       | Frequency (one CW frequency point)   |                    |
|                       | IF bandwidth: 10 Hz to 100 kHz or 3 Hz to 30 kHz   |                    |
|                       | Output power: Low, high, manual  |                    |

## Ratio accuracy (A/B and B/A)

Must zero before measuring DUT. Recommend using a high-quality power splitter or 6 dB attenuators to minimize uncertainty due to mismatch.

|                           | Frequency                   | Nominal (dB) |
|---------------------------|-----------------------------|--------------|
| N991xA, N992xA,<br>N995xA | 100 to 300 kHz <sup>1</sup> | ± 1.0        |
|                           | > 300 kHz to 1 MHz          | ± 0.4        |
|                           | > 1 to 100 MHz              | ± 0.2        |
|                           | > 100 to 300 MHz            | ± 0.4        |
|                           | > 300 MHz to 1.5 GHz        | ± 0.6        |
|                           | > 1.5 to 2 GHz              | ± 1.0        |

<sup>1</sup> Does not apply to N995xA models, which start at 300 kHz.



## Spectrum Analyzer (Option 233 on Combination Analyzers)

The performance listed in this section applies to the spectrum analyzer capabilities available in the following models:

|  |  |
|--|--|
| FieldFox RF & microwave (combination) analyzers: | N9913A, N9914A, N9915A, N9916A, N9917A, N9918A<br>N9950A, N9951A, N9952A |
| FieldFox microwave spectrum analyzers:           | N9935A, N9936A, N9937A, N9938A<br>N9960A, N9961A, N9962A                 |

See [FieldFox Configuration Guide](#) for option information. Many capabilities listed in this Data Sheet require options.

### Frequency and time specifications

|                | Models         | Frequency range <sup>1</sup> |
|----------------|----------------|------------------------------|
| N991xA, N993xA | N9913A         | 5 kHz to 4 GHz               |
|                | N9914A         | 5 kHz to 6.5 GHz             |
|                | N9915A, N9935A | 5 kHz to 9 GHz               |
|                | N9916A, N9936A | 5 kHz to 14 GHz              |
|                | N9917A, N9937A | 5 kHz to 18 GHz              |
|                | N9918A, N9938A | 5 kHz to 26.5 GHz            |
| N995xA, N996xA | N9950A, N9960A | 5 kHz to 32 GHz              |
|                | N9951A, N9961A | 5 kHz to 44 GHz              |
|                | N9952A, N9962A | 5 kHz to 50 GHz              |

#### Frequency reference, -10 to 55 °C

|  |   |
|--|---|
| Accuracy                                   | ± 0.7 ppm (spec) + aging                                  |
|  | ± 0.4 ppm (typical) + aging                               |
| Accuracy, when locked to GPS               | ± 0.01 ppm (spec) <sup>2</sup>                            |
| Accuracy, when GPS antenna is disconnected | ± 0.2 ppm (nominal) <sup>3</sup>                          |
| Aging rate                                 | ± 1 ppm/yr for 20 years (spec), will not exceed ± 3.5 ppm |

#### Frequency readout accuracy (start, stop, center, marker)

|  |  |
|--|--|
| ± (readout frequency x frequency reference accuracy + RBW centering + 0.5 x horizontal resolution) | Horizontal resolution = frequency span / (trace points – 1)<br>RBW centering:  |
|  | <ul style="list-style-type: none"> <li>• 5% x RBW, FFT mode (nominal)</li> <li>• 16% x RBW, step mode (nominal)</li> </ul> |

#### Marker frequency counter

|            |  |
|------------|--|
| Accuracy   | ± (marker frequency x frequency reference accuracy + counter resolution) |
| Resolution | 0.1, 1, 10 Hz  |

<sup>1</sup> The spectrum analyzer is tunable to 0 Hz or DC.

<sup>2</sup> This is a pass-through specification provided by the GPS vendor and is not verified by Keysight.

<sup>3</sup> The maximum drift expected in the frequency reference applicable when the ambient temperature changes ± 5°C from the temperature when the GPS signal was last connected.

## Spectrum Analyzer (Option 233 on Combination Analyzers) (continued)

### Frequency and time specifications (continued)

| Frequency Span                                  | Spec  |                       |
|---|---|-----------------------|
| Range   | 0 Hz (zero span), 10 Hz to maximum frequency range of instrument  |                       |
| Resolution                                      | 1 Hz  |                       |
| Accuracy  | ± (2 x RBW centering + horizontal resolution) for detector = Normal   |                       |
| Sweep time readout                              | Measured value of the time required to complete a sweep from start to finish, including time to tune receiver, acquire data, and process trace.                                     |                       |
| Trace update, nominal                           | N991xA, N993xA  | N995xA, N996xA        |
| Span = 20 MHz, RBW, VBW = 3 kHz                 | 6.7 updates per second <sup>1</sup>   | 8 updates per second  |
| Span = 100 MHz, RBW, VBW autocoupled            | 15.4 updates per second <sup>2</sup>  | 19 updates per second |
| Center frequency tune and transfer <sup>3</sup> | N991xA, N993xA <sup>4</sup>   | N995xA, N996xA        |
| 101 points, zero span                           | 70 ms   | 69 ms                 |
| 101 points, 1 MHz span                          | 72 ms   | 72 ms                 |
| Sweep time, zero span                           | Nominal   |                       |
| Range   | N991xA, N993xA: 1 µs to 1000 s<br>N995xA, N996xA: 1 µs to 6000 s  |                       |
| Resolution                                      | 100 ns  |                       |
| Readout   | Entered value representing trace horizontal scale range   |                       |
| Trigger (for zero span and FFT sweeps)          |   |                       |
| Trigger type                                    | Free run, external, video, RF burst, periodic   |                       |
| Trigger slope                                   | Positive edge, negative edge  |                       |
| Trigger delay                                   | Range: -150 ms to 10 s<br>Resolution: 100 ns  |                       |
| Auto trigger                                    | Forces a periodic acquisition in the absence of a trigger event<br>Range: 0 (off) to 30 s   |                       |
| Trigger position (zero span)                    | Controls horizontal position of the pulse edge; use sweep time to zoom into pulse edge<br>Range: 0 to 10, integer steps; 0 is left edge of graticule, 10 is right edge of graticule |                       |
| RF burst trigger                                | Nominal   |                       |
| Dynamic range                                   | 40 dB   |                       |
| Bandwidth                                       | 20 MHz  |                       |
| Operating frequency range                       | 20 MHz to maximum instrument frequency  |                       |
| Sweep (trace) point range                       |   |                       |
| All spans                                       | 101, 201, 401, 601, 801, 1001 (defaults to 401);<br>Arbitrary 2 to 20,001 settable through soft key "# Points" or SCPI  |                       |

<sup>1</sup> 1.2 updates per second; applicable to FieldFox units with serial number prefix ≤ MY5607/SG5607/US5607 and FieldFox units not upgraded with the fast CPU Option N9910HU-100/200/300.

<sup>2</sup> 4.1 updates per second; applicable to FieldFox units with serial number prefix ≤ MY5607/SG5607/US5607 and FieldFox units not upgraded with the fast CPU Option N9910HU-100/200/300.

<sup>3</sup> Within full frequency range of instrument, not band dependent.

<sup>4</sup> Applicable to FieldFox units with serial number prefix ≥ MY5607/SG5607/US5607 and FieldFox units that have been upgraded with the fast CPU Option N9910HU-100/200/300.

## Spectrum Analyzer (Option 233 on Combination Analyzers) (continued)

### Frequency and time specifications (continued)

| Resolution bandwidth (RBW)                | Nominal          |   |
|---|------------------|---|
| Range (-3 dB bandwidth)                   |                  |   |
| Zero span                                 | 10 Hz to 5 MHz   | 1, 3, 10 sequence   |
| Non-zero span                             | 1 Hz to 5 MHz    | 1, 1.5, 2, 3, 5, 7.5, 10 sequence < 300 kHz, 300 kHz, 1 MHz, 3 MHz, 5 MHz (Other RBWs may be set depending on settings) |
| Step keys change RBW in 1, 3, 10 sequence |                  |   |
| Selectivity (-60 dB / -3 dB)              | 4:1              |   |
| Bandwidth accuracy                        | Nominal          |   |
| Zero span                                 | 10 Hz to 1 MHz   | ± 5%  |
|   | 3 MHz            | ± 10%   |
|   | 5 MHz            | ± 15%   |
| Non-zero span                             | 1 Hz to 100 kHz  | ± 1%  |
|   | 300 kHz to 1 MHz | ± 5%  |
|   | 3 MHz            | ± 10%   |
|   | 5 MHz            | ± 15%   |
| Video bandwidth (VBW)                     | 1 Hz to 5 MHz    | 1, 1.5, 2, 3, 5, 7.5, 10 sequence   |

### Amplitude accuracy and range specifications

| Amplitude range         |  |   |
|-------------------------|--|---|
| Measurement range       | DANL to +20 dBm  |   |
| Input attenuator range  | 0 to 30 dB, in 5 dB steps                                      |   |
| Preamplifier            | Nominal  |   |
| Frequency range         | Full band (100 kHz to maximum frequency of instrument)         |   |
| Gain                    | N991xA, N993xA   | +20 dB, 100 kHz to 26.5 GHz                           |
|                         | N995xA, N996xA   | +20 dB, 100 kHz to 7.5 GHz<br>+15 dB, > 7.5 to 50 GHz |
| Max safe input level    | Average CW power   | DC  |
| N991xA, N993xA          | +27 dBm, 0.5 watts   | ± 50 VDC  |
| N991xA(with option V5K) | +27 dBm, 0.5 watts   | ± 40 VDC  |
| N995xA, N996xA          | +25 dBm, 0.3 watts   | ± 40 VDC  |
| Display range           |  |   |
| Log scale               | 10 divisions   |   |
|                         | 0.01 to 100 dB/division in 0.01 dB steps                       |   |
| Linear scale            | 10 divisions   |   |
| Scale units             | dBm, dBmV, dBµV, dBmA, dBµA, W, V, A, dBµV/m, dBµA/m, dBG, dBT |   |

## Spectrum Analyzer (continued)

### Amplitude accuracy and range specifications (continued)

| 50 MHz absolute amplitude accuracy (dB)  |                  |                     |                     |                        |
|--|------------------|---------------------|---------------------|------------------------|
| 10 dB attenuation, input signal 0 to -35 dBm, peak detector, preamplifier off, 300 Hz RBW, all settings auto-coupled. No warm-up required.   |                  |                     |                     |                        |
|  |                  | Spec (-10 to 55°C)  |                     | Typical (-10 to 55 °C) |
| N991xA, N993xA   |                  | ± 0.30              |                     | ± 0.10                 |
| 10 dB attenuation, input signal -5 to -35 dBm, peak detector, preamplifier off, 300 Hz RBW, all settings auto-coupled. No warm-up required.  |                  |                     |                     |                        |
|  |                  | Spec (-10 to 55°C)  |                     | Typical (-10 to 55 °C) |
| N995xA, N996xA   |                  | ± 0.60              |                     | ± 0.20                 |
| Total absolute amplitude accuracy (dB)   |                  |                     |                     |                        |
| 10 dB attenuation, input signal -15 to -5 dBm, peak detector, preamplifier off, 300 Hz RBW, all settings auto-coupled, includes frequency response uncertainties. No warm-up required. |                  |                     |                     |                        |
| N991xA, N993xA <sup>1,2</sup>  | Spec (23 ± 5 °C) | Spec (-10 to 55 °C) | Typical (23 ± 5 °C) | Typical (-10 to 55 °C) |
| 100 kHz to 18 GHz  | ± 0.80           | ± 1.00              | ± 0.35              | ± 0.50                 |
| > 18 to 26.5 GHz <sup>2</sup>  | ± 1.00           | ± 1.20              | ± 0.50              | ± 0.60                 |
| Total absolute amplitude accuracy (dB)   |                  |                     |                     |                        |
| 10 dB attenuation, input signal -15 to -5 dBm, peak detector, preamplifier off, 300 Hz RBW, all settings auto-coupled, includes frequency response uncertainties. No warm-up required. |                  |                     |                     |                        |
| N995xA, N996xA <sup>3</sup>  | Spec (23 ± 5 °C) | Spec (-10 to 55 °C) | Typical (23 ± 5 °C) | Typical (-10 to 55 °C) |
| 9 to 100 kHz   | ± 1.60           | ± 2.50              | ± 0.60              | ± 1.30                 |
| > 100 kHz to 2 MHz   | ± 1.30           | ± 1.90              | ± 0.60              | ± 0.80                 |
| > 2 to 15 MHz  | ± 1.00           | ± 1.20              | ± 0.30              | ± 0.50                 |
| > 15 MHz to 32 GHz   | ± 0.90           | ± 1.00 <sup>4</sup> | ± 0.30              | ± 0.50                 |
| > 32 to 40 GHz   | ± 1.10           | ± 1.60              | ± 0.50              | ± 0.70                 |
| > 40 to 43 GHz   | ± 1.50           | ± 2.20              | ± 0.50              | ± 0.70                 |
| > 43 to 50 GHz   | ± 1.60           | ± 2.90              | ± 0.50              | ± 0.90                 |
| Resolution bandwidth switching uncertainty   |                  | Nominal             |                     |                        |
| RBW < 5 MHz  |                  | 0.0 dB              |                     |                        |
| For signals not at center frequency  |                  | 0.7 dB peak-to-peak |                     |                        |

<sup>1</sup> 9 to 100 kHz: 0.4 dB (nominal) preamp on or off; applicable only for serial number with prefix of MY5607/SG5607/US5607 and FieldFox upgraded with Option N9910HU-100/200/300/400.

<sup>2</sup> N9938A units with Type-N connectors are tested using a system calibrated in 3.5 mm, with a precision 3.5 mm to Type-N adapter. With this adapter there are nominally four modes between 18 GHz and 26.5 GHz. The effect of these modes is included within these specifications.

<sup>3</sup> For N995xA and N996xA models, at frequencies > 300 kHz, absolute amplitude accuracy specifications apply to not only preamplifier off, but also preamplifier on.

<sup>4</sup> Increase by 0.3 dB between 18 and 32 GHz.

## Spectrum Analyzer (continued)

### Amplitude accuracy and range specifications (continued)

| RF input VSWR                         |  | Nominal |
|---------------------------------------|--|---------|
| N991xA, N993xA<br>(10 dB attenuation) | 10 MHz to 2.7 GHz  | 1.7 : 1 |
|                                       | > 2.7 to 7.5 GHz   | 1.5 : 1 |
|                                       | > 7.5 to 26.5 GHz  | 2.2 : 1 |
| N995xA, N996xA<br>(0 dB attenuation)  | 10 to 100 MHz  | 2.0 : 1 |
|                                       | > 100 to 500 MHz   | 1.7 : 1 |
|                                       | > 500 MHz to 17 GHz  | 1.5 : 1 |
|                                       | > 17 to 50 GHz   | 2.2 : 1 |
| Reference level                       |  |         |
| Range                                 | -210 to +90 dBm  |         |
| Traces                                |  |         |
| Detectors                             | Normal, positive peak, negative peak, sample, average (RMS)                        |         |
| States                                | Clear/write, max hold, min hold, average, view, blank                              |         |
|                                       | Number of averages: 1 to 10,001  |         |
| Number                                | 4: all four can be active simultaneously and in different states                   |         |
| Markers                               |  |         |
| Number of markers                     | 6  |         |
| Type                                  | Normal, delta, marker table  |         |
| Marker functions                      | Noise, band power, frequency counter   |         |
| Audio beep                            | Volume and tone change with signal strength  |         |
| Marker table                          | Display 6 markers  |         |
| Marker to →                           | Peak, next peak, peak left, peak right, center frequency, reference level, minimum |         |
|                                       | Tune frequency, for AM/FM tune and listen  |         |
| Marker properties                     | Peak criteria: peak excursion, peak threshold                                      |         |
|                                       | Delta reference fixed: Off or On   |         |
|                                       | Time zero fixed: Off or On   |         |

## Spectrum Analyzer (continued)

### Dynamic range specifications

| Displayed average noise level (DANL) - (dBm)  |                  |                     |                     |                        |
|---|------------------|---------------------|---------------------|------------------------|
| Input terminated, RMS detection, log averaging, 0 dB input attenuation, reference level of -20 dBm, normalized to 1 Hz RBW, measured at non-zero frequency span |                  |                     |                     |                        |
| N991xA, N993xA <sup>1</sup>   |                  |                     |                     |                        |
| Preamp off  | Spec (23 ± 5 °C) | Spec (-10 to 55 °C) | Typical (23 ± 5 °C) | Typical (-10 to 55 °C) |
| 2 MHz to 4.5 GHz <sup>2</sup>   | -137             | -135                | -139                | -138                   |
| > 4.5 to 7 GHz  | -133             | -131                | -136                | -130                   |
| > 7 to 13 GHz   | -129             | -127                | -132                | -130                   |
| > 13 to 17 GHz  | -124             | -122                | -126                | -125                   |
| > 17 to 22 GHz  | -119             | -117                | -122                | -121                   |
| > 22 to 25 GHz  | -114             | -111                | -117                | -114                   |
| > 25 to 26.5 GHz  | -110             | -108                | -112                | -111                   |
| Preamp on   | Spec (23 ± 5 °C) | Spec (-10 to 55 °C) | Typical (23 ± 5 °C) | Typical (-10 to 55 °C) |
| 2 MHz to 4.5 GHz <sup>2</sup>   | -153             | -151                | -155                | -154                   |
| > 4.5 to 7 GHz  | -149             | -147                | -151                | -150                   |
| > 7 to 13 GHz   | -147             | -145                | -149                | -148                   |
| > 13 to 17 GHz  | -143             | -141                | -145                | -144                   |
| > 17 to 22 GHz  | -140             | -139                | -143                | -142                   |
| > 22 to 25 GHz  | -134             | -132                | -137                | -134                   |
| > 25 to 26.5 GHz  | -128             | -126                | -131                | -129                   |
| N995xA, N996xA  |                  |                     |                     |                        |
| Preamp off  | Spec (23 ± 5 °C) | Spec (-10 to 55 °C) | Typical (23 ± 5 °C) | Typical (-10 to 55 °C) |
| 9 kHz to 2 MHz  | -91              | -91                 | -118                | -118                   |
| > 2 MHz to 2.1 GHz  | -137             | -135                | -143                | -141                   |
| > 2.1 to 2.8 GHz  | -135             | -133                | -142                | -140                   |
| > 2.8 to 4.5 GHz  | -137             | -135                | -143                | -141                   |
| > 4.5 to 7 GHz  | -134             | -133                | -140                | -138                   |
| > 7 to 13 GHz   | -134             | -132                | -141                | -139                   |
| > 13 to 22 GHz  | -132             | -129                | -140                | -137                   |
| > 22 to 35 GHz  | -130             | -127                | -137                | -134                   |
| > 35 to 40 GHz  | -122             | -119                | -132                | -129                   |
| > 40 to 46 GHz  | -119             | -116                | -126                | -123                   |
| > 46 to 50 GHz  | -117             | -112                | -124                | -120                   |

<sup>1</sup> 9 kHz to 2 MHz: -116 (nominal) preamp off, -120 (nominal) preamp on, applicable only for FieldFox units with serial number prefixes of MY5607/SG5607/US5607 and FieldFox units upgraded with Option N9910HU-100/200/300/400.

<sup>2</sup> Add 4 dB between 2.1 and 2.8 GHz.

## Spectrum Analyzer (continued)

### Dynamic range specifications (continued)

| N995xA, N996xA     |                  |                     |                     |                        |
|--------------------|------------------|---------------------|---------------------|------------------------|
| Preamp on          | Spec (23 ± 5 °C) | Spec (-10 to 55 °C) | Typical (23 ± 5 °C) | Typical (-10 to 55 °C) |
| 9 kHz to 2 MHz     | -94              | -94                 | -131                | -130                   |
| > 2 MHz to 2.1 GHz | -153             | -151                | -159                | -158                   |
| > 2.1 to 2.8 GHz   | -151             | -149                | -157                | -155                   |
| > 2.8 to 4.5 GHz   | -153             | -151                | -158                | -156                   |
| > 4.5 to 7 GHz     | -150             | -149                | -156                | -154                   |
| > 7 to 13 GHz      | -146             | -144                | -152                | -150                   |
| > 13 to 22 GHz     | -142             | -139                | -149                | -147                   |
| > 22 to 35 GHz     | -141             | -139                | -147                | -145                   |
| > 35 to 40 GHz     | -136             | -132                | -144                | -141                   |
| > 40 to 46 GHz     | -131             | -128                | -138                | -135                   |
| > 46 to 50 GHz     | -126             | -123                | -135                | -132                   |

| Residual responses (dBm)                      | Nominal        |                |
|---|----------------|----------------|
|   | N991xA, N993xA | N995xA, N996xA |
| Input terminated preamp off, 0 dB attenuation |                |                |
| 100 kHz to 10 MHz                             | -90            | —              |
| > 10 MHz to 13 GHz                            | -110           | —              |
| > 13 GHz to 20 GHz                            | -90            | —              |
| > 20 GHz to 26.5 GHz                          | -80            | —              |
| 100 kHz to 10 MHz                             | —              | -90            |
| > 10 MHz to 1 GHz <sup>1</sup>                | —              | -110           |
| > 1 GHz to 32 GHz <sup>2</sup>                | —              | -100           |
| > 32 GHz to 50 GHz                            | —              | -95            |

| Input related responses (dBc)                                     | Nominal        |                |
|---|----------------|----------------|
|   | N991xA, N993xA | N995xA, N996xA |
| -30 dBm signal at mixer input (excludes frequencies listed below) | -80            | -80            |
| f = center frequency  |                |                |
| < 2.6 GHz, f + 2 x 33.75 MHz                                      | -80            | -80            |
| < 2.6 GHz, f - 2 x 866.25 MHz                                     | -80            | -80            |
| < 2.6 GHz, f + 2 x 3.63375 GHz                                    | -85            | -90            |
| ≥ 2.6 to 7.5 GHz, f + 2 x 33.75 MHz                               | -80            | -80            |
| ≥ 2.6 to 7.5 GHz, f + 2 x 866.25 MHz                              | -80            | -80            |
| ≥ 2.6 to 7.5 GHz, f + 2 x 9.86625 GHz                             | -80            | -85            |
| ≥ 7.5 to 16.3 GHz, f + 2 x 3.63375 GHz                            | -65            | -65            |
| ≥ 16.3 to 26.5 GHz, f - 2 x 3.63375 GHz                           | -60            | —              |
| ≥ 7.5 to 26.5 GHz, f + 2 x 33.75 MHz                              | -80            | —              |
| ≥ 7.5 to 26.5 GHz, f - 2 x 866.25 MHz                             | -80            | —              |
| ≥ 16.3 to 23 GHz, f - 2 x 3.63375 GHz                             | —              | -60            |
| ≥ 23 to 32.5 GHz, f + 2 x 3.63375 GHz                             | —              | -65            |
| ≥ 32.5 to 43 GHz, f - 2 x 3.63375 GHz                             | —              | -55            |
| ≥ 7.5 to 50 GHz, f - 2 x 866.25 MHz                               | —              | -80            |
| ≥ 7.5 to 50 GHz, f + 2 x 33.75 MHz                                | —              | -80            |

<sup>1</sup> Excludes 90 MHz @ -95 dBm.

<sup>2</sup> Excludes 25.43 GHz @ -90 dBm.

## Spectrum Analyzer (continued)

### Dynamic range specifications (continued)

| Other spurious responses (dBc)                                       |                | Nominal                 |  |
|--|----------------|-------------------------|--|
|  | N991xA, N993xA | N995xA, N996xA          |  |
| LO related spurs   | -60            | -60                     |  |
| Sideband   | -80            | -80                     |  |
| Second harmonic distortion (dBc)                                     |                | Nominal                 |  |
| -30 dBm signal at mixer input  |                | N991xA, N993xA          |  |
| ≤ 1.3 GHz <sup>1</sup>   | —              | < -75                   |  |
| > 1.3 GHz  | —              | < -60                   |  |
| ≤ 4 GHz <sup>1</sup>   | < -60          | —                       |  |
| > 4 GHz  | < -80          | —                       |  |
| Third order intermodulation distortion (TOI) – (dBm)                 |                | Typical                 |  |
| Two -15 dBm signals, 100 kHz spacing at mixer input (-10 to 55 °C)   |                |                         |  |
| N991xA, N993xA   |                | < 1 GHz, +10            |  |
|  |                | 1 to 7.5 GHz, +15       |  |
|  |                | > 7.5 GHz, +21          |  |
| N995xA, N996xA   |                | 50 to 500 MHz, +9.5     |  |
|  |                | > 500 MHz to 1 GHz, +13 |  |
|  |                | > 1 to 2.4 GHz, +16     |  |
|  |                | > 2.4 to 2.6 GHz, +12   |  |
|  |                | > 2.6 GHz, +13          |  |
| Spur free dynamic range (dB) at 2.4 GHz 2/3 (TOI – DANL) in 1 Hz RBW |                | Nominal                 |  |
| N991xA, N993xA   |                | >105                    |  |
| N995xA, N996xA   |                | >104                    |  |

<sup>1</sup> Applies to frequencies > 15 MHz



## Distortion and noise limited (10 Hz RBW) dynamic range (nominal)

Applies to N991xA and N993xA

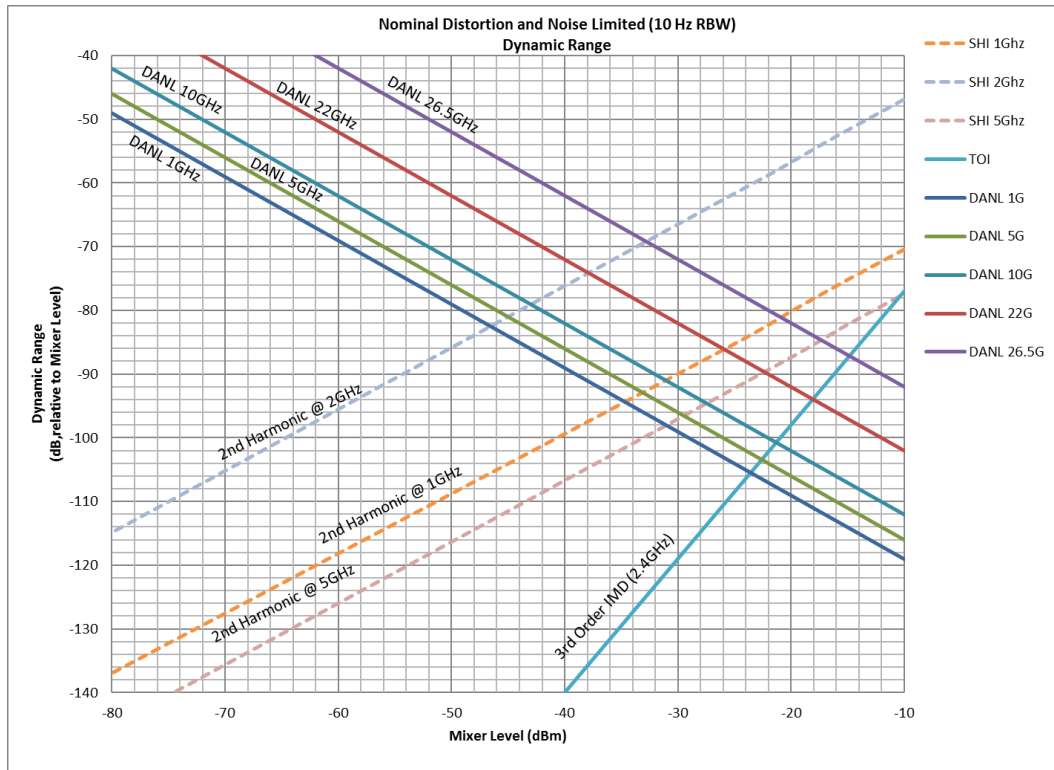

Applies to N995xA and N996xA

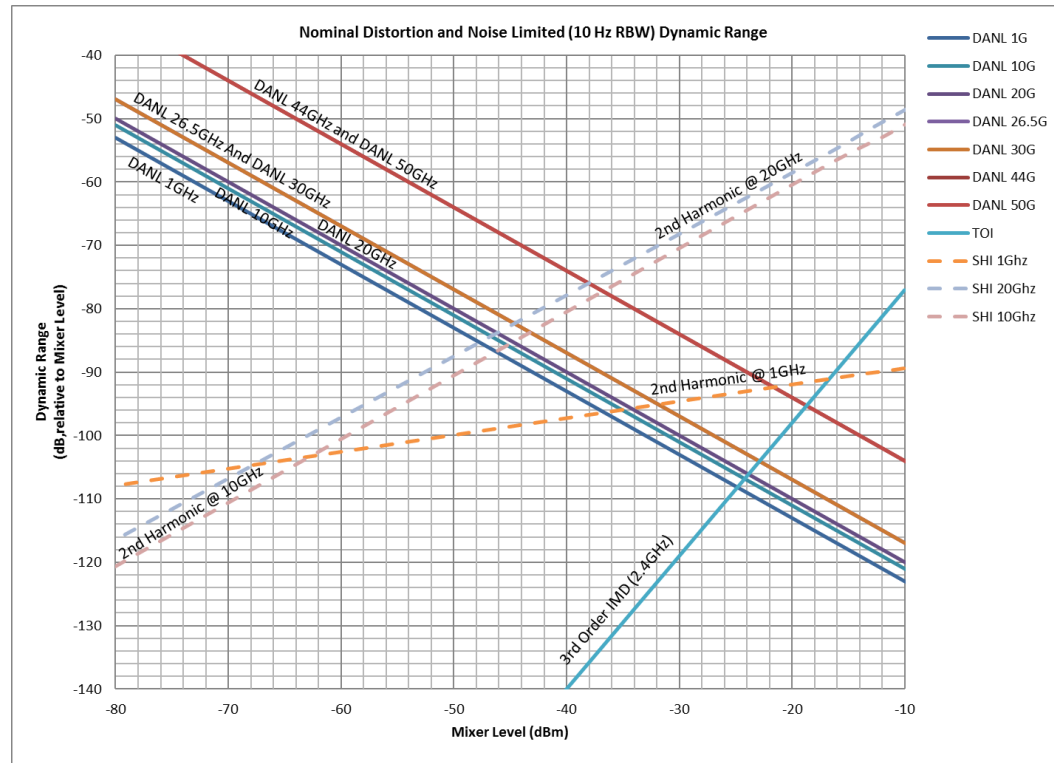

## Spectrum Analyzer (continued)

### SSB phase noise at 1 GHz center frequency

| Phase noise (dBc/Hz) | SSB phase noise at 1 GHz (N991xA, N993xA, N995xA, N996xA) |                     |                     |                        |
|----------------------|---|---------------------|---------------------|------------------------|
| Offset               | Spec (23 ± 5 °C)  | Spec (-10 to 55 °C) | Typical (23 ± 5 °C) | Typical (-10 to 55 °C) |
| 10 kHz               | -106  | -106                | -111                | -111                   |
| 30 kHz               | -106  | -104                | -110                | -108                   |
| 100 kHz              | -100  | -99                 | -105                | -104                   |
| 1 MHz                | -110  | -110                | -113                | -113                   |
| 3 MHz                | -119  | -118                | -122                | -122                   |
| 5 MHz                | -120  | -120                | -123                | -123                   |

### Phase noise at different center frequencies (nominal)

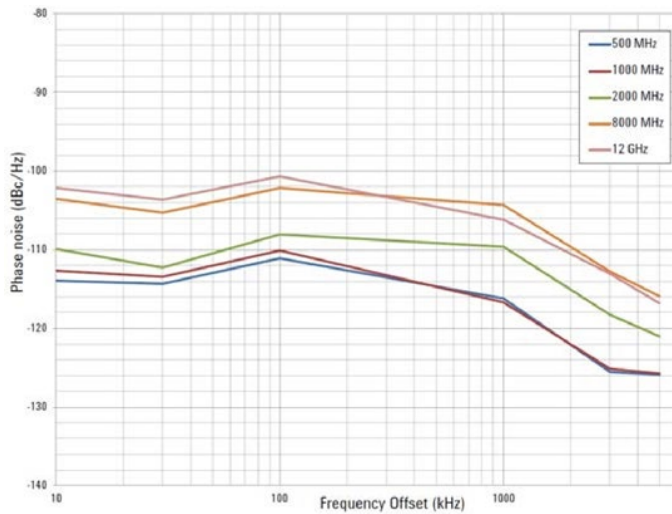

### Dynamic range versus offset frequency versus RBW (nominal)

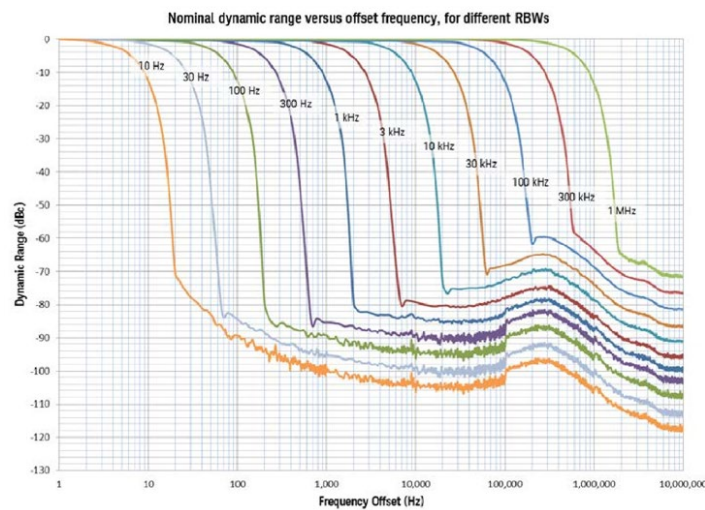

## Tracking Generator or Independent Source

(See Configuration Guide for option information)

The performance listed in this section applies to the tracking generator and independent source capabilities available in the following models:

|  |  |
|--|--|
| FieldFox RF & microwave (combination) analyzers: | N9913A, N9914A, N9915A, N9916A, N9917A, N9918A<br>N9950A, N9951A, N9952A |
| FieldFox microwave spectrum analyzers:           | N9935A, N9936A, N9937A, N9938A<br>N9960A, N9961A, N9962A                 |

See [FieldFox Configuration Guide](#) for option information. Many capabilities listed in this Data Sheet require options.

Note: Traditional tracking generators track the receiver frequency only. In FieldFox analyzers, the tracking generator frequency can be set to either track the receiver frequency, or act as an independent CW source.

|                        | Models   | Tracking generator or independent source frequency range |
|------------------------|--|--|
| N991xA, N993xA         | 9913A  | 30 kHz to 4 GHz  |
|                        | 9914A  | 30 kHz to 6.5 GHz  |
|                        | 9915A, N9935A  | 30 kHz to 9 GHz  |
|                        | 9916A, N9936A  | 30 kHz to 14 GHz   |
|                        | 9917A, N9937A  | 30 kHz to 18 GHz   |
|                        | 9918A, N9938A  | 30 kHz to 26.5 GHz                                       |
| N995xA, N996xA         | 9950A, N9960A  | 300 kHz to 32 GHz  |
|                        | 9951A, N9961A  | 300 kHz to 44 GHz  |
|                        | 9952A, N9962A  | 300 kHz to 50 GHz  |
| <b>Power step size</b> |  |  |
|                        | Power settable in 1 dB steps across power range              |  |
| <b>Functions</b>       |  |  |
| Mode                   | Continuous wave (CW), CW coupled, tracking (swept frequency) |  |
| Operations             | Normalization, frequency offset, spectral reversal           |  |

## Tracking Generator or Independent Source (continued)

| Output power (dBm) | Frequency          | Typical                              | Nominal              |
|--------------------|--------------------|--------------------------------------|----------------------|
| N991xA, N993xA     | 30 to 300 kHz      | -11                                  | —                    |
|                    | > 300 kHz to 2 MHz | -3                                   | -2                   |
|                    | > 2 to 625 MHz     | -2                                   | -1                   |
|                    | > 625 MHz to 3 GHz | 1                                    | 3                    |
|                    | > 3 to 6.5 GHz     | -1                                   | 1                    |
|                    | > 6.5 to 9 GHz     | -2                                   | 0                    |
|                    | > 9 to 14 GHz      | -4                                   | -2.5                 |
|                    | > 14 to 18 GHz     | -6                                   | -4.5                 |
|                    | > 18 to 23 GHz     | -10                                  | -8.5                 |
|                    | > 23 to 26.5 GHz   | -12                                  | -11                  |
| N995xA, N996xA     | 300 to 500 kHz     | —                                    | -9                   |
|                    | > 500 kHz to 2 MHz | -1                                   | —                    |
|                    | > 2 MHz to 1 GHz   | 2                                    | —                    |
|                    | > 1 to 6.5 GHz     | 2                                    | —                    |
|                    | > 6.5 to 18 GHz    | 4                                    | —                    |
|                    | > 18 to 26.5 GHz   | 2                                    | —                    |
|                    | > 26.5 to 39 GHz   | 1                                    | —                    |
|                    | > 39 to 44 GHz     | -1                                   | —                    |
|                    | > 44 to 46 GHz     | -2                                   | —                    |
|                    | > 46 to 50 GHz     | -4                                   | —                    |
| Dynamic range (dB) | Frequency          | Typical (-10 to 55 °C)<br>Preamp off | Nominal<br>Preamp on |
| N991xA, N993xA     | 2 MHz to 2 GHz     | 97                                   | 112                  |
|                    | > 2 to 7 GHz       | 93                                   | 108                  |
|                    | > 7 to 11 GHz      | 88                                   | 103                  |
|                    | > 11 to 16 GHz     | 79                                   | 95                   |
|                    | > 16 to 21 GHz     | 71                                   | 86                   |
|                    | > 21 to 23 GHz     | 55                                   | 70                   |
|                    | > 23 to 25 GHz     | 50                                   | 65                   |
|                    | > 25 to 26.5 GHz   | 45                                   | 60                   |
| N995xA, N996xA     | 500 kHz to 2 MHz   | 79                                   | 100                  |
|                    | > 2 MHz to 2.1 GHz | 101                                  | 115                  |
|                    | > 2.1 to 2.8 GHz   | 99                                   | 112                  |
|                    | > 2.8 to 4.5 GHz   | 101                                  | 115                  |
|                    | > 4.5 to 10 GHz    | 99                                   | 105                  |
|                    | > 10 to 18 GHz     | 88                                   | 95                   |
|                    | > 18 to 37 GHz     | 85                                   | 90                   |
|                    | > 37 to 40 GHz     | 77                                   | 82                   |
| > 40 to 43 GHz     | 65                 | 80                                   |                      |
| > 43 to 50 GHz     | 73                 | 76                                   |                      |

## Real-Time Spectrum Analyzer (RTSA) (Option 350)

The performance listed in this section applies to the real-time spectrum analyzer capabilities available in the following models:

|  |  |
|--|--|
| FieldFox RF & microwave (combination) analyzers: | N9913A, N9914A, N9915A, N9916A, N9917A, N9918A<br>N9950A, N9951A, N9952A |
| FieldFox microwave spectrum analyzers:           | N9935A, N9936A, N9937A, N9938A<br>N9960A, N9961A, N9962A                 |

See [FieldFox Configuration Guide](#) for option information. Many capabilities listed in this data sheet require options.

|                | Models         | Real-time analysis frequency range <sup>1</sup> |                 |
|----------------|----------------|---|-----------------|
| N991xA, N993xA | N9913A         | 1 MHz to 4 GHz                                  | Usable to 5 kHz |
|                | N9914A         | 1 MHz to 6.5 GHz                                | Usable to 5 kHz |
|                | N9915A, N9935A | 1 MHz to 9 GHz                                  | Usable to 5 kHz |
|                | N9916A, N9936A | 1 MHz to 14 GHz                                 | Usable to 5 kHz |
|                | N9917A, N9937A | 1 MHz to 18 GHz                                 | Usable to 5 kHz |
|                | N9918A, N9938A | 1 MHz to 26.5 GHz                               | Usable to 5 kHz |
| N995xA, N996xA | N9950A, N9960A | 1 MHz to 32 GHz                                 | Usable to 5 kHz |
|                | N9951A, N9961A | 1 MHz to 44 GHz                                 | Usable to 5 kHz |
|                | N9952A, N9962A | 1 MHz to 50 GHz                                 | Usable to 5 kHz |

| Real-time analysis  |  |  |
|---|--|--|
| Maximum real-time bandwidth   | 10 MHz   |  |
| Measurements  | Density Spectrum, Spectrogram, Real-time Spectrum                |  |
| Resolution bandwidth  | 1 Hz to 500 kHz  | Span dependent, $20 \leq \text{Span}/\text{RBW} \leq 280$ . Default is 35.7 kHz  |
| Minimum signal duration with 100% probability of intercept (POI) at full amplitude accuracy | 12.2 $\mu$ s   | At 10 MHz span, 500 kHz RBW  |
| Minimum detectable signal   | 22 ns  | Minimum detectable pulse width is the shortest pulse width of a pulsed CW signal that will display a peak amplitude that is no worse than 60 dB below the peak amplitude of a CW signal of the same power level for a 10 MHz span and auto-coupled RBW |
| Spurious-free dynamic range across maximum BW   | 63 dB  |  |
| FFT rate  | 120,000 FFT/s  | At 10 MHz span   |
| IF flatness (typical)   | $\pm 0.2$ dB $\leq 26.5$ GHz,                                    | $\pm 0.3$ dB $> 26.5$ GHz  |
| Number of display points  | 561  |  |
| Min. acquisition time   | 20 ms  | At 10 MHz span   |
| Max. acquisition time   | 500 ms   | At 10 MHz span   |
| Traces  |  |  |
| Number of traces  | 4: all four can be active simultaneously and in different states |  |
| Detectors   | Normal, positive peak, negative peak, sample, average (RMS)      |  |
| States  | Clear/write, max. hold, min. hold, average, view, blank          |  |

<sup>1</sup> Performance specified above 1 MHz. Usable down to 5 kHz.

## RTSA (continued)

| Markers           |  |
|-------------------|--|
| Number of markers | 6  |
| Type              | Normal, delta, peak                                |
| Marker →          | Peak, next peak, center frequency, reference level |
| Trigger           |  |
| Trigger type      | Free run, external, video, RF burst, periodic      |

## I/Q Analyzer (IQA) (Option 351)

The specifications in this section apply to the I/Q analyzer capabilities available in the following models:

|  |  |
|--|--|
| FieldFox RF & microwave (combination) analyzers: | N9913A, N9914A, N9915A, N9916A, N9917A, N9918A, N9950A, N9951A, N9952A |
| FieldFox microwave spectrum analyzers:           | N9935A, N9936A, N9937A, N9938A, N9960A, N9961A, N9962A                 |

See [FieldFox Configuration Guide](#) for option information. Many capabilities listed in this Data Sheet require options.

|              | Models         | I/Q analysis frequency range <sup>1</sup> |
|--------------|----------------|---|
| N991x, N993x | N9913A         | 1 MHz to 4 GHz                            |
|              | N9914A         | 1 MHz to 6.5 GHz                          |
|              | N9915A, N9935A | 1 MHz to 9 GHz                            |
|              | N9916A, N9936A | 1 MHz to 14 GHz                           |
|              | N9917A, N9937A | 1 MHz to 18 GHz                           |
|              | N9918A, N9938A | 1 MHz to 26.5 GHz                         |
| N995x, N996x | N9950A, N9960A | 1 MHz to 32 GHz                           |
|              | N9951A, N9961A | 1 MHz to 44 GHz                           |
|              | N9952A, N9962A | 1 MHz to 50 GHz                           |

| Measurements                |   |
|-----------------------------|---|
| Spectrum (frequency domain) | Magnitude spectrum  |
| Waveform (time domain)      | RF envelope   |
|                             | I/Q waveform (Dual simultaneous top and bottom windows: I vs. time and Q vs. time)  |
| Display (multi-domain)      |   |
| User Defined                | User can set up and display up to 4 simultaneous and multi-domain measurements with any combination of the following: <ul style="list-style-type: none"> <li>Frequency domain: Magnitude spectrum</li> <li>Time domain: RF envelope, Q vs. I (polar plot), Phase vs. time, Unwrapped phase vs. time, I vs. time, Q vs. time</li> <li>Time summary table showing I/Q capture settings: I/Q capture time, waveform start/stop, Spectrum FFT time</li> </ul> |
| Measurement Setup           |   |
| I/Q capture parameters      | Capture time, sample rate, sample period, capture samples   |

<sup>1</sup> Performance specified above 1 MHz. Usable down to 5 kHz.

## IQA (continued)

| <b>Frequency</b>  |   |  |  |
|---|---|--|--|
| Frequency span  |   |  |  |
| <b>Resolution bandwidth (spectrum measurement)</b>                          |   |  |  |
| Range   |   |  |  |
| Overall   | 200 mHz to 3 MHz  | 1, 1.5, 2, 3, 5, 7.5, 10 sequence; arbitrary RBW settable via front panel and SCPI |  |
| 10 MHz span   | 90 Hz to 3 MHz  | FFT window flat top (default)  |  |
| FFT window shapes   | Flat Top (multiple), Uniform, Triangular, Hanning, Hamming, Gaussian (multiple), Blackman, Blackman-Harris (multiple), Kaiser Bessel (multiple), Others |  |  |
| <b>Model</b>  | <b>N9913 /14 /15 /16 /17 /18A<br/>N9935 /36 /37 /38A Typical<sup>1</sup></b>  |  | <b>N9950 /51 /52A<br/>N9960 /61 /62A Typical<sup>1</sup></b> |
| Maximum bandwidth   | 10 MHz  |  | 10 MHz   |
| IF flatness   | Magnitude   | $\pm 0.2$ dB   |  |
|   |   | Phase deviation from linearity <sup>2</sup>  | 2.3° peak-to-peak, 1.6° rms    2.6° peak-to-peak, 1.8° rms   |
|   |   | Group delay flatness (peak-to-peak) <sup>2</sup>                                   | 11 ns  |
| EVM (at center frequency 1 GHz)   | LTE-A FDD TM3.1 (10 MHz)  | 0.8%   | 0.7%   |
|   | WCDMA TM4 (5 MHz)   | 0.8%   | 0.85%  |
| EVM (at center frequency 2.1 GHz)   | LTE-A FDD TM3.1 (10 MHz)  | 1%   | 1.1%   |
|   | WCDMA TM4 (5 MHz)   | 1.1%   | 1.2%   |
| <b>Spur free dynamic range (dB) at 2.4 GHz 2/3 (TOI - DANL) in 1 Hz RBW</b> |   | <b>Nominal</b>   |  |
| N991xA, N993xA  |   | > 105  |  |
| N995xA, N996xA  |   | > 104  |  |
| <b>Data acquisition (standard 10 MHz IF path)</b>                           |   |  |  |
| Total capture memory  | 32 MB   |  |  |
| Length single I/Q capture   | 8 bytes/sample  |  |  |
| Maximum length I/Q capture  | 4 MSa   |  |  |
| Sample rate (I/Q pairs)   | 1.25 x span, Maximum 12.5 MHz   |  |  |
| Length (time units)   | (Captured samples - 1)/Sample rate (I/Q pairs)  |  |  |
| ADC resolution  | 14 bits   |  |  |
| <b>Maximum I/Q capture time</b>   |   |  |  |
| 10 MHz IFBW   | 320 ms  |  |  |
| 1 MHz IFBW  | 3.2 s   |  |  |
| 100 kHz IFBW  | 32 s  |  |  |
| 10 kHz IFBW   | 320 s   |  |  |
| <b>Traces</b>   |   |  |  |
| Number of windows and layout  | 1, 2 (top & bottom), 3 (one top, two bottom), or 4 (quad display)   |  |  |
| Number of traces  | 4, all four traces can be active simultaneously in all windows  |  |  |
| States  | Clear/write, max hold, min hold, average, view, blank   |  |  |

<sup>1</sup> These numbers were generated from room temperature results (23 °C).

<sup>2</sup> Not guaranteed below 50 MHz

## IQA (continued)

| Markers                     |   |
|-----------------------------|---|
| Number of markers           | 6 normal + delta pairs  |
| Type                        | Normal, delta, peak, marker table (up to 6 markers)                                       |
| Couple markers              | On/off (couple markers between traces in different windows)                               |
| Marker →                    | Peak, next peak, center frequency, reference level  |
| Trigger                     |   |
| Trigger type                | Free run, external, video, RF burst   |
| Trigger slope               | Positive edge, negative edge  |
| Trigger delay               | Range: -150 ms to 500 ms<br>Resolution: 100 ns  |
| Auto trigger                | Forces a periodic acquisition in the absence of a trigger event<br>Range: 0 (off) to 30 s |
| Data Storage                |   |
| Data types                  | Trace, Trace+state, picture (PNG)   |
| I/Q capture data file types | CSV, text (TXT), SDF (compatible with 89600 VSA software), Matlab (MAT)                   |
| I/Q data formats via SCPI   | Raw binary interleaved I/Q data recording, REAL32 (ASCII is default)                      |

## Noise Figure (NF) (Option 356)

The specifications in this section apply to the noise figure measurement capabilities available in the following models:

|  |  |
|--|--|
| FieldFox RF & microwave (combination) analyzers: | N9913A, N9914A, N9915A, N9916A, N9917A, N9918A<br>N9950A, N9951A, N9952A |
| FieldFox microwave spectrum analyzers:           | N9935A, N9936A, N9937A, N9938A<br>N9960A, N9961A, N9962A                 |

See [FieldFox Configuration Guide](#) for option information. Many capabilities listed in this Data Sheet require options.

No warm-up is required for the instrument specifications.

|              | Models         | Noise figure analysis frequency range |
|--------------|----------------|---------------------------------------|
| N991x, N993x | N9913A         | 10 MHz to 4 GHz                       |
|              | N9914A         | 10 MHz to 6.5 GHz                     |
|              | N9915A, N9935A | 10 MHz to 9 GHz                       |
|              | N9916A, N9936A | 10 MHz to 14 GHz                      |
|              | N9917A, N9937A | 10 MHz to 18 GHz                      |
|              | N9918A, N9938A | 10 MHz to 26.5 GHz                    |
| N995x, N996x | N9950A, N9960A | 10 MHz to 32 GHz                      |
|              | N9951A, N9961A | 10 MHz to 44 GHz                      |
|              | N9952A, N9962A | 10 MHz to 50 GHz                      |



## NF (continued)

| Measurements                              |  |                          |   |
|---|--|--------------------------|---|
| Noise figure                              | Noise figure (F dB)  |                          |   |
| Noise factor                              | Noise figure as a ratio (F)                                  |                          |   |
| Gain                                      | Gain (G dB)  |                          |   |
| Noise temperature                         | Noise temperature in Kelvin (K)                              |                          |   |
| Y-factor                                  | Y-factor (Y dB)  |                          |   |
| Setup parameters                          |  | Supplemental information |   |
| Noise source                              |  |                          | Load ENR value(s)   |
| DUT type                                  | Amplifier, Downconverter, Upconverter, Multi-stage Converter |                          | Built-in GUI wizard aids DUT measurement setup  |
| Integration                               | Mode   | Auto                     | Auto Integration: optimizes gain to avoid compression, and measurement time to achieve jitter goal  |
|   |  | Fixed                    | Fixed Integration: the time per point over which the measurement is averaged is fixed   |
|   | Jitter goal  |                          | Sets measurement jitter performance target  |
|   | Max time / point   |                          | Allows user to trade-off jitter vs. measurement time  |
|   | Jitter warning   |                          | On: displays circles on trace data if jitter goal is exceeded<br>Off (default): disables trace circle indicators  |
| Loss compensation                         | Before DUT, After DUT  |                          | User definable, compensates measurement for loss (dB) before and after DUT  |
| Measurement bandwidth (nominal)           |  |                          |   |
| Range                                     | 5 MHz (default), 2 MHz, 1 MHz, 300 kHz                       |                          |   |
| Frequency reference                       |  |                          |   |
| Refer to spectrum analyzer specifications |  |                          |   |
| Noise figure uncertainty calculator       |  |                          | Supplemental information  |
|   |  |                          | Built-in<br>Based on data from measurement  |
| DUT                                       | Mode   | Spot                     | Applies single values uniformly across frequency: Input $ \Gamma $ and Output $ \Gamma $<br>$\Gamma$ specification style: Maximum, 95th percentile, 80th percentile, Median, Mean, Fixed<br>$\Gamma$ distribution: Rayleigh, Fixed, Uniform in Circle |
|   |  | Table                    | Applies a table of values vs. frequency: Input $ \Gamma $ and Output $ \Gamma $<br>$\Gamma$ specification style: Maximum, 95th percentile, 80th percentile, Median, Mean, Fixed<br>$\Gamma$ distribution: Rayleigh, Fixed, Uniform in Circle          |
| Preamplifier                              | Mode   | Spot                     | Applies single values uniformly across frequency Input $ \Gamma $ and Output $ \Gamma $<br>$\Gamma$ specification style: Maximum, 95th percentile, 80th percentile, Median, Mean, Fixed<br>$\Gamma$ distribution: Rayleigh, Fixed, Uniform in Circle  |
|   |  | Table                    | Applies a table of values vs. frequency: Input $ \Gamma $ and Output $ \Gamma $<br>$\Gamma$ specification style: Maximum, 95th percentile, 80th percentile, Median, Mean, Fixed<br>$\Gamma$ distribution: Rayleigh, Fixed, Uniform in Circle          |

## NF (continued)

| Noise figure uncertainty calculator                                  |                  | Supplemental information  |
|--|------------------|---|
|  |                  | Built-in<br>Based on data from measurement  |
| Noise source   | ENR Mode         | Spot<br>Applies single values uniformly across frequency: ENR (dB), ENR Uncertainty (dB), On $ \Gamma $ , Off $ \Gamma $ , ENR Uncertainty Confidence (SD)<br>$\Gamma$ specification style: Maximum, 95th percentile, 80th percentile, Median, Mean, Fixed<br>$\Gamma$ distribution: Rayleigh, Fixed, Uniform in Circle   |
|  |                  | Table<br>Applies a table of values vs. frequency: ENR (dB), ENR Uncertainty (dB), On $ \Gamma $ , Off $ \Gamma $ , ENR Uncertainty Confidence (SD)<br>$\Gamma$ specification style: Maximum, 95th percentile, 80th percentile, Median, Mean, Fixed<br>$\Gamma$ distribution: Rayleigh, Fixed, Uniform in Circle   |
|  |                  | Smart <sup>1</sup> (Auto)<br>For U183x USB smart noise sources (SNS) only. When connected with a USB SNS, FieldFox automatically downloads the ENR table data from the SNS and applies a table of values vs. frequency: ENR (dB), ENR Uncertainty (dB), On $ \Gamma $ , Off $ \Gamma $ , ENR Uncertainty Confidence (SD)<br>$\Gamma$ specification style: Maximum, 95th percentile, 80th percentile, Median, Mean, Fixed<br>$\Gamma$ distribution: Rayleigh, Fixed, Uniform in Circle |
| Uncertainty contributions  | Jitter           | Random independent events (fluctuations) within the bandwidth occurring during the noise measurement  |
|  | ENR              | Excess noise ratio of the hot noise source connected to the DUT during the measurement  |
|  | Mismatch         | Errors resulting from reflections due to impedance differences between components   |
|  | User calibration | Errors due to the optional user calibration which is performed with a defined noise standard (ENR source) connected to the input of an LNA, and fixturing/cables used in the DUT measurement, and port 2 of the FieldFox  |
| Uncertainty coverage   |                  | User settable, uncertainty coverage can be set to $1\sigma$ (80%), $2\sigma$ (95% default), $3\sigma$ (99.5%)   |
| Uncertainty bars   |                  | Displays vertical bars representing the calculated measurement uncertainty overlaid on the trace data   |
| Loss compensation  | Before DUT       | User definable, single value, compensates measurement for insertion loss (dB) before DUT  |
|  | After DUT        | User definable, single value, compensates measurement for loss (dB) after DUT   |
| Instrument match   |                  | VSWR values are preloaded and automatically applied for instrument and U7227A/C/F or U7228A/C/F preamplifiers   |
| <b>Calibration options</b>   |                  |   |
| Receiver calibration   |                  | Uses noise source to calibrate FieldFox receiver gain bandwidth   |
| User calibration with external U7227A/C/F or U7228A/C/F preamplifier |                  | Optional calibration performs hot/cold measurement with external preamplifier; applies receiver and user calibrations   |

<sup>1</sup> Requires FieldFox firmware rev. A. 12.53 or later

## NF (continued)

| Noise figure <sup>1</sup> |                      |                               |  |  |
|---------------------------|----------------------|-------------------------------|--|--|
| Model                     | Frequency            | Internal preamplifier ON (dB) | Internal preamplifier ON + U7227/8A (dB) | Internal preamplifier ON + U7227/8C (dB) |
| N991xA, N993xA            | 10 to 100 MHz        | 22.5                          | 9.0                                      | —  |
|                           | > 100 MHz to 4 GHz   | 22.5                          | 8.2                                      | 9.2                                      |
|                           | > 4 to 4.5 GHz       | 22.5                          | —  | 8.2                                      |
|                           | > 4.5 to 6 GHz       | 26.5                          | —  | 10.6                                     |
|                           | > 6 to 7 GHz         | 26.5                          | —  | 10.1                                     |
|                           | > 7 to 13 GHz        | 28.5                          | —  | 11.4                                     |
|                           | > 13 to 17 GHz       | 32.5                          | —  | 13.5                                     |
|                           | > 17 to 18 GHz       | 34.5                          | —  | 14.4                                     |
|                           | > 18 to 22 GHz       | 34.5                          | —  | 14.3                                     |
|                           | > 22 to 25 GHz       | 42.5                          | —  | 20.8                                     |
|                           | > 25 to 26.5 GHz     | 47.5                          | —  | 24.9                                     |
| Model                     | Frequency            | Internal preamplifier ON (dB) | Internal preamplifier ON + U7227/8C (dB) | Internal preamplifier ON + U7227/8F (dB) |
| N995xA, N996xA            | 10 to 100 MHz        | 18.5                          | —  | —  |
|                           | > 100 MHz to 2.1 GHz | 18.5                          | 7.6                                      | —  |
|                           | > 2.1 to 2.8 GHz     | 21.5                          | 8.5                                      | 11.1                                     |
|                           | > 2.8 to 4 GHz       | 20.5                          | 8.0                                      | 9.3                                      |
|                           | > 4 to 4.5 GHz       | 20.5                          | 7.3                                      | 9.2                                      |
|                           | > 4.5 to 6 GHz       | 22.5                          | 8.1                                      | 9.7                                      |
|                           | > 6 to 7 GHz         | 22.5                          | 7.4                                      | 9.6                                      |
|                           | > 7 to 13 GHz        | 26.5                          | 9.9                                      | 11.2                                     |
|                           | > 13 to 18 GHz       | 29.5                          | 11.0                                     | 12.1                                     |
|                           | > 18 to 22 GHz       | 29.5                          | 10.2                                     | 11.5                                     |
|                           | > 22 to 26.5 GHz     | 31.5                          | 10.9                                     | 12.1                                     |
|                           | > 26.5 to 35 GHz     | 31.5                          | —  | 11.5                                     |
|                           | > 35 to 40 GHz       | 35.5                          | —  | 12.7                                     |
|                           | > 40 to 44 GHz       | 41.5                          | —  | 16.6                                     |
| > 44 to 46 GHz            | 41.5                 | —                             | 16.1                                     |  |
|                           | > 46 to 50 GHz       | 44.5                          | —  | 18.1                                     |

<sup>1</sup> Noise figure (NF) = DANL - (-173.98 - 2.51) dB.

Nominal calculation is based on spectrum analyzer (SA) displayed average noise level (DANL) specification (dBm) stated as input terminated, RMS detection, log averaging, 0 dB input attenuation, reference level of -20 dBm, normalized to 1 Hz RBW.

Noise figure (NF) = D - (K - L), where D is the DANL (displayed average noise level) specification, K is kTB (-173.98 dBm in a 1 Hz bandwidth at 290 K), and L is 2.51 dB (the effect of log averaging used in DANL verifications).

## NF (continued)

| External preamplifier   |   |   |   |
|---|---|---|---|
| Specification   | U7227/8A  | U7227/8C  | U7227/8F  |
| Frequency   | 10 MHz to 4 GHz   | 100 MHz to 26.5 GHz   | 2 GHz to 50 GHz   |
| Noise figure (dB)   | 10 MHz to 100 MHz: < 5.5<br>100 MHz to 4 GHz: < 5                 | 100 MHz to 4 GHz: < 6<br>4 to 6 GHz: < 5<br>6 to 18 GHz: < 4<br>18 to 26.5 GHz: < 5   | 2 to 4 GHz: < 10<br>4 to 40 GHz: < 8<br>40 to 44 GHz: < 9<br>44 to 50 GHz: < 10 |
| Gain (dB)   | 10 to 100 MHz: > 16<br>100 MHz to 4 GHz: > 0.5F <sup>1</sup> + 17 | 100 MHz to 26.5 GHz: > 16.1 + 0.26F   | 2 GHz to 50 GHz: > 16.5 + 0.23F   |
| RF connector  | 3.5 mm (m)  | 3.5 mm (m)  | 2.4 mm (m)  |
| Noise source  |   |   |   |
| Model   | Frequency range   | ENR   |   |
| <b>Keysight 346 noise source family</b>                         |   |   |   |
| 346A  | 10 MHz to 18 GHz  | 5 to 7 dB   |   |
| 346B  | 10 MHz to 18 GHz  | 14 to 16 dB   |   |
| 346C  | 10 MHz to 26.5 GHz  | 12 to 17 dB   |   |
| 346CK40   | 1 GHz to 40 GHz   | 3 to 14 dB  |   |
| 346CK01   | 1 GHz to 50 GHz   | 7 to 20 dB  |   |
| <b>Keysight USB smart noise source (SNS) family<sup>2</sup></b> |   |   |   |
| U1832A  | 10 MHz to 18 GHz  | 4.5 to 6.5 dB   |   |
| U1832B  | 10 MHz to 26.5 GHz  | 4 to 7 dB   |   |
| U1833A  | 10 MHz to 18 GHz  | 14 to 16 dB   |   |
| U1833B  | 10 MHz to 26.5 GHz  | 12 to 17 dB   |   |
| U1832C  | 500 MHz to 50 GHz   | 3.5 to 8.5 dB   |   |
| U1833C  | 500 MHz to 50 GHz   | 10 to 21 dB   |   |
| U1833D  | 500 MHz to 60 GHz   | 6 to 21 dB  |   |
| Noise source setup  |   | Supplemental info   |   |
| ENR Mode  | Spot  | Single ENR value (not frequency dependent) (default: 15 dB)   |   |
|   | Table   | Applies table of ENR values vs. frequency<br>Create, save, recall, edit ENR tables<br>File type:.ENR  |   |
|   | Smart <sup>2</sup> (Auto)   | For U183x USB SNS only. When connected with a USB SNS, FieldFox updates the T cold value at beginning of every sweep, and automatically loads the ENR file from the USB SNS |   |
| T cold  | Auto (default) or Manual  | Noise temperature of cold noise standard connected to DUT during the measurement  |   |
| Connector type  | SMB (m)   | DC bias requires accessory N9910X-713 BNC to SMB cable, for 346 noise sources only  |   |
|   | USB 3.0 (Type C)  | For U183x USB SNS only  |   |
| Control voltage drive level                                     | 28 ± 1 V  | For 346 noise sources only, no need for U183x USB SNS   |   |
| Operating temperature   | 0 to 55°C   |   |   |

<sup>1</sup> F signifies frequency in GHz

<sup>2</sup> Requires FieldFox firmware rev. A.12.53 or later

## NF (continued)

| <b>Sweep</b>   |  |
|--|--|
| Number of points   | 11 (default), 21, 51, 101, 201, 401, 601, 801, 1001  |
| Sweep mode   | Continuous or single   |
| <b>DUT profiles available (built-in GUI wizard aids DUT measurement setup)</b> |  |
| Amplifier  | Includes any non-frequency-converting device   |
| Downconverter  | Frequency context can be set to RF or IF; sideband can be set to LSB, USB, DSB             |
| Upconverter  | Frequency context can be set to RF or IF; sideband can be set to LSB, USB, DSB             |
| Multi-stage converter  | Frequency context can be set to RF or IF   |
| <b>Display formats</b>   |  |
| Number of traces   | Two traces available   |
|  | Single-trace   |
| Display formats  | Dual-trace overlay (both traces on one graticule)  |
|  | Dual-trace split (each trace on separate top and bottom graticules)                        |
| Display data   | Display data, memory, data and memory  |
| Trace memory   | One memory trace per data trace, total of 2 memory traces                                  |
| Limit lines  | Upper and lower for each trace   |
| <b>Markers</b>   |  |
| Number of markers  | 6  |
| Type   | Normal, Delta, Marker Table  |
| Marker table   | Display 6 markers  |
| Marker to →  | Peak, Next Peak, Peak Left, Peak Right, Center Frequency, Reference Level, Minimum, Target |
| <b>Data storage</b>  |  |
| Data types   | Trace, Trace+State, Picture (PNG), CSV   |

The performance listed in these sections below applies to the spectrum analyzer IF output, preamplifier, interference analyzer and spectrogram, channel scanner and 89600 VSA software capabilities available in the following models:

|  |  |
|--|--|
| FieldFox RF & microwave (combination) analyzers: | N9913A, N9914A, N9915A, N9916A, N9917A, N9918A<br>N9950A, N9951A, N9952A |
| FieldFox microwave spectrum analyzers:           | N9935A, N9936A, N9937A, N9938A<br>N9960A, N9961A, N9962A                 |

See [FieldFox Configuration Guide](#) for option information. Many capabilities listed in this Data Sheet require options.

## Spectrum Analyzer IF Output

|  | Description  |
|--|--|
| Center Frequency   | 33.75 MHz  |
| IF bandwidth   | 5 MHz (default), 25 MHz  |
| Connector  | SMB male   |
| Conversion loss (RF input to SA output with -10 dBm input power, 0 dB attenuation, and preamp off) |  |
| N991xA, N993xA   | 0 to 27 dB nominal<br>The loss increases approximately linearly as frequency increases, with ~27 dB loss at 26.5 GHz |
| N995xA, N996xA   | 0 to 27 dB nominal<br>The loss increases approximately linearly as frequency increases, with ~27 dB loss at 50 GHz   |

## Preamplifier (Option 235)

|                 | Nominal  |   |
|-----------------|--|---|
| Frequency range | Full band (100 kHz to maximum frequency of instrument) |   |
| Gain            | N991xA, N993xA   | +20 dB, 100 kHz to 26.5 GHz                           |
|                 | N995xA, N996xA   | +20 dB, 100 kHz to 7.5 GHz<br>+15 dB, > 7.5 to 50 GHz |

## Interference Analyzer and Spectrogram (Option 236)

|                              | Description  |
|------------------------------|--|
| Spectrogram display          | Overlay, full screen, top, or bottom with active trace   |
| Waterfall angle              | Moderate, steep, gradual, wide angle   |
| Markers                      | Time, delta time   |
| Trace playback and recording | <ul style="list-style-type: none"> <li>Record all spectrum analyzer measurements</li> <li>Playback recorded data using FieldFox</li> <li>Frequency mask trigger allows recording to occur upon trigger</li> <li>Store data internally or USB or SD card</li> </ul> |

## Channel Scanner (Option 312)

|                              | Description  |
|------------------------------|--|
| Scan Mode                    | Range or custom list   |
| Display Type                 | Bar chart vertical, bar chart horizontal, channel power, strip chart, chart overlay, scan and listen   |
| Data logging mode            | Time with geo tagging  |
| Trace playback and recording | <ul style="list-style-type: none"> <li>Record channel power measurement</li> <li>Playback recorded data using FieldFox</li> <li>Store data internally or USB or SD card in .csv or .kml format</li> <li>Data in .kml format can be exported to Google Earth</li> </ul> |

## 89600 VSA Software

| Model                                   |  | N9913 /14 /15 /16 /17 /18A<br>N9935 /36 /37 /38A Typical <sup>1</sup> | N9950 /51 /52A<br>N9960 /61 /62A Typical <sup>1</sup> |
|---|--|---|---|
| Maximum analysis bandwidth <sup>2</sup> |  | 10 MHz  | 10 MHz  |
| IF flatness                             | Magnitude  | ± 0.2 dB  | ± 0.2 dB ≤ 26.5 GHz,<br>± 0.3 dB > 26.5 GHz           |
|   | Phase deviation from linearity <sup>3</sup>      | 2.3° peak-to-peak, 1.6° rms   | 2.6° peak-to-peak, 1.8° rms                           |
|   | Group delay flatness (peak-to-peak) <sup>3</sup> |   | 11 ns   |
| EVM (at center frequency 1 GHz)         | LTE-A FDD TM3.1 (10 MHz)                         | 0.8%  | 0.7%  |
|   | WCDMA TM4 (5 MHz)                                | 0.8%  | 0.85%   |
| EVM (at center frequency 2.1 GHz)       | LTE-A FDD TM3.1 (10 MHz)                         | 1%  | 1%  |
|   | WCDMA TM4 (5 MHz)                                | 1.1%  | 1.2%  |

<sup>1</sup> These numbers were generated from the room temperature results (23° C).

<sup>2</sup> Analysis bandwidth is the instantaneous bandwidth available around a center frequency over which the input signal can be digitized for further analysis or processing in the time, frequency, or modulation domain.

<sup>3</sup> Not guaranteed below 50 MHz.

## Over-the-Air (OTA) LTE FDD/TDD (Option 370/371)

The performance listed in this section applies to the OTA analyzer capabilities available in the following models:

|  |  |
|--|--|
| FieldFox RF & microwave (combination) analyzers: | N9913A, N9914A, N9915A, N9916A, N9917A, N9918A<br>N9950A, N9951A, N9952A |
| FieldFox microwave spectrum analyzers:           | N9935A, N9936A, N9937A, N9938A<br>N9960A, N9961A, N9962A                 |

See [FieldFox Configuration Guide](#) for option information. Many capabilities listed in this Data Sheet require options.

|              | Models         | OTA analysis frequency range <sup>1</sup> |
|--------------|----------------|---|
| N991x, N993x | N9913A         | 1 MHz to 4 GHz                            |
|              | N9914A         | 1 MHz to 6.5 GHz                          |
|              | N9915A, N9935A | 1 MHz to 9 GHz                            |
|              | N9916A, N9936A | 1 MHz to 14 GHz                           |
|              | N9917A, N9937A | 1 MHz to 18 GHz                           |
|              | N9918A, N9938A | 1 MHz to 26.5 GHz                         |
| N995x, N996x | N9950A, N9960A | 1 MHz to 32 GHz                           |
|              | N9951A, N9961A | 1 MHz to 44 GHz                           |
|              | N9952A, N9962A | 1 MHz to 50 GHz                           |

### Measurements<sup>2</sup>

#### LTE FDD/TDD Over-the-Air (OTA)

|                   |  |
|-------------------|--|
| Cell scan results | Center frequency<br>PCI (Physical Cell Identifier) (C/S/G)<br>RSRP (Reference Signal Received Power) (dBm)<br>RSRQ (Reference Signal Received Quality) (dB)<br>RSSI (Reference Signal Strength Indicator) (dBm)<br>PSS (Primary Synchronization Signal) (dBm)<br>SSS (Secondary Synchronization Signal) (dBm)<br>SINR (Signal to Interference & Noise Ratio) (dB)<br>Freq Err (Frequency Error) (Hz) |
| Data formats      | User can setup and display 1, 2, 3 or 4 simultaneous measurements of key performance indicators (KPI's) for any component carrier (CC0 through CC4), up to 5 carriers, in any combination of the following:  |
| Table             | Cell scan numeric results (for up to 6 cell sites (ID's) including Cell ID (C/S/G), RSRP, RSRQ, RSSI, PSS, SSS, SINR, Freq Err   |
| Bar chart         | Vertical power bar graph of selectable cell scan results for up to 6 cell sites with adjustable color "heat" amplitude scale   |
| Spectrum          | Magnitude spectrum frequency domain (fixed span)   |
| Strip chart       | Magnitude of selectable cell scan results graphed over time  |
| Signal bandwidth  | Up to 10 MHz   |

<sup>1</sup> Performance specified above 1 MHz. Usable down to 5 kHz.

<sup>2</sup> For center frequency signals above 1 GHz, the built-in GPS receiver (Option 307) is highly recommended or locking to any 10 MHz frequency reference. When locked to GPS as the frequency reference, this provides accuracy of  $\pm 0.01$  ppm (spec).



## OTA LTE FDD/TDD (continued)

| Setup parameters     |   |
|----------------------|---|
| Component carrier    | CC0 to CC4  |
| Channel table        | Sets frequency based on band and channel  |
| Favorites list       | Save up to 6 favorite cellular bands/channels   |
| Window configuration | Any combination of 1, 2, 3, or all 4 windows can be displayed simultaneously; 1, 2 (top & bottom), 3 (one top, two bottom), or 4 (quad display) |
| Trigger              |   |
| Trigger type         | Free run, external  |
| Trigger slope        | Positive edge, negative edge  |
| Trigger delay        | Range: -150 ms to 500 ms  |
| Auto trigger         | Forces a periodic acquisition in the absence of a trigger event<br>Range: 0 (off) to 30 s   |
| Record / Playback    |   |
| Data logging         | Record, recall and playback data for all component carrier(s)   |
| Record settings      | Meas Interval, Interval type (time or distance), time interval, distance interval   |
| Supported file types | CSV, KML  |
| Saving data          | Save/recall recorded data logs to/from internal memory or external USB stick or SD card   |

## Over-the-Air (OTA) 5GTF (Option 377)

The performance listed in this section applies to the OTA analyzer capabilities available in the following models:

|  |  |
|--|--|
| FieldFox RF & microwave (combination) analyzers: | N9913A, N9914A, N9915A, N9916A, N9917A, N9918A<br>N9950A, N9951A, N9952A |
| FieldFox microwave spectrum analyzers:           | N9935A, N9936A, N9937A, N9938A<br>N9960A, N9961A, N9962A                 |

See [FieldFox Configuration Guide](#) for option information. Many capabilities listed in this Data Sheet require options.

|              | Models         | OTA analysis frequency range <sup>1</sup> |
|--------------|----------------|---|
| N991x, N993x | N9913A         | 1 MHz to 4 GHz                            |
|              | N9914A         | 1 MHz to 6.5 GHz                          |
|              | N9915A, N9935A | 1 MHz to 9 GHz                            |
|              | N9916A, N9936A | 1 MHz to 14 GHz                           |
|              | N9917A, N9937A | 1 MHz to 18 GHz                           |
|              | N9918A, N9938A | 1 MHz to 26.5 GHz                         |
| N995x, N996x | N9950A, N9960A | 1 MHz to 32 GHz                           |
|              | N9951A, N9961A | 1 MHz to 44 GHz                           |
|              | N9952A, N9962A | 1 MHz to 50 GHz                           |

<sup>1</sup> Performance specified above 1 MHz. Usable down to 5 kHz.

## OTA 5GTF (continued)

| <b>Measurements<sup>1</sup></b> |   |
|---------------------------------|---|
| 5GTF Over-the-Air (OTA)         |   |
| Cell scan results               | Center frequency<br>PCI (Physical Cell Identifier)<br>Power (Channel Power) (dBm)<br>PSS (Primary Synchronization Signal) (dBm)<br>SSS (Secondary Synchronization Signal) (dBm)<br>Sync Corr (Sync Correlation) (%) |
| Data formats                    | User can setup and display 1, 2, 3 or 4 simultaneous measurements of key performance indicators (KPI's) for any component carrier (CC0 through CC7), up to 8 carriers, in any combination of the following:         |
| Table                           | Cell scan numeric results (for up to 6 cell sites (ID's) including Cell ID, Channel Power, PSS, SSS, Sync Corr)   |
| Bar chart                       | Vertical power bar graph of selectable cell scan results for up to 8 cell sites with adjustable color "heat" amplitude scale  |
| Spectrum                        | Magnitude spectrum frequency domain (fixed span)  |
| Strip chart                     | Magnitude of selectable cell scan results graphed over time   |
| Signal bandwidth                | Up to 10 MHz  |
| <b>Setup parameters</b>         |   |
| Component carrier               | CC0 to CC7  |
| Channel table                   | Sets frequency based on band and channel  |
| Window configuration            | Any combination of 1, 2, 3, or all 4 windows can be displayed simultaneously; 1, 2 (top & bottom), 3 (one top, two bottom), or 4 (quad display)   |
| <b>Trigger</b>                  |   |
| Trigger type                    | Free run, external  |
| Trigger slope                   | Positive edge, negative edge  |
| Trigger delay                   | Range: -150 ms to 500 ms  |
| Auto trigger                    | Forces a periodic acquisition in the absence of a trigger event<br>Range: 0 (off) to 30 s   |
| <b>Record / Playback</b>        |   |
| Data logging                    | Record, recall and playback data for all component carrier(s)   |
| Record settings                 | Meas Interval, Interval type (time or distance), time interval, distance interval   |
| Supported file types            | CSV, KML  |
| Saving data                     | Save/recall recorded data logs to/from internal memory or external USB stick or SD card   |

<sup>1</sup> For center frequency signals above 1 GHz, the built-in GPS receiver (Option 307) is highly recommended or locking to any 10 MHz frequency reference. When locked to GPS as the frequency reference, this provides accuracy of  $\pm 0.01$  ppm (spec).

## Indoor and Outdoor Mapping (Option 352)

The performance listed in this section applies to the indoor and outdoor mapping capabilities available in the following models:

|  |  |
|--|--|
| FieldFox RF & microwave (combination) analyzers: | N9913B, N9914B, N9915B, N9916B, N9917B, N9918B |
| FieldFox RF & microwave spectrum analyzers:      | N9933B, N9934B, N9935B, N9936B, N9937B, N9938B |

See [FieldFox Configuration Guide](#) for option information. Many capabilities listed in this Data Sheet require options.

Option 352 adds indoor and outdoor mapping capability to FieldFox analyzers, so that FieldFox can import maps from OpenStreetMap (OSM) for data collection and data plotting to the map directly on the FieldFox instrument display. The FieldFox indoor and outdoor mapping feature resides at the System level and the mapping capability can be enabled within the following modes:

- Channel Scanner (Option 312)
- Phased Array Antenna Support (Option 360)
- Over-the-Air (OTA) LTE FDD (Option 370)
- Over-the-Air (OTA) 5GTF (Option 377)

Indoor and outdoor mapping (Option 352) requirements:

- Spectrum analyzer mode (Option 233 on N991xB, default mode on N993xB)
- GPS receiver (Option 307), required for outdoor mapping

OSM maps can be saved to the FieldFox internal memory, SD card or USB drive. This can be done via a direct wired LAN connection or OSM maps can be downloaded and saved to FieldFox using the [FieldFox Map Support Tool](#).

|                      | Description                 |
|----------------------|-----------------------------|
| Map coordinates      | Latitude, longitude         |
| Map zoom levels      | 4 to 17                     |
| Map icons            | Flag, point, line           |
| Map labels           | On, Off                     |
| Map panorama         | North, South, East, West    |
| Data logging         | Record, recall and playback |
| Indoor map file type | PNG                         |

Using a direct wired LAN connection, FieldFox will automatically access OSM once location coordinates (latitude and longitude) and zoom levels are entered the Map Explorer menu. If using the FieldFox Map Support Tool, OSM map files can be downloaded to a .zip file and imported to FieldFox internal memory. If the FieldFox GPS receiver is enabled and OSM maps have been previously saved to FieldFox with those GPS coordinates, FieldFox can automatically load the corresponding map to match the GPS coordinates.

## EMF Measurements (Option 358)

|                          | Description   |
|--------------------------|---|
| Supported antenna        | AGOS Advanced Technologies, Triaxial Isotropic Antenna<br>Model: SDIA-6000<br>Frequency coverage: 30 MHz to 6 GHz   |
| Supported operating mode | Spectrum analyzer (Channel Power measurement only)  |
| Antenna axis             | Average all (Isotropic), X-axis, Y-axis, Z-axis   |
| Units                    | Spectrum analyzer mode: dBuV/m, dBm/m <sup>2</sup> , V/m, Watt/cm <sup>2</sup> , W/m <sup>2</sup> , dBμA/m, DBG, dBpT<br>Over-the-Air (OTA) 5G NR mode: V/m, dBμV/m |
| Measurement time         | Sweep time acquisition control can be set from 1 to 5000  |
| Data logging             | Record, recall and playback data  |
| Supported file types     | Spectrum analyzer mode: CSV<br>Over-the-Air (OTA) 5G NR mode: CSV, KML  |
| Saving data              | Save/recall recorded data logs to/from internal memory or external USB or SD card   |

## AM/FM Analog demodulation, Tune and Listen (Option 355)

The performance listed in this section applies to the AM/FM analog demodulation, tune and listen capabilities available in the following models:

|  |  |
|--|--|
| FieldFox RF & microwave (combination) analyzers: | N9913A, N9914A, N9915A, N9916A, N9917A, N9918A<br>N9950A, N9951A, N9952A |
| FieldFox microwave spectrum analyzers:           | N9935A, N9936A, N9937A, N9938A<br>N9960A, N9961A, N9962A                 |

See [FieldFox Configuration Guide](#) for option information. Many capabilities listed in this Data Sheet require options.

|                              | Description  |
|------------------------------|--|
| Display type                 | RF spectrum view, demodulated waveform, including peak+ and peak- traces                     |
| Audio demodulation type      | AM, FM narrow, FM wide, listen to the tones using FieldFox's built-in speaker or headphones  |
| Audio bandwidth              | 16 kHz   |
| Measurement type             | RF carrier power (dBm), RF carrier frequency (Hz), modulation rate (Hz), SINAD (dB), THD (%) |
| <b>Receiver IF bandwidth</b> | <b>Nominal</b>   |
| AM                           | 35 kHz   |
| FM narrow                    | 12 kHz   |
| FM wide                      | 150 kHz  |
| Listen time range            | 0 to 100 seconds   |
| <b>AM &amp; FM metrics</b>   | <b>Nominal</b>   |
| SINAD                        | 2.5 dB to 65 dB  |
| THD                          | 0 to 75%   |
| <b>AM measurements</b>       | <b>Nominal</b>   |
| Maximum modulation rate      | 5 kHz, demod sweep time: 50 $\mu$ s to 50 ms   |
| Depth                        | (peak-to-peak/2) (%), $\pm$ peak depth (%)   |
| Depth accuracy               | $\pm$ 2%   |
| Depth range                  | Modulation: 0.1 % to 99%   |
| <b>FM measurements</b>       | <b>Nominal</b>   |
| Maximum modulation rate      | 5 kHz, demod sweep time: 50 $\mu$ s to 50 ms   |
| Frequency deviation          | (Hz), $\pm$ peak deviation (Hz)  |
| Maximum deviation            | 5 MHz  |

## Radio standards

With a radio standard applied, pre-defined frequency bands, channel numbers or uplink / downlink selections can be used instead of manual frequency entry. The pre-defined FieldFox radio standards include bands such as W-CDMA, LTE, and GSM. Alternately, users can create custom standards and import them into FieldFox analyzers.

## Spectrum Analyzer Time Gating (Option 238)

The performance listed in this section applies to the spectrum analyzer time gating capabilities available in the following models:

|  |  |
|--|--|
| FieldFox RF & microwave (combination) analyzers: | N9913A, N9914A, N9915A, N9916A, N9917A, N9918A<br>N9950A, N9951A, N9952A |
| FieldFox microwave spectrum analyzers:           | N9935A, N9936A, N9937A, N9938A<br>N9960A, N9961A, N9962A                 |

See [FieldFox Configuration Guide](#) for option information. Many capabilities listed in this Data Sheet require options.

With time gating, you can measure the spectrum of a periodic signal during a specified time interval. Pulsed-RF signals are an example of a periodic signal that can be measured with time gating. For example, you can measure the pulse during the on period, not the transition or the off period. Or you can exclude interfering signals such as a periodic transient. Time gating allows you to view spectral components that would otherwise be hidden. FieldFox's time gating method is a Gated FFT.

|                           | Description                               |
|---------------------------|---|
| Gate method               | Gated FFT                                 |
| Span range                | Any span                                  |
| RBW range                 | 1 Hz to 300 kHz (derived from gate width) |
| Gate delay range          | -150 ms to 10 s                           |
| Gate width (length) range | 6 $\mu$ s to 1.8 s                        |
| Gate sources              | External, RF burst, Video                 |

## Reflection Measurements (RL, VSWR) (Option 320, applicable to SA only models)

The performance listed in this section applies to the reflection measurements capabilities available in the following models:

|  |   |
|--|---|
| FieldFox microwave spectrum analyzers: | N9935A, N9936A, N9937A, N9938A <sup>1</sup><br>N9960A, N9961A, N9962A |
|--|---|

See [FieldFox Configuration Guide](#) for option information. Many capabilities listed in this Data Sheet require options.

|        | Models              | Reflection Measurements |
|--------|---------------------|-------------------------|
| N993xA | N9935A              | 30 kHz to 9 GHz         |
|        | N9936A              | 30 kHz to 14 GHz        |
|        | N9937A              | 30 kHz to 18 GHz        |
|        | N9938A <sup>1</sup> | 30 kHz to 26.5 GHz      |
| N996xA | N9960A              | 300 kHz to 32 GHz       |
|        | N9961A              | 300 kHz to 44 GHz       |
|        | N9962A              | 300 kHz to 50 GHz       |

### Measurements

Return loss, VSWR normalization using data/memory

<sup>1</sup> Reflection measurements in N9938A specifically require 3.5 mm (m) test ports instead of the standard Type-N (f).

## Extended Range Transmission Analysis (ERTA) (Option 209)

ERTA specifications apply to the following FieldFox models. The RF & microwave analyzers must be equipped with the spectrum analyzer option.

|  |  |
|--|--|
| FieldFox RF & microwave (combination) analyzers: | N9913A, N9914A, N9915A, N9916A, N9917A, N9918A<br>N9950A, N9951A, N9952A |
| FieldFox microwave spectrum analyzers:           | N9935A, N9936A, N9937A, N9938A<br>N9960A, N9961A, N9962A                 |

ERTA operation requires two FieldFox units, each one configured with specific options, and certain accessories. See [FieldFox Configuration Guide](#) for option information. Many capabilities listed in this Data Sheet require options.

### System description

ERTA can be used to measure the scalar transmission gain or loss of an RF system. It is useful when measuring long lossy cables where the two ends cannot easily be brought together, such as those bolted in on ships or aircrafts. It is also useful in measuring the insertion loss of waveguide systems, or using the frequency-offset feature, devices such as mixers and converters.

ERTA measurements are based on two FieldFox units; one at each end of the measured DUT. One FieldFox is the source and reference receiver (R), while the other is the measurement receiver (B). The two FieldFox units are synchronized using hardware triggering. By taking advantage of FieldFox's InstAlign technique, ERTA can be used to make accurate gain or loss measurements.

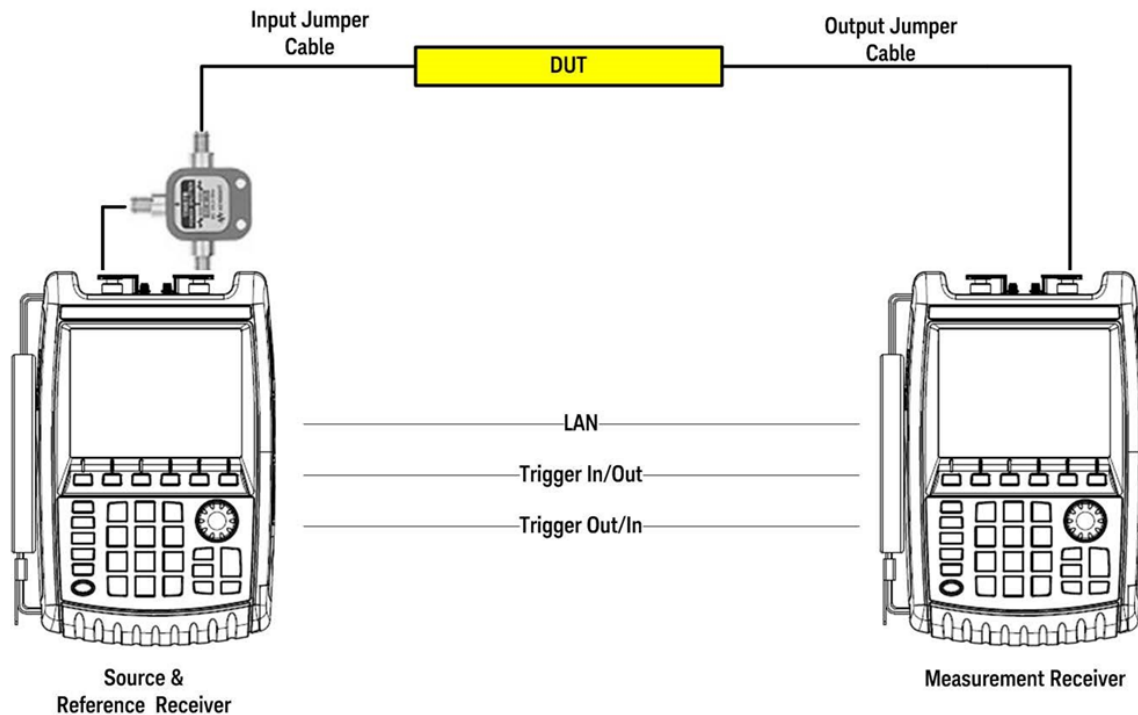

## ERTA (continued)

### Frequency specifications

The ERTA frequency range is limited by each individual analyzer's frequency range.

|                | <b>Models</b>  | <b>Reflection measurements</b> | <b>Receiver frequency range<sup>1</sup></b> |
|----------------|----------------|--------------------------------|---|
| N991xA, N993xA | N9913A         | 30 kHz to 4 GHz                | 100 kHz to 4 GHz                            |
|                | N9914A         | 30 kHz to 6.5 GHz              | 100 kHz to 6.5 GHz                          |
|                | N9915A, N9935A | 30 kHz to 9 GHz                | 100 kHz to 9 GHz                            |
|                | N9916A, N9936A | 30 kHz to 14 GHz               | 100 kHz to 14 GHz                           |
|                | N9917A, N9937A | 30 kHz to 18 GHz               | 100 kHz to 18 GHz                           |
|                | N9918A, N9938A | 30 kHz to 26.5 GHz             | 100 kHz to 26.5 GHz                         |
| N995xA, N996xA | N9950A, N9960A | 300 kHz to 32 GHz              | 300 kHz to 32 GHz                           |
|                | N9951A, N9961A | 300 kHz to 44 GHz              | 300 kHz to 44 GHz                           |
|                | N9952A, N9962A | 300 kHz to 50 GHz              | 300 kHz to 50 GHz                           |

#### Frequency reference

Refer to the frequency accuracy specifications.

#### Source output power

Refer to the test port output power typical data.

#### Frequency setup parameters

|                           |   |
|---------------------------|---|
| Receiver frequency        | Center/span or start/stop (standard spectrum analyzer settings)<br>Reverse receiver sweep direction (default direction is forward, but can be set to reverse)   |
| Source frequency [Remote] | [Tracking] – FieldFox source tracks the receiver by default. The frequencies are identical.<br>[CW] – FieldFox's source can be set to a CW frequency independent of FieldFox's receiver frequency. FieldFox's source is at a single CW frequency; FieldFox's receiver is swept.<br>[Coupled CW] – FieldFox's source CW frequency is auto-coupled to FieldFox's receiver [Center Frequency] setting. |

#### Frequency-offset capability

This feature allows the FieldFox's source frequency to be offset from FieldFox's receiver frequency. The offset frequency can be negative, zero, or positive. The frequency-offset capability is useful when characterizing the scalar transmission response of devices such as mixers and converters.

<sup>1</sup> The receiver (spectrum analyzer) is usable to 5 kHz, though only specified to 100 kHz or 300 kHz.



## ERTA (continued)

### Frequency specifications (continued)

| Frequency-offset setup parameters |   |
|-----------------------------------|---|
| Receiver frequency                | Center/span or start/stop (standard spectrum analyzer settings)<br>Reverse receiver sweep direction (default direction is forward, but can be set to reverse)   |
| Frequency tracking offset         | On/Off<br>Offset values: 0, > 0, < 0  |
| Receiver sweep direction          | Reversal: Off<br>Default setting<br>Both source and receiver sweep in the forward direction. Receiver stop frequency > Receiver start frequency<br>Source frequency = Offset + Receiver frequency<br><br>Reversal: On<br>Source and receiver sweep in opposite directions.<br>Source frequency = Offset – Receiver frequency<br>Offset > receiver frequency |

### Dynamic range and maximum attenuation

**Dynamic range** is the difference between the maximum output power available from FieldFox's source and the noise floor of the second FieldFox, while ensuring that neither FieldFox's ADC goes into over-range. Dynamic range also accounts for the loss of the power splitter. Dynamic range is applicable when testing devices such as filters, where there is low loss in the passband, and significant loss in the stopband, and both passband and stopband need to be on the display at the same time (same sweep).

**Maximum attenuation** is the difference between maximum output power available from FieldFox's source and the noise floor of FieldFox. It also accounts for the loss of power splitter. Maximum attenuation is applicable when testing devices such as cables, which have relatively uniform loss over the swept frequency range.

The values shown are based on the recommended minimum RBW of 3 kHz when the frequency references are locked via GPS, and 300 kHz when the frequency references are unlocked. Locking the frequency references to GPS allows for greater frequency accuracy of the FieldFox units and use of a narrower RBW, which in turn results in a lower DANL, and hence a wider measurement range. When the GPS signals cannot be present at all times, the GPS hold-over mode can be used.

## ERTA (continued)

### Dynamic range and maximum attenuation (continued)

| Dynamic range (dB)            |   | Typical                                       |  |  |  |
|-------------------------------|---|---|--|--|--|
| N991xA, N993xA                | Preamp off                                    | Preamp on                                     | Preamp off                                 | Preamp on                                  |  |
|                               | Frequency references locked to GPS, RBW 3 kHz | Frequency references locked to GPS, RBW 3 kHz | Frequency references unlocked, RBW 300 kHz | Frequency references unlocked, RBW 300 kHz |  |
| > 2 MHz <sup>1</sup> to 6 GHz | 88  | 83  | 68   | 63   |  |
| > 6 to 13 GHz                 | 86  | 83  | 66   | 63   |  |
| > 13 to 22 GHz                | 70  | 86  | 50   | 66   |  |
| > 22 to 25 GHz                | 63  | 83  | 43   | 63   |  |
| > 25 to 26.5 GHz              | 58  | 77  | 38   | 57   |  |

| Maximum attenuation (dB) |   | Typical                                       |  |  |  |
|--------------------------|---|---|--|--|--|
| N991xA, N993xA           | Preamp off                                    | Preamp on                                     | Preamp off                                 | Preamp on                                  |  |
|                          | Frequency references locked to GPS, RBW 3 kHz | Frequency references locked to GPS, RBW 3 kHz | Frequency references unlocked, RBW 300 kHz | Frequency references unlocked, RBW 300 kHz |  |
| > 2 MHz to 6 GHz         | 93  | 108   | 73   | 88   |  |
| > 6 to 13 GHz            | 86  | 103   | 66   | 83   |  |
| > 13 to 22 GHz           | 70  | 91  | 50   | 71   |  |
| > 22 to 25 GHz           | 63  | 83  | 43   | 63   |  |
| > 25 to 26.5 GHz         | 58  | 77  | 38   | 57   |  |

| Dynamic range (dB) |   | Typical                                       |  |  |  |
|--------------------|---|---|--|--|--|
| N995xA, N996xA     | Preamp off                                    | Preamp on                                     | Preamp off                                 | Preamp on                                  |  |
|                    | Frequency references locked to GPS, RBW 3 kHz | Frequency references locked to GPS, RBW 3 kHz | Frequency references unlocked, RBW 300 kHz | Frequency references unlocked, RBW 300 kHz |  |
| > 2 to 5 MHz       | 83  | 87  | 62   | 58   |  |
| > 5 MHz to 11 GHz  | 93  | 97  | 69   | 68   |  |
| > 11 to 19 GHz     | 95  | 96  | 71   | 70   |  |
| > 19 to 22 GHz     | 93  | 94  | 69   | 68   |  |
| > 22 to 40 GHz     | 88  | 90  | 63   | 65   |  |
| > 40 to 43 GHz     | 82  | 89  | 57   | 64   |  |
| > 43 to 46 GHz     | 81  | 93  | 56   | 68   |  |
| > 46 to 50 GHz     | 77  | 88  | 52   | 63   |  |

| Maximum attenuation (dB) |   | Typical                                       |  |  |  |
|--------------------------|---|---|--|--|--|
| N995xA, N996xA           | Preamp off                                    | Preamp on                                     | Preamp off                                 | Preamp on                                  |  |
|                          | Frequency references locked to GPS, RBW 3 kHz | Frequency references locked to GPS, RBW 3 kHz | Frequency references unlocked, RBW 300 kHz | Frequency references unlocked, RBW 300 kHz |  |
| > 2 MHz to 13 GHz        | 100   | 113   | 74   | 88   |  |
| > 13 to 18 GHz           | 101   | 110   | 76   | 85   |  |
| > 18 to 22 GHz           | 99  | 108   | 74   | 83   |  |
| > 22 to 35 GHz           | 95  | 105   | 70   | 80   |  |
| > 35 to 40 GHz           | 88  | 100   | 63   | 75   |  |
| > 40 to 46 GHz           | 81  | 93  | 56   | 63   |  |
| > 46 to 50 GHz           | 77  | 88  | 52   | 63   |  |

<sup>1</sup> Dynamic range is decreased from 3 to 9 dB at 2 MHz.

## Absolute power and gain measurement uncertainties

Verified with input level of -10 dBm, peak detector, 10 dB attenuation, preamplifier off, all settings auto-coupled, no warm-up required. Includes frequency response uncertainties. Assumes an ERTA system using a Keysight 11667A, 11667B, or 11667C power splitter.

| <b>N991xA and N993xA</b>  |                             |                                |                                |                                   |
|---|-----------------------------|--------------------------------|--------------------------------|-----------------------------------|
| <b>Input power (R) measurements uncertainty, 30 kHz RBW (dB)</b>                                      |                             |                                |                                |                                   |
|   | <b>Spec<br/>(23 ± 5 °C)</b> | <b>Spec<br/>(-10 to 55 °C)</b> | <b>Typical<br/>(23 ± 5 °C)</b> | <b>Typical<br/>(-10 to 55 °C)</b> |
| 100 kHz to 18 GHz   | ± 1.10                      | ± 1.30                         | ± 0.40                         | ± 0.50                            |
| > 18 to 26.5 GHz  | ± 1.40                      | ± 1.50                         | ± 0.50                         | ± 0.60                            |
| <b>Output power (B) measurement uncertainty, frequency references locked to GPS, RBW ≥ 3 kHz (dB)</b> |                             |                                |                                |                                   |
|   | <b>Spec<br/>(23 ± 5 °C)</b> | <b>Spec<br/>(-10 to 55 °C)</b> | <b>Typical<br/>(23 ± 5 °C)</b> | <b>Typical<br/>(-10 to 55 °C)</b> |
| 100 kHz to 18 GHz   | ± 1.00                      | ± 1.20                         | ± 0.40                         | ± 0.50                            |
| > 18 to 26.5 GHz  | ± 1.20                      | ± 1.40                         | ± 0.50                         | ± 0.60                            |
| <b>Output power (B) measurement uncertainty, frequency references unlocked, RBW ≥ 300 kHz (dB)</b>    |                             |                                |                                |                                   |
|   | <b>Spec<br/>(23 ± 5 °C)</b> | <b>Spec<br/>(-10 to 55 °C)</b> | <b>Typical<br/>(23 ± 5 °C)</b> | <b>Typical<br/>(-10 to 55 °C)</b> |
| 100 kHz to 18 GHz   | ± 1.00                      | ± 1.30                         | ± 0.40                         | ± 0.50                            |
| > 18 to 26.5 GHz  | ± 1.40                      | ± 1.60                         | ± 0.50                         | ± 0.60                            |
| <b>Gain/Loss (B/R) measurement uncertainty, frequency references locked to GPS, RBW ≥ 3 kHz (dB)</b>  |                             |                                |                                |                                   |
|   | <b>Spec<br/>(23 ± 5 °C)</b> | <b>Spec<br/>(-10 to 55 °C)</b> | <b>Typical<br/>(23 ± 5 °C)</b> | <b>Typical<br/>(-10 to 55 °C)</b> |
| 100 kHz to 18 GHz   | ± 1.30                      | ± 1.70                         | ± 0.60                         | ± 0.70                            |
| > 18 to 26.5 GHz  | ± 1.70                      | ± 2.10                         | ± 0.70                         | ± 0.90                            |
| <b>Gain/Loss (B/R) measurement uncertainty, frequency references unlocked, RBW ≥ 300 kHz (dB)</b>     |                             |                                |                                |                                   |
|   | <b>Spec<br/>(23 ± 5 °C)</b> | <b>Spec<br/>(-10 to 55 °C)</b> | <b>Typical<br/>(23 ± 5 °C)</b> | <b>Typical<br/>(-10 to 55 °C)</b> |
| 100 kHz to 18 GHz   | ± 1.40                      | ± 1.70                         | ± 0.70                         | ± 0.70                            |
| > 18 to 26.5 GHz  | ± 2.00                      | ± 2.10                         | ± 0.90                         | ± 1.00                            |
| <b>N995xA and N996xA</b>  |                             |                                |                                |                                   |
| <b>Input power (R) measurements uncertainty, 30 kHz RBW (dB)</b>                                      |                             |                                |                                |                                   |
|   | <b>Spec<br/>(23 ± 5 °C)</b> | <b>Spec<br/>(-10 to 55 °C)</b> | <b>Typical<br/>(23 ± 5 °C)</b> | <b>Typical<br/>(-10 to 55 °C)</b> |
| 2 MHz to 18 GHz   | ± 1.10                      | ± 1.30                         | ± 0.50                         | ± 0.60                            |
| > 18 to 32 GHz  | ± 1.20                      | ± 1.50                         | ± 0.50                         | ± 0.70                            |
| > 32 to 40 GHz  | ± 1.30                      | ± 1.80                         | ± 0.60                         | ± 0.80                            |
| > 40 to 43 GHz  | ± 1.60                      | ± 2.30                         | ± 0.70                         | ± 1.10                            |
| > 43 to 50 GHz  | ± 1.70                      | ± 3.20                         | ± 0.80                         | ± 1.40                            |

## Absolute power and gain measurement uncertainties (continued)

| Output power (B) measurement uncertainty, frequency references locked to GPS, RBW ≥ 3 kHz (dB) |                     |                        |                        |                           |
|--|---------------------|------------------------|------------------------|---------------------------|
|  | Spec<br>(23 ± 5 °C) | Spec<br>(-10 to 55 °C) | Typical<br>(23 ± 5 °C) | Typical<br>(-10 to 55 °C) |
| 2 MHz to 18 GHz  | ± 0.40              | ± 1.00                 | ± 0.40                 | ± 0.50                    |
| > 18 to 32 GHz   | ± 0.45              | ± 1.30                 | ± 0.40                 | ± 0.60                    |
| > 32 to 40 GHz   | ± 0.50              | ± 1.50                 | ± 0.50                 | ± 0.70                    |
| > 40 to 43 GHz   | ± 0.80              | ± 2.30                 | ± 0.70                 | ± 1.00                    |
| > 43 to 50 GHz   | ± 0.90              | ± 3.00                 | ± 0.80                 | ± 1.40                    |
| Output power (B) measurement uncertainty, frequency references unlocked, RBW ≥ 300 kHz (dB)    |                     |                        |                        |                           |
|  | Spec<br>(23 ± 5 °C) | Spec<br>(-10 to 55 °C) | Typical<br>(23 ± 5 °C) | Typical<br>(-10 to 55 °C) |
| 2 MHz to 18 GHz  | ± 1.00              | ± 1.10                 | ± 0.40                 | ± 0.50                    |
| > 18 to 32 GHz   | ± 1.20              | ± 1.50                 | ± 0.50                 | ± 0.60                    |
| > 32 to 40 GHz   | ± 1.60              | ± 1.90                 | ± 0.60                 | ± 0.80                    |
| > 40 to 43 GHz   | ± 2.10              | ± 2.50                 | ± 0.70                 | ± 1.30                    |
| > 43 to 50 GHz   | ± 2.60              | ± 3.60                 | ± 1.00                 | ± 1.60                    |
| Gain/Loss (B/R) measurement uncertainty, frequency references locked to GPS, RBW ≥ 3 (dB)      |                     |                        |                        |                           |
|  | Spec<br>(23 ± 5 °C) | Spec<br>(-10 to 55 °C) | Typical<br>(23 ± 5 °C) | Typical<br>(-10 to 55 °C) |
| 2 MHz to 18 GHz  | ± 1.40              | ± 1.70                 | ± 0.60                 | ± 0.70                    |
| > 18 to 32 GHz   | ± 1.50              | ± 2.00                 | ± 0.70                 | ± 0.90                    |
| > 32 to 40 GHz   | ± 1.60              | ± 2.30                 | ± 0.80                 | ± 1.00                    |
| > 40 to 43 GHz   | ± 2.20              | ± 3.10                 | ± 1.00                 | ± 1.40                    |
| > 43 to 50 GHz   | ± 2.40              | ± 4.00                 | ± 1.20                 | ± 1.90                    |
| Gain/Loss (B/R) measurement uncertainty, frequency references unlocked, RBW ≥ 300 kHz (dB)     |                     |                        |                        |                           |
|  | Spec<br>(23 ± 5 °C) | Spec<br>(-10 to 55 °C) | Typical<br>(23 ± 5 °C) | Typical<br>(-10 to 55 °C) |
| 2 MHz to 18 GHz  | ± 1.40              | ± 1.70                 | ± 0.70                 | ± 0.70                    |
| > 18 to 32 GHz   | ± 1.80              | ± 2.10                 | ± 0.80                 | ± 1.00                    |
| > 32 to 40 GHz   | ± 2.10              | ± 2.80                 | ± 1.00                 | ± 1.30                    |
| > 40 to 43 GHz   | ± 2.70              | ± 3.50                 | ± 1.40                 | ± 1.70                    |
| > 43 to 50 GHz   | ± 3.00              | ± 4.80                 | ± 1.60                 | ± 2.40                    |

## Cable correction

Input and output jumper cable losses can be accounted for using ERTA's cable correction wizard.

The performance listed in built-in power meter, external USB power sensor support, pulse measurements, USB power sensor measurements versus frequency, built-in GPS receiver, DC bias variable voltage source and remote control capability sections applies to the capabilities available in the following models:

|  |  |
|--|--|
| FieldFox RF & microwave (combination) analyzers: | N9913A, N9914A, N9915A, N9916A, N9917A, N9918A<br>N9950A, N9951A, N9952A |
| FieldFox microwave spectrum analyzers:           | N9935A, N9936A, N9937A, N9938A<br>N9960A, N9961A, N9962A                 |

See [FieldFox Configuration Guide](#) for option information. Many capabilities listed in this Data Sheet require options.

## Built-in Power Meter (Option 310)

Using the built-in power meter, FieldFox is able to make very accurate channel power measurements. The channel bandwidth can be set wide to simulate average power meter measurements. This measurement function provides the flexibility to make user definable channel power measurements.

| Description            |  |                     |                 |
|------------------------|--|---------------------|-----------------|
| Setup parameters       | Center frequency, including selection of radio standards and channel selection, span or channel width  |                     |                 |
| Functions              | Relative/absolute measurements, offsets, units of dBm or Watts, or dB or %, minimum and maximum limits |                     |                 |
| Models                 | Frequency range  |                     |                 |
| N991xA, N992xA, N993xA | N9913A   | 100 kHz to 4 GHz    | Usable to 5 kHz |
|                        | N9914A   | 100 kHz to 6.5 GHz  | Usable to 5 kHz |
|                        | N9915A, N9925A, N9935A   | 100 kHz to 9 GHz    | Usable to 5 kHz |
|                        | N9916A, N9926A, N9936A   | 100 kHz to 14 GHz   | Usable to 5 kHz |
|                        | N9917A, N9927A, N9937A   | 100 kHz to 18 GHz   | Usable to 5 kHz |
|                        | N9918A, N9928A, N9938A   | 100 kHz to 26.5 GHz | Usable to 5 kHz |
| N995xA, N996xA         | N9950A, N9960A   | 9 kHz to 32 GHz     | Usable to 5 kHz |
|                        | N9951A, N9961A   | 9 kHz to 44 GHz     | Usable to 5 kHz |
|                        | N9952A, N9962A   | 9 kHz to 50 GHz     | Usable to 5 kHz |

| Amplitude accuracy (dB)  |                  |                     |                     |                        |
|--|------------------|---------------------|---------------------|------------------------|
| N991xA, N992xA, N993xA   | Spec (23 ± 5 °C) | Spec (-10 to 55 °C) | Typical (23 ± 5 °C) | Typical (-10 to 55 °C) |
| 10 dB attenuation, input signal -15 to -5 dBm, peak detector, 300 Hz RBW, all settings auto-coupled, includes frequency response uncertainties. No warm-up required. |                  |                     |                     |                        |
| 100 kHz to 18 GHz  | ± 0.80           | ± 1.00              | ± 0.35              | ± 0.50                 |
| > 18 to 26.5 GHz   | ± 1.00           | ± 1.20              | ± 0.50              | ± 0.60                 |
| N995xA, N996xA   | Spec (23 ± 5 °C) | Spec (-10 to 55 °C) | Typical (23 ± 5 °C) | Typical (-10 to 55 °C) |
| 9 to 100 kHz   | ± 1.60           | ± 2.50              | ± 0.60              | ± 1.30                 |
| > 100 kHz to 2 MHz   | ± 1.30           | ± 1.90              | ± 0.60              | ± 0.80                 |
| > 2 to 15 MHz  | ± 1.00           | ± 1.20              | ± 0.30              | ± 0.50                 |
| > 15 MHz to 32 GHz   | ± 0.90           | ± 1.00 <sup>1</sup> | ± 0.30              | ± 0.50                 |
| > 32 to 40 GHz   | ± 1.10           | ± 1.60              | ± 0.50              | ± 0.70                 |
| > 40 to 43 GHz   | ± 1.50           | ± 2.20              | ± 0.50              | ± 0.70                 |
| > 43 to 50 GHz   | ± 1.60           | ± 2.90              | ± 0.50              | ± 0.90                 |

<sup>1</sup> Increase by 0.3 dB between 18 and 32 GHz.

## External USB Power Sensor Support (Option 302)

The external USB power sensor option supports various Keysight USB power sensors. For an up-to-date listing of the supported power sensors, visit <http://www.keysight.com/find/fieldfoxsupport>.

|                  | Description   |
|------------------|---|
| Setup parameters | Frequency   |
| Functions        | Relative/absolute measurements, offsets, units of dBm or Watts, or dB or %, minimum and maximum limits.                               |
| Internal source  | FieldFox's internal source can be turned on in the USB power sensor mode. CW frequency and nominal power level control are available. |

## Pulse Measurements (Option 330)

FieldFox's pulse measurement option can be used to characterize RF pulses such as those used in radar and electronic warfare systems. Measurements are made using FieldFox and Keysight's USB peak power sensors.

Performance specifications such as frequency, dynamic range and minimum pulse width depend on the peak power sensor. Supported peak power sensors: <http://www.keysight.com/find/fieldfoxsupport>

|                  | Description   |
|------------------|---|
| Setup parameters | Frequency, time (center), time/division, gating, triggering, video bandwidth, averaging |
| Functions        | Average power, peak power, and peak to average ratio                                    |
|                  | Analog gauge display and digital display, dBm and Watts                                 |
|                  | Relative/absolute measurements, offset, dB or %, minimum and maximum limits             |
|                  | Trace graph for pulse profiling with gating   |
|                  | Rise time, fall time, pulse width, pulse period, pulse repetition frequency             |

## USB Power Sensor Measurements versus Frequency (Option 208)

This feature allows FieldFox's source frequency to be set independently from the power sensor (receiver) frequency. With frequency-offset using power sensor (FOPS), the frequency of both the source and receiver are swept, and the two track each other. The offset frequency can be negative, zero, or positive.

FOPS can be used to characterize the scalar transmission response of devices such as mixers and converters. This frequency-offset capability is necessary for conversion loss/gain measurements on frequency-translating devices, since by definition, the input and output frequencies of the DUT are different. The FieldFox source stimulates the DUT and the power sensor is used as the measurement receiver.

Since power sensors are inherently broadband devices (not frequency-selective), the user should ensure that only the signal of interest is present at the power sensor input and that all other signals are filtered appropriately.

## USB Power Sensor Measurements versus Frequency (continued)

| Setup parameters   |  |
|--|--|
| Source frequency   | Center/span or start/stop              |
| Receiver frequency   | Range determined by power sensor range |
| Frequency offset   | Positive offset or negative offset     |
| Frequency step size  | 30 kHz minimum                         |
| Number of points   | 2 to 1601                              |
| Combination of number of points and frequency step size limited by span. |  |
| Dwell time/point   | 0 to 1.0 sec                           |

Source frequency span must be equal to receiver frequency span.

Receiver sweep direction: forward (default setting) or reverse.

For some DUTs, the output frequency may sweep in a reverse direction, as compared to the source frequency. The basic relationships between the source, receiver and offset frequencies are shown in the table below. The FieldFox analyzer includes an offset calculator that ensures a fast measurement setup.

| Src sweep direction           | Rx sweep direction          | Frequency calculations   |
|-------------------------------|-----------------------------|--|
| Forward $f_{2src} > f_{1src}$ | Forward $f_{2rx} > f_{1rx}$ | Receiver frequency = Source frequency $\pm$ Offset                             |
| Forward $f_{2src} > f_{1src}$ | Reverse $f_{2rx} > f_{1rx}$ | Receiver frequency =<br>Offset - Source Frequency<br>Offset > Source frequency |

|               | Description  |
|---------------|--|
| Measurements  | Source power, gain/loss and receiver (Rx) power<br>Gain = Rx power / source power (memory). Source power (memory) is measured during setup.  |
| Output power  | Refer to the test port output power typical data on page 5.  |
| Dynamic range | The dynamic range with FOPS is dependent on FieldFox's output power and the power sensor's dynamic range.<br>Supported USB power sensors: <a href="http://www.keysight.com/find/fieldfoxsupport">www.keysight.com/find/fieldfoxsupport</a> |

The graph below shows a filter measurement using two different power sensors, the U2002A (-60 to +20 dBm) and the U2021XA (-45 to +20 dBm). While a filter is not commonly measured using FOPS, it is a useful device for demonstrating dynamic range.

For both measurements, the FieldFox source power was set to -1 dBm, the maximum available in the selected frequency range of 7.25 to 13.25 GHz. An external amplifier was not used in this case, but one can be added to increase the source power and hence dynamic range.

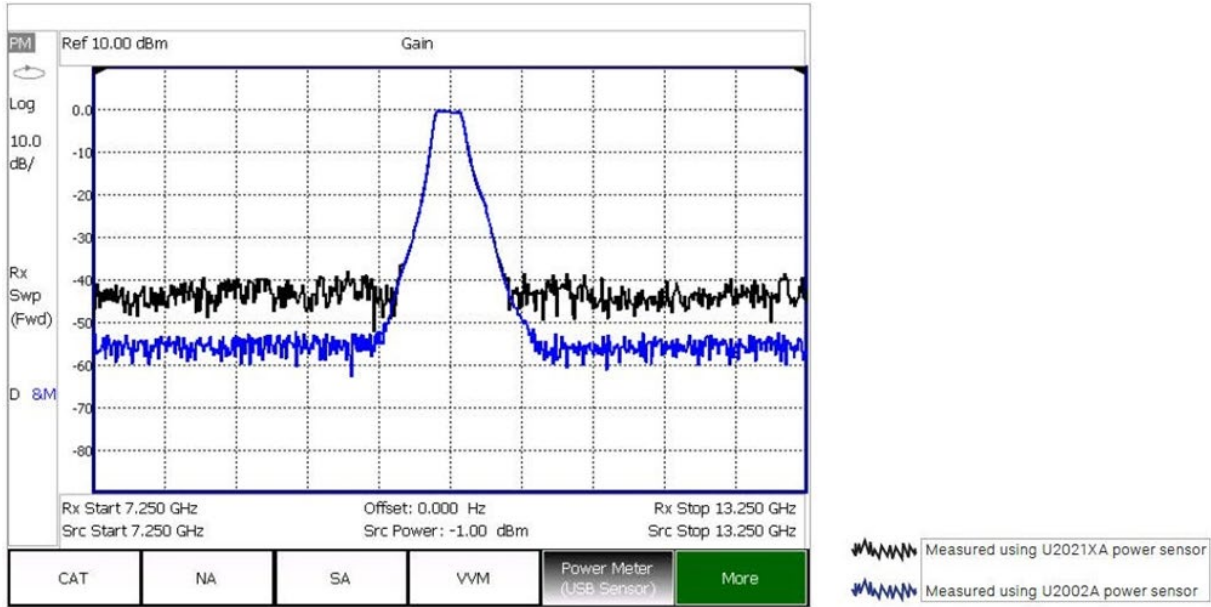

Example showing typical dynamic range of FOPS

## Built-In GPS Receiver (Option 307)

|                       | Description   |
|-----------------------|---|
| GPS receiver          | The internal GPS receiver can be used as a frequency reference. <sup>1</sup>  |
| Modes                 | Off, internal, external   |
| Sync clock            | On, off   |
| Functionality         | Geo-location: latitude, longitude, altitude (elevation), time, sync time/date<br>Requires external GPS antenna (can use N9910X-825, GPS active antenna) |
| Connector for antenna | SMA (f), 3.3 V  |
| Maximum DC current    | 13 mA   |

## DC Bias Variable-Voltage Source (Option 309)

|                               | Description  |
|-------------------------------|--|
|                               | Nominal  |
| Connector                     | SMB (m)  |
| Voltage                       | +1 to +32 V  |
| Resolution                    | 0.1 V  |
| Maximum current <sup>2</sup>  | 0.65 A   |
| DC current readout resolution | 0.01 A   |
| Maximum power <sup>2</sup>    | 7 watts  |
| Display read out              | Voltage, current   |
| Overload trip protection      | Automatically engages when voltage source is on.<br>The trip circuit can be reset from front panel without presetting or power cycling the analyzer. |

<sup>1</sup> External GPS USB receivers can be used to provide geo-location data. However, they cannot be used for frequency reference locking.

<sup>2</sup> Battery life will be reduced when DC source is used. A trip function turns off the power supply when the rated current or power is exceeded.



## Remote Control Capability (Option 030)

Option 030 adds remote control capability to FieldFox analyzers, so that FieldFox can be controlled via an iOS device, or an Android device. The FieldFox app, running on the iOS/Android device, combined with Option 030 on the FieldFox analyzer provides full control of the instrument from a remote location. The app emulates the front panel of FieldFox, so users can press the FieldFox hard keys or softkeys using their iPhone/iPad, or Android mobile device and make measurements remotely. For example, a tower climber can be on the tower with a FieldFox analyzer, while the technician controls and makes the measurements down below, using an iPad. The iPad and FieldFox communicate via a network connection.

| iOS device requirements               | Android device requirements           |
|---------------------------------------|---------------------------------------|
| iPad, iPhone, or iPod Touch           | Android phone, tablet PC              |
| iOs of 6.1 or higher                  | Android OS of 9.0 or higher           |
| A WiFi or cellular network connection | A WiFi or cellular network connection |

The FieldFox app communicates with FieldFox via a network connection, so both the iOS/Android device and FieldFox need to be on a network where both devices can reach the other. For example, a company intranet or a site installation using a wireless router. FieldFox can directly be connected to a LAN cable, or if wired LAN is not available, a user supplied wireless router can be configured to work with FieldFox. FieldFox does not include a wireless router.

## FieldFox app without Option 030

The FieldFox app can be installed on an iOS or an Android device independent of the presence of Option 030 on the analyzer. Without Option 030, users can view the live display screen of their FieldFox remotely but cannot control the instrument. With 030 purchased and installed on their FieldFox, users can both view and control their FieldFox. Control refers to the ability to press hard keys, softkeys, make or change measurements, etc. Option 030 does not include the iOS or the Android device itself. Users must supply their own iOS or Android device. Option 030 is a license on the FieldFox analyzer. Option 030 and the FieldFox app are not applicable to BlackBerry, or Windows phone/tablet devices. FieldFox can be remotely controlled via PC software using a wireless or wired LAN connection. FieldFox Data Link software provides a remote display tool with a virtual keypad that allows remote access to the FieldFox display (Option 030 not required).

## EMI measurements (Option 361)

|                  | Description  |
|------------------|--|
| Frequency Range  | Same as spectrum analyzer frequency range  |
| Number of traces | 4, each trace can be configured with individual trace mode and detector type                 |
| Trace mode       | Max hold, Min, Clear/Write, View and blank. (Average is implemented as EMI average detector) |
| Detector         | Positive Peak, Quasi-Peak, EMI average   |
| CISPR bandwidth  | 200 Hz, 9 kHz, 120 kHz, 1MHz   |
| Measurements     | Frequency scan, CISPR 16-1-1 Amplitude probability distribution (APD)                        |

## General Information

|                              |   |
|------------------------------|---|
| <b>Calibration cycle</b>     |   |
|                              | 1 year  |
| <b>Weight</b>                |   |
| N991xA, N992xA, N993xA       | 3.0 kg or 6.6 lb. including battery           |
| N995xA, N996xA               | 3.2 kg or 7.1 lb. including battery           |
| <b>Dimensions: H x W x D</b> |   |
|                              | 292 x 188 x 72 mm (11.5 in x 7.4 in x 2.8 in) |

|                             |  |
|-----------------------------|--|
| <b>Environmental</b>        |  |
| MIL-PRF-28800F Class 2      | Operating temperature<br>Storage temperature<br>Operating humidity<br>Random vibration<br>Functional shock<br>Bench drop                       |
| Maximum humidity            | Maximum relative humidity (non-condensing): 95% relative humidity up to 40°C, decreases linearly to 45% relative humidity at 55°C <sup>1</sup> |
| Altitude – operating        | 9,144 m or 30,000 ft (using battery)   |
| Altitude – Non-operating    | 15,240 m or 50,000 ft  |
| Altitude – AC to DC adapter | 3,000 m or 9,840 ft  |

|                           |   |
|---------------------------|---|
| <b>Ingress protection</b> |   |
|                           | This product has been type tested to meet the requirements for ingress protection IP53 in accordance with IEC/EN 60529 (IP rating for instrument by itself, with no cover). |

|                             |  |
|-----------------------------|--|
| <b>Temperature range</b>    |  |
| Operating, AC power, spec   | -10 to 55°C (14 to 131°F) (-10 to 45°C/14 to 113°F in RTSA mode) |
| Operating, battery, spec    | -10 to 50°C (14 to 122°F)  |
| Operating, battery, typical | -10 to 55°C (14 to 131°F)  |
| Storage, spec <sup>2</sup>  | -51 to 71°C (-60 to 160°F)                                       |

**EMC:** Complies with the essential requirements of the European Radio Equipment Directive as well as current editions of the following standards (dates and editions are cited in the Declaration of Conformity):

IEC/EN 61326–1  
 EN 301 489-1, EN 301 489-19  
 CISPR Pub 11 Group 1, Class B  
 AS/NZS CISPR 11  
 ICES/NMB–001

This ISM device complies with Canadian ICES-001.  
 Cet appareil ISM est conforme a la norme NMB-001 du Canada.

|                                |  |
|--------------------------------|--|
| <b>Radio Equipment (GNSS):</b> | Complies with the essential requirements of the European Radio Equipment Directive:<br>EN 303413 |
|--------------------------------|--|

<sup>1</sup> From 40 °C to 55 °C, the maximum % relative humidity follows the line of constant dew point.

<sup>2</sup> The battery packs should be stored in an environment with low humidity. Extended exposure to temperature above 45°C could degrade battery performance and life.

**SAFETY:** Complies with the essential requirements of the European Low Voltage Directive as well as current editions of the following standards (dates and editions are cited in the Declaration of Conformity):

IEC/EN 61010-1

---

Canada: CSA C22.2 No. 61010-1

---

USA: UL std no. 61010-1

---

To find a current Declaration of Conformity for a specific Keysight product, go to: <http://www.keysight.com/go/conformity>

#### **Explosive environment**

This product has been type tested to meet the requirements for operation in explosive environments in accordance with MIL-STD-810G, Method 511.5, Procedure I.

---

## General Information (continued)

|                                     |   |
|-------------------------------------|---|
| <b>Power supply</b>                 |   |
| External DC input                   | 15 to 19 VDC, 40 watts maximum when battery charging  |
| External AC power adapter           | Efficiency level IV   |
| Input                               | 100 to 250 VAC, 50 to 60 Hz, 1.25 to 0.56 A   |
| Output                              | 15 VDC, 6 A   |
| Power consumption                   | 14 watts typical, mode dependent  |
| <b>Battery</b>                      |   |
| Lithium ion                         | 10.8 V, 6.4 A-h, 70 Wh  |
| Operating time                      | 3.5 hours (typical), mode dependent   |
| Charge time                         | A fully discharged battery takes about 1.5 hours to recharge to 80%. Four hours to 100%.  |
| Discharge temperature limits        | -10 to 60°C, ≤ 85% RH   |
| Charge temperature limits           | 0 to 45°C, ≤ 85% RH   |
| Storage temperature limits          | -20 to 50°C, ≤ 85% RH<br>The battery packs should be stored in an environment with low humidity. Extended exposure to temperatures above 45°C could degrade battery performance and life.   |
| <b>Test port connectors</b>         |   |
| ≤ 18 GHz models                     | Type-N (f)  |
| 26.5 GHz models                     | 3.5 mm (m) for FieldFox microwave analyzer, N9918A and FieldFox microwave VNA analyzer, N9928A. On FieldFox SA N9938A, you may choose 3.5 mm (m) or Type-N (f). Type-N (f) port connector is not available for the 26.5 GHz microwave analyzer, N9918A or 26.5 GHz microwave VNA analyzer, N9928A |
| ≥ 32 GHz models                     | NMD 2.4mm (m), torque .9 Nm or 8 in-lb, use torque wrench N9910X-886  |
| <b>Display</b>                      |   |
|                                     | 6.5" transfective color LCD-LED backlit   |
| <b>Headphone jack connector</b>     |   |
|                                     | 3.5 mm (1/8 inch) miniature audio jack  |
| <b>USB-A, 2-ports</b>               |   |
|                                     | Hi-speed USB 2.0  |
| <b>Mini USB, 1 port<sup>1</sup></b> |   |
|                                     | Hi-speed USB 2.0; used for SCPI programming; USBTMC (USB IEEE488)   |
| <b>Keyboard</b>                     |   |
|                                     | USB keyboards are supported (user must supply their own keyboard)   |
| <b>LAN</b>                          |   |
| Connector                           | RJ-45<br>Used for programming, data saving, remote control, and connection to DataLink software   |
| N991xA, N992xA, N993xA              | 100/10 base-T (auto switching)  |
| N995xA, N996xA                      | 1000/100/10 base-T (auto switching)<br>SCPI over LAN using sockets and VX11 (LAN IEEE488); HTTP   |

<sup>1</sup> SCPI over USB for the N991x/2x/3x models is only available for serial number prefix starting with MY5607/SG5607/US5607 or upgraded with Option N9910HU-100/200/300/400.

## General Information (continued)

|                                  |   |
|----------------------------------|---|
| <b>Programming</b>               | SCPI, using the built-in LAN interface, BenchVue  |
| <b>Languages</b>                 | English, Spanish, German, Italian, French, Russian, Japanese, Chinese, Turkish, Korean, and Portuguese  |
| <b>Preset</b>                    | User preset for both mode preset and complete system preset   |
| <b>Limit lines</b>               | <p>The limit line capabilities listed in this section apply to the cable and antenna analyzer, network analyzer and spectrum analyzer modes in all FieldFox analyzers.</p> <ul style="list-style-type: none"><li>• Limit lines can be a combination of horizontal lines, sloping lines, or discrete data points</li><li>• Limit types: Fixed or relative</li><li>• Each trace can have its own limit line</li><li>• Limit lines can be built from a current trace</li><li>• Limit segments &gt; 100, limited by memory size</li><li>• Max limit line number of points: 10,001</li><li>• Beep: Beep off, Beep on fail, Beep on pass</li><li>• Pass/fail warning: on/off</li><li>• Offset and margin: An increase or decrease in the limit line</li><li>• Save/recall limit lines</li></ul> |
| <b>Data storage</b>              |   |
| Internal                         | Internal Minimum: 4 GB<br>Minimum states and traces: 1000   |
| External                         | Supports USB 2.0 compatible memory devices and SD/SDHC memory cards   |
| Data types                       | Trace, trace+state, picture (png), data (csv), S1P, S2P   |
| <b>Secure operation</b>          |   |
| Frequency blanking               | For protection of sensitive data all frequency information can be turned off.   |
| Erase user data                  | All user data can be erased on a FieldFox analyzer. For more information visit: <a href="http://www.keysight.com/find/securefieldfox">http://www.keysight.com/find/securefieldfox</a>   |
| <b>Reference out/trigger out</b> |   |
| Connector                        | SMB (m), 50 $\Omega$  |
| Output amplitude                 | $\geq 0$ dBm  |
| Frequency                        | 10 MHz (1 + frequency reference accuracy)   |
| Trigger out                      | Reserved for future use; currently only used for ERTA 2-box handshaking   |
| <b>Reference in/trigger in</b>   |   |
| Connector                        | SMA (f), 50 $\Omega$  |
| Reference input                  | 10 MHz, - 5 to +10 dBm  |
| Trigger input                    | 3.3 or 5 V TTL logic levels   |

# FieldFox Physical Dimensions

FieldFox models with Type-N test port connectors

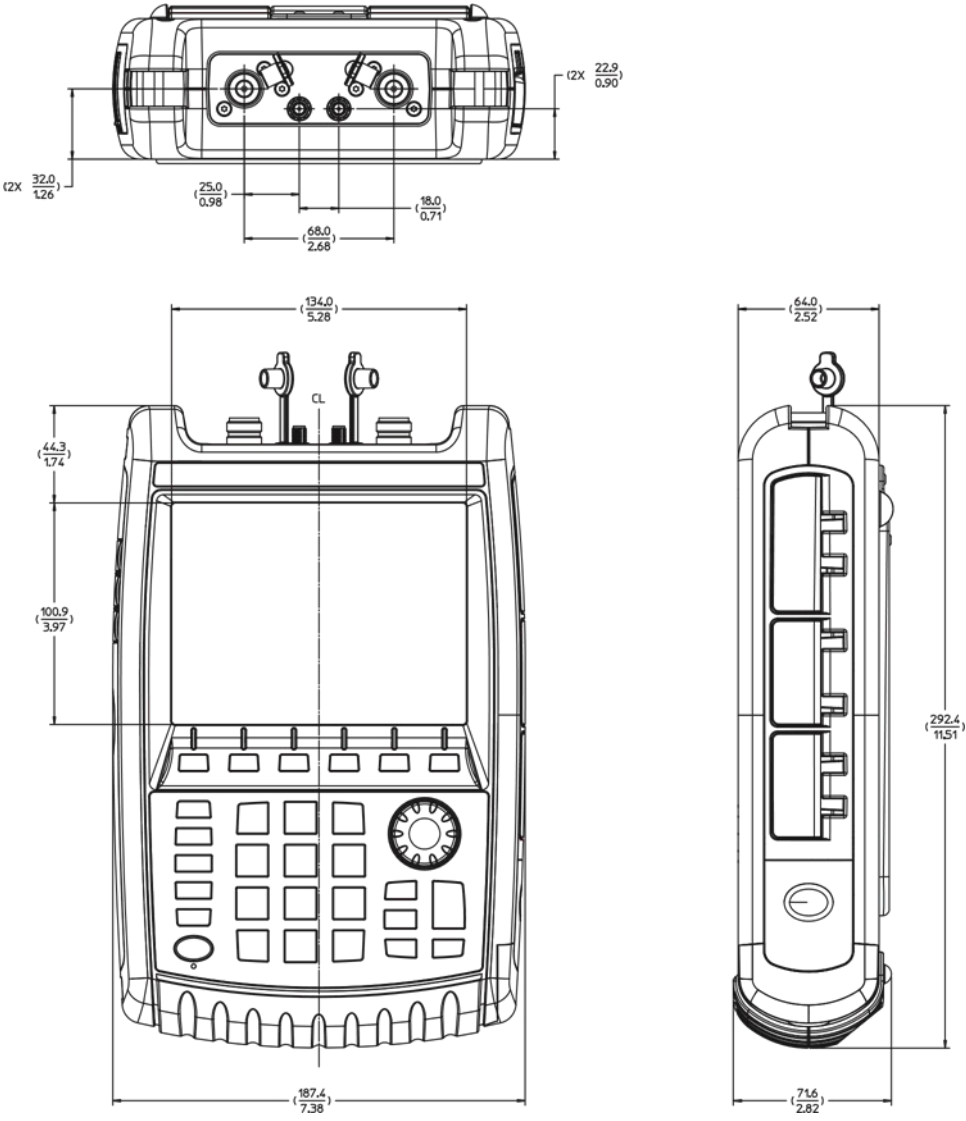

# FieldFox Physical Dimensions (continued)

FieldFox models with 3.5 mm test port connectors

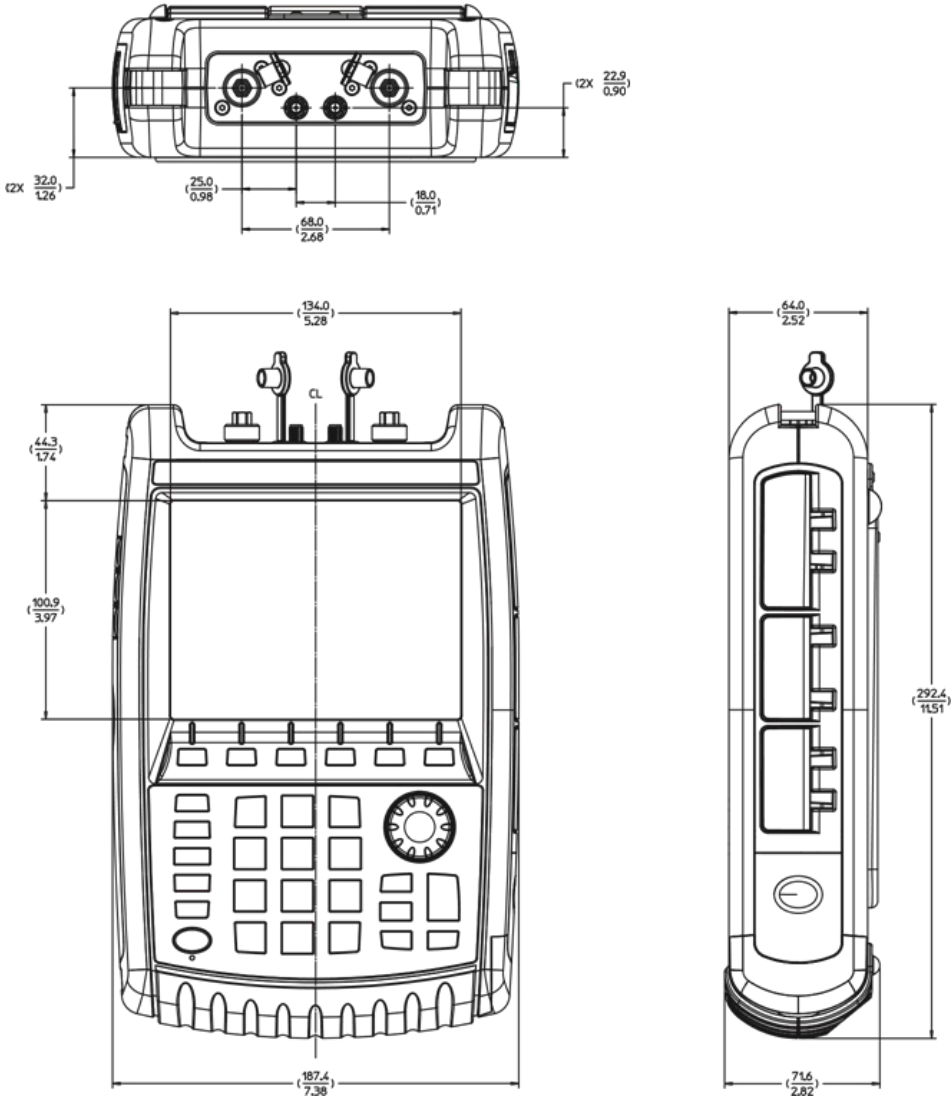

# FieldFox Physical Dimensions (continued)

FieldFox models with 2.4 mm test port connectors

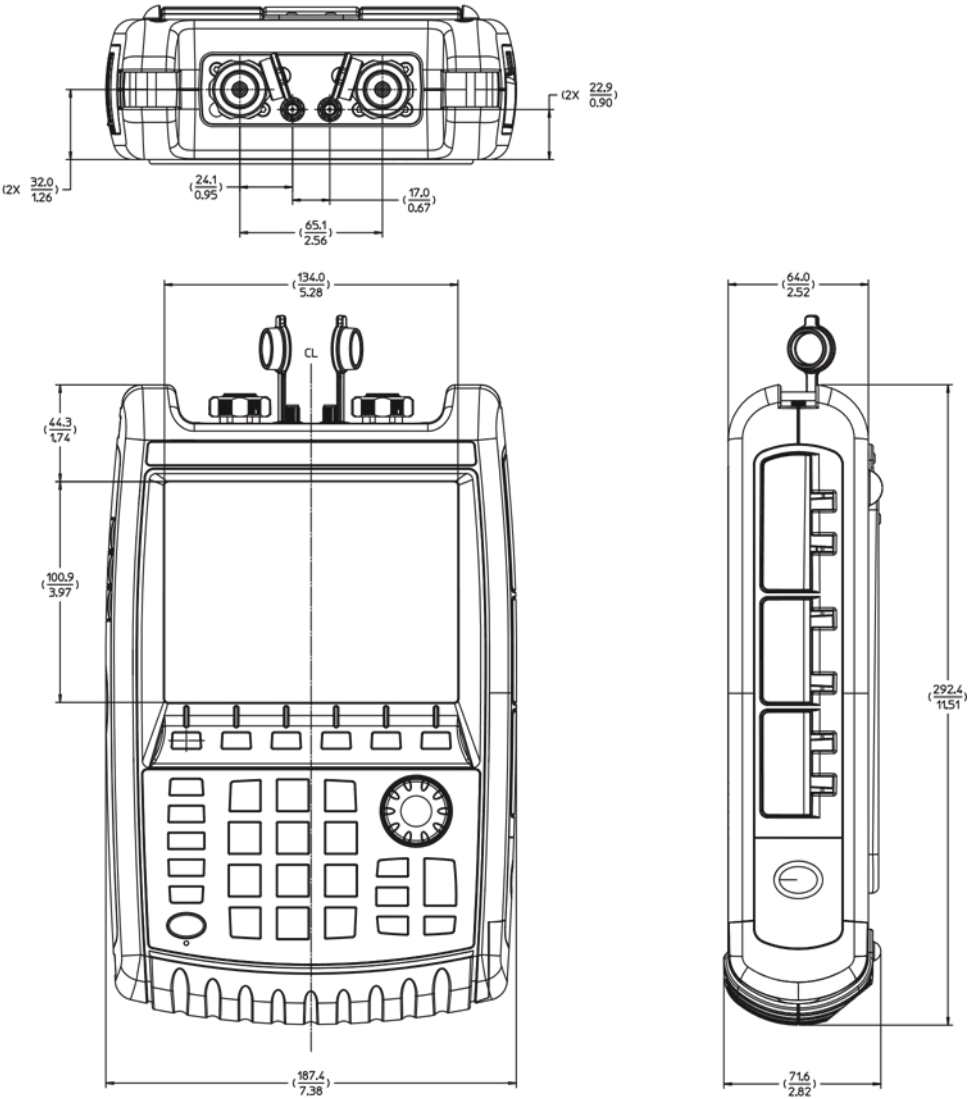



## Carry Precision with You

Every piece of gear in your field kit had to prove its worth. Measuring up and earning a spot is the driving idea behind Keysight's FieldFox analyzers. They're equipped to handle routine maintenance, in-depth troubleshooting and anything in between. Better yet, FieldFox delivers precise microwave measurements — wherever you need to go. Add FieldFox to your kit and carry precision with you.

| Related literature                               | Publication number |
|--|--------------------|
| FieldFox Handheld Analyzers, Configuration Guide | 5990-9836EN        |
| FieldFox Handheld Analyzers, Technical Overview  | 5992-0772EN        |



Mess- und Prüftechnik. Die Experten.

**Ihr Ansprechpartner /  
Your Partner:**

**dataTec AG**  
E-Mail: [info@datatec.eu](mailto:info@datatec.eu)  
>>> [www.datatec.eu](http://www.datatec.eu)



Find us at [www.keysight.com](http://www.keysight.com)

This information is subject to change without notice. © Keysight Technologies, 2014 - 2024, Published in USA, December 4, 2024, 5990-9783EN