

R&S® ESSENTIALS

# MXO 5 Series OSCILLOSCOPE

Next generation oscilloscope:  
evolved for more challenges

*dataTec*

Mess- und Prüftechnik. Die Experten.

Ihr Ansprechpartner /  
Your Partner:

**dataTec AG**

E-Mail: [info@datatec.eu](mailto:info@datatec.eu)

>>> [www.datatec.eu](http://www.datatec.eu)



Product Brochure  
Version 09.00

**ROHDE & SCHWARZ**

Make ideas real



# EVOLVED FOR MORE CHALLENGES

## GET THE BIG PICTURE AND ALL THE DETAILS

The MXO 5 series breakthrough oscilloscope technology speeds up understanding and testing of electronic systems. The MXO 5 series specifications stand out among oscilloscopes with impressive four and eight channel models.



4-channel model



8-channel model

Fastest acquisitions with  
4.5 million waveforms/s

Highest precision of  
12-bit ADC/18-bit HD resolutions

Deep memory capture with  
500 million points/channel

Highest sensitivity with  
advanced digital trigger

Increased visibility with  
15.6" Full HD touchscreen

## WHY ENGINEERS LOVE ROHDE & SCHWARZ OSCILLOSCOPES?

- ▶ A trusted, global high-quality company with a long-standing commitment to customers and continuous technological innovation
- ▶ The newest oscilloscope portfolio from 60 MHz to 16 GHz
- ▶ In-house ASICs developed for the world's most responsive oscilloscopes
- ▶ Frontend technology development for pristine signal integrity
- ▶ 18-bit architecture with HD mode for the highest resolution
- ▶ Digital triggers for the world's most sensitive event isolation
- ▶ Superior user interface and front panel that streamlines workflows

## WHY THE MXO 5 SERIES?

- ▶ **Evolution in speed:** Quick acquisitions with multiple channels, math functions and seamless spectrum measurements for minimal blind time with 21 ns rearm
- ▶ **Unleash comprehensive spectrum analysis:** Fast and pristine spectrum analysis and ability to run up to four analyses simultaneously
- ▶ **Extensive memory capacity:** Benefit from the deepest standard memory and up to 1 million waveform segments
- ▶ **Precise in-event detection:** Our digital trigger is flawless at 18-bit HD resolution with adjustable sensitivity for accurate triggering
- ▶ **Uncompromised performance:** A low noise floor and the largest vertical offset range of  $\pm 5$  V at 0.5 mV/div for exceptional signal fidelity
- ▶ **Setting new sensitivity standards:** the industry most sensitive trigger down to 0.0001 div
- ▶ **Leading trigger jitter performance:** Best-in-class trigger jitter of less than 1 ps

# CONTENTS

## FEATURES AND BENEFITS

### Compelling technology blocks

▶ page 4

### MXO 5 capabilities

▶ page 6

### Accelerated insights

▶ page 8

### Capture even more time

▶ page 9

### See signals accurately

▶ page 10

### Trigger on every detail

▶ page 11

### Fastest zone trigger

▶ page 12

### Multispectral evolution

▶ page 14

### Superior user experience

▶ page 15

### MXO 5 series at a glance

▶ page 16

### Convenient access

▶ page 18

### Intuitive user interface

▶ page 19

### Adapting to your work style

▶ page 20

### Sustainable performance

▶ page 21

### Your go-to tool

▶ page 22

## APPLICATIONS

### Optimizing power sequencing

▶ page 23

### Debugging power rails and switching characteristics

▶ page 24

### Power analysis made easy

▶ page 25

### Streamline your EMI debugging

▶ page 26

### Logic analysis

▶ page 27

### Analyze serial buses with protocol innovation

▶ page 28

### Automated compliance tests

▶ page 30

### Versatile integrated arbitrary waveform generator

▶ page 31

### Frequency response analysis with Bode plot

▶ page 32

## PROBES AND ACCESSORIES

### Extensive probe portfolio

▶ page 34

### And there is so much more ...

▶ page 36

- ▶ 100 MHz to 2 GHz bandwidth
- ▶ Up to 5 Gsample/s sample rate
- ▶ 500 Mpoints per channel standard memory
- ▶ 12-bit ADC at all sample rates
- ▶ 18-bit architecture with HD mode
- ▶ Precise digital trigger

# COMPELLING TECHNOLOGY BLOCKS

## EVOLVING ACCELERATED INSIGHT

The MXO 5 series oscilloscopes have cutting-edge technology for swift and precise results. Equipped with advanced custom technological and revolutionary features, these oscilloscopes are indispensable for insight into circuit behavior.



### **MXO-EP processing ASIC**

*See more of your signals, faster.*

Every MXO 5 series comes with two MXO-EP (extreme performance) Rohde&Schwarz application-specific integrated circuits (ASIC). The MXO-EP ASIC architecture processes 400 Gbit/s for the world's fastest update rate of up to > 4.5 million acquisitions/s and a total of 18 million waveforms/s on multiple channels. See and capture more signals, faster and find rare signal anomalies quickly with the most responsive oscilloscope in the industry.



### **12-bit ADC, 18-bit vertical architecture**

*Measure your signals accurately.*

The MXO 5 series has an incredibly low-noise signal path, powered by a channel-dedicated 12-bit ADC with no sample rate limitations. High definition mode (HD) enhances the vertical resolution to a remarkable 18 bit, ensuring unwavering accuracy in every measurement. With 10 effective number of bits (ENOB), ultra-low noise and a highly sensitive frontend, the offset voltage can be driven up to  $\pm 5$  V at the highest sensitivity. Get precise results and greater versatility.



### **Responsive deep memory**

*Capture more of your signals.*

MXO 5 series oscilloscopes come with the industry's deepest standard acquisition memory of 500 Mpoints per channel, for the highest sample rate capture of up to 200 ms of power up or power down sequences on eight channels. Get even longer recordings with the 1 Gpoints memory expansion.

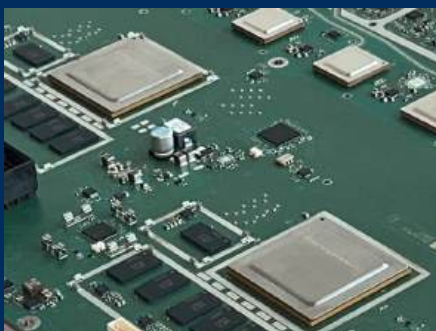

### **Advanced digital triggering system**

*Easily isolate subtle signal variations.*

The MXO-EP ASIC incorporates advanced digital triggering to evaluate ADC samples in the acquisition path in real time. Trigger on small events with vertical divisions of less than 0.0001 that no other oscilloscope can isolate. Choose your own trigger hysteresis. Apply digital filters to suppress noise for the most precise triggering available. The implemented zone trigger retains ultra fast acquisition speed and versatility and can work across channel waveforms, spectra and math signals.

# GET THE BIG PICTURE FASTER

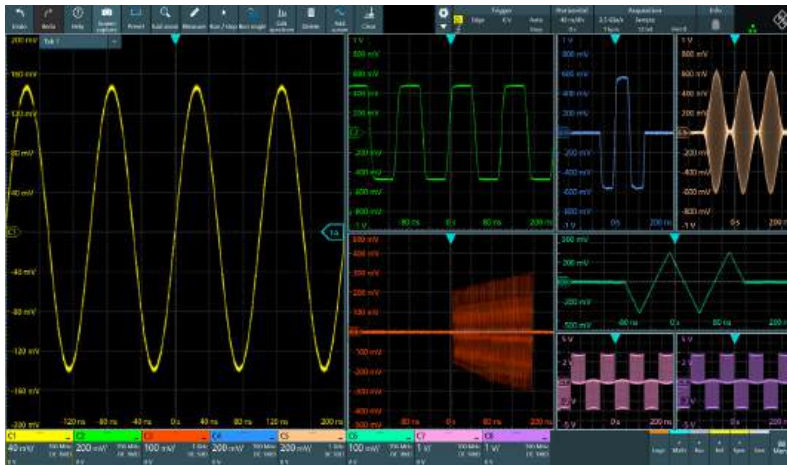

8 × time domain

See all traces with  
500 Mpoints per channel

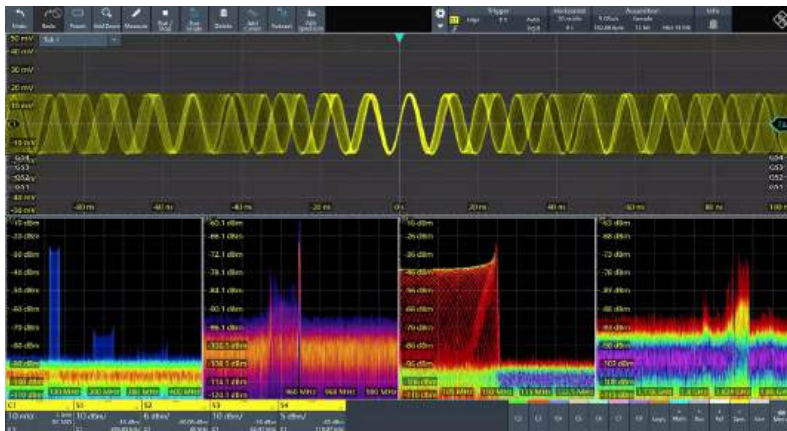

4 × spectrum domain

45 000 FFT/s to see  
all spectral events simultaneously

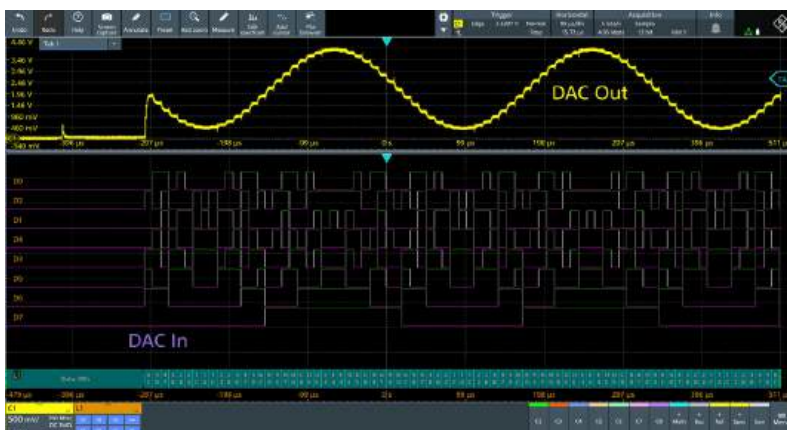

4 × protocol, 16 × logic channels

8 analog and 16 digital channels available  
for protocol decoding with deep memory  
to record system behavior for decoding up  
to 4 protocols simultaneously

# SEE SIGNAL DETAILS INSTANTLY

# MXO 5 CAPABILITIES

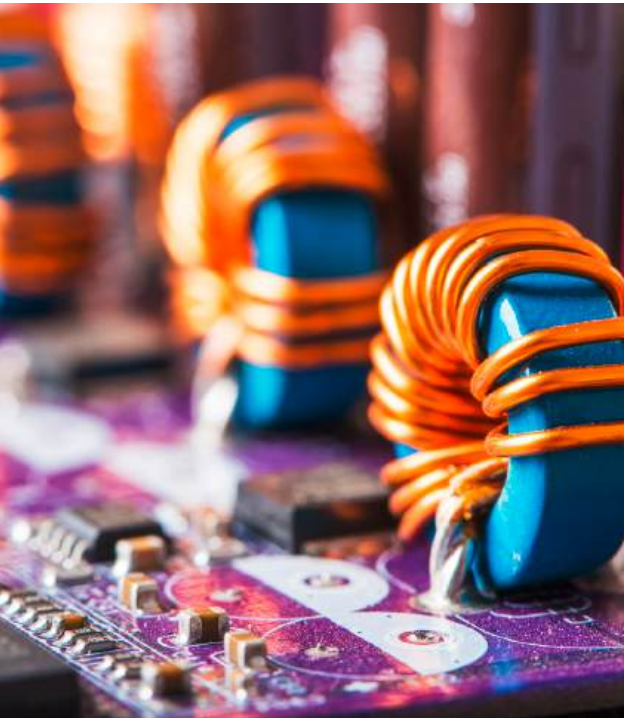

## POWER CONVERSION

Energy and power efficiency are critical to electronics design. Data centers, automotive electrification and renewable energy development are driving the growth of wide bandgap power semiconductors. To meet the next generation power research and development needs, the MXO 5 offers revolutionary power conversion testing performance and features.

Eight channels provide in-depth visibility of three-phase and six-phase motor drives and inverters. The MXO 5 supports up to eight active probes including concurrent high voltage differential and current probes. The 18-bit HD mode with digital trigger provides the ultimate resolution for accurate measurement and precise triggering.

The R&S®MXO5-K31 power analysis option enable quick and easy setup for harmonics and power quality measurements. The R&S®MXO5-K36 frequency response analysis provides bode plot and control loop analysis capabilities on the oscilloscope.

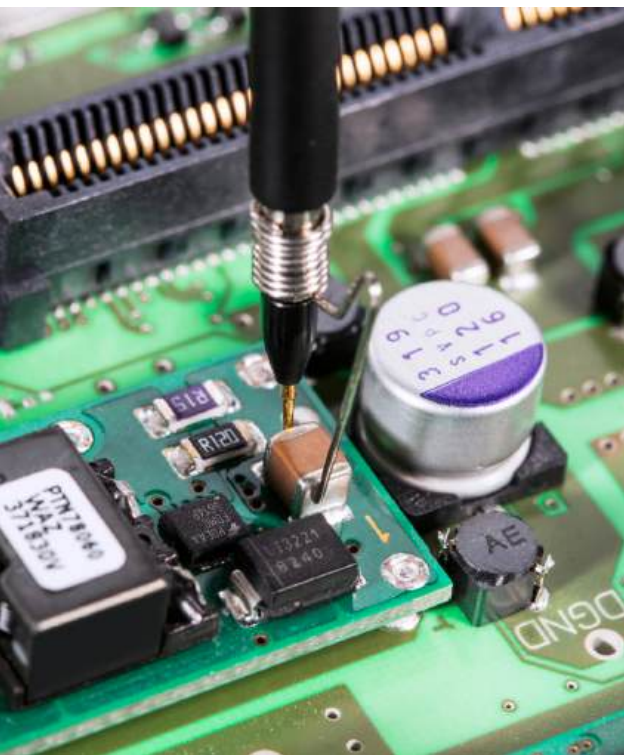

## POWER SEQUENCING AND INTEGRITY

All electronic circuits need to be power up and down at the right time with the proper power amplitude. Power sequencing can be complex and iterative. The MXO 5 can be used to concurrently observe up to eight analog channels and eight reference waveforms.

On top of the channel count, having enough memory is crucial to record over longer time periods and obtaining a large enough sample rate to observe small signal events. The MXO 5 comes with a standard 500 Mpoints.

To measure power ripple and noise, the MXO 5 has 5 V offsets with maximum sensitivity of 0.5 mV/div. Even with a 10x passive probe, 50 V range DC signals at 5 mV/div can be observed with high precision. When combined with fast spectrum, the MXO 5 is ideal for finding EMI issues and revealing spectral components for faster noise source identification.

The R&S®MXO5-K550 option lets the MXO 5 trigger and decode the SPMI protocols widely used for IC power management.

## AUTOMOTIVE ANALYSIS

The efficiency and drive power of electric motors and inverters are constantly evolving. Multiphase topologies require careful gate driver optimization. The eight channels in the MXO 5 can observe these PWM controlled gates. Tracked measurement functions and spectrum analysis can be visualized for insight into drive behavior.

In-vehicle networks in autonomous and smart cars are evolving from electronic control units (ECU) to domain controller networks, where high-speed interconnections are crucial for camera, lidar, radar, sensors and various vehicle controls. The MXO 5 series has the ideal bandwidth and analysis depth to assess basic compliance requirements as well as automotive protocol trigger decoding.

R&S®MXO5-K550 can trigger and decode 10BASE-T1S and 100BASE-T1 automotive buses.



## SIGNAL INTEGRITY AND DEBUGGING

The MXO 5 waveform acquisition of rate up to > 4.5 million can be used for signal testing where error detection is critical. The MXO 5 has nearly no blind time and can detect rare and random events that other oscilloscopes miss. Most importantly, the MXO 5 can maintain the acquisition rate with up to four channels activated. Basic measurements and math functions are hardware accelerated.

MXO 5 delivers four hardware-accelerated spectrum channels. With up to 45000 FFT/s per channel, the instrument can perform up to 180000 FFT/s. Quickly test and debug harmonic, EMI or other applications that require superior spectrum capabilities. The zone trigger and spectrum sources work together to generate the insight needed to capture elusive spectral events.

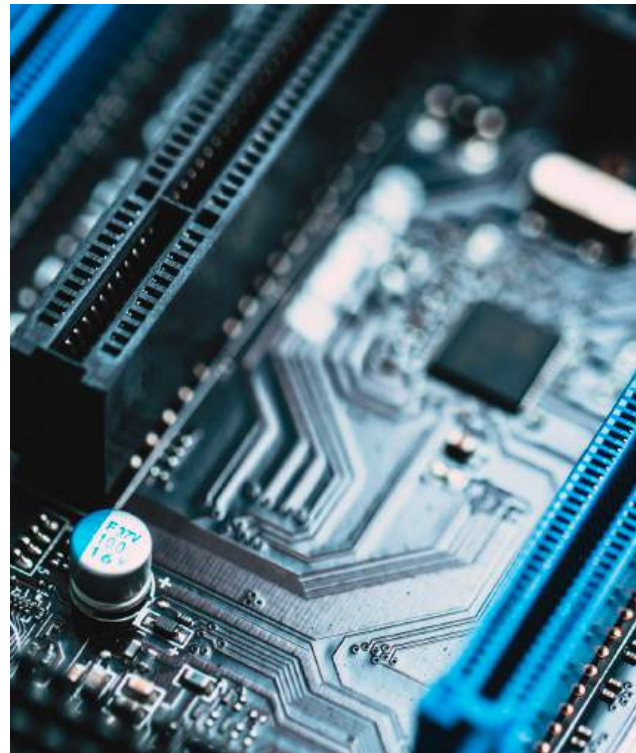

# ACCELERATED INSIGHTS

## FIND SIGNAL ANOMALIES QUICKLY

- ▶ World's first 8-channel oscilloscope with over 4.5 million acquisitions/s to instantly reveal infrequent anomalies
- ▶ World's first 8-channel oscilloscope with 18 million waveforms/s across multiple channels
- ▶ Up to 90% real-time signal capture, signal processing with MXO-EP ASIC and dedicated PC system for responsive analysis

### World's fastest update rate on eight channels

When running multiple channels with > 12-bit vertical resolution, competing oscilloscopes can struggle to keep up and the acquisition rate slows down. The oscilloscope is sluggish and has more blind time where it misses signal activity. All MXO 5 oscilloscopes processing paths include multiple MXO-EP (extreme performance) ASICs that minimize this effect.

### Real-time acquisition rate

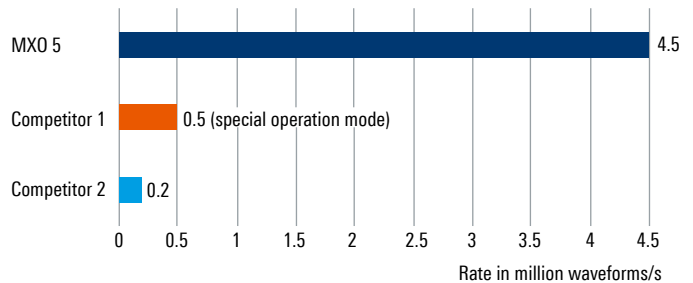

### Quickly and reliably detect sporadic signal faults

The high acquisition rate greatly improves the probability of finding rare and sporadic events that other oscilloscopes cannot. The MXO 5 can confidently capture all events even when the triggers are seemingly too close. With over 4.5 million waveforms/s, the MXO 5 series oscilloscope has the lowest blind time thanks to a trigger rearm of just 21 ns.



### Fast measurements to quickly correlate statistical results, FFTs or cursor measurements on eight channels

Quickly increase statistical confidence in results. High update rates increase the likelihood of detecting and displaying all signal activity, enabling the MXO 5 to generate trustworthy statistical results based on a high number of waveforms in a short time.

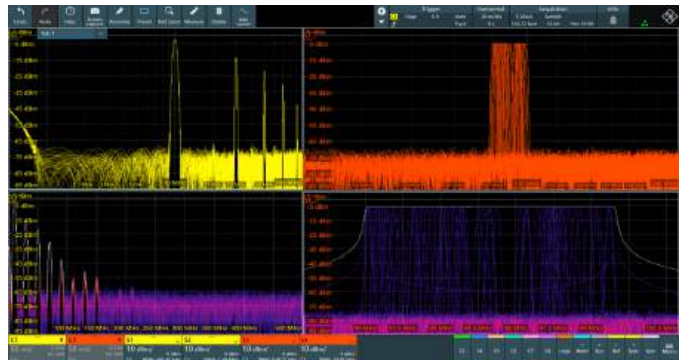



# CAPTURE EVEN MORE TIME

## DEEPEST STANDARD MEMORY ON EIGHT CHANNELS

- ▶ Industry's deepest memory of 500 Mpoints per channel (optional 1 Gpoints)
- ▶ Standard segmented memory (10 000 segments, optional 1 000 000 segments)
- ▶ Standard history mode (10 000 acquisitions, optional 1 000 000 acquisitions)

### More channels need more memory

After bandwidth and sample rate, memory depth is one of the most important factors when handling a large range of troubleshooting tasks. More memory lets oscilloscopes retain the maximum sample rate and bandwidth even with slower timebase settings. With 500 Mpoints of acquisition memory standard on all eight channels, the MXO 5 series oscilloscope has up to five times the standard memory of other oscilloscopes in this class.

### Standard memory per channel

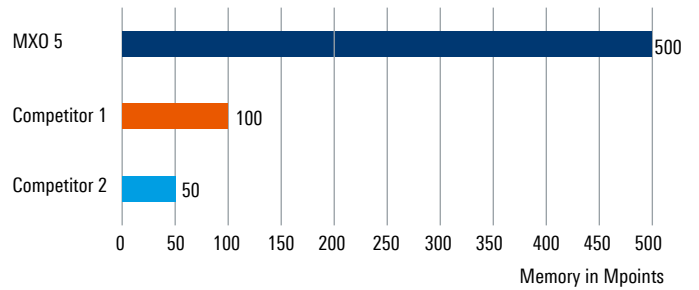

### Maintain fast sample rates with slow timebase settings

With limited memory, you often run into signal aliasing when capturing slow signals. The deep memory of the MXO 5 enables longer time to capture at the full sample rate. Even when observing slow events, the instrument retains enough of the sample rate to see the correct waveforms.

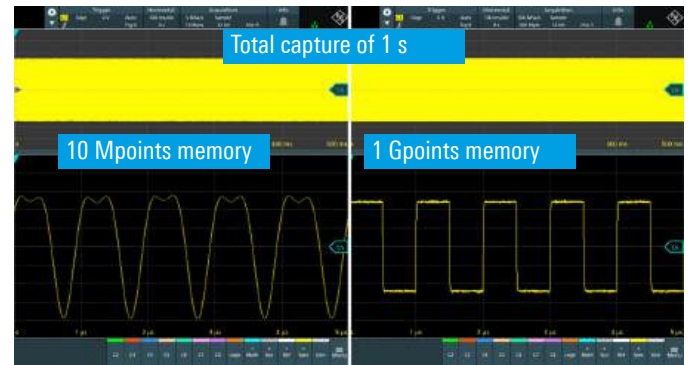

### Standard segmented memory

Use the segmented memory to capture signals separated by inactivity. Examples include laser pulses, serial bus activity and RF pulses. The segmented memory of the MXO 5 series can capture signals over long observation periods of up to 10 000 segments.

### Standard segmented memory

#### Protocol based signal with communications pauses

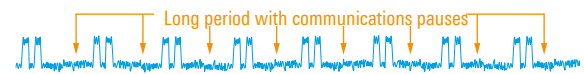

#### Single-shot acquisition

Conventional single-shot acquisition Missed acquisition due to limited memory

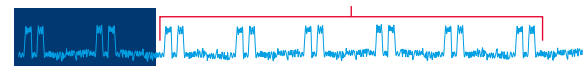

Acquisition of few pulses with many periods of inactivity

#### Acquisition using segmented memory

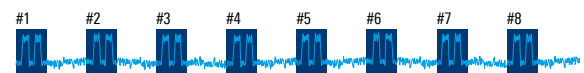

Acquisition of signal segments with activity

#### Analysis of each segment using the history function

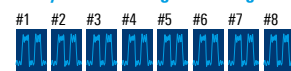

Display and analysis of each signal element

### Standard history mode

Press stop and use the history mode to see previously captured acquisitions. The history mode is always on. All measurement and analysis tools are available in the history mode, including serial bus decoding and automatic measurements.

### Need even more memory?

Need to capture even longer periods of time? The memory extension option activates 1 Gpoints (channels interleaved) for up to 1 000 000 segments and acquisitions.

# SEE SIGNALS ACCURATELY

## LOWEST MEASUREMENT NOISE AND HIGHEST VERTICAL RESOLUTION ON EIGHT CHANNELS

- ▶ 12-bit ADC for high vertical resolution at all sample rates with no tradeoffs
- ▶ 18-bit architecture with HD mode
- ▶ Low noise of 130  $\mu\text{V}$  at 1 mV/div at full bandwidth of 2 GHz
- ▶ ENOB performance of > 10 bit
- ▶ Industry's highest available offset range of  $\pm 5\text{ V}$  at 500  $\mu\text{V}/\text{div}$

### 12-bit ADC with 18-bit architecture for HD mode

MXO 5 series oscilloscopes incorporate a 12-bit A/D converter on all input channels. The 4096 quantization levels deliver precise vertical resolution at all sampling rates for uncompromising capture of signal details. The 18-bit architecture with HD mode also enhances the ADC resolution. The MXO 5 series has up to eight channels with 12 bit precision and an uncompromised sampling rate.

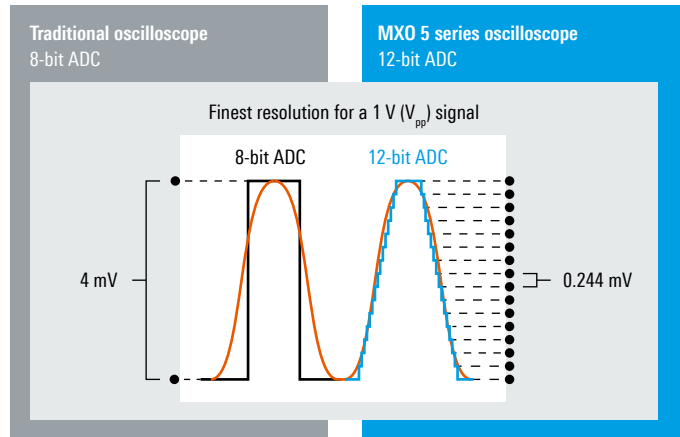

### HD mode improves noise no impact on sample rate

Vertical resolution enhancement averages adjacent samples and reduces the sample rate, leading to waveform issues such as aliasing. The MXO 5 HD mode in the hardware uses a moving average filter to remove aliasing. The HD samples are then fed into the triggering system, making high resolution, low noise signals available for precise triggering.

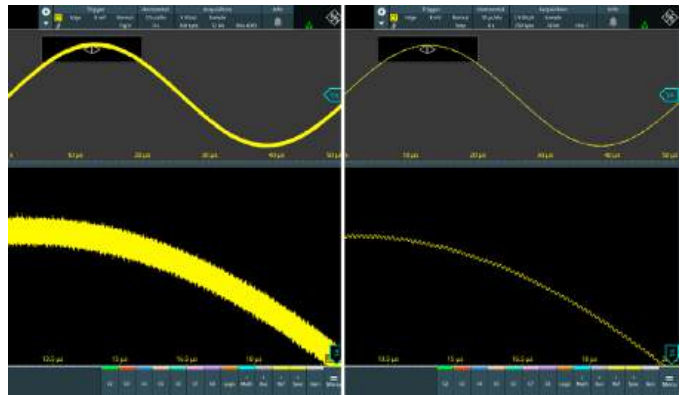

### Low noise with vertical sensitivity down to 500 $\mu\text{V}/\text{div}$

The MXO 5 series oscilloscope has outstanding sensitivity down to 500  $\mu\text{V}/\text{div}$  without any unexpected reductions in bandwidth. The offset of  $\pm 2\text{ V}$  on 50  $\Omega$  coupling and  $\pm 5\text{ V}$  on 1 M $\Omega$  coupling let you easily place the signal at the center of the screen to examine DC noise and ripple. The oscilloscope must have low noise levels to accurately quantify small signals.



# TRIGGER ON EVERY DETAIL

## HIGH PRECISION DIGITAL TRIGGER

- ▶ World's first 8-channel oscilloscope with trigger sensitivity down to 0.0001 vertical division
- ▶ World's first 8-channel oscilloscope with user adjustable trigger hysteresis
- ▶ World's fastest trigger rearm time of < 21 ns, capturing up to 99% of waveform
- ▶ Best-in-class trigger jitter of just 1 ps

### Modern digital trigger

The MXO-EP ASIC uses the most advanced digital trigger system in the industry, patented by Rohde&Schwarz. Digital triggering implies a common path for the measurement signal and trigger as opposed to a split path for older analog trigger architecture.

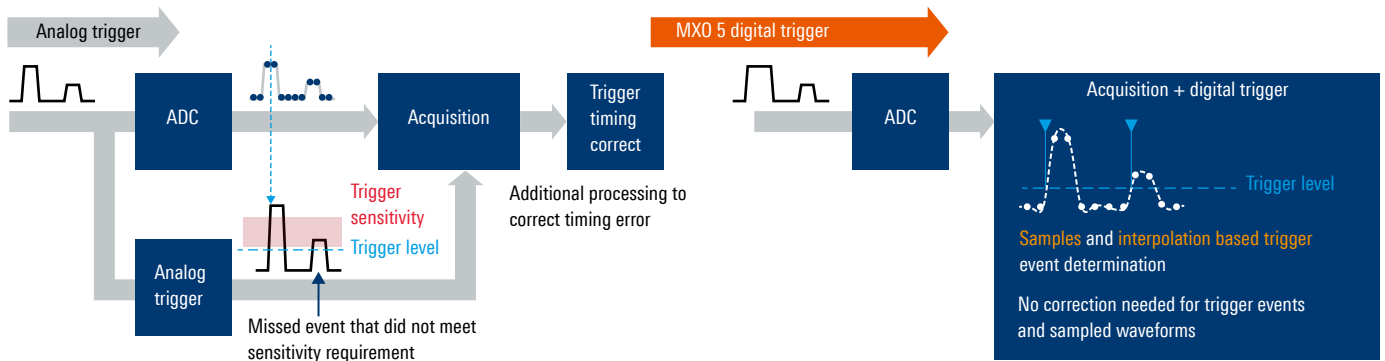

### World's most sensitive and hysteresis-adjustable trigger

The MXO 5 series digital trigger is up to 10000 times more sensitive than competing trigger systems. Triggering sensitivity lets you isolate difficult-to-find, small physical layer anomalies in the presence of large signals, speeding up debugging and troubleshooting. You have full control of the trigger hysteresis settings for added flexibility with desired trigger noise suppression.

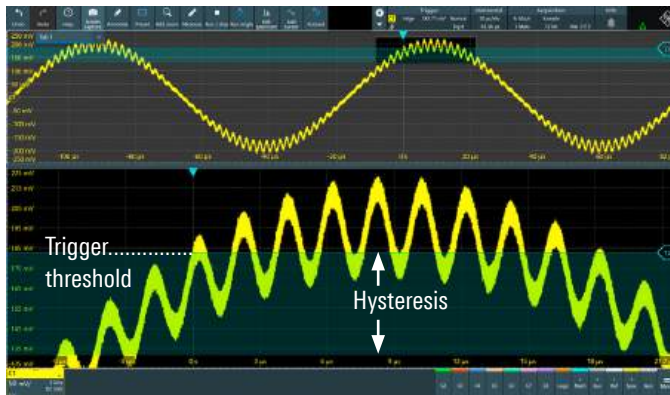

### Adjustable digital trigger filters

The 18-bit HD mode on the trigger reduces measurement system noise. The digital trigger architecture makes it possible to adapt the trigger system cutoff frequency. Conventional oscilloscopes limit triggering on filtered waveforms, on the MXO 5 the same filter settings can be used for both the trigger signal and the measurement signal. As a result, noise on the trigger signal can be suppressed for more stable capture.

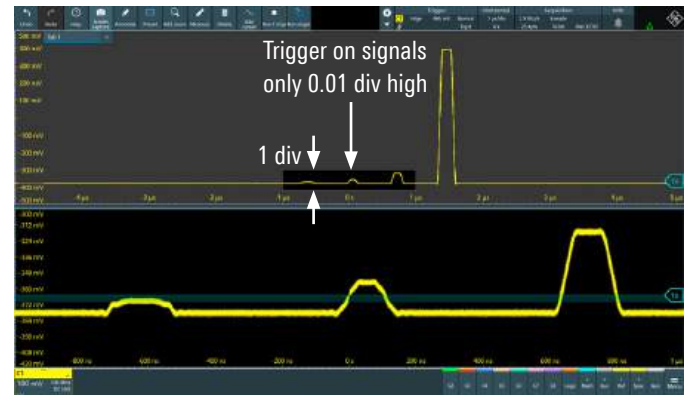

# FASTEST ZONE TRIGGER

## VISUALIZE TRIGGER EVENT GRAPHICALLY

- ▶ **Fastest zone trigger: 600 000 waveforms/s**
- ▶ **Draw a total of 32 zone areas: 4 zones with 8 zone areas each**
- ▶ **Zone trigger across analog, spectrum and math sources**
- ▶ **Combine zone trigger with history and segmentation mode**
- ▶ **Compatible with FreeRun triggering**

### Easy trigger condition setup visually as standard feature

Designs are becoming more complex and predefined trigger conditions may no longer effectively capture needed events. The zone trigger on MXO series oscilloscopes can easily be drawn on signal diagrams to specify whether traces have to pass through defined areas to qualify. Simply activate the function on the toolbar and draw the area on an analog waveform, spectrum or even math to define complex trigger conditions.

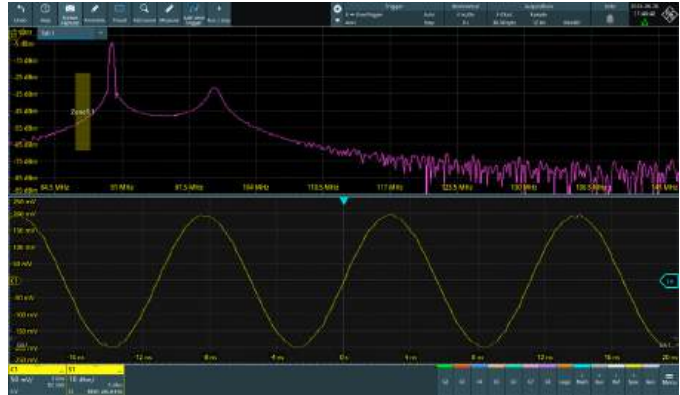

### Spectrum zone trigger

Rohde&Schwarz is the first in the industry to offer zone trigger capability for spectrum analysis. Starting with the R&S®RTO series, the MXO series has an even higher update rate for detecting spurious spectrum events. The responsive spectrum makes it ideal for EMI debugging. The fast zone trigger on the MXO series goes a step further and offers trigger capability across time, spectrum and even math waveforms.

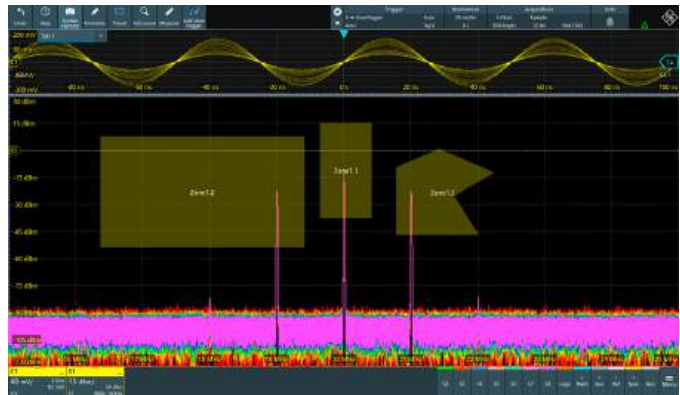

### 32 zone trigger areas across analog sources, spectrum and math

Graphically define 32 zone areas (4 zones with up to 8 areas each) on the screen. You can use the MXO series zone triggering for analog signals, math functions, spectra and zoom windows. Combine zone trigger with the oscilloscope FreeRun trigger mode to capture signals as quickly as possible without looking for a hardware trigger event.

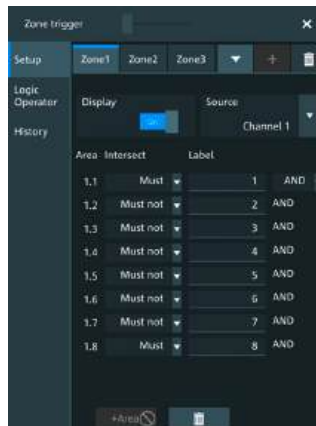

### Hardware accelerated zone trigger

Zone triggering complements traditional oscilloscope triggering to quickly and graphically isolate events. The MXO series zone trigger is implemented in the ASIC, the only hardware-accelerated solution and the fastest on the market with an update rate of 600 000 waveforms/s and less than 1.45  $\mu$ s blind time between trigger events. The solution is up to 10 000x faster than competing zone triggering products. A more complex trigger setup with fast waveform acquisition is possible and increases the probability of isolating rare events without affecting responsiveness.

### Complex HD trigger with zone logics

The MXO digital trigger can use the HD enhanced samples together with the zone trigger. Zones defined can also work across different sources. Logical definitions can enhance detection of required events.

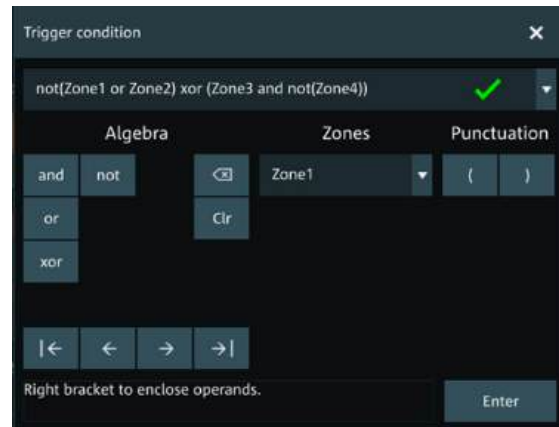

### Store zone trigger events in history

Apply zone triggering capability to history and segmentation mode and store only waveforms that match the zone trigger criteria in the oscilloscope memory. Very long time captures are possible when combined with the MXO series deep memory.

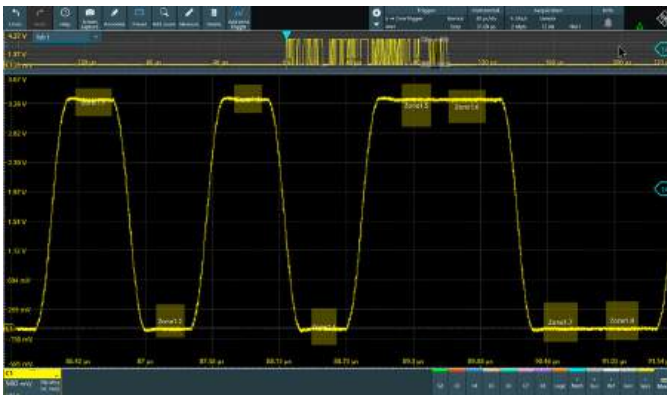
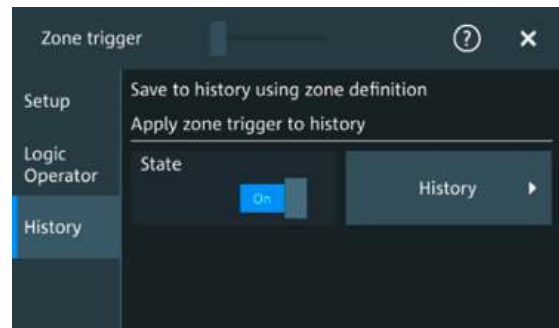

Use zone trigger on protocols to trigger on a specific packet sequence



Power rail measurements with zone trigger to isolate power consumption events during RF transmissions

# MULTISPECTRAL EVOLUTION

## PRISTINE RF MEASUREMENTS, NOW WITH MORE CAPABILITIES

- ▶ World's first 8-channel oscilloscope with 4 spectra and independent time and frequency control
- ▶ World's first 8-channel oscilloscope to achieve 45 000 FFT/s
- ▶ RF and time domain views with independent controls
- ▶ Industry best spectrum capabilities comes standard with each MXO 5

### More RF insights into your measurements

Improve overall RF insights with up to four highly capable, simultaneous spectrum displays. The powerful MXO-EP ASIC architecture and additional processing capabilities give the oscilloscopes ultrafast 45 000 FFT/s on up to four simultaneous spectrum displays.

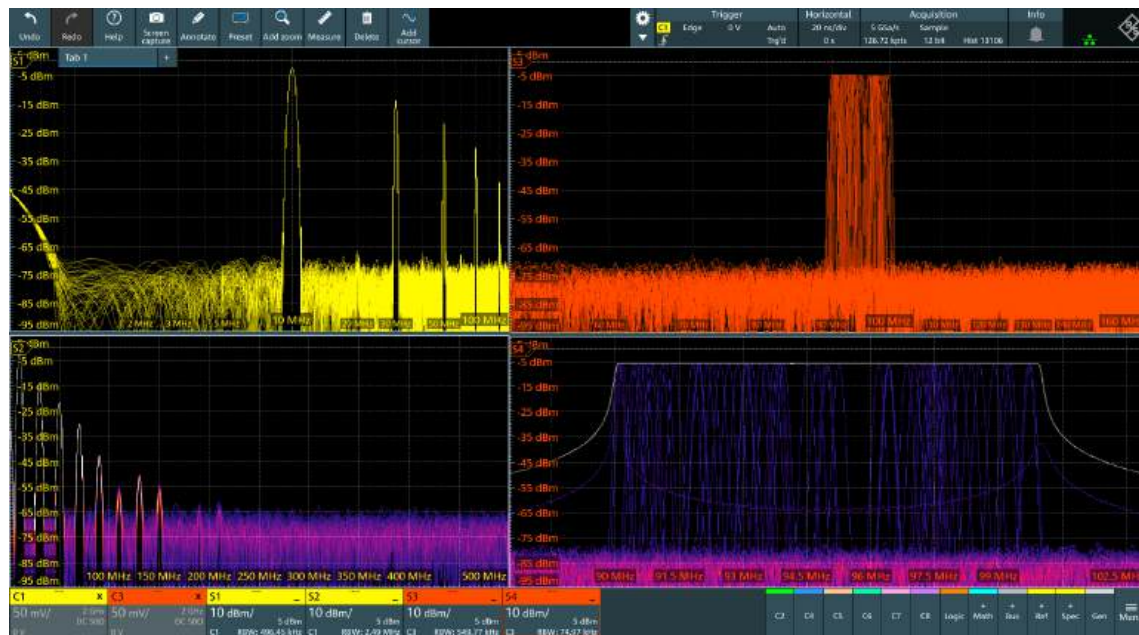

### Spectrum domain done right

The superior RF performance outshines all oscilloscopes in its class. The deep record length and spectral control independent of the time domain waveforms make RF analysis a breeze. The wide frequency range and low noise density generates a truly usable spectral trace for RF insight.

### Peak list and max./min. hold traces and log-log scales

As with a spectrum analyzer, spectral traces are easy to configure along with navigation to presentations of various spectral results such as max. and min. hold, or even an average trace to clean up noise. The MXO 5 also has log-log scale presentations to help observe EMI related spectral events in wide frequency ranges.

RF characteristics	
Simultaneous spectrum	up to 4 possible
Spectrum update rate	45 000 waveforms/s
Sensitivity/noise power density	-160 dBm (1 Hz) (meas.)
Noise figure	14 dB (meas.)
Dynamic range	106 dB (meas.)
Spurious-free dynamic range (SFDR)	65 dBc (meas.)
Second harmonic distortion	-60 dBc (meas.)
Third harmonic distortion	-59 dBc (meas.)

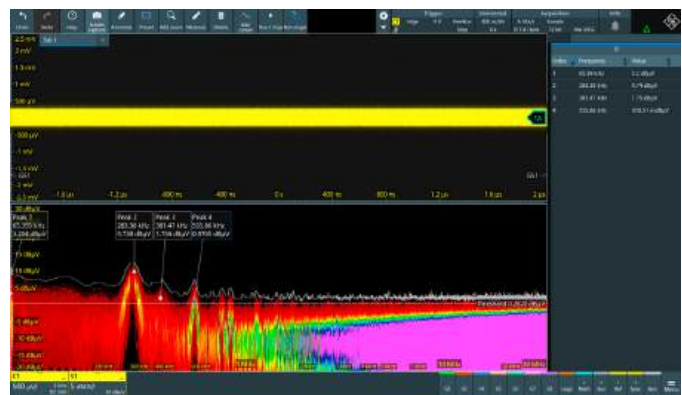

# SUPERIOR USER EXPERIENCE

## TOOLBAR, ADVANCED USABILITY AND R&S® SmartGrid

### Quick access to important tools

The toolbar **1** enables quick access to important tools. 28 different tools can be arranged with maximum flexibility. You can access all the settings with the main menu **2**. Signal activators on the left of the main menu **3** can be used to activate the desired signals and give quick access to the analog channel, math functions, FFT, signal generator and serial bus setup. Almost all elements in the user interface (UI) are interactive and quickly open menu dialogs.

### Touch screen enhances usability

The MXO 5 series user interface (UI) has a touch-screen. When there are too many elements in a waveform diagram, the oscilloscope's simple touch screen may cause you to select the wrong element. A pop-up selection **4** provides a list of interactive elements to help you select the right item. The large touch field design **5** for all instrument settings has enhanced capabilities. Pressing any part of a box will change a parameter value.

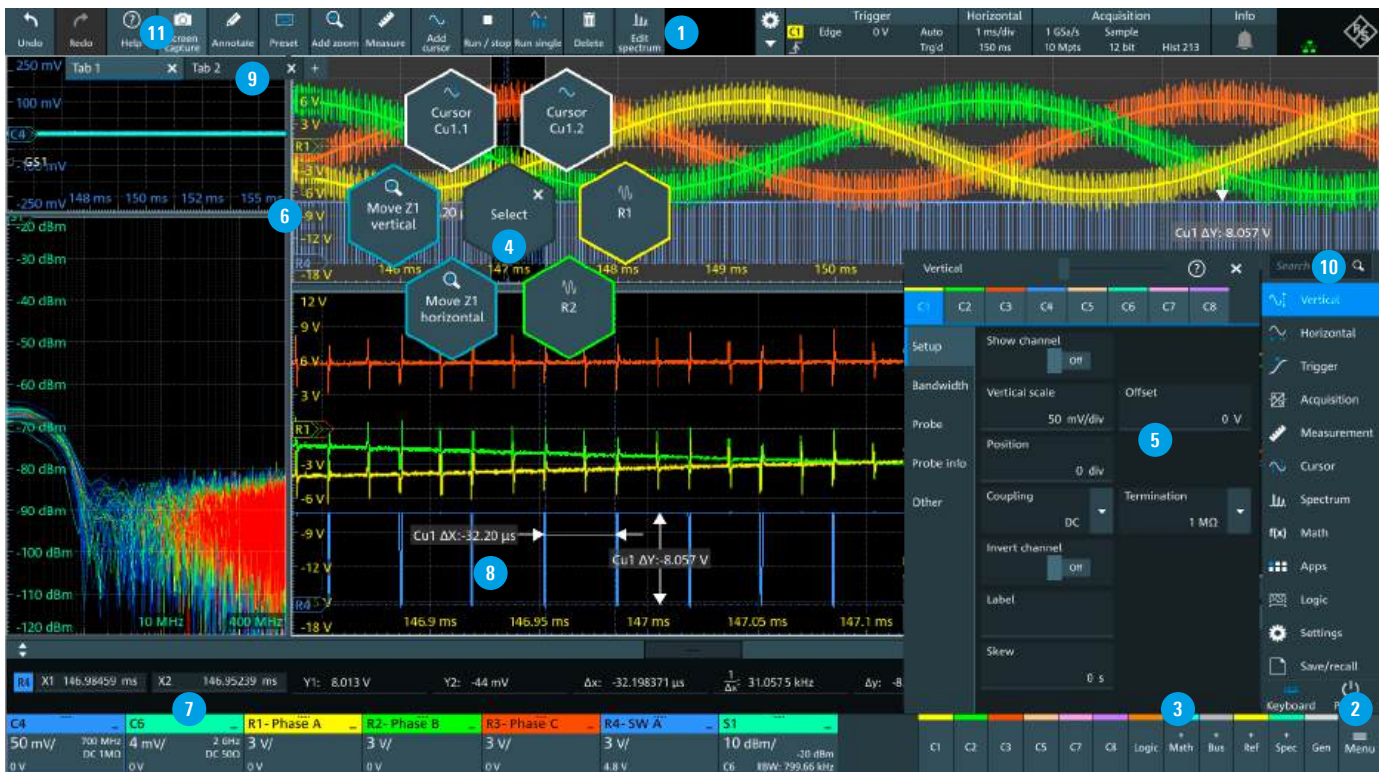

### Configurable layout

The R&S® SmartGrid function **6** generates an individualized waveform layout. See the fundamental signal parameters in the signal icon **7**. Then drag&drop waveforms and result tables into the desired location to change the waveform layout. Cursor labels can be adjusted to better indicate the measured results on the diagram **8**. The tab display **9** also stores user settings and allows fast toggling to different layouts for easy reporting.

### Minimized learning curve

Engineers can very quickly learn and master the MXO 5 series UI. Find any oscilloscope function you need by simply typing it into the search menu **10**. Press the help button on the toolbar **11** to open the help menu that lists the functions and their SCPI commands.

# MXO 5 Series AT A GLANCE

## 15.6" high resolution, multitouch display

- ▶ High resolution: 1920 × 1080 pixel (Full HD)
- ▶ Gesture support speeds up scaling and zooming
- ▶ Easy-to-see signal details



## Interfaces on front side

- ▶ Three USB 3.0 ports
- ▶ MSO logic probes inputs

## Active probe interfaces

- ▶ Support for over 30 Rohde & Schwarz current and voltage probes
- ▶ 50 Ω and 1 MΩ path enable support of an even wider range of passive and active probes, including ones from third parties





### Integrated arbitrary waveform generator

- ▶ Two-channel 100 MHz arbitrary waveform generator
- ▶ Wide range of waveforms and modulation types
- ▶ Easy configuration of frequency, amplitude, offset and noise

### Clear orientation with color-coded LEDs

- ▶ Color-coded keys and knobs for fast correlation with signal sources
- ▶ Indication of currently selected channel
- ▶ Simple election between fine/course adjustment

### Connections pairs

- ▶ Five USB 3.0 host ports
- ▶ USB device port
- ▶ HDMI DisplayPort video output



### Intuitive front panel increases productivity

- ▶ Fast, direct access to primary instrument settings
- ▶ Quickly adjust settings with knobs and keys
- ▶ Sectional layout makes finding the right function easy

# CONVENIENT ACCESS

## EFFICIENT INSTRUMENT INFORMATION

### Save results fast

Save waveforms in various file formats or download them via Ethernet or USB for later analysis with MATLAB or Excel. Continuous acquisition, analysis and transmission to a PC is possible via Ethernet.

### Documentation at the press of a button

Document your measurements quickly:

- ▶ Screenshots with waveforms and results
- ▶ Reports with screenshots and instrument setup
- ▶ Clear grid annotations for easy-to-read signal characteristics
- ▶ Color-coded annotation highlights signal anomalies
- ▶ Save waveforms and measurement results in binary, XML or CSV format available for signal analysis on a PC



### Remote control access: anytime, anywhere

Remotely control the oscilloscope and view the display on a PC or mobile device. View the same user interface as on the instrument itself. All oscilloscope functions are also available remotely via Ethernet or the USB-TMC interface. LabVIEW, VXI and Python instrument drivers are available.



### Language selection

The MXO 5 series user interface supports multiple languages. Just a few seconds are needed to switch languages while the instrument is running. Available languages include English, German, Japanese, Korean, Chinese and Spanish. Searches will also work in different languages.

### WebDAV support

You can easily access instrument data through the web distributed authoring and versioning (WebDAV) protocol to share, copy, move and edit files on the instrument through a web server. A WebDAV client can be a file transfer client or file manager like Dolphin or Nemo in Linux, Finder in Mac OS X and File Explorer in Windows. They are all capable of accessing the device through IP addresses or hostnames of devices.

# INTUITIVE USER INTERFACE

## PLEASANT USER EXPERIENCE

### Superior usability

Extensive user feedback, competitive comparisons and vast amounts of research into the latest user interface concepts outside of the test and measurement field helped in the development of the MXO 5 user interface:

- ▶ Navigate to anywhere from the pull-up menu in the lower left corner. Positioned close to the display area, you can minimize hand movement when switching between the two.
- ▶ Left-hand tab dialogs require small areas, magnifying the waveform view
- ▶ Anywhere-in-box touch allows you to activate a control by touching a large target area
- ▶ Signal icons make it easy to turn on/off sources and to adjust the R&S®SmartGrid layout
- ▶ Unique in the industry, the tool bar has quick access productive tools
- ▶ The toolbar space can be used to modify existing elements such as cursors, measurements and spectrum settings, or to quickly delete elements
- ▶ Fast one-touch access to trigger, horizontal, acquisition and info settings
- ▶ Select the Rohde&Schwarz icon to see current instrument details including LAN IP and firmware version
- ▶ UI consistent with the MXO 4, MXO 5C, R&S®RTO6 and R&S®RTP oscilloscopes

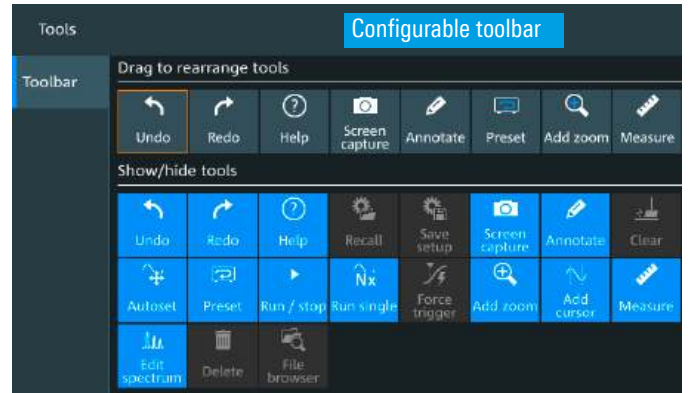
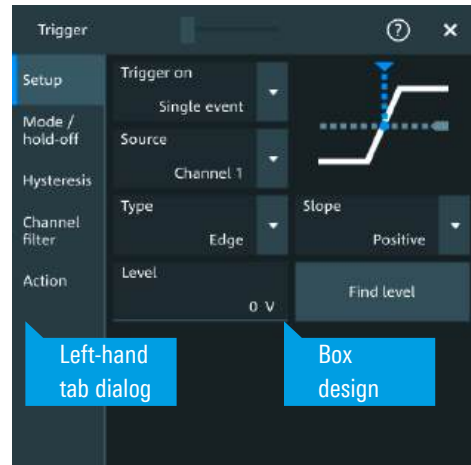

MXO 4



MXO 5



R&S®RTO6



R&S®RTP



MXO 5C



# ADAPTING TO YOUR WORK STYLE

## SEAMLESSLY OPTIMIZED TO WORK ALONGSIDE YOU

### Free up your bench

Space on lab benches is always tight. The optional R&S®MXO5-Z7 VESA mounting plate uses a commercial-off-the-shelf VESA mount. Float your oscilloscope above the bench to free up space. Weighing only 9 kg, it is the lightest in its class and can be used with standard VESA display monitor mounts.

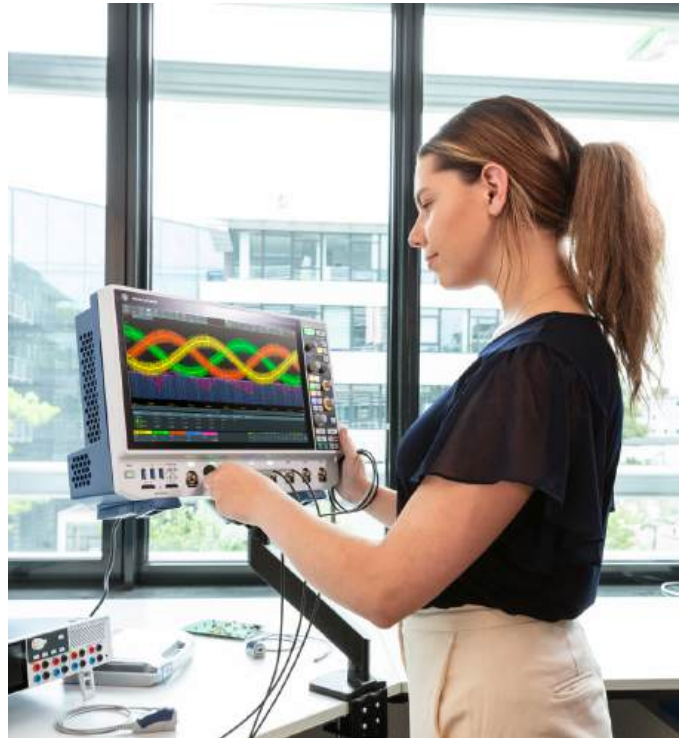

### Peace and quiet

Need a quiet space? Do loud instruments disturb others? Loud equipment? With an operating audible noise level of merely 25 dBA when 1 m from the instrument, the MXO 5 series sounds like a soft whisper. You might not even notice that it's turned on.

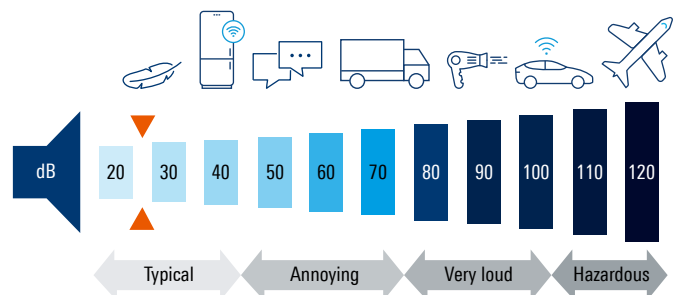

### Removable M.2 memory

If security is a priority, there is no better method for protecting instrument information than physically storing it in a secure location. The MXO 5 series supports removable M.2 memory cards. When working in a secure lab, simply add M.2 drives and secure them as needed.



# SUSTAINABLE PERFORMANCE

## KEEP POWER CONSUMPTION IN CHECK

### Reduce power consumption

Reducing power consumption is important now and in the future. The electrical power used over the lifecycle of an electronic device can make up 90% of its CO<sub>2</sub> footprint. Minimizing power consumption reduces an oscilloscope's environmental impact. Rising energy prices make reducing power consumption essential to long-term affordability.

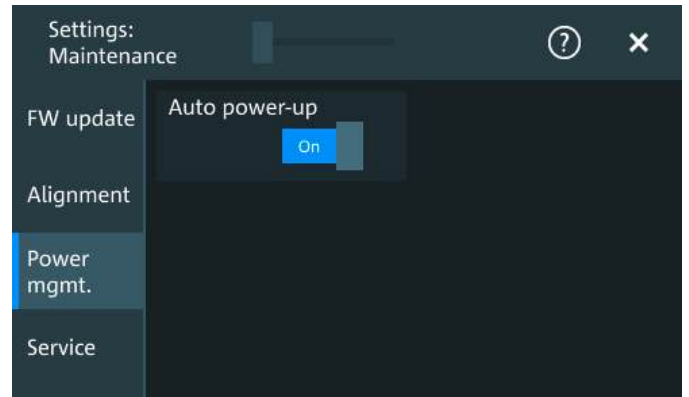

### Remotely turn on/off your Rohde & Schwarz oscilloscope

When working remotely, keeping the unit powered in the lab 24/7 can waste a lot of energy. While remote IP controlled socket power supplies are possible, most electronic equipment will only power up to a standby state with the main power switched on. The MXO 5 provides a convenient feature that allows it to be turned on automatically as soon as electric power is switched on. By simply connecting it into a smart socket system, you can enable the option of remotely turning on the device only when you intend to use it, while keeping it powered off at other times.

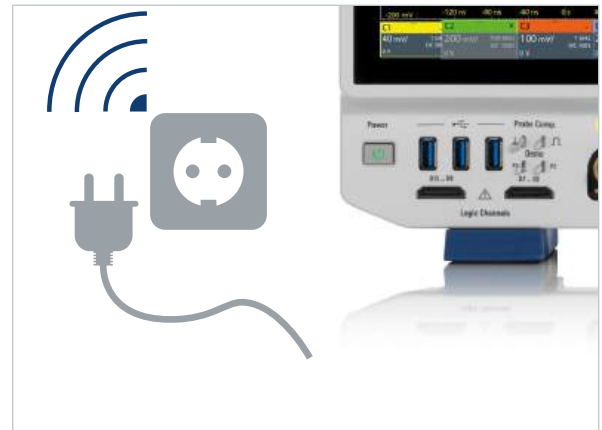

### Maximum performance, minimum consumption

Compared previous oscilloscope generations<sup>1)</sup>, the MXO 5 reduces standby consumption by a remarkable 40%. More impressive is that despite doubling the number of channels, enlarging the display, and exponentially increasing acquisition performance, typical power consumption remains almost unchanged<sup>2)</sup>.

<sup>1)</sup> Evaluations performed with the R&S®HMC8015 power analyzer.

<sup>2)</sup> Compared with the R&S®RTE1024.

### Standby power consumption

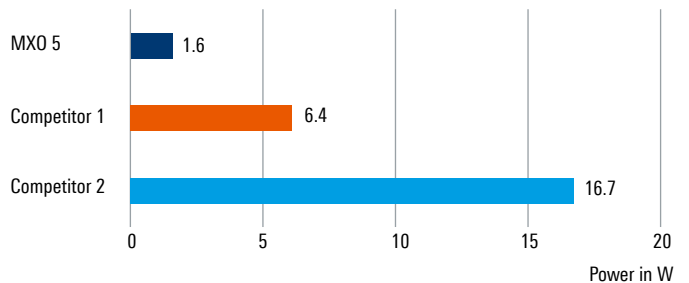

# YOUR GO-TO TOOL

READY FOR MANY USES

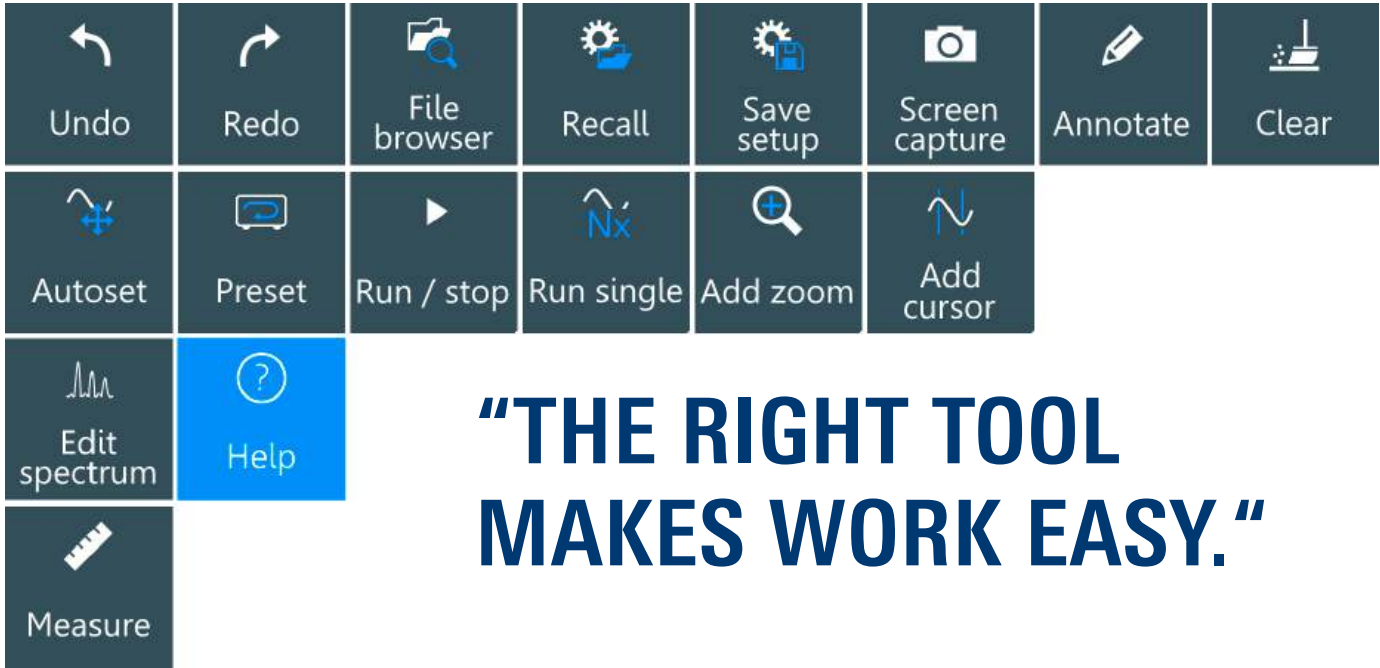

**“THE RIGHT TOOL  
MAKES WORK EASY.”**

Germans like to say that with the right tools make work easy. The MXO 5 series has many tools and features that help you be more productive.

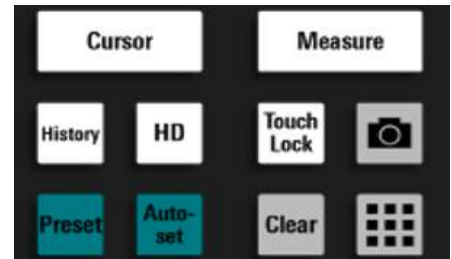
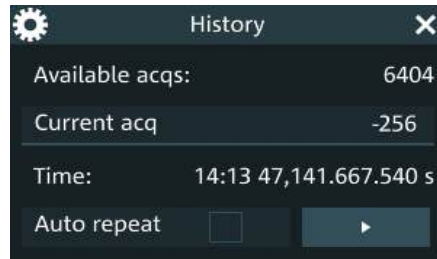
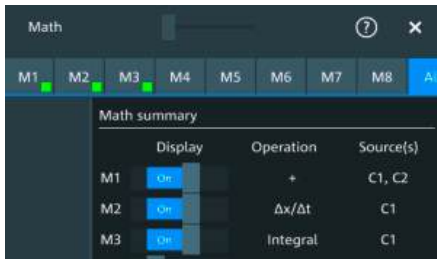

# OPTIMIZING POWER SEQUENCING

## Unparalleled power rail measurements

Do you need measure power sequencing for more than four power rails simultaneously? The MXO 5 series oscilloscope precisely measures power rail ramp up and ramp down. The oscilloscope's advanced capabilities can be used to correlate power sequencing events with other system activities. An additional 16 logic channels let you include key timing signals for further analysis. The deep memory feature ensures that the oscilloscope maintains sufficient bandwidth throughout sequences that last tens of milliseconds. Moreover, the R&S®SmartGrid function makes the arrangement of power rails easier to interpret and document.

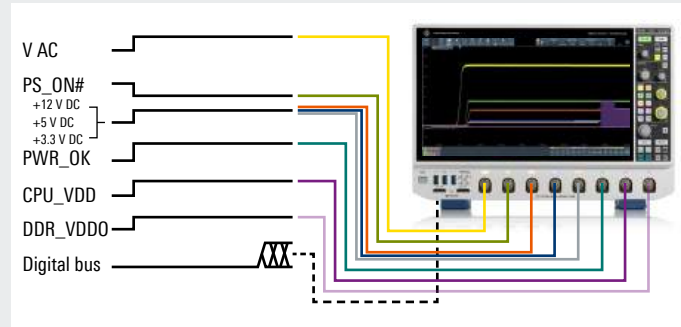

Sampling rate	Duration (500 Mpoints)	Duration (1 Gpoints)
5 Gsample/s	100 ms	200 ms
500 Msample/s	1 s	2 s
5 Msample/s	100 s	200 s
8 ksample/s	60500 s	1 d 10 h 43 s

## Flexible measurement setup

In power-related timing scenarios, delving into the specific details of where the measurement begins and ends is crucial. The MXO 5 incorporates configurable measurement reference levels and flexible gating functions for accurate measurements at the desired points. Such configurability enables precise analysis of bias voltage and gate thresholds and serves as a reliable reference for measurements.

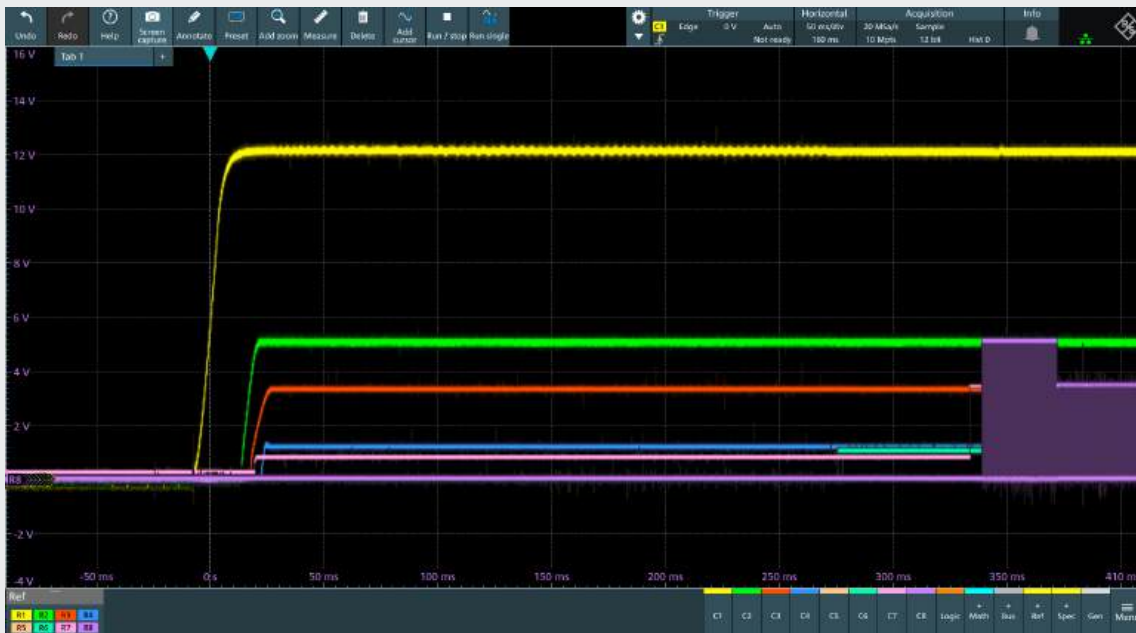
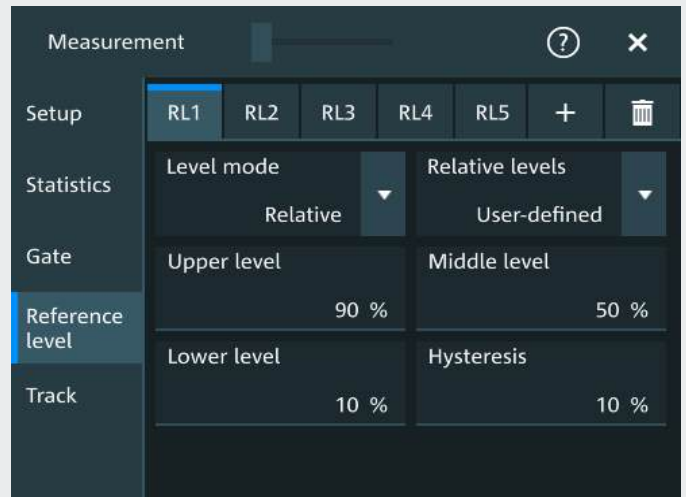

# DEBUGGING POWER RAILS AND SWITCHING CHARACTERISTICS

## Accurately measure ripple and PARD

The MXO series excels in precise measurements of power noise and ripple. The low noise capability ensures accurate power integrity measurements, even at the millivolt level. The oscilloscope stands out with a fast update rate and the unique FreeRun triggering feature for quick identification of infrequent and worst-case ripple, as well as periodic and random disturbance (PARD) anomalies. The uncompromised automatic measurements of the MXO facilitate faster statistic correlation through rapid acquisition. The oscilloscopes also offer high offsets of  $\pm 5$  V at the highest sensitivity, making them suitable for basic power integrity measurements even with 10x passive probes.



## Power rail characterization with high fidelity probes

The R&S®RT-ZPR probe is an excellent for accurate power rail characterization with high bandwidth, sensitivity, low noise and large offset compensation capabilities. A bandwidth of up to 2 GHz, sensitive down to a 1:1 attenuation ratio and low noise performance make the R&S®RT-ZPR probe ideal for precise ripple measurements. Combined with the probe's advanced frequency analysis capabilities, periodic and random disturbances (PARD) are effectively isolated. Furthermore, the probe has a high-precision, 18-bit DC voltmeter (R&S®ProbeMeter) for instant DC voltage readout, enhancing measurement accuracy.



## Characterizing power transistor switching behavior

Newer technologies in fast power MOSFET, IGBT and wide bandgap (WBG) devices require a closer look at transistor switching behavior to improve overall system efficiency with better timing control. The digital trigger in the MXO series enables precise triggering with hysteresis control that helps prevent false event detection. The ABR sequential trigger with 0 delay timing available between events also enables complex trigger setups that would not be possible without the digital trigger architecture. The 18-bit HD mode and the zone trigger give the MXO excellent event detection even in noisy environments.



## Safety with isolation and high CMRR measurements

The R&S®RT-ZISO isolated probing system is designed for measurement challenges in high voltage and fast switching environments. The power-over-fiber architecture galvanically isolates the device under test (DUT) from the measurement setup for the highest common mode rejection ratio (CMRR) up to 1 GHz. The probe works seamlessly with the MXO series and is useful when characterizing high-side gate switching, where fast and high voltage transitions in the source node generate fast common signals. The probe can also be applied to high bandwidth current sensing over a series shunt resistor.





# POWER ANALYSIS MADE EASY

## Characterizing input power quality

Measuring AC circuit power quality can be tedious due to the numerous calculations required to determine the real, apparent and reactive power. An oscilloscope is ideal for this work because it provides a clear view of the waveform characteristics between voltage and current, allowing engineers to quickly identify and resolve problems. The R&S®MXO5-K31 enables power quality measurements and provides concurrent analysis of three pairs of voltage and current sources.



## Harmonic current analysis in line with standards

Different standards for limiting the harmonic current must be met in AC power supplies. Identifying distortion from harmonic content is tedious without a proper tool. The R&S®MXO5-K31 includes current harmonic analysis to help test in line with all common standards. You can setup three concurrent harmonic measurements.

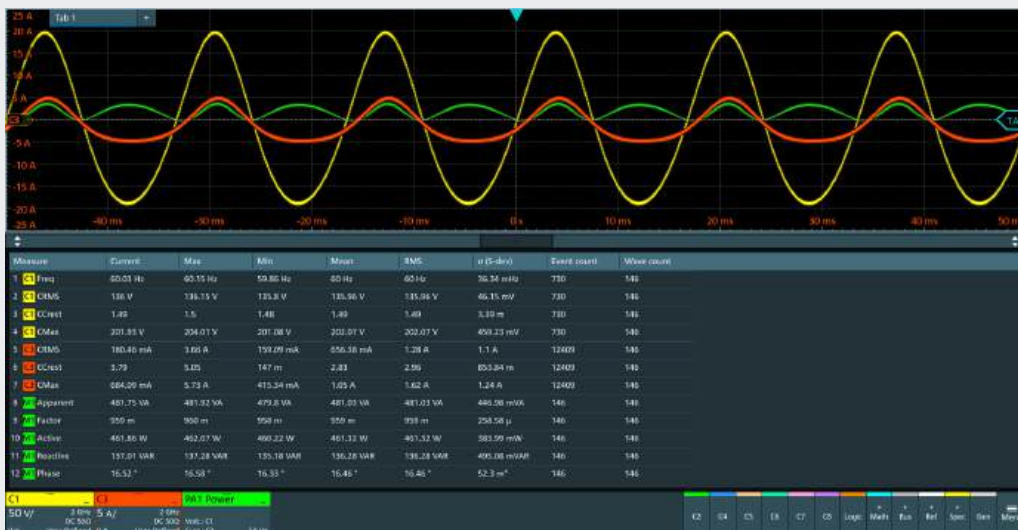

### R&S®MXO5-K31 power analysis option

Power quality	active, apparent and reactive power, crest factor and phase angle
Current harmonics	THD RMS and fundamental functions, in line with EN6100-3-2 classes A, B, C, D, MIL-STD-1399 and RTCA DO-160
More analysis functions will be added in future.	

# STREAMLINE YOUR EMI DEBUGGING

## Effortless navigation in the frequency domain

Enjoy the familiar interface of a spectrum analyzer. The spectrum setup dialog provides basic controls such as start and stop frequency and resolution bandwidth, resembling those of a traditional spectrum analyzer. In spectrum mode, the time domain settings of the MXO 5 remain unaffected, ensuring easy navigation in the frequency domain. The maximum FFT capture bandwidth corresponds to the MXO 5 series bandwidth for a quick overview of all emissions from DC to 2 GHz.

## Correlated time-frequency analysis with gated spectrum

With the gated spectrum function, restrict the spectrum analysis to a user-defined region of the captured time-domain signal. Excessive spectral emissions can be correlated to dedicated time periods in a signal. Typical applications include the correlation of unwanted emissions to fast switching edges in switched-mode power supplies or to data transfers on bus interfaces.

## Ultra-fast spectrum acquisitions for spurious events

The spectrum analysis is equipped with max. hold, min. hold and average spectrum arithmetic to keep track of spectrum events that occur during the testing. These are important test receivers' functions and now come standard on the MXO 5 series.

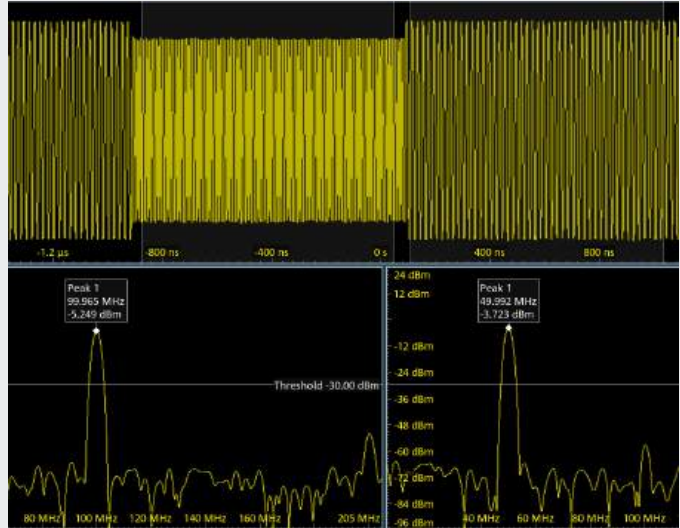

## Perfect setup for EMI detection

Use the compact R&S®HZ-15 near-field probe set, designed specifically for EMI debugging of embedded designs. This probe set includes the most compact probe, which enables the capturing of near-field emissions from individual circuit lines. The R&S®HZ-15 covers the frequency range from 30 MHz to 3 GHz, with the ability to be used below 30 MHz, albeit with reduced sensitivity. The optional R&S®HZ-16 preamplifier offers a gain of 20 dB in the frequency range from 100 kHz to 3 GHz, providing higher sensitivity when needed.

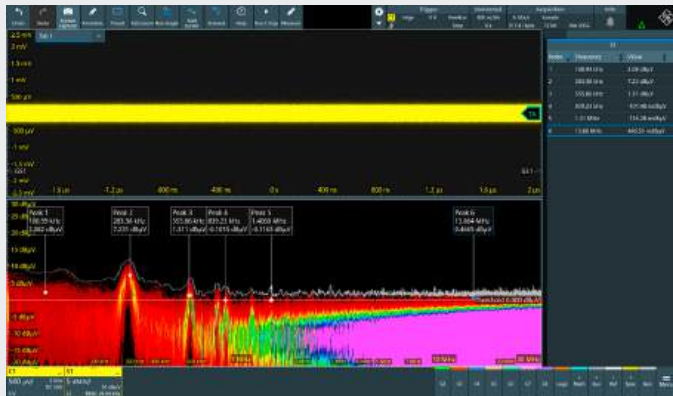

# LOGIC ANALYSIS

## Built-in logic analysis

Every MXO 5 series oscilloscope comes equipped with MSO logic analysis capability. Just add MSO probes to get 16 digital channels. Use the MSO probes across different MXO 4 or MXO 5 oscilloscopes without the need for a software license.



## See precise timing relationships

The oscilloscope logic channels run at 5 Gsample/s, delivering a high time resolution of 200 ps. With a substantial memory depth of 500 Mpoints per channel, this sampling rate remains consistent over a large range of time base settings. Use logic triggering to isolate critical events like narrow glitches and specific pattern combinations

## Analyze low-speed serial buses

In modern devices, high-speed interfaces often coexist with low-speed control or programming buses. Digital channels, available with the R&S®MXO5-B1 option, are tailored for precisely analyzing low-speed serial protocols such as SPI and I<sup>2</sup>C. Use analog or logic channels as sources for protocol trigger and decode with the serial bus options. By focusing on protocol details like start, address and data, gain deep insights into serial bus events. From built-in logic analysis to high-resolution signal capture and low-speed serial bus analysis.



# ANALYZE SERIAL BUSES WITH PROTOCOL INNOVATION

## Dual-path protocol analysis

Experience a breakthrough in protocol analysis with the MXO 5 series. Unlike conventional oscilloscopes, our dual-path protocol analysis revolutionizes the acquisition and decoding of protocol packets. Dual-path protocol analysis decouples instrument sample rates for the waveform path and automatically uses the required sample rate for the decoding path. Even with very slow sample rates or under-sampled waveforms, the protocol data is correctly decoded for decoding on alias waveforms and even longer capture times.

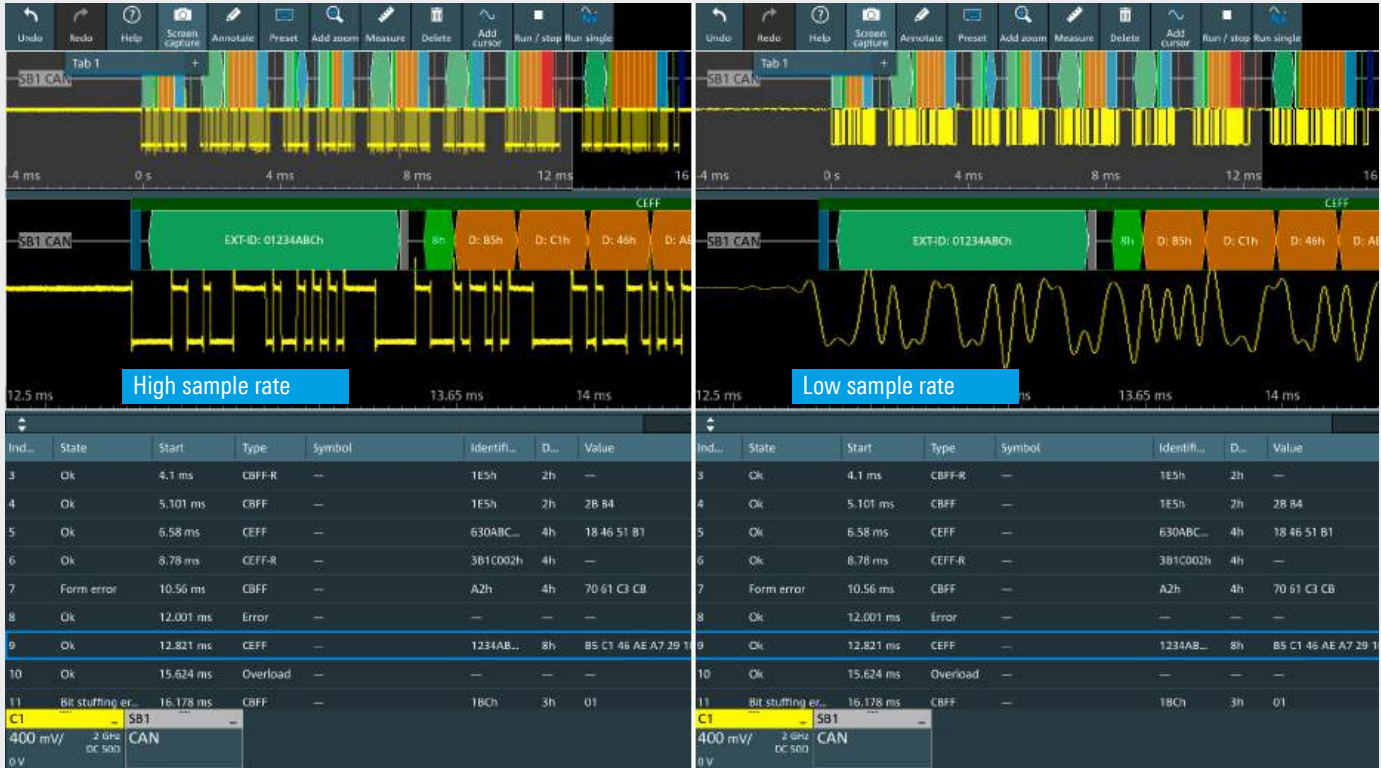

## Capture more data packets with deep memory

Our deep memory can capture more packets. A memory depth of up to 1 Gpoints lets the MXO 5 series capture extended time periods where cause and effect may be some distance apart. Every signal detail remains time-correlated with packet content for fast and efficient debugging.

Ind...	State	Start	Type	Symbol	Identifi...	D...	Value	Nominal bit rate	Data bit rate
3	Ok	4.1 ms	CBFF-R	EngineStatus	1E5h	2h	—	58.5 kbps	58.5 kbps
4	Ok	5.101 ms	CBFF	EngineStatus	1E5h	2h	28 84	55.7 kbps	55.7 kbps
5	Ok	6.58 ms	CEFF	NM_Gateway_PowerTrain	630ABC...	4h	18 46 51 B1	52.7 kbps	52.7 kbps
6	Ok	8.78 ms	CEFF-R	Ignition_Info	3B1C002h	4h	—	53.4 kbps	53.4 kbps
7	Form error	10.56 ms	CBFF	DiagResponse_Motor	A2h	4h	70 61 C3 CB	48.5 kbps	48.5 kbps
8	Ok	12.001 ms	Error	—	—	—	—	—	—
9	Ok	12.821 ms	CEFF	EngineData	1234AB...	8h	85 C1 46 AE A7 29 1E 7F	51.0 kbps	51.0 kbps
10	Ok	15.624 ms	Overload	—	—	—	—	—	—
11	Bit stuffing er...	16.178 ms	CBFF	DiagRequest_Motor	1BCh	3h	01	48.0 kbps	48.0 kbps

Field	Value	Label	Value
CRC	25270	EngSpeed	49589.000 r...
		IdleRunni...	Running
		EngTemp	90.000 degC
		EngForce	42926.000 N
		PetrolLevel	174.000 l
		Undefined	A7h
		EngPower	77.210 kW
		Undefined	7Fh

## Customized display

Condense or expand the decoded layer with the vertical and horizontal control knobs or the intuitive touchscreen. Overlay the decoded bus on the captured signal and/or display it in a separate window for greater flexibility.

Unleash the power of protocol analysis innovation with MXO 5 series oscilloscopes. Experience dual-path protocol analysis, capture more packets with deep memory, and customize your display to enhance your analysis workflow. Stay ahead of the curve and optimize your serial bus analysis capabilities today.

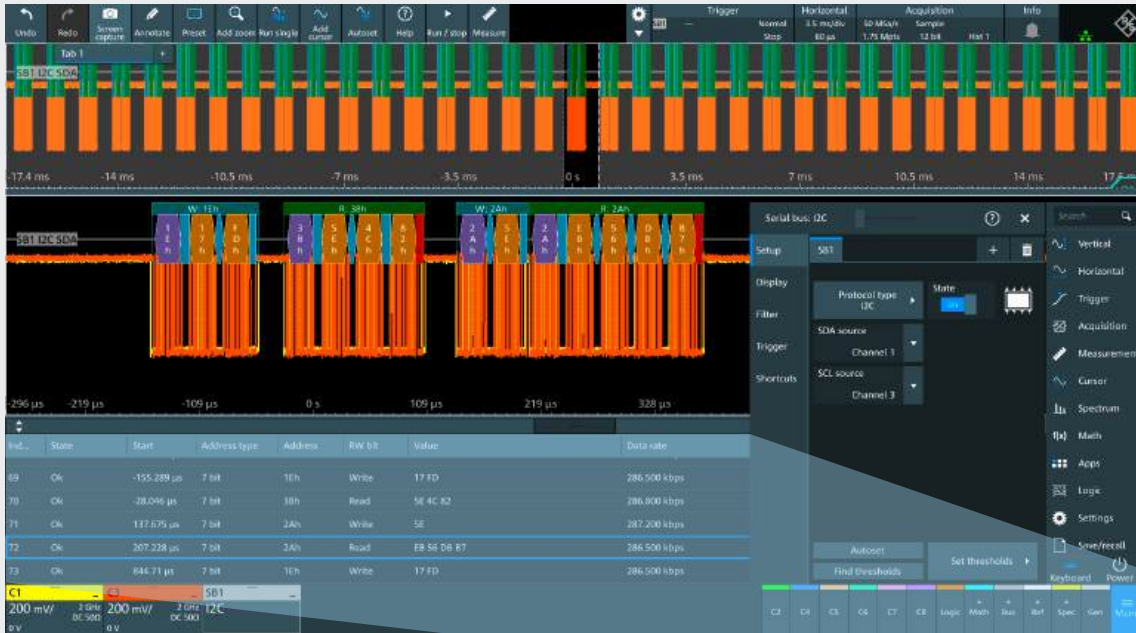

Ind.	State	Start	Address type	Address	RW bit	Value	Data rate
61	Ok	-2.155 ms	7 bit	1Eh	Write	17 FD	286.500 kbps
62	Ok	-2.028 ms	7 bit	38h	Read	5E 4C 82	286.800 kbps
63	Ok	-1.862 ms	7 bit	2Ah	Write	5E	287.200 kbps
64	Ok	-1.793 ms	7 bit	2Ah	Read	EB 56 DB E7	286.500 kbps
65	Ok	-1.155 ms	7 bit	1Eh	Write	17 FD	286.500 kbps
66	Ok	-1.028 ms	7 bit	38h	Read	5E 4C 82	286.800 kbps
67	Ok	862.326 µs	7 bit	2Ah	Write	5E	287.200 kbps
68	Ok	-792.772 µs	7 bit	2Ah	Read	EB 56 DB E7	286.500 kbps
69	Ok	-155.289 µs	7 bit	1Eh	Write	17 FD	286.500 kbps
70	Ok	-28.046 µs	7 bit	38h	Read	5E 4C 82	286.800 kbps
71	Ok	137.675 µs	7 bit	2Ah	Write	5E	287.200 kbps
72	Ok	207.228 µs	7 bit	2Ah	Read	EB 56 DB E7	286.500 kbps
73	Ok	844.71 µs	7 bit	1Eh	Write	17 FD	286.500 kbps
74	Ok	971.953 µs	7 bit	38h	Read	5E 4C 82	286.800 kbps
75	Ok	1.138 ms	7 bit	2Ah	Write	5E	287.200 kbps

Ind.	Value	Ack start	Ack bit
1	EBh	268.271 µs	Ack
2	56h	301.195 µs	Ack
3	DBh	334.149 µs	Ack
4	87h	367.148 µs	Nack

## Trigger and decode packages

Option	Description	Buses
R&S®MXO5-K510	low speed serial buses	I²C/SPI/RS-232/RS-422/RS-485/JART/QUAD-SPI
R&S®MXO5-K520	automotive buses	CAN/CAN FD/CAN XL/LIN/SENT
R&S®MXO4-K530	aerospace protocols	ARINC 429/MIL-STD-1553
R&S®MXO5-K550	MIPI low speed protocols	SPMI/REFE
R&S®MXO5-K560	automotive Ethernet buses	10BASE-T1S/100BASE-T1

# AUTOMATED COMPLIANCE TESTS

## Easy configuration and automatic control with R&S®ScopeSuite+

R&S®ScopeSuite+ is a generic compliance test software that runs on a separate PC. It controls the measurement settings and test sequences on the MXO 5 series oscilloscope and guides you through all the selected tests. Detailed, image based instructions make it easy to correctly connect oscilloscope, probes, test fixtures and DUT. User data, the test setup settings and measurement report definitions are easy to configure. The limit editor lets you individually adjust test limits.

## Flexible test execution

Single tests or a sequence of tests can be repeated as often as required for debugging during development or stability verification. Limit lines and other parameters can be adjusted for each test repetition. Pre-checks on the test waveforms are performed before analysis to further reduce human error and ensure the right signals are captured.

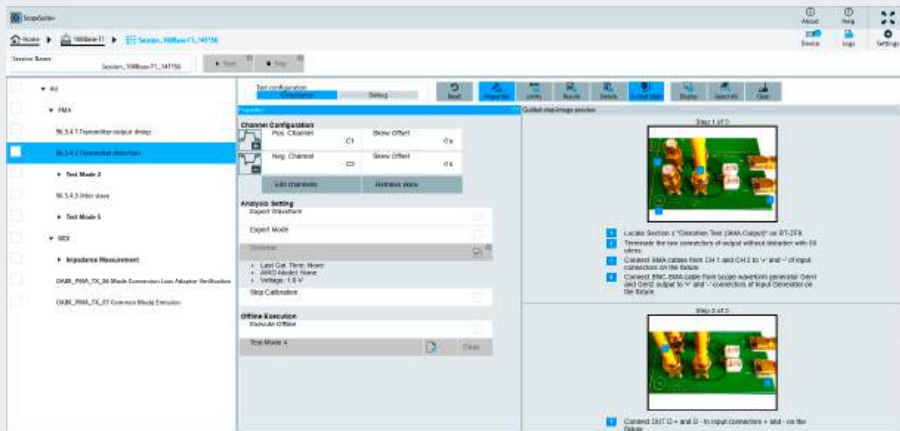

## Configurable reports for result documentation

Documenting the measurement results is essential to compliance tests. R&S®ScopeSuite+ offers an extensive range of documentation functions. You can add measurement details and screenshots to the pass/fail results. The reports are available as PDFs.

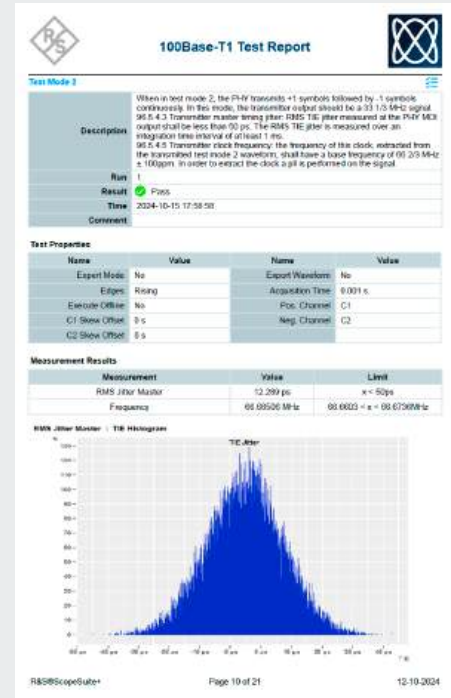

## Test fixture sets from Rohde & Schwarz

Rohde & Schwarz offers test fixture sets in line with the different interface standards to connect the measuring equipment and the DUT.

Compliance test option	Included standard
R&S®SPLUS	base software for compliance testing
R&S®SPLUS-K24	100BASE-T1 automotive Ethernet

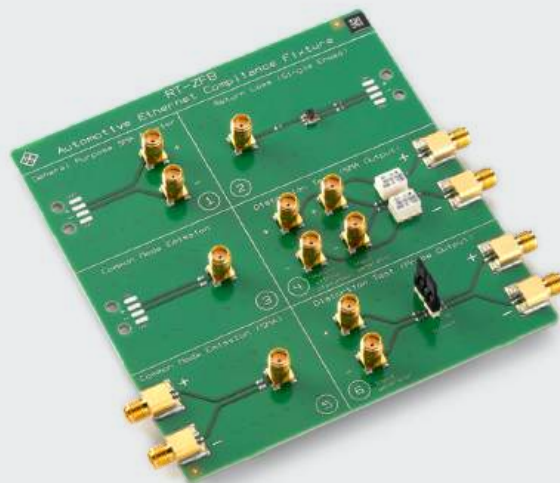

# VERSATILE INTEGRATED ARBITRARY WAVEFORM GENERATOR

## Integrated two-channel waveform generator

Get fully the integrated two-channel 100 MHz arbitrary waveform generator with the R&S®MXO5-B6 option. This compact and configurable solution offers exceptional versatility for various applications, from hardware prototyping to classroom usage. With a sampling rate of 625 Msample/s and 16-bit resolution, the generator delivers reliable performance and precise control as a function or modulation generator.

## Wide range of waveforms and modulation types

Stimulate your device under test with a diverse range of waveforms. Choose from sine, square/pulse, ramp, triangle, sine cardinal (sinc), arbitrary and noise waveforms. Easily customize the frequency, amplitude, offset and noise parameters for each waveform, tailoring the stimulus to your specific needs. Get integrated arbitrary waveform generation capabilities. Take advantage of the modulation feature to explore advanced signal variations.



R&S®MXO5-B6 arbitrary waveform generator option	
Analog output	2 channels
Bandwidth	1 mHz to 100 MHz
Amplitude	high impedance: 20 mV to 10 V (peak-to-peak), 50 Ω: 10 mV to 5 V (peak-to-peak)
Arbitrary waveform length	1 sample to 312.5 Msample
Sample rate	625 Msample/s
Vertical resolution	16 bit
Operating modes	<ul style="list-style-type: none"> <li>▶ function and arbitrary waveform generator (DC, sine, square/pulse, triangle, ramp, inverse ramp, sinc, arbitrary)</li> <li>▶ modulation (AM, FM, FSK, PWM)</li> <li>▶ frequency sweep</li> <li>▶ noise</li> </ul>

# FREQUENCY RESPONSE ANALYSIS WITH BODE PLOT

## Low-frequency response analysis made easy

Quickly perform low-frequency response analysis with the R&S®MXO5-K36 frequency response analysis (FRA) option. Easily characterize the frequency response of various electronic devices, including passive filters and amplifier circuits. Precisely measure the control loop response (CLR) and power supply rejection ratio (PSRR) in switch mode power supplies.

The FRA option leverages the oscilloscope's built-in waveform generator to create stimulus signals from 10 mHz to 100 MHz. By measuring the stimulus signal to output signal ratio for the device under test at each test frequency, the oscilloscope accurately plots logarithmic gain and phase for valuable insights into your device's behavior.

## Enhanced features and functionality

### Amplitude profile for improved SNR

The R&S®MXO5-K36 has user-configurable profiles of the amplitude output level from the generator. This feature optimizes the signal-to-noise ratio (SNR) at different frequency ranges, ensuring high-quality CLR and PSRR measurements.

### Improved resolution and markers support

Adjust resolution and sweep time to your specific requirements with user-configurable points per decade. Markers on the traces conveniently correlate with table entries, making it easy to determine phase and gain margin with the auto placement function.

### Parallel display of time domain

Gain deeper insights by monitoring the time domain alongside the frequency domain. Identify distortion and errors in measurements caused by the injected signal, which may be difficult to detect with just the Bode plot.



### Measurement result table

Quickly access comprehensive information about each measured point, including frequency, gain and phase shift with the measurement result table. Save screenshots, table results, or both to a USB device for reporting and efficient documentation.

### Calibration and setup

FRA has a calibration capability to help optimize measurement setups for greater accuracy when passive probes are used. The calibration data can be saved for future setup for repetitive measurements.

## Broad probe portfolio for accurate characterization

Choose the right probes for accurate CLR and PSRR characterization. The low-noise R&S®RT-ZP1X 38 MHz bandwidth 1:1 passive probe is recommended for the MXO 5 series oscilloscope. The probe minimizes attenuation errors and delivers the best SNR, even at low peak-to-peak amplitudes of  $V_{in}$  and  $V_{out}$ .

### R&S®MXO5-K36 frequency response analysis option

Note: R&S®MXO5-B6 is a prerequisite for FRA applications.

Frequency range	10 mHz to 100 MHz
Amplitude mode	fixed or amplitude profile
Amplitude level	10 mV to 10 V into high Z; 5 mV to 5 V into 50 $\Omega$
Test points	10 points to 500 points per decade



# R&S®ScopeStudio SOFTWARE

## Oscilloscope application software for PCs: Enhance your oscilloscope experience

### An MXO series oscilloscope for your PC

Take your oscilloscope analysis to the next level with R&S®ScopeStudio software. The powerful tool lets you view, analyze, document and share measurements on a PC – when you are away from your oscilloscope. The intuitive MXO series graphical user interface helps efficiently create professional documentation with the flexible R&S®SmartGrid layout, a wide variety of built-in annotation capabilities and a customizable toolbar.

### Acquire once, replay forever

Ever wish to easily access captured oscilloscope waveforms and measurement data when you were away from the instrument? Now you can. Take time for analysis, far from noisy labs and free up the oscilloscope for others. Explore the vast set of MXO series oscilloscope measurement and analysis capabilities, add documentation notes or save information to your local PC or network drive. You can do all this while still acquiring new measurements remotely, thanks to the MXO web interface.

### Easy to view, analyze and measure

R&S®ScopeStudio has the same comprehensive measurement and analysis as MXO series oscilloscopes. You can apply identical measurements and analysis to captured waveforms. You can also seamlessly continue your work on a PC by loading saved sessions, instrument settings and waveforms.

### Quickly share and document

Ever need to remotely collaborate within your company or with external partners, suppliers or customers? Since R&S®ScopeStudio runs on your PC, collaboration is easy with file sharing and PC tools.

### Oscilloscope application software for PCs

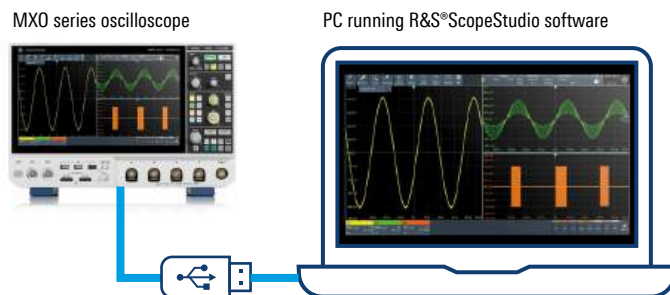

### Key facts

- ▶ PC based analysis of oscilloscope waveforms
- ▶ Advanced signal processing and visualization capabilities
- ▶ Customizable R&S®SmartGrid layout for efficient analysis
- ▶ Seamless integration and compatibility with MXO series oscilloscopes

# EXTENSIVE PROBE PORTFOLIO

## THE RIGHT PROBE FOR THE YOUR MEASUREMENT

MXO 5 oscilloscope comes standard with one 700 MHz passive probe for each channel. Choose from a comprehensive portfolio of high-quality passive and active probes from Rohde & Schwarz for other probe needs



### Complete portfolio for power measurements

The portfolio of dedicated probes for power measurements includes active and passive probes for the different voltage and current ranges – from  $\mu\text{A}$  to  $\text{kA}$  and from  $\mu\text{V}$  to  $\text{kV}$ . Dedicated power rail probes detect even small and sporadic distortions on DC power rails. High voltage differential probes allow isolated floating measurements.

### High-voltage differential probes

The R&S®RT-ZHD series high voltage differential probes provide excellent common mode rejection ratio (CMRR) for a broad frequency with 200 MHz bandwidth and can safely measure up to 6000 V peak voltage. Low noise makes it an ideal probe for switching power analysis with ground reference.

### R&S®ProbeMeter and micro button for easy control

Our active probes feature a micro button, cleverly located on the probe tip, assign various functions to the micro button, such as run/stop, autoset, and adjust offset, enabling direct control of the oscilloscope right from the probe itself.

Most Rohde & Schwarz active probes come with the R&S®ProbeMeter to take precision to a whole new level. The probes impressive accuracy of 0.1 % ensures reliable and trustworthy measurements. When Rohde & Schwarz designs a probe, thermal drifts, filters and usability are usually the best overall. Make measurements a breeze and get precise results with confidence.



## Rohde & Schwarz has a comprehensive probe portfolio to meet every probing need.

► For more information, see product brochure "Probes and accessories for Rohde & Schwarz oscilloscopes" (PD 3606.8866.12)



### Passive probes included as standard (38 MHz to 700 MHz)

R&S°RT-ZP11, R&S°RT-ZP1X

Passive probes come standard with every Rohde & Schwarz oscilloscope. They are low cost, general purpose probes for a broad range of applications.



### Passive broadband probes (8 GHz)

R&S°RT-ZZ80

These are an economical yet powerful alternative to active probes for measuring high speed signals on low impedance lines. They feature extremely low input capacitance, very low noise and high linearity.



### Active single-ended broadband probes (1 GHz to 6 GHz)

R&S°RT-ZS10E, R&S°RT-ZS10, R&S°RT-ZS20,  
R&S°RT-ZS30, R&S°RT-ZS60

A very high dynamic range and exceptionally low offset and gain errors combined with the right accessories make these probes ideal for Rohde & Schwarz oscilloscopes.



### Active differential broadband probes (1 GHz to 4.5 GHz)

R&S°RT-ZD10, R&S°RT-ZD20, R&S°RT-ZD30,  
R&S°RT-ZD40 and R&S°RT-ZA15 external  
attenuator

A flat frequency response and high input impedance with low input capacitance permit precise measurements on differential signals while maintaining a low load on the DUT. The CMMR for the entire probe bandwidth has high interference immunity.

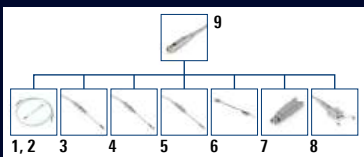

### Modular broadband probes (1.5 GHz to 16 GHz)

R&S°RT-ZM15, R&S°RT-ZM30,  
R&S°RT-ZM60, R&S°RT-ZM90,  
R&S°RT-ZM130,  
R&S°RT-ZM160

Current probing requirements need a technically sophisticated, yet easy-to-handle solution. The various probing solutions meet the demands for high probe bandwidths and dynamic range along with the need for low capacitive load.

1 R&S°RT-ZMA50; 2 R&S°RT-ZMA11; 3 R&S°RT-ZMA10; 4 R&S°RT-ZMA12;  
5 R&S°RT-ZMA15; 6 R&S°RT-ZMA14; 7 R&S°RT-ZMA30; 8 R&S°RT-ZMA40;  
9 R&S°RT-ZM



### Power rail probes (2 GHz and 4 GHz)

R&S°RT-ZPR20, R&S°RT-ZPR40

Wide bandwidth, high sensitivity, very low noise and extra-large DC offset make these probes an excellent tool for characterizing power rails. The integrated high-precision DC voltmeter (R&S°ProbeMeter) provides instantaneous DC voltage readout.



### High voltage probes (100 MHz to 400 MHz; ±750 V to ±6000 V)

R&S°RT-ZH03, R&S°RT-ZH10, R&S°RT-ZH11,  
R&S°RT-ZD01, R&S°RT-ZHD07, R&S°RT-ZHD15,  
R&S°RT-ZHD16, R&S°RT-ZHD60

The Rohde & Schwarz portfolio of high voltage probes includes passive single-ended and active differential probes for voltages up to 6000 V (peak). Different models allow measurements in up to CAT IV environments. Differential probes provide exceptional common mode rejection over a wide bandwidth.



### Current probes (20 kHz to 120 MHz; ±1 mA to ±2000 A)

R&S°RT-ZC02, R&S°RT-ZC03, R&S°RT-ZC05B,  
R&S°RT-ZC10, R&S°RT-ZC10B, R&S°RT-ZC15B,  
R&S°RT-ZC20, R&S°RT-ZC20B, R&S°RT-ZC30,  
R&S°RT-ZC31

Rohde & Schwarz current probes enable accurate, non-intrusive measurements of DC and AC currents. Different models are available to measure currents in the range from 1 mA to 2000 A with a bandwidth of up to 120 MHz. Current probes are available with the Rohde & Schwarz probe interface or a BNC connector for an external power supply.



### EMC near-field probes (30 MHz to 3 GHz)

R&S°HZ-15, R&S°HZ-17

Powerful E and H near-field probes for the frequency range from 30 MHz to 3 GHz with an optional preamplifier expand the application range of the MXO 5 series oscilloscope to include EMI debugging.

# AND THERE IS SO MUCH MORE ...

## AN OSCILLOSCOPE THAT EVOLVES FOR YOUR NEEDS

### Grows with your needs: easy software based upgrades

The MXO 5 series adapts as your needs evolve. Simply install the necessary software licenses, bandwidth upgrade, triggering and decoding of serial protocols, memory expansion or the frequency response analysis option. The waveform generator is built-in, just activate it with a software license. The MSO logic analysis just requires activation of the logic probes. The bandwidth can be upgraded to 2 GHz with a software license for very easy retrofits.

### Regular firmware updates

Regular firmware updates add new functionality to the MXO 5 series oscilloscopes. Download the latest firmware version at [www.rohde-schwarz.com](http://www.rohde-schwarz.com). Use a USB storage device or LAN connection for installation.

### Safe transport and easy rack mounting

An extensive selection of storage and transportation accessories means the MXO 5 series oscilloscopes are always fully protected and easy to transport. The rackmount kit allows easy installation of the oscilloscope in integrated environments.

Accessories	
Front cover	R&S®MXO5-Z1
Soft case	R&S®MXO5-Z3
Transit case, with trolley function	R&S®MXO5-Z4
VESA mounting interface	R&S®MXO5-Z7
19" rackmount kit	R&S®ZZA-MXO5

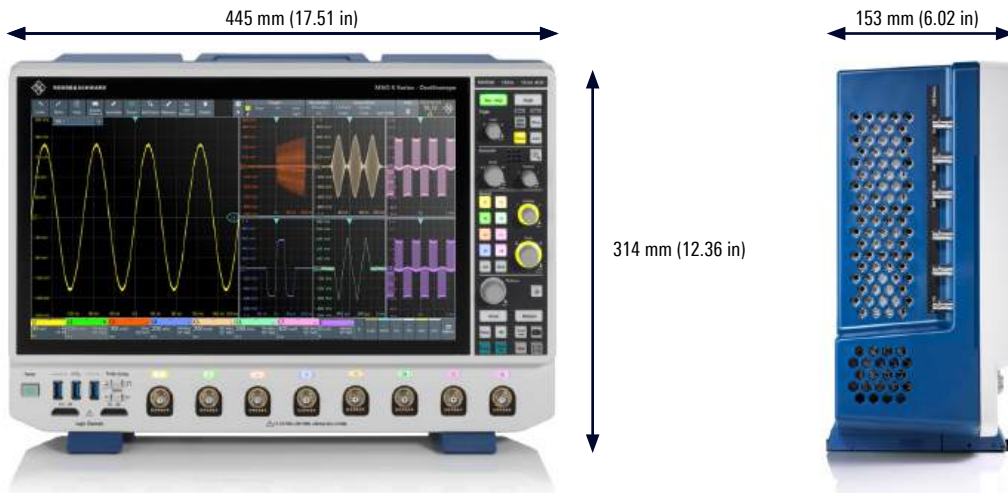

# THE MXO SERIES



... See the big picture  
with all the small details ...

# OSCILLOSCOPE PORTFOLIO



	R&S®RTH1000	R&S®RTC1000	R&S®RTB 2	R&S®RTM3000
<b>Vertical system</b>				
Bandwidth <sup>1)</sup>	60/100/200/350/500 MHz	50/70/100/200/300 MHz	70/100/200/300 MHz	100/200/350/500 MHz/1 GHz
Number of channels	2 plus DMM/4	2	2/4	2/4
Vertical resolution; system architecture	10 bit; 16 bit	8 bit; 16 bit	10 bit; 16 bit	10 bit; 16 bit
V/div, 1 MΩ	2 mV to 100 V	1 mV to 10 V	1 mV to 5 V	500 μV to 10 V
V/div, 50 Ω	–			500 μV to 1 V
Digital channels	8	8	16	16
<b>Horizontal system</b>				
Sampling rate per channel (in Gsample/s)	1.25 (4-channel model); 2.5 (2-channel model); 5 (all channels interleaved)	1; 2 (2 channels interleaved)	1.25; 2.5 (2 channels interleaved)	2.5; 5 (2 channels interleaved)
Maximum memory (per channel; 1 channel active)	125 kpoints (4-channel model); 250 kpoints (2-channel model); 500 kpoints	1 Mpoints; 2 Mpoints	10 Mpoints; 20 Mpoints	40 Mpoints; 80 Mpoints
Segmented memory	standard, 50 Mpoints	–	standard, 260 Mpoints	option, 400 Mpoints
Acquisition rate (in waveforms/s)	50 000	10 000	50 000 (300 000 in fast segmented memory mode)	64 000 (2 000 000 in fast segmented memory mode <sup>2)</sup> )
<b>Trigger</b>				
Types	digital	analog	analog	analog
Sensitivity	–	–	at 1 mV/div: > 2 div	at 1 mV/div: > 2 div
<b>Analysis</b>				
Mask test	tolerance mask	tolerance mask	tolerance mask	tolerance mask
Mathematics	elementary	elementary	basic (math on math)	basic (math on math)
Serial protocols triggering and decoding <sup>1)</sup>	I <sup>2</sup> C, SPI, UART/RS-232/RS-422/RS-485, CAN, LIN, CAN FD, SENT	I <sup>2</sup> C, SPI, UART/RS-232/RS-422/RS-485, CAN, LIN	I <sup>2</sup> C, SPI, UART/RS-232/RS-422/RS-485, CAN, LIN	I <sup>2</sup> C, SPI, UART/RS-232/RS-422/RS-485, CAN, LIN, I <sup>2</sup> S, MIL-STD-1553, ARINC429
Applications <sup>1), 2)</sup>	high-resolution frequency counter, advanced spectrum analysis, harmonics analysis, user scripting	digital voltmeter (DVM), component tester, fast Fourier transform (FFT)	digital voltmeter (DVM), fast Fourier transform (FFT), frequency response analysis	power, digital voltmeter (DVM), spectrum analysis and spectrogram, frequency response analysis
Compliance testing <sup>1), 2)</sup>	–	–	–	–
<b>Display and operation</b>				
Size and resolution	7" touchscreen, 800 × 480 pixel	6.5", 640 × 480 pixel	10.1" touchscreen, 1280 × 800 pixel	10.1" touchscreen, 1280 × 800 pixel
<b>General data</b>				
Dimensions in mm (W × H × D)	201 × 293 × 74	285 × 175 × 140	390 × 220 × 152	390 × 220 × 152
Weight in kg	2.4	1.7	2.5	3.3
Battery	lithium-ion, > 4 h	–	–	–

<sup>1)</sup> Upgradeable.

<sup>2)</sup> Requires an option.



MXO 4	MXO 5/MXO 5C	R&S®RT06	R&S®RTP
200/350/500 MHz/1/1.5 GHz	100/200/350/500 MHz/1/2 GHz	600 MHz/1/2/3/4/6 GHz	4/6/8/13/16 GHz
4	4/8	4	4
12 bit; 18 bit	12 bit; 18 bit	8 bit; 16 bit	8 bit; 16 bit
500 µV to 10 V	500 µV to 10 V	1 mV to 10 V (HD mode: 500 µV to 10 V)	
500 µV to 1 V	500 µV to 1 V	1 mV to 1 V (HD mode: 500 µV to 1 V)	2 mV to 1 V (HD mode: 1 mV to 1 V)
16	16	16	16
2.5; 5 (2 channels interleaved)	5 on 4 channels; 2.5 on 8 channels (2 channels interleaved)	10; 20 (2 channels interleaved in 4 GHz and 6 GHz model)	20; 40 (2 channels interleaved)
standard: 400 Mpoints; max. upgrade: 800 Mpoints <sup>2)</sup>	standard: 500 Mpoints max. upgrade: 1 Gpoints <sup>2)</sup>	standard: 200 Mpoints/800 Mpoints; max. upgrade: 1 Gpoints/2 Gpoints	standard: 100 Mpoints/400 Mpoints; max. upgrade: 3 Gpoints
standard: 10000 segments; option: 1000000 segments	standard: 10000 segments; option: 1000000 segments	standard	standard
> 4500000	> 4500000 on 4 channels	1000000 (2500000 in ultra-segmented memory mode)	750000 (> 3000000 in ultra-segmented memory mode)
advanced (includes zone trigger), digital trigger (15 trigger types)	advanced (includes zone trigger), digital trigger (15 trigger types)	advanced (includes zone trigger), digital trigger (15 trigger types), high speed serial pattern trigger including 5 Gbps clock data recovery (CDR) <sup>2)</sup>	advanced (includes zone trigger), digital trigger (14 trigger types) with real-time deembedding <sup>2)</sup> , high speed serial pattern trigger including 8/16 Gbps clock data recovery (CDR) <sup>2)</sup>
0.0001 div, across full bandwidth, user controllable	0.0001 div, across full bandwidth, user controllable	0.0001 div, across full bandwidth, user controllable	0.0001 div, across full bandwidth, user controllable
user configurable, hardware based advanced (formula editor)	user configurable, hardware based advanced (formula editor)	user configurable, hardware based advanced (formula editor, Python interface)	user configurable, hardware based advanced (formula editor, Python interface)
I <sup>2</sup> C, SPI, UART/RS-232/RS-422/RS-485, CAN, CAN FD, CAN XL, LIN, ARINC 429, MIL-STD-1553, SPMI, 10BASE-T1S, QUAD-SPI, SENT, RFFE	I <sup>2</sup> C, SPI, UART/RS-232/RS-422/RS-485, CAN, CAN FD, CAN XL, LIN, ARINC 429, MIL-STD-1553, SPMI, 10BASE-T1S, 100BASE-T1, QUAD-SPI, SENT, RFFE	I <sup>2</sup> C, SPI, UART/RS-232/RS-422/RS-485, CAN, LIN, I <sup>2</sup> S, MIL-STD-1553, ARINC 429, FlexRay, CAN FD, MIPI RFFE, USB 2.0/HSC, MDIO, 8b10b, Ethernet, Manchester, NRZ, SENT, MIPI D-PHY, SpaceWire, MIPI M-PHY/UniPro, CXPI, USB 3.1 Gen 1, USB-SSIC, PCIe 1.1/2.0, USB Power Delivery, Automotive Ethernet 100/1000BASE-T1	I <sup>2</sup> C, SPI, UART/RS-232/RS-422/RS-485, SENT, CAN, LIN, CAN FD, MIL-STD-1553, ARINC 429, SpaceWire, USB 2.0/HSC/PD, USB 3.1 Gen 1/Gen 2/SSIC, PCIe 1.1/2.0/3.0, 8b10b, MIPI RFFE, MIPI D/M-PHY/UniPro, Automotive Ethernet 100/1000BASE-T1, Ethernet 10/100BASE-TX, MDIO, Manchester, NRZ
power, digital voltmeter (DVM), frequency response analysis	power, digital voltmeter (DVM), frequency response analysis	power, advanced spectrum analysis and spectrogram, jitter and noise decomposition, clock data recovery (CDR), I/Q data and RF analysis (R&S®VSE), deembedding, embedding, equalization, PAM-N, TDR/TDT analysis, advanced eye diagram	advanced spectrum analysis and spectrogram, jitter and noise decomposition, real-time deembedding, embedding, equalization, PAM-N, TDR/TDT analysis, I/Q data and RF analysis (R&S®VSE), advanced eye diagram
-		see specifications (PD 5216.1640.22)	see specifications (PD 3683.5616.22)
13.3" touchscreen, 1920 × 1080 pixel (Full HD)	for MXO 5 only: 15.6" touchscreen, 1920 × 1080 pixel (Full HD)	15.6" touchscreen, 1920 × 1080 pixel (Full HD)	13.3" touchscreen, 1920 × 1080 pixel (Full HD)
414 × 279 × 162	MXO 5: 445 × 314 × 154 MXO 5C: 445 × 105 × 405	450 × 315 × 204	441 × 285 × 316
6	MXO 5: 9 MXO 5C: 8.7	10.7	18
-	-	-	-

# SPECIFICATIONS OF BASE UNIT

## Vertical system: analog channels

Input channels	4 channels or 8 channels		
Input impedance	50 $\Omega$ $\pm$ 1.5%, 1 M $\Omega$ $\pm$ 1%    12 pF (meas.)		
Analog bandwidth (-3 dB)	4-channel instrument		
	at 50 $\Omega$ input impedance		
	MXO 54	$\geq$ 350 MHz	
	MXO 54 with -B245 option	$\geq$ 500 MHz	
	MXO 54 with -B2410 option	$\geq$ 1 GHz	
	MXO 54 with -B2420 option	$\geq$ 2 GHz	
	at 1 M $\Omega$ input impedance		
	MXO 54	$\geq$ 350 MHz (meas.)	
	MXO 54 with -B245 option	$\geq$ 500 MHz (meas.)	
	MXO 54 with -B2410 option	$\geq$ 700 MHz (meas.) <sup>1)</sup>	
	MXO 54 with -B2420 option	$\geq$ 700 MHz (meas.) <sup>1)</sup>	
	8-channel instrument		
	at 50 $\Omega$ input impedance		
	MXO 58	$\geq$ 100 MHz	
	MXO 58 with -B282 option	$\geq$ 200 MHz	
	MXO 58 with -B283 option	$\geq$ 350 MHz	
	MXO 58 with -B285 option	$\geq$ 500 MHz	
	MXO 58 with -B2810 option	$\geq$ 1 GHz	
	MXO 58 with -B2820 option	$\geq$ 2 GHz <sup>2)</sup>	
	at 1 M $\Omega$ input impedance		
MXO 58	$\geq$ 100 MHz (meas.)		
MXO 58 with -B282 option	$\geq$ 200 MHz		
MXO 58 with -B283 option	$\geq$ 350 MHz		
MXO 58 with -B285 option	$\geq$ 500 MHz (meas.)		
MXO 58 with -B2810 option	$\geq$ 700 MHz (meas.) <sup>1)</sup>		
MXO 58 with -B2820 option	$\geq$ 700 MHz (meas.) <sup>1)</sup>		
Additional bandwidth filters available up to instrument bandwidth	1 GHz, 500/350/200/100/50/20 MHz (meas.)		
Rise/fall time (calculated)	10% to 90% at 50 $\Omega$		
	4-channel instrument		
	MXO 54	< 1.75 ns	
	MXO 54 with -B245 option	< 700 ps	
	MXO 54 with -B2410 option	< 350 ps	
	MXO 54 with -B2420 option	< 175 ps	
	8-channel instrument		
	MXO 58	< 3.5 ns	
	MXO 58 with -B282 option	< 1.75 ns	
	MXO 58 with -B283 option	< 1 ns	
	MXO 58 with -B285 option	< 700 ps	
	MXO 58 with -B2810 option	< 350 ps	
	MXO 58 with -B2820 option	< 175 ps <sup>2)</sup> (interleaved), < 350 ps (non-interleaved)	
	Effective number of bits (meas.)	at 50 $\Omega$ , 50 mV/div, with HD mode and digital filters, 10 MHz sine signal with 80% full-scale	
		10 MHz	10.0
20 MHz		9.6	
100 MHz		8.7	
200 MHz		8.2	
300 MHz		7.9	
500 MHz		7.6	
1 GHz	7.0		
Vertical resolution	12 bit, 18 bit for high definition (HD) mode		

<sup>1)</sup> With R&S®RT-ZP11 passive probe.

<sup>2)</sup> 2 GHz analog bandwidth in interleave mode with 5 Gsample/s real-time sampling rate.



## Vertical system: analog channels

Input sensitivity	at 50 Ω	0.5 mV/div to 3 V/div, entire analog bandwidth supported for all input sensitivities
	at 1 MΩ	0.5 mV/div to 10 V/div, entire analog bandwidth supported for all input sensitivities
DC gain accuracy	offset and position set to 0 V, after self-alignment	
	input sensitivity > 5 mV/div	±1 % full scale
	input sensitivity ≤ 5 mV/div to ≥ 1 mV/div	±1.5 % full scale
Input coupling	at 50 Ω	DC
	at 1 MΩ	DC, AC (> 7 Hz)
Maximum input voltage	at 50 Ω	5 V (RMS), 30 V (V <sub>p</sub> )
	at 1 MΩ	300 V (RMS), 400 V (V <sub>p</sub> ), derates at 20 dB/decade to 5 V (RMS) above 250 kHz
		at 1 MΩ with R&S®RT-ZP11 passive probe
Position range		±5 div
Offset range at 50 Ω	input sensitivity	
	120 mV/div to 3 V/div	±(15 V – input sensitivity × position)
	33 mV/div to < 120 mV/div	±(7 V – input sensitivity × position)
Offset range at 1 MΩ	0.5 mV/div to < 33 mV/div	±(2 V – input sensitivity × position)
	input sensitivity	
	800 mV/div to 10 V/div	±200 V
Offset accuracy	80 mV/div to < 800 mV/div	±50 V
	0.5 mV/div to < 80 mV/div	±(5 V – input sensitivity × position)
		±(0.35 % ×  net offset  + 0.5 mV + 0.1 div × input sensitivity); (net offset = offset – position × input sensitivity)
DC measurement accuracy	after adequate suppression of measurement noise using high definition (HD) mode or wave-form averaging or a combination of both	±(DC gain accuracy ×  reading – net offset  + offset accuracy)
Channel-to-channel isolation (each channel at same input sensitivity)	input frequency inside instrument bandwidth	> 60 dB (1:1000)

### RMS noise floor<sup>3)</sup>

At 50 Ω (meas.)	Input sensitivity	Analog bandwidth (–3 dB)					
		100 MHz	200 MHz	350 MHz	500 MHz	1 GHz	2 GHz
	0.5 mV/div	19 μV	26 μV	33 μV	39 μV	66 μV	111 μV
	1 mV/div	24 μV	33 μV	42 μV	51 μV	85 μV	141 μV
	2 mV/div	25 μV	35 μV	44 μV	53 μV	89 μV	146 μV
	5 mV/div	34 μV	46 μV	59 μV	71 μV	116 μV	182 μV
	10 mV/div	66 μV	89 μV	115 μV	138 μV	226 μV	350 μV
	20 mV/div	134 μV	181 μV	233 μV	280 μV	461 μV	713 μV
	50 mV/div	324 μV	436 μV	563 μV	677 μV	1.12 mV	1.78 mV
	100 mV/div	610 μV	815 μV	1.05 mV	1.26 mV	2.08 mV	3.25 mV
	200 mV/div	1.26 mV	1.69 mV	2.17 mV	2.60 mV	4.31 mV	6.74 mV
	500 mV/div	4.21 mV	5.54 mV	6.94 mV	8.21 mV	12.93 mV	18.63 mV
	1 V/div	6.88 mV	9.20 mV	11.71 mV	14.02 mV	22.57 mV	32.89 mV
	2 V/div	11.45 mV	15.21 mV	19.45 mV	23.21 mV	37.85 mV	54.59 mV
	3 V/div	15.77 mV	20.78 mV	26.54 mV	31.71 mV	51.80 mV	73.68 mV

<sup>3)</sup> HD mode active for bandwidth ≤ 500 MHz.

## Vertical system: analog channels

At 1 M $\Omega$ (meas.)	Input sensitivity	Analog bandwidth (-3 dB)					
		100 MHz	200 MHz	350 MHz	500 MHz	700 MHz	
	0.5 mV/div	35 $\mu$ V	40 $\mu$ V	46 $\mu$ V	54 $\mu$ V	85 $\mu$ V	
	1 mV/div	36 $\mu$ V	42 $\mu$ V	49 $\mu$ V	57 $\mu$ V	89 $\mu$ V	
	2 mV/div	38 $\mu$ V	45 $\mu$ V	54 $\mu$ V	64 $\mu$ V	101 $\mu$ V	
	5 mV/div	47 $\mu$ V	58 $\mu$ V	77 $\mu$ V	92 $\mu$ V	141 $\mu$ V	
	10 mV/div	68 $\mu$ V	89 $\mu$ V	126 $\mu$ V	152 $\mu$ V	229 $\mu$ V	
	20 mV/div	120 $\mu$ V	161 $\mu$ V	235 $\mu$ V	285 $\mu$ V	428 $\mu$ V	
	50 mV/div	297 $\mu$ V	401 $\mu$ V	592 $\mu$ V	719 $\mu$ V	1.08 mV	
	100 mV/div	678 $\mu$ V	892 $\mu$ V	1.25 mV	1.47 mV	2.16 mV	
	200 mV/div	1.21 mV	1.62 mV	2.33 mV	2.77 mV	4.09 mV	
	500 mV/div	2.88 mV	3.88 mV	5.68 mV	6.76 mV	10.01 mV	
	1 V/div	6.11 mV	8.08 mV	11.54 mV	13.56 mV	18.51 mV	
	2 V/div	11.42 mV	15.20 mV	22.04 mV	25.98 mV	35.39 mV	
	5 V/div	29.10 mV	38.75 mV	56.46 mV	66.60 mV	90.40 mV	
	10 V/div	44.33 mV	58.62 mV	85.77 mV	101.12 mV	137.86 mV	

## Vertical system: digital channels

Input channels		16 logic channels (D0 to D15)
Arrangement of input channels		arranged in two logic probes with 8 channels each, assignment of the logic probes to the channels (D0 to D7 and D8 to D15) is displayed on the probe
Input impedance		100 k $\Omega$ $\pm$ 2%    $\sim$ 4 pF (meas.) at probe tips
Maximum input frequency	signal with minimum input voltage swing and hysteresis setting: normal	400 MHz (meas.)
Maximum input voltage		$\pm$ 40 V ( $V_p$ )
Minimum input voltage swing		500 mV ( $V_{pp}$ ) (meas.)
Threshold groups		D0 to D3, D4 to D7, D8 to D11 and D12 to D15
Threshold level	range	$\pm$ 8 V in 25 mV steps
	predefined	CMOS 5.0 V, CMOS 3.3 V, CMOS 2.5 V, TTL, ECL, PECL, LVPECL
Threshold accuracy	threshold level between $\pm$ 4 V	$\pm$ (100 mV + 3% of threshold setting)
Comparator hysteresis		normal, robust, maximum

## Horizontal system

Timebase range		selectable between 200 ps/div and 10000 s/div, time per div settable to any value within range
Deskew range (channel deskew)	between analog channels	$\pm$ 20 ms
	between digital channels	$\pm$ 100 ns
Reference position		0% to 100% of measurement display area
Horizontal position range (trigger offset range)	max.	+(memory depth/current sampling rate)
	min.	-5000 s
Modes		normal
Channel-to-channel skew	between analog channels	< 100 ps (meas.)
	between digital channels	< 500 ps (meas.)
Timebase accuracy	after delivery/calibration, at +23 $^{\circ}$ C	$\pm$ 0.2 ppm
	during calibration interval	$\pm$ 1 ppm
Delta time accuracy	corresponds to time error between two edges on same acquisition and channel; signal amplitude greater than five divisions, measurement threshold set to 50%, vertical gain 10 mV/div or greater; rise time lower than four sample periods; waveform acquired in real-time mode	$\pm$ (0.20/real-time sampling rate + timebase accuracy $\times$  reading ) (peak) (meas.)

## Acquisition system

Sampling rate	analog channels (real time)	max. 5 Gsample/s on 4 channels, max. 2.5 Gsample/s on 8 channels
	analog channels (interpolated)	max. 5 Tsample/s
	digital channels	max. 5 Gsample/s on each channel
Waveform acquisition rate	max.	> 4500000 waveforms/s
Trigger rearm time	min.	< 21 ns

Acquisition system		
Memory depth <sup>4)</sup>	standard	
	analog channels only	with 8 active channels: ▶ max. 500 Mpoints (single capture) ▶ max. 250 Mpoints (run continuous) with 4 active channels: ▶ max. 500 Mpoints (single capture and run continuous)
	digital channels only (MSO)	with 16 digital channels: ▶ max. 500 Mpoints (single capture) with 8 digital channels: ▶ max. 500 Mpoints (run continuous)
	mix analog and digital	with 2 analog and 8 digital channels: ▶ max. 500 Mpoints (single capture) ▶ max. 250 Mpoints (run continuous)
	with R&S®MXO5-B110 memory option 1 Gpoints	
	analog channels only	with 4 active channels: ▶ max. 1 Gpoints (single capture) with 2 active channels: ▶ max. 1 Gpoints (run continuous)
	digital channels only (MSO)	with 16 digital channels: ▶ max. 500 Mpoints (single capture) ▶ max. 250 Mpoints (run continuous) with 8 digital channels: ▶ max. 1 Gpoints (single capture) ▶ max. 500 Mpoints (run continuous)
	mix analog and digital	with 2 analog and 8 digital channels: ▶ max. 500 Mpoints (single capture) ▶ max. 250 Mpoints (run continuous)
Acquisition modes	sample	middle sample in decimation interval
	peak detect	largest and smallest sample in decimation interval
	average	average value of samples in decimation interval
	number of averaged waveforms	2 to 16777215
	envelope	envelope of acquired waveforms
Sampling modes	real-time mode	max. sampling rate set by digitizer
	interpolated time	enhancement of sampling resolution by interpolation; max. sampling rate is 5 Tsample/s
Interpolation modes		linear, sin(x)/x, sample&hold
Fast segmentation mode	continuous recording of waveforms in acquisition memory without interruption due to visualization	
	max. real-time waveform acquisition rate	> 4600000 waveforms/s
	min. blind time between consecutive acquisitions	< 21 ns

High definition mode		
General description	The high definition mode increases the bit resolution of the waveform signal by using digital filtering, leading to reduced noise. Because of the digital trigger concept of the MXO 5, signals with increased numeric resolution are used as the input for triggering.	
Numeric resolution	bandwidth, at 5 Gsample/s	bit resolution
	1 kHz to 10 MHz	18 bit
	100 MHz	16 bit
	200 MHz	15 bit
	500 MHz	14 bit
Real-time sampling rate	all models	max. 2.5 Gsample/s on 4 channels, max. 1.25 Gsample/s on 8 channels

Trigger system		
Trigger sources		analog channels (C1 to C8), digital channels (D0 to D15), trigger input, line trigger, serial bus
Trigger level range		±5 div from center of screen
Trigger modes		auto, normal, single, n single

<sup>4)</sup> The maximum available memory depth depends on the bit resolution of the acquired data and, therefore, on the acquisition system settings such as decimation mode, use of waveform arithmetics or high definition (HD) mode. Interleave channels of the MXO 58 are on C1 and C5, C2 and C6, C3 and C7 as well as C4 and C8. For the MXO 54, all 4 channels run with 5 Gsample/s and maximum bandwidth.

## Trigger system

Trigger sensitivity		0.0001 div, from DC to instrument bandwidth for all vertical scales, user adjustable
Trigger jitter	full-scale sine wave of frequency set to -3 dB bandwidth	< 1 ps (RMS) (meas.)
Coupling mode	standard	same as selected channel
	HF reject	cutoff frequency selectable from 1 kHz to 500 MHz
	LF reject	attenuates frequencies < 50 kHz
Trigger hysteresis	modes	auto (default setting) or manual
	adjustment resolution	0.0001 div, from DC to instrument bandwidth for all vertical scales
Holdoff range	time	100 ns to 10 s, fixed and random
<b>Main trigger modes</b>		
Edge	triggers on specified edge (positive, negative or either) and level	
Glitch	triggers on glitches of positive, negative or either polarity that are shorter or longer than specified width	
	glitch width	200 ps to 1000 s
Width	triggers on positive or negative pulse of specified width; width can be shorter, longer, inside or outside a specified range	
	pulse width	200 ps to 1000 s
Runt	triggers on pulse of positive, negative or either polarity that crosses one threshold but fails to cross a second threshold before crossing the first one again; runt pulse width can be arbitrary, shorter, longer, inside or outside a specified range	
	runt pulse width	200 ps to 1000 s
Window	triggers when signal enters or exits a specified voltage range; triggers also when signal stays inside or outside the voltage range for a specified period of time	
Timeout	triggers when signal stays high, low or unchanged for a specified period of time	
	timeout	0 ps to 1000 s
Interval	triggers when time between two consecutive edges of same slope (positive or negative) is shorter, longer, inside or outside a specified range	
	interval time	200 ps to 1000 s
Slew rate	triggers when the time required by a signal edge to toggle between user-defined upper and lower voltage levels is shorter, longer, inside or outside a specified range; edge slope may be positive, negative or either	
	toggle time	0 ps to 1000 s
Setup & hold	triggers on setup time and hold time violations between clock and data present on any two input channels; monitored time interval may be specified by the user in the range from -100 s to 100 s around a clock edge and must be at least 200 ps wide	
Pattern	triggers when a logical combination (and, nand, or, nor) of the input channels stays true for a period of time shorter, longer, inside or outside a specified range	
State	triggers when a logical combination (and, nand, or, nor) of the input channels stays true at a slope (positive, negative or either) in one selected channel	
<b>Advanced trigger modes</b>		
Zone trigger	triggers on user-defined zones drawn on the display	
	source	acquired waveforms (input channels), math waveforms (including power analysis waveforms), spectrum waveforms
	number of zones/areas	up to 4 zones with up to 8 areas each
	area shapes	polygons with up to 16 points
	area types	must intersect, must not intersect
	combination of zones	logical combination of zones of multiple sources using Boolean expressions
	trigger compatibility	requires sequence trigger A ▷ zone trigger where primary A condition can be: edge, glitch, width, runt, window, timeout, interval, slew rate, state, pattern
Sequence trigger (A/B/R trigger)	triggers on B event after occurrence of A event; delay condition after A event specified as time interval; an optional R event resets the trigger sequence to A	
	trigger sources	analog channels (C1 to C8)
	A event	edge, glitch, width, runt, window, timeout, interval, slew rate
	B event	edge, glitch, width, runt, window, timeout, interval, slew rate
	R event	edge, glitch, width, runt, window, timeout, interval, slew rate

Trigger system		
Serial bus trigger	optional	see dedicated triggering and decoding options
Trigger input	input impedance	50 Ω (meas.) or 1 MΩ (meas.)    11 pF (meas.)
	max. input voltage at 50 Ω	30 V (V <sub>p</sub> )
	max. input voltage at 1 MΩ	300 V (RMS), 400 V (V <sub>p</sub> ), derates at 20 dB/decade to 5 V (RMS) above 250 kHz
	trigger level	±5 V
	sensitivity	
	input frequency ≤ 500 MHz	300 mV (V <sub>pp</sub> ) (meas.)
	input coupling	AC, DC (50 Ω and 1 MΩ)
	trigger filter	HF reject (attenuates > 50 kHz), LF reject (attenuates < 50 kHz), noise reject
	trigger modes	edge (positive, negative or either)
Trigger output	functionality	A pulse is generated for each event triggering signal acquisition.
	output voltage	0 V to 5 V (nom.) at high impedance; 0 V to 2.5 V (nom.) at 50 Ω
	pulse width	selectable between 16 ns and 50 ms
	pulse polarity	low active or high active
	output delay	depends on trigger settings

Spectrum analysis		
General description	Spectrum analysis allows up to four signal analysis in the frequency domain.	
Spectrum	sources	channel 1 to channel 8
	setup parameters	center frequency, frequency span, resolution bandwidth (automatic or manual), gate position, gate width, vertical scaling, vertical position
	scaling	dBm, dBV, dBμV, V (RMS)
	span	1 Hz to 1.8 GHz <sup>5)</sup>
	resolution bandwidth (RBW)	(span/4) ≥ RBW ≥ (span/6000)
	windows	flat top, Hanning, Hamming, Blackman, rectan- gular, Kaiser Bessel, Gaussian
	trace types	normal, max. hold, min. hold, average
	max. real-time waveform acquisition rate	> 40 000 waveforms/s
Gate	delimits the display region used for spectrum analysis	
Peak list	The values in the peak list are also shown in the diagram to allow easy correlation.	

RF characteristics		
Sensitivity/noise density	at 1 GHz (measurement of the power spectral density at 1 GHz at input sensitivity 2 mV/div, corresponding to –30 dBm input range of the oscilloscope, using spectrum analysis with center frequency 1 GHz, span 500 kHz, RBW 3 kHz)	–160 dBm (1 Hz) (meas.)
Noise figure	at 1 GHz (calculated based on the noise power density above)	14 dB (meas.)
Dynamic range	measured for a 1 GHz input carrier with level –3 dBm at input of oscilloscope, using spec- trum analysis with center frequency 1 GHz, span 2 MHz, RBW 400 Hz at +20 MHz from center frequency	106 dB (meas.)
Absolute amplitude accuracy	0 Hz to 1.2 GHz	±1 dB (meas.)
Spurious-free dynamic range (excluding harmonics)	measured for a 250 MHz input carrier with level –3 dBm at input sensitivity 50 mV/div, using spectrum analysis with center frequency 900 MHz, span 1.8 GHz, RBW 300 kHz	67 dBc (meas.)
Second harmonic distortion	measured for a 250 MHz input carrier with level –3 dBm at input sensitivity 50 mV/div, using spec- trum analysis with center frequency 900 MHz, span 1.8 GHz, RBW 300 kHz	–65 dBc (meas.)

<sup>5)</sup> The stop frequency depends on the analog bandwidth of the instrument.

RF characteristics		
Third harmonic distortion	measured for a 250 MHz input carrier with level -3 dBm at input sensitivity 50 mV/div, using spectrum analysis with center frequency 900 MHz, span 1.8 GHz, RBW 300 kHz	-49 dBc (meas.)

## Waveform measurements

Automatic measurements	measurements on acquired waveforms (input channels), math waveforms, reference waveforms	amplitude, high, low, maximum, minimum, peak-to-peak, mean, RMS, sigma, positive overshoot, negative overshoot, area, rise time, fall time, positive pulse width, negative pulse width, period, frequency, positive duty cycle, negative duty cycle, delay, phase, burst width, pulse count, edge count, pulse train, positive switching, negative switching, cycle area, cycle mean, cycle RMS, cycle sigma, setup, hold, setup/hold time, setup/hold ratio, slew rate rising, slew rate falling, delay to trigger
	gate	delimits the display region evaluated for automatic measurements
	reference levels	user-configurable vertical levels define support structures for automatic measurements
	statistics	displays maximum, minimum, mean, standard deviation and measurement count for each automatic measurement
	number of active measurements	24
Cursor measurements	available cursors	up to four cursor sets on screen, each set with two horizontal and two vertical cursors
	target waveforms	acquired waveforms (input channels), math waveforms, reference waveforms, XY diagrams
	operating modes	vertical measurements, horizontal measurements, or both; vertical cursors either set manually or locked to waveform

## Waveform math

General features	number of math equations	up to 8
	number of reference waveforms	up to 8
	sources	channel 1 to 8, math waveforms 1 to 8, reference waveforms 1 to 8
Functions	operators	add, subtract, multiply, divide, absolute value, square, square root, integrate, differentiate, log, log <sub>e</sub> , log <sub>2</sub> , reciprocal, invert, lowpass, highpass, rescale ( $a \cdot x + b$ )
	filters	lowpass, highpass
	filter types	Gaussian, rectangular
	gate	delimits the display region used for waveform math

## Digital voltmeter

Accuracy		related to channel settings of voltmeter source
Measurements		DC, DC RMS, AC RMS
Sources	MXO 54	C1, C2, C3, C4
	MXO 58	C1, C2, C3, C4, C5, C6, C7, C8
Number of measurements		up to 4
Resolution		up to 6 digits
Bandwidth		up to 20 MHz

## Display characteristics

Diagram types	Yt, XY, zoom, spectrum
Display configuration (waveform layout)	The display area can be split into separate diagram areas by dragging and dropping signal icons. Each diagram can hold any number of signals. Diagrams can be stacked on top of each other and later accessed via dynamic tabs (Tab 1, etc.)
Signal icons	Each active waveform is represented by a signal icon on the signal bar; the signal icon displays the individual vertical and acquisition settings.

Display characteristics	
Toolbar	Enables quick access to important tools; allows to set the most common parameters directly in a simple menu and gives access to more detailed parameters in the main menu. User-defined selection of tools in the toolbar.
Upper menu bar	Displays trigger, horizontal and acquisition system settings; allows quick access to these settings.
Main menu	Provides access to all instrument settings in a compact menu structure.
Axis label	The x-axis and y-axis are labeled with values and physical unit.
Diagram label	Diagrams can be individually labeled with a descriptive, user-defined name.
Diagram layout	The grid, crosshair, axis labeling and diagram labeling can be switched on and off separately.
Persistence	50 ms to 50 s, or infinite
Zoom	vertical and horizontal; touch interface simplifies resize and drag operations on zoom window
Signal colors (waveform coding)	predefined or user-defined color tables for persistence display

History and segmented memory			
Acquisition memory	automatic	automatic setting of segment size and sample rate	
	manual	user-defined setting of segment size and sample rate	
Memory segmentation	function	memory segments for the acquisition	
	number of segments	record length	segments <sup>6)</sup> (up to)
		1 kpoints	1 048 575
		2 kpoints	524 287
		5 kpoints	262 143
		10 kpoints	131 071
		20 kpoints	65 535
		50 kpoints	32 767
		100 kpoints	16 383
		200 kpoints	9 361
		500 kpoints	4 095
		1 Mpoints	2 113
		2 Mpoints	1 056
		5 Mpoints	427
		10 Mpoints	213
		20 Mpoints	106
		50 Mpoints	41
		100 Mpoints	20
		200 Mpoints	9
		500 Mpoints	3
		1 Gpoints	1
	Segmentation is available for all analog and logic channels, protocol decoding and spectrum analysis.		
Fast-segmented mode	continuous recording of waveforms in acquisition memory without interruption due to visualization; for blind time between consecutive acquisitions, see Acquisition system		
History mode	function	The history mode is an always-on function and provides access to past acquisitions in the segmented memory.	
	timestamp resolution	1 ns	
	history player	replays the recorded waveforms; repetition possible; adjustable speed; manual switching to next/previous segment; numerical segment number input	
	analyze options	overlay all segments, average all segments, envelope all segments	

Mask testing		
Test definition	number of masks	up to 8 simultaneously
	source	acquired waveforms (input channels), math waveforms, reference waveforms, spectrum waveforms, XY plots
	fail condition	waveform hit
	test rate	up to 4 million waveforms/s
	action on error	acquisition stop, beep, save waveform, pulse on trigger out
Mask definition with segments	number of segments per mask test	up to 8
	segment definition	array of at least 3 points defines an inner region

<sup>6)</sup> With R&S®MXO5-B110 memory option. The maximum number of segments depends on the number of active channels and the bit resolution of the acquired data and, therefore, on the acquisition system settings such as decimation mode, use of waveform arithmetics or high definition (HD) mode. The maximum number of segments without the R&S®MXO5-B110 memory option is limited to 10 000.

Mask testing		
Result statistics	category	total completed acquisition, failed acquisition, passed acquisition, fail rate, overall test result (pass/fail)
Visualization options	waveform style	vectors, dots
	mask colors	predefined colors for mask without violation (translucent gray), mask with violation (translucent red)

Miscellaneous		
Remote control	web interface	full operation of the instrument's touch interface, keys and multifunction wheel via web browser
	VNC	control of the instrument through virtual network computing
	SCPI	standard instrument programming interface through VISA
	WebDAV	support for the web distributed authoring and versioning (WebDAV) protocol, which provides secure access through an application proxy
Languages	available languages for the user interface	English, German, French, Simplified Chinese, Traditional Chinese, Japanese, Russian, Spanish, Italian, Portuguese, Korean, Czech, Polish
	online help on the instrument	English

## Input and output

Front		
Channel inputs		BNC; for details, see Vertical system
	probe interface	auto detection of passive probes, Rohde & Schwarz active probe interface
Trigger input		BNC; for details, see Trigger system
	probe interface	auto detection of passive probes
Waveform generator outputs (requires R&S®MXO5-B6 option)		BNC; for details, see R&S®MXO5-B6, waveform generator, demo lugs and GND lug
Digital channel inputs	D15 to D8, D7 to D0	interface for R&S®RT-ZL04 logic probe
Probe compensation output	signal shape	rectangle, $V_{low} = 0\text{ V}$ , $V_{high} = 3.3\text{ V}$ amplitude $3.3\text{ V (}V_{pp}\text{)} \pm 5\%$ (meas.)
	frequency	1 kHz $\pm 1\%$ (meas.)
USB interfaces		3 $\times$ USB 3.1 Gen 1 ports, type A plug
Rear		
Trigger out		BNC; for details, see Trigger system
USB interface		1 $\times$ USB 3.1 Gen 1 port, type B plug
Reference input	connector	BNC
	impedance	50 $\Omega$ (nom.)
	input frequency	10 MHz ( $\pm 20$ ppm)
	sensitivity	$\geq -10\text{ dBm}$ into 50 $\Omega$ , $\leq 10\text{ dBm}$ at 10 MHz
Reference output	connector	BNC
	impedance	50 $\Omega$ (nom.)
	output signal	10 MHz (specified with timebase accuracy), 8 dBm (nom.)
Security slot		for standard Kensington style lock
VESA mount	via R&S®MXO5-Z7 VESA adapter	VESA compatibility mounting interface, 100 mm $\times$ 100 mm pattern size, according FDMI MIS-D, up to 14 kg with M4x10 screws
Right side		
Ground jack		connected to ground
USB interfaces		2 $\times$ USB 3.1 Gen 1 ports, type A plug
LAN interface		RJ-45 connector, supports 10/100/1000BASE-T
External monitor interface		HDMI 2.0 and DisplayPort++ 1.3, output of oscilloscope display

The terms HDMI and HDMI High-Definition Multimedia Interface, and the HDMI Logo are trademarks or registered trademarks of HDMI Licensing, LLC in the United States and other countries.



General data		
<b>Display</b>	type	15.6" LC TFT color display with capacitive touchscreen
	resolution	1920 × 1080 pixel (Full HD)
<b>Temperature</b>		
Temperature range	operating temperature range	0°C to +50°C
	storage temperature range	-40°C to +70°C
		in line with MIL-PRF-28800F section 4.5.5.1.1.1 class 3 tailored to +45°C for operation
Climatic resistance	damp heat	+25°C/+50°C at 85% relative humidity cyclic, in line with IEC 60068-2-30
<b>Altitude</b>		
Operating		up to 3000 m above sea level
Nonoperating		up to 4600 m above sea level
<b>Mechanical resistance</b>		
Vibration	sinusoidal	5 Hz to 150 Hz, max. 1.8 g at 55 Hz; 0.5 g from 55 Hz to 150 Hz, in line with EN 60068-2-6
		10 Hz to 55 Hz, in line with MIL-PRF-28800F, section 4.5.5.3.2, class 3
	random	8 Hz to 500 Hz, acceleration 1.2 g (RMS), in line with EN 60068-2-64
		5 Hz to 500 Hz, acceleration 2.058 g (RMS), in line with MIL-PRF-28800F, section 4.5.5.3.1, class 3
Shock		40 g shock spectrum, in line with MIL-STD-810G, method no. 516.6, procedure I
		30 g functional shock, half sine, duration 11 ms, in line with MIL-PRF-28800F, section 4.5.5.4.1
<b>Electromagnetic compatibility (EMC)</b>		
RF emissions		in line with CISPR 11/EN 55011 group 1, class A (for a shielded test setup); the instrument complies with the emission requirements stipulated by EN 55011, EN 61326-1 and EN 61326-2-1 class A, making the instrument suitable for use in industrial environments
Immunity		in line with IEC/EN 61326-1 table 2, immunity test requirements for industrial environment <sup>7)</sup>
<b>Certifications</b>		VDE, <sub>C</sub> CSA <sub>US</sub> , KC
<b>Calibration interval</b>		1 year
<b>Power supply</b>		
AC supply		100 V to 240 V ± 10% at 50 Hz to 60 Hz and 400 Hz ± 5%, max. 4 A to 2.5 A, in line with MIL-PRF 28800F, section 3.5
Power consumption	standby mode	1.6 W
	all channels on, without probes	180 W (typ.)
	max.	360 W
Safety		in line with IEC 61010-1, IEC 61010-2-030, CAN/CSA-C22.2 no. 61010-1, UL 61010-1, CAN/CSA C22.2 no. 61010-2-030
<b>Mechanical data</b>		
Dimensions	W × H × D	445 mm × 314 mm × 153 mm (17.51 in × 12.36 in × 6.02 in)
Weight	without options, nominal	9.0 kg (19.85 lb)
Rackmount height	with R&S®ZZA-MXO5 rackmount kit	8 HU

<sup>7)</sup> Test criterion is displayed noise level within ±1 div for an input sensitivity of 5 mV/div.

# ORDERING INFORMATION

Designation	Type	Order No.
<b>MXO 5 series, base models</b>		
Oscilloscope, 350 MHz, 4 channels	MXO 54	1802.1008K04
Oscilloscope, 100 MHz, 8 channels	MXO 58	1802.1008K08
Base unit (including standard accessories: 700 MHz passive probe (10:1) per channel, accessories bag, quick start guide, power cord)		
<b>Choose your bandwidth upgrade</b>		
Upgrade of MXO 54 to 500 MHz bandwidth	R&S®MXO5-B245	1802.0676.02
Upgrade of MXO 54 to 1 GHz bandwidth	R&S®MXO5-B2410	1802.0682.02
Upgrade of MXO 54 to 2 GHz bandwidth	R&S®MXO5-B2420	1802.0699.02
Upgrade of MXO 58 to 200 MHz bandwidth	R&S®MXO5-B282	1802.0701.02
Upgrade of MXO 58 to 350 MHz bandwidth	R&S®MXO5-B283	1802.0718.02
Upgrade of MXO 58 to 500 MHz bandwidth	R&S®MXO5-B285	1802.0724.02
Upgrade of MXO 58 to 1 GHz bandwidth	R&S®MXO5-B2810	1802.0730.02
Upgrade of MXO 58 to 2 GHz bandwidth	R&S®MXO5-B2820	1802.0747.02
<b>Choose your options</b>		
Mixed signal option, for MXO 5 series with 16 digital channels	R&S®MXO5-B1	1802.0660.02
Arbitrary waveform generator, 100 MHz, 2 analog channels	R&S®MXO5-B6	1802.0753.02
Additional M.2 SSD	R&S®MXO5-B19	1803.0205.02
Memory option 1 Gpoints	R&S®MXO5-B110	1803.0211.02
Power analysis	R&S®MXO5-K31	1802.0799.02
Frequency response analysis	R&S®MXO5-K36	1802.1943.02
Low speed serial buses (I <sup>2</sup> C/SPI/QuadSPI/UART/RS-232/RS-422/RS-485)	R&S®MXO5-K510	1802.1243.02
Automotive protocols (CAN/CAN FD/CAN XL/LIN/SENT)	R&S®MXO5-K520	1802.1920.02
Aerospace protocols (ARINC 429, MIL-STD-1553)	R&S®MXO5-K530	1802.1266.02
MIPI low speed protocols (SPMI/REFE)	R&S®MXO5-K550	1802.1282.02
Automotive Ethernet protocols (10BASE-T1S, 100BASE-T1)	R&S®MXO5-K560	1802.1250.02
Application bundle, consists of the following options: R&S®MXO5-B6, R&S®MXO5-K31, R&S®MXO5-K36, R&S®MXO5-K510, R&S®MXO5-K520	R&S®MXO5-PK1	1803.0257.02
R&S®ScopeSuite+, base option	R&S®SPLUS	1804.8800.02
R&S®ScopeSuite+, 100BASE-T1 compliance automotive Ethernet compliance test	R&S®SPLUS-K24	1804.8774.02
<b>Choose your additional probes</b>		
<b>Single-ended passive probes</b>		
700 MHz, 10 MΩ, 10:1, 400 V, 9.5 pF, 2.5 mm	R&S®RT-ZP11	1803.0005.02
500 MHz, 10 MΩ, 10:1, 400 V, 9.5 pF, 2.5 mm	R&S®RT-ZP10	1409.7550.00
500 MHz, 10 MΩ, 10:1, 300 V, 10 pF, 5 mm	R&S®RT-ZP05S	1333.2401.02
38 MHz, 1 MΩ, 1:1, 55 V, 39 pF, 2.5 mm	R&S®RT-ZP1X	1333.1370.02
<b>Active broadband probes: single-ended</b>		
1.0 GHz, active, 1 MΩ, Rohde&Schwarz probe interface	R&S®RT-ZS10E	1418.7007.02
1.0 GHz, active, 1 MΩ, R&S®ProbeMeter, micro button, Rohde&Schwarz probe interface	R&S®RT-ZS10	1410.4080.02
1.5 GHz, active, 1 MΩ, R&S®ProbeMeter, micro button, Rohde&Schwarz probe interface	R&S®RT-ZS20	1410.3502.02
<b>Active broadband probes: differential</b>		
1.0 GHz, active, differential, 1 MΩ, R&S®ProbeMeter, micro button, incl. 10:1 external attenuator, 1 MΩ, 60 V DC, 42.4 V AC (peak), Rohde&Schwarz probe interface	R&S®RT-ZD10	1410.4715.02
1.5 GHz, active, differential, 1 MΩ, R&S®ProbeMeter, micro button, Rohde&Schwarz probe interface	R&S®RT-ZD20	1410.4409.02
<b>Modular broadband probes</b>		
Probe amplifier module, 1.5 GHz, 10:1 or 2:1, 400 kΩ (differential mode), 200 kΩ (single-ended mode)	R&S®RT-ZM15	1800.4700.02
Probe amplifier module, 3 GHz, 10:1 or 2:1, 400 kΩ (differential mode), 200 kΩ (single-ended mode)	R&S®RT-ZM30	1419.3005.02
<b>Power rail probe</b>		
2.0 GHz, 1:1, 50 kΩ, ±0.85 V, ±60 V offset, Rohde&Schwarz probe interface	R&S®RT-ZPR20	1800.5006.02
<b>High voltage probes: passive</b>		
250 MHz, 100:1, 100 MΩ, 850 V, 6.5 pF	R&S®RT-ZH03	1333.0873.02
400 MHz, 100:1, 50 MΩ, 1000 V, 7.5 pF	R&S®RT-ZH10	1409.7720.02
400 MHz, 1000:1, 50 MΩ, 1000 V, 7.5 pF	R&S®RT-ZH11	1409.7737.02

Designation	Type	Order No.
<b>High voltage probes: differential</b>		
200 MHz, 250:1/25:1, 5 MΩ, 750 V (peak), 300 V CAT III, Rohde & Schwarz probe interface	R&S®RT-ZHD07	1800.2307.02
100 MHz, 500:1/50:1, 10 MΩ, 1500 V (peak), 1000 V CAT III, Rohde & Schwarz probe interface	R&S®RT-ZHD15	1800.2107.02
200 MHz, 500:1/50:1, 10 MΩ, 1500 V (peak), 1000 V CAT III, Rohde & Schwarz probe interface	R&S®RT-ZHD16	1800.2207.02
100 MHz, 1000:1/100:1, 40 MΩ, 6000 V (peak), 1000 V CAT III, Rohde & Schwarz probe interface	R&S®RT-ZHD60	1800.2007.02
<b>Current probes</b>		
20 kHz, AC/DC, 0.01 V/A and 0.001 V/A, ±200 A and ±2000 A, BNC interface	R&S®RT-ZC02	1333.0850.02
100 kHz, AC/DC, 0.1 V/A, 30 A, BNC interface	R&S®RT-ZC03	1333.0844.02
2 MHz, AC/DC, 0.01 V/A, 500 A (RMS), Rohde & Schwarz probe interface	R&S®RT-ZC05B	1409.8204.02
10 MHz, AC/DC, 0.01 V/A, 150 A (RMS), BNC interface	R&S®RT-ZC10	1409.7750K02
10 MHz, AC/DC, 0.01 V/A, 150 A (RMS), Rohde & Schwarz probe interface	R&S®RT-ZC10B	1409.8210.02
50 MHz, AC/DC, 0.1 V/A, 30 A (RMS), Rohde & Schwarz probe interface	R&S®RT-ZC15B	1409.8227.02
100 MHz, AC/DC, 0.1 V/A, 30 A (RMS), BNC interface	R&S®RT-ZC20	1409.7766K02
100 MHz, AC/DC, 0.1 V/A, 30 A (RMS), Rohde & Schwarz probe interface	R&S®RT-ZC20B	1409.8233.02
120 MHz, AC/DC, 1 V/A, 5 A (RMS), BNC interface	R&S®RT-ZC30	1409.7772K02
<b>EMC near-field probe</b>		
Probe set for E and H near-field measurements, 30 MHz to 3 GHz	R&S®HZ-15	1147.2736.02
<b>Logic probe<sup>1)</sup></b>		
400 MHz logic probe, 8 channels	R&S®RT-ZL04	1333.0721.02
<b>Probe accessories</b>		
Accessory set for R&S®RT-ZP11 passive probe (2.5 mm probe tip)	R&S®RT-ZA1	1409.7566.00
Power supply for R&S®RT-ZC10/-ZC20/-ZC30 current probes	R&S®RT-ZA13	1409.7789.02
External attenuator 10:1, 2.0 GHz, 1.3 pF, 60 V DC, 42.4 V AC (peak), for R&S®RT-ZD20/-ZD30 probes	R&S®RT-ZA15	1410.4744.02
Probe pouch for the logic probes	R&S®RT-ZA19	1335.7875.02
Power deskew and calibration test fixture	R&S®RT-ZF20	1800.0004.02
3D positioner with central tensioning knob for easy clamping and positioning of probes (span width: 200 mm, clamping range: 15 mm)	R&S®RT-ZAP	1326.3641.02
Bipod probe positioner	R&S®RT-ZA29	1801.4803.02
<b>Choose your accessories</b>		
Rackmount kit, for MXO 5 series with 8 HU	R&S®ZZA-MXO5	1802.3181.02
Front cover	R&S®MXO5-Z1	1803.0240.02
Soft case (W × H × D: 550 mm × 300 mm × 340 mm)	R&S®MXO5-Z3	1803.0228.02
Transit case (W × H × D: 613 mm × 478 mm × 337 mm)	R&S®MXO5-Z4	1803.1560.02
VESA adapter	R&S®MXO5-Z7	1803.0457.02
VESA mount (compatible with standard 100 mm × 100 mm pattern)	Choose industry standard mounts according to FDMI MIS-D, up to 14 kg with M4x10 screws	

Service at Rohde & Schwarz

## YOU'RE IN GREAT HANDS

	SERVICE PLANS	ON DEMAND
Calibration	Up to five years <sup>1)</sup>	Pay per calibration
Warranty and repair	Up to five years <sup>1)</sup>	Standard price repair

<sup>1)</sup> For extended periods, contact your Rohde & Schwarz sales office.

Instrument management made easy

The R&S®InstrumentManager makes it easy to register and manage your instruments. It lets you schedule calibration dates and book services.

Find out more about our service portfolio under:



<sup>1)</sup> The R&S®MXO5-B1 mixed signal option contains two R&S®RT-ZL04 logic probes.

**Service at Rohde & Schwarz**  
**You're in great hands**

- ▶ Worldwide
- ▶ Local and personalized
- ▶ Customized and flexible
- ▶ Uncompromising quality
- ▶ Long-term dependability

**MAKE IDEAS REAL**  
and join our experts team  
at Rohde & Schwarz.



**dataTec**

Mess- und Prüftechnik. Die Experten.

**Ihr Ansprechpartner /  
Your Partner:**

**dataTec AG**

E-Mail: [info@datatec.eu](mailto:info@datatec.eu)

>>> [www.datatec.eu](http://www.datatec.eu)

**Rohde & Schwarz**

The Rohde & Schwarz technology group is among the trailblazers when it comes to paving the way for a safer and connected world with its leading solutions in test & measurement, technology systems and networks & cybersecurity. Founded 90 years ago, the group is a reliable partner for industry and government customers around the globe. The independent company is headquartered in Munich, Germany and has an extensive sales and service network with locations in more than 70 countries.

[www.rohde-schwarz.com](http://www.rohde-schwarz.com)

**Sustainable product design**

- ▶ Environmental compatibility and eco-footprint
- ▶ Energy efficiency and low emissions
- ▶ Longevity and optimized total cost of ownership

Certified Quality Management  
**ISO 9001**

Certified Environmental Management  
**ISO 14001**

**Rohde & Schwarz training**

[www.training.rohde-schwarz.com](http://www.training.rohde-schwarz.com)

**Rohde & Schwarz customer support**

[www.rohde-schwarz.com/support](http://www.rohde-schwarz.com/support)

